

AR2050V

SECURE VPN ROUTER

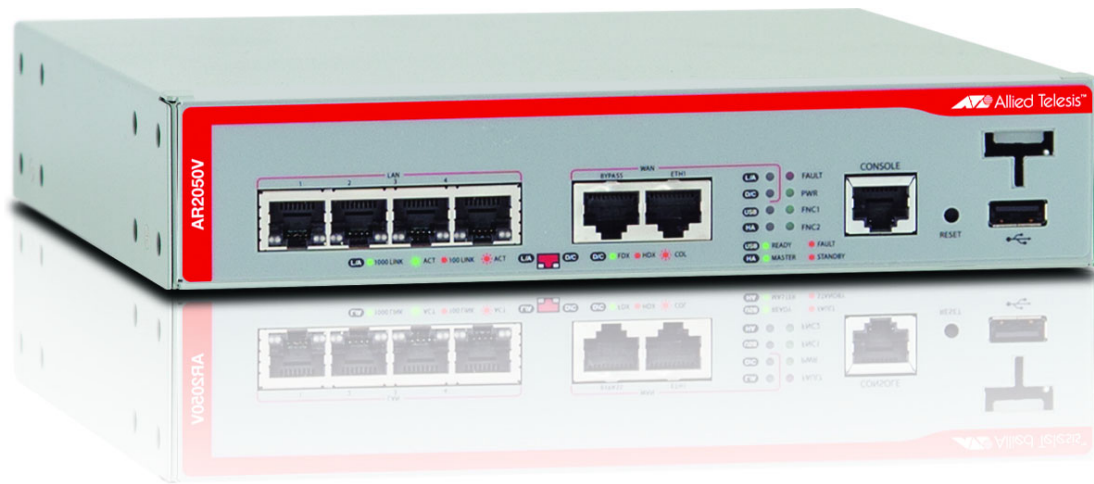

Command Reference for AlliedWare Plus™ Version 5.5.2-1.x

Acknowledgments

This product includes software developed by the University of California, Berkeley and its contributors.
Copyright ©1982, 1986, 1990, 1991, 1993 The Regents of the University of California.
All rights reserved.

This product includes software developed by the OpenSSL Project for use in the OpenSSL Toolkit. For information about this see www.openssl.org/
Copyright (c) 1998-2019 The OpenSSL Project
Copyright (c) 1995-1998 Eric A. Young, Tim J. Hudson
All rights reserved.

For the full list of acknowledgments, and respective copyright notices, run the **show version** command on your device.

This product includes software licensed under v2 and v3 of the GNU General Public License, available from: www.gnu.org/licenses/gpl2.html and www.gnu.org/licenses/gpl.html respectively.

Source code for all GPL licensed software in this product can be obtained from the Allied Telesis GPL Code Download Center at: www.alliedtelesis.com/support/

Allied Telesis is committed to meeting the requirements of the open source licenses including the GNU General Public License (GPL) and will make all required source code available.

If you would like a copy of the GPL source code contained in Allied Telesis products, please send us a request by registered mail including a check for US\$15 to cover production and shipping costs and a CD with the GPL code will be mailed to you.

GPL Code Request
Allied Telesis Labs (Ltd)
PO Box 8011
Christchurch
New Zealand

Allied Telesis, AlliedWare Plus, Allied Telesis Management Framework, EPSRing, SwitchBlade, VCStack, and VCStack Plus are trademarks or registered trademarks in the United States and elsewhere of Allied Telesis, Inc.

Microsoft and Internet Explorer are registered trademarks of Microsoft Corporation. All other product names, company names, logos or other designations mentioned herein may be trademarks or registered trademarks of their respective owners.

© 2022 Allied Telesis, Inc.

All rights reserved. No part of this publication may be reproduced without prior written permission from Allied Telesis, Inc.

Allied Telesis, Inc. reserves the right to make changes in specifications and other information contained in this document without prior written notice. The information provided herein is subject to change without notice. In no event shall Allied Telesis, Inc. be liable for any incidental, special, indirect, or consequential damages whatsoever, including but not limited to lost profits, arising out of or related to this manual or the information contained herein, even if Allied Telesis, Inc. has been advised of, known, or should have known, the possibility of such damages.

Contents

PART 1:	Setup and Troubleshooting	126
Chapter 1:	CLI Navigation Commands	127
	Introduction	127
	configure terminal	128
	disable (Privileged Exec mode)	129
	do	130
	enable (Privileged Exec mode)	131
	end	133
	exit	134
	help	135
	logout	136
	show history	137
Chapter 2:	Device GUI and Vista Manager EX Commands	138
	Introduction	138
	atmf topology-gui enable	139
	http log webapi-requests	140
	http client vrf	141
	http vrf	142
	http port	143
	http secure-port	144
	http trustpoint	145
	log event-host	147
	service http	148
	show http	149
	show http client	150
	update webgui now	151
Chapter 3:	File and Configuration Management Commands	152
	Introduction	152
	autoboot enable	155
	boot config-file	156

boot config-file backup	158
boot system	159
boot system backup	161
cd	162
copy (filename)	163
copy debug	165
copy running-config	166
copy startup-config	167
copy zmodem	168
create autoboot	169
delete	170
delete debug	171
dir	172
edit	174
edit (filename)	175
erase factory-default	176
erase startup-config	177
ip tftp source-interface	178
ip tftp vrf	179
ipv6 tftp source-interface	180
mkdir	181
move	182
move debug	183
pwd	184
rmdir	185
show autoboot	186
show boot	187
show file	189
show file systems	190
show running-config	192
show running-config interface	195
show startup-config	198
show version	199
unmount	200
write file	201
write memory	202
write terminal	203

Chapter 4: User Access Commands 204

Introduction	204
aaa authentication enable default local	206
aaa local authentication attempts lockout-time	207
aaa local authentication attempts max-fail	208
aaa login fail-delay	209
clear aaa local user lockout	210
clear line console	211
clear line vty	212
enable password	213
enable secret (deprecated)	215
exec-timeout	216
flowcontrol hardware (asyn/console)	218
length (asyn)	220
line	221

	privilege level	223
	security-password history	224
	security-password forced-change	225
	security-password lifetime	226
	security-password min-lifetime-enforce	227
	security-password minimum-categories	228
	security-password minimum-length	229
	security-password reject-expired-pwd	230
	security-password warning	231
	service advanced-vty	232
	service password-encryption	233
	service telnet	234
	show aaa local user locked	235
	show privilege	236
	show security-password configuration	237
	show security-password user	238
	show telnet	239
	show users	240
	telnet	241
	telnet server	242
	terminal length	243
	terminal resize	244
	username	245
Chapter 5:	Update Manager Commands	247
	Introduction	247
	show resource	248
	update now	249
	update webgui now	250
Chapter 6:	Web Redirect Commands	251
	Introduction	251
	browser-only (web-redirect)	252
	enable (web-redirect)	253
	exclude app	254
	exclude dst-ip	256
	exclude ip	258
	exclude mac	259
	exclude url	260
	idle-time (web-redirect)	262
	mode (web-redirect)	264
	proxy-host (web-redirect)	266
	repeat-time (web-redirect)	268
	server-url (web-redirect)	269
	show running-config web-redirect	270
	show web-redirect	271
	web-redirect	272
Chapter 7:	System Configuration and Monitoring Commands	273
	Introduction	273
	banner display external-manager	275
	banner exec	276

banner external-manager	278
banner login (system)	280
banner motd	282
clock set	284
clock summer-time date	285
clock summer-time recurring	287
clock timezone	289
debug core-file	290
hostname	291
max-fib-routes	293
max-static-routes	295
no debug all	296
reboot	298
receive-packet-scheduler	299
reload	301
show banner external-manager	302
show clock	303
show cpu	305
show cpu history	308
show debugging	310
show interface memory	311
show memory	313
show memory allocations	315
show memory history	317
show memory pools	318
show memory shared	319
show process	320
show reboot history	322
show router-id	323
show system	324
show system environment	325
show system environment counters	326
show system interrupts	328
show system mac	329
show system pci device	330
show system pci tree	331
show system serialnumber	332
show tech-support	333
speed (asyn)	335
terminal monitor	337
undebg all	338

Chapter 8:	Logging Commands	339
	Introduction	339
	clear exception log	342
	clear log	343
	clear log buffered	344
	clear log external	345
	clear log permanent	346
	connection-log events	347
	copy buffered-log	348
	copy permanent-log	349
	default log buffered	350

default log console	351
default log email	352
default log external	353
default log host	354
default log monitor	355
default log permanent	356
log buffered	357
log buffered (filter)	358
log buffered exclude	361
log buffered size	364
log console	365
log console (filter)	366
log console exclude	369
log date-format	372
log email	373
log email (filter)	374
log email exclude	377
log email time	380
log external	382
log external (filter)	384
log external exclude	387
log external rotate	390
log external size	392
log facility	393
log host	395
log host (filter)	397
log host exclude	401
log host source	404
log host startup-delay	405
log host time	407
log monitor (filter)	409
log monitor exclude	412
log permanent	415
log permanent (filter)	416
log permanent exclude	419
log permanent size	422
log-rate-limit nsm	423
log trustpoint	424
log url-requests	425
show connection-log events	426
show counter log	427
show exception log	428
show log	429
show log config	431
show log external	433
show log permanent	434
show running-config log	435
unmount	436

Chapter 9:	Scripting Commands	437
	Introduction	437
	activate	438
	echo	439

	wait	440
Chapter 10:	Interface Commands	441
	Introduction	441
	description (interface)	442
	interface (to configure)	443
	ip tcp adjust-mss	445
	ipv6 tcp adjust-mss	447
	mru jumbo	449
	mtu	450
	service statistics interfaces counter	452
	show interface	453
	show interface brief	457
	show interface memory	458
	show interface status	460
	shutdown	462
Chapter 11:	3G and 4G USB Cellular Modem Commands	463
	Introduction	463
	apn	464
	chat-script	466
	cid	467
	encapsulation ppp	468
	show cellular	470
	show system usb	473
	usb mode-switch	475
Chapter 12:	Port Mirroring Commands	477
	Introduction	477
	mirror interface	478
	show mirror	480
	show mirror interface	481
PART 2:	Interfaces and Layer 2	482
Chapter 13:	Switching Commands	483
	Introduction	483
	backpressure	485
	clear mac address-table dynamic	487
	clear mac address-table static	488
	clear port counter	489
	debug platform packet	490
	duplex	492
	flowcontrol (switch port)	493
	linkflap action	495
	mac address-table acquire	496
	mac address-table ageing-time	497
	mac address-table static	498
	platform multicast-ratelimit	499
	polarity	500
	show debugging platform packet	501

	show flowcontrol interface	502
	show interface err-disabled	503
	show interface switchport	504
	show mac address-table	505
	show platform	507
	show platform port	509
	show storm-control	511
	speed	512
	storm-control level	514
	undebug platform packet	515
Chapter 14:	Bridging Commands	516
	Introduction	516
	ageing-time	518
	bridge	519
	bridge-group	520
	clear mac-filter counter	522
	default-action	523
	default-protocol-action	525
	l3-filtering enable	526
	mac-filter-group egress	527
	mac-filter	528
	mac-filter-group	529
	mac-learning	530
	protocol ethii (macfilter)	531
	protocol novell (macfilter)	533
	protocol sap (macfilter)	535
	protocol snap (macfilter)	537
	rule (macfilter)	539
	rule ip (macfilter)	541
	rule ipv6 (macfilter)	543
	show bridge	545
	show bridge macaddr	547
	show mac-filter	548
Chapter 15:	VLAN Commands	550
	Introduction	550
	show vlan	551
	switchport access vlan	552
	switchport mode access	553
	switchport mode trunk	554
	switchport trunk allowed vlan	555
	switchport trunk native vlan	558
	switchport voice dscp	559
	switchport voice vlan	560
	switchport voice vlan priority	562
	vlan	563
	vlan database	565
Chapter 16:	Spanning Tree Commands	566
	Introduction	566
	clear spanning-tree statistics	568

clear spanning-tree detected protocols (RSTP and MSTP)	569
debug mstp (RSTP and STP)	570
instance priority (MSTP)	574
instance vlan (MSTP)	576
region (MSTP)	578
revision (MSTP)	579
show debugging mstp	580
show spanning-tree	581
show spanning-tree brief	584
show spanning-tree mst	585
show spanning-tree mst config	586
show spanning-tree mst detail	587
show spanning-tree mst detail interface	589
show spanning-tree mst instance	591
show spanning-tree mst instance interface	592
show spanning-tree mst interface	593
show spanning-tree statistics	594
show spanning-tree statistics instance	596
show spanning-tree statistics instance interface	597
show spanning-tree statistics interface	599
show spanning-tree vlan range-index	601
spanning-tree autoedge (RSTP and MSTP)	602
spanning-tree cisco-interoperability (MSTP)	603
spanning-tree edgeport (RSTP and MSTP)	604
spanning-tree enable	605
spanning-tree errdisable-timeout enable	607
spanning-tree errdisable-timeout interval	608
spanning-tree force-version	609
spanning-tree forward-time	610
spanning-tree guard root	611
spanning-tree hello-time	612
spanning-tree link-type	613
spanning-tree max-age	614
spanning-tree max-hops (MSTP)	615
spanning-tree mode	616
spanning-tree mst configuration	617
spanning-tree mst instance	618
spanning-tree mst instance path-cost	619
spanning-tree mst instance priority	621
spanning-tree mst instance restricted-role	622
spanning-tree mst instance restricted-tcn	624
spanning-tree path-cost	625
spanning-tree portfast (STP)	626
spanning-tree portfast bpdu-filter	628
spanning-tree portfast bpdu-guard	630
spanning-tree priority (bridge priority)	632
spanning-tree priority (port priority)	633
spanning-tree restricted-role	634
spanning-tree restricted-tcn	635
spanning-tree transmit-holdcount	636
undebg mstp	637

Chapter 17: Link Aggregation Commands 638

	Introduction	638
	channel-group	640
	clear lacp counters	642
	debug lacp	643
	lacp global-passive-mode enable	644
	lacp port-priority	645
	lacp system-priority	646
	lacp timeout	647
	show debugging lacp	649
	show diagnostic channel-group	650
	show etherchannel	651
	show etherchannel detail	652
	show etherchannel summary	653
	show lacp sys-id	654
	show lacp-counter	655
	show port etherchannel	656
	show static-channel-group	657
	static-channel-group	658
	undebg lacp	660
Chapter 18:	802.1Q Encapsulation Commands	661
	Introduction	661
	encapsulation dot1q	662
Chapter 19:	PPP Commands	664
	Introduction	664
	debug ppp	666
	encapsulation ppp	669
	interface (PPP)	671
	ip address negotiated	672
	ip tcp adjust-mss	674
	ip unnumbered	676
	ipv6 tcp adjust-mss	678
	keepalive (PPP)	680
	mtu (PPP)	682
	peer default ip address	683
	peer neighbor-route	685
	ppp authentication	687
	ppp authentication refuse	689
	ppp hostname	691
	ppp ipcp dns	693
	ppp ipcp dns suffix-list	695
	ppp ipcp ip-override	697
	ppp password	698
	ppp service-name (PPPoE)	699
	ppp timeout idle	700
	ppp username	701
	show debugging ppp	702
	show interface (PPP)	703
	undebg ppp	707
Chapter 20:	PPP over Ethernet (PPPoE) Commands	708

Introduction	708
clear pppoe-ac statistics	710
client (pppoe-relay)	711
debug pppoe-ac	712
destination l2tp	713
l2tp peer-address dns-lookup	714
l2tp peer-address radius-lookup group	716
l2tp peer-address static	717
l2tp profile	719
max-sessions	721
ppp-auth-protocol	722
pppoe-ac	723
pppoe-ac-service	724
pppoe-relay	725
proxy-auth	726
server (pppoe-relay)	727
service-name	728
show debugging pppoe ac	730
show pppoe-ac config-check	731
show pppoe-ac connections	733
show pppoe-ac statistics	735
show running-config pppoe-ac	738
show running-config pppoe-relay	739
timeout (pppoe-relay)	740

PART 3: Routing 741

Chapter 21: IP Addressing and Protocol Commands 742

Introduction	742
arp-aging-timeout	744
arp	745
arp log	747
arp opportunistic-nd	750
arp-loose-check	752
arp-reply-bc-dmac	754
clear arp-cache	755
debug ip packet interface	757
ip address (IP Addressing and Protocol)	759
ip directed-broadcast	761
ip forwarding	763
ip forward-protocol udp	764
ip gratuitous-arp-link	766
ip helper-address	768
ip icmp error-interval	770
ip icmp-timestamp	771
ip limited-local-proxy-arp	772
ip local-proxy-arp	774
ip proxy-arp	775
ip redirects	776
ip tcp synack-retries	777
ip tcp timeout established	778
ip tcp-timestamp	779

ip unreachable	780
local-proxy-arp	782
optimistic-nd	783
ping	784
show arp	786
show debugging ip packet	788
show ip flooding-nexthops	789
show ip forwarding	790
show ip interface	791
show ip interface vrf	792
show ip sockets	794
show ip traffic	797
tcpdump	799
traceroute	800
undebug ip packet interface	801

Chapter 22: Domain Name Service (DNS) Commands 802

Introduction	802
accept-invalid-sslcert	805
clear ip dns forwarding cache	806
custom-failure	807
custom-success	808
ddns enable	809
ddns-update-method	810
ddns-update now	812
debug ddns	813
debug ip dns forwarding	814
description (domain-list)	815
domain	816
expect-html-response	817
follow-redirects	818
get-before-submit	819
get-params	820
host-name (ddns-update-method)	821
ip ddns-update-method	822
ip dns forwarding	823
ip dns forwarding cache	824
ip dns forwarding dead-time	826
ip dns forwarding domain-list	827
ip dns forwarding retry	828
ip dns forwarding source-interface	829
ip dns forwarding timeout	830
ip domain-list	831
ip domain-lookup	832
ip domain-name	834
ip name-server	835
ip name-server preferred-order	837
ipv6 ddns-update-method	838
obey-form	839
password (ddns-update-method)	840
ppp ipcp dns	841
ppp ipcp dns suffix-list	843
retry-interval	845

show ddns-update-method status	846
show debugging ip dns forwarding	847
show hosts	848
show ip dns forwarding	849
show ip dns forwarding cache	850
show ip dns forwarding server	852
show ip domain-list	854
show ip domain-name	855
show ip name-server	856
suppress-ipv4-updates	858
undebg ddns	859
update-interval (ddns-update-method)	860
update-url (ddns-update-method)	861
use-ipv4-for-ipv6-updates	864
username (ddns-update-method)	865

Chapter 23: IPv6 Commands 866

Introduction	866
clear ipv6 neighbors	868
ipv6 address	869
ipv6 address autoconfig	871
ipv6 address suffix	873
ipv6 enable	874
ipv6 eui64-linklocal	876
ipv6 forwarding	877
ipv6 icmp error-interval	878
ipv6 multicast forward-slow-path-packet	879
ipv6 multihoming	880
ipv6 nd accept-ra-default-routes	881
ipv6 nd accept-ra-pinfo	882
ipv6 nd current-hoplimit	883
ipv6 nd dns search-list	885
ipv6 nd dns-server	886
ipv6 nd managed-config-flag	888
ipv6 nd minimum-ra-interval	889
ipv6 nd other-config-flag	891
ipv6 nd prefix	892
ipv6 nd proxy interface	894
ipv6 nd ra-interval	896
ipv6 nd ra-lifetime	897
ipv6 nd reachable-time	899
ipv6 nd retransmission-time	901
ipv6 nd route-information	903
ipv6 nd router-preference	904
ipv6 nd suppress-ra	905
ipv6 neighbor	906
ipv6 opportunistic-nd	907
ipv6 route	908
ipv6 unreachable	910
optimistic-nd	911
ping ipv6	912
show ipv6 forwarding	914
show ipv6 interface	915

	show ipv6 neighbors	917
	show ipv6 route	918
	show ipv6 route summary	920
	traceroute ipv6	921
Chapter 24:	Routing Commands	922
	Introduction	922
	ip route	923
	ipv6 route	926
	max-fib-routes	928
	max-static-routes	930
	maximum-paths	931
	show ip route	932
	show ip route database	935
	show ip route summary	938
	show ipv6 route	940
	show ipv6 route summary	942
Chapter 25:	RIP Commands	943
	Introduction	943
	accept-lifetime	945
	address-family ipv4 (RIP)	947
	alliedware-behavior	948
	cisco-metric-behavior (RIP)	950
	clear ip rip route	951
	debug rip	953
	default-information originate (RIP)	954
	default-metric (RIP)	955
	distance (RIP)	956
	distribute-list (RIP)	957
	fullupdate (RIP)	958
	ip summary-address rip	959
	ip prefix-list	960
	ip rip authentication key-chain	962
	ip rip authentication mode	964
	ip rip authentication string	966
	ip rip receive-packet	968
	ip rip receive version	969
	ip rip send-packet	970
	ip rip send version	971
	ip rip send version 1-compatible	973
	ip rip split-horizon	974
	key	975
	key chain	976
	key-string	977
	maximum-prefix	978
	neighbor (RIP)	979
	network (RIP)	980
	passive-interface (RIP)	982
	recv-buffer-size (RIP)	983
	redistribute (RIP)	984
	restart rip graceful	986

rip restart grace-period	987
route (RIP)	988
router rip	989
send-lifetime	990
show debugging rip	992
show ip prefix-list	993
show ip protocols rip	994
show ip rip	995
show ip rip database	996
show ip rip interface	997
show ip rip vrf database	998
show ip rip vrf interface	999
timers (RIP)	1000
undebg rip	1002
version (RIP)	1003

Chapter 26: RIPng for IPv6 Commands 1005

Introduction	1005
aggregate-address (IPv6 RIPng)	1007
clear ipv6 rip route	1008
debug ipv6 rip	1009
default-information originate (IPv6 RIPng)	1010
default-metric (IPv6 RIPng)	1011
distribute-list (IPv6 RIPng)	1012
ipv6 prefix-list	1013
ipv6 rip metric-offset	1015
ipv6 rip split-horizon	1017
ipv6 router rip	1018
neighbor (IPv6 RIPng)	1019
passive-interface (IPv6 RIPng)	1020
rcv-buffer-size (IPv6 RIPng)	1021
redistribute (IPv6 RIPng)	1022
route (IPv6 RIPng)	1023
router ipv6 rip	1024
show debugging ipv6 rip	1025
show ipv6 prefix-list	1026
show ipv6 protocols rip	1027
show ipv6 rip	1028
show ipv6 rip database	1029
show ipv6 rip interface	1030
timers (IPv6 RIPng)	1031
undebg ipv6 rip	1032

Chapter 27: OSPF Commands 1033

Introduction	1033
area default-cost	1036
area authentication	1037
area filter-list	1038
area nssa	1039
area range	1041
area stub	1043
area virtual-link	1044

auto-cost reference bandwidth	1047
bandwidth	1049
capability opaque	1050
capability restart	1051
clear ip ospf process	1052
compatible rfc1583	1053
debug ospf events	1054
debug ospf ifsm	1055
debug ospf lsa	1056
debug ospf n fsm	1057
debug ospf nsm	1058
debug ospf packet	1059
debug ospf route	1060
default-information originate	1061
default-metric (OSPF)	1062
distance (OSPF)	1063
distribute-list (OSPF)	1065
enable db-summary-opt	1067
host area	1068
ip ospf authentication	1069
ip ospf authentication-key	1070
ip ospf cost	1071
ip ospf database-filter	1072
ip ospf dead-interval	1073
ip ospf disable all	1074
ip ospf hello-interval	1075
ip ospf message-digest-key	1076
ip ospf mtu	1078
ip ospf mtu-ignore	1079
ip ospf network	1080
ip ospf priority	1081
ip ospf resync-timeout	1082
ip ospf retransmit-interval	1083
ip ospf transmit-delay	1084
max-concurrent-dd	1085
maximum-area	1086
neighbor (OSPF)	1087
network area	1088
ospf abr-type	1090
ospf restart grace-period	1091
ospf restart helper	1092
ospf router-id	1094
overflow database	1095
overflow database external	1096
passive-interface (OSPF)	1097
redistribute (OSPF)	1098
restart ospf graceful	1100
router ospf	1101
router-id	1103
show debugging ospf	1104
show ip ospf	1105
show ip ospf border-routers	1108
show ip ospf database	1109

show ip ospf database asbr-summary	1111
show ip ospf database external	1112
show ip ospf database network	1114
show ip ospf database nssa-external	1115
show ip ospf database opaque-area	1117
show ip ospf database opaque-as	1118
show ip ospf database opaque-link	1119
show ip ospf database router	1120
show ip ospf database summary	1122
show ip ospf interface	1125
show ip ospf neighbor	1126
show ip ospf route	1128
show ip ospf virtual-links	1129
show ip protocols ospf	1130
summary-address	1131
timers spf exp	1132
undebug ospf events	1133
undebug ospf ifsm	1134
undebug ospf lsa	1135
undebug ospf nfsm	1136
undebug ospf nsm	1137
undebug ospf packet	1138
undebug ospf route	1139

Chapter 28: OSPFv3 for IPv6 Commands 1140

Introduction	1140
abr-type	1143
area authentication ipsec spi	1144
area default-cost (IPv6 OSPF)	1146
area encryption ipsec spi esp	1147
area range (IPv6 OSPF)	1150
area stub (IPv6 OSPF)	1152
area virtual-link (IPv6 OSPF)	1153
area virtual-link authentication ipsec spi	1155
area virtual-link encryption ipsec spi	1157
auto-cost reference bandwidth (IPv6 OSPF)	1160
bandwidth	1162
clear ipv6 ospf process	1163
debug ipv6 ospf events	1164
debug ipv6 ospf ifsm	1165
debug ipv6 ospf lsa	1166
debug ipv6 ospf nfsm	1167
debug ipv6 ospf packet	1168
debug ipv6 ospf route	1169
default-information originate	1170
default-metric (IPv6 OSPF)	1171
distance (IPv6 OSPF)	1172
ipv6 ospf authentication spi	1174
ipv6 ospf cost	1176
ipv6 ospf dead-interval	1177
ipv6 ospf display route single-line	1178
ipv6 ospf encryption spi esp	1179
ipv6 ospf hello-interval	1182

ipv6 ospf neighbor	1183
ipv6 ospf network	1185
ipv6 ospf priority	1186
ipv6 ospf retransmit-interval	1187
ipv6 ospf transmit-delay	1188
ipv6 router ospf area	1189
max-concurrent-dd (IPv6 OSPF)	1191
passive-interface (IPv6 OSPF)	1192
redistribute (IPv6 OSPF)	1193
restart ipv6 ospf graceful	1195
router ipv6 ospf	1196
router-id (IPv6 OSPF)	1197
show debugging ipv6 ospf	1198
show ipv6 ospf	1199
show ipv6 ospf database	1201
show ipv6 ospf database external	1202
show ipv6 ospf database grace	1203
show ipv6 ospf database inter-prefix	1204
show ipv6 ospf database inter-router	1205
show ipv6 ospf database intra-prefix	1206
show ipv6 ospf database link	1207
show ipv6 ospf database network	1208
show ipv6 ospf database router	1210
show ipv6 ospf interface	1215
show ipv6 ospf neighbor	1216
show ipv6 ospf route	1217
show ipv6 ospf virtual-links	1218
summary-address (IPv6 OSPF)	1219
timers spf exp (IPv6 OSPF)	1221
undebug ipv6 ospf events	1222
undebug ipv6 ospf ifsm	1223
undebug ipv6 ospf lsa	1224
undebug ipv6 ospf nfsm	1225
undebug ipv6 ospf packet	1226
undebug ipv6 ospf route	1227

Chapter 29: BGP and BGP4+ Commands 1228

Introduction	1228
address-family	1234
aggregate-address	1236
auto-summary (BGP only)	1239
bgp aggregate-nexthop-check	1241
bgp always-compare-med	1242
bgp bestpath as-path ignore	1244
bgp bestpath compare-confed-aspath	1245
bgp bestpath compare-routerid	1246
bgp bestpath med	1247
bgp bestpath med remove-recv-med	1249
bgp bestpath med remove-send-med	1250
bgp client-to-client reflection	1251
bgp cluster-id	1252
bgp confederation identifier	1254
bgp confederation peers	1255

bgp config-type	1257
bgp dampening	1259
bgp damp-peer-oscillation (BGP only)	1261
bgp default ipv4-unicast	1262
bgp default local-preference (BGP only)	1263
bgp deterministic-med	1264
bgp enforce-first-as	1266
bgp fast-external-failover	1267
bgp graceful-restart	1268
bgp graceful-restart graceful-reset	1270
bgp log-neighbor-changes	1271
bgp memory maxallocation	1273
bgp nexthop-trigger-count	1274
bgp nexthop-trigger delay	1275
bgp nexthop-trigger enable	1276
bgp rfc1771-path-select (BGP only)	1277
bgp rfc1771-strict (BGP only)	1278
bgp router-id	1279
bgp scan-time (BGP only)	1281
bgp update-delay	1282
clear bgp *	1283
clear bgp (IPv4 or IPv6 address)	1284
clear bgp (ASN)	1286
clear bgp external	1287
clear bgp peer-group	1288
clear bgp ipv6 (ipv6 address) (BGP4+ only)	1289
clear bgp ipv6 dampening (BGP4+ only)	1290
clear bgp ipv6 flap-statistics (BGP4+ only)	1291
clear bgp ipv6 (ASN) (BGP4+ only)	1292
clear bgp ipv6 external (BGP4+ only)	1293
clear bgp ipv6 peer-group (BGP4+ only)	1294
clear ip bgp * (BGP only)	1295
clear ip bgp (IPv4) (BGP only)	1297
clear ip bgp dampening (BGP only)	1299
clear ip bgp flap-statistics (BGP only)	1300
clear ip bgp (ASN) (BGP only)	1301
clear ip bgp external (BGP only)	1302
clear ip bgp peer-group (BGP only)	1303
clear ip prefix-list	1304
debug bgp (BGP only)	1305
distance (BGP and BGP4+)	1307
exit-address-family	1309
ip community-list	1310
ip community-list expanded	1312
ip community-list standard	1314
ip extcommunity-list expanded	1316
ip extcommunity-list standard	1318
ip prefix-list	1320
ipv6 prefix-list	1322
match as-path	1324
match community	1325
max-paths	1327
neighbor activate	1328

neighbor advertisement-interval	1331
neighbor allowas-in	1334
neighbor as-origination-interval	1337
neighbor attribute-unchanged	1339
neighbor capability graceful-restart	1342
neighbor capability orf prefix-list	1345
neighbor capability route-refresh	1348
neighbor collide-established	1351
neighbor default-originate	1354
neighbor description	1357
neighbor disallow-infinite-holdtime	1360
neighbor dont-capability-negotiate	1362
neighbor ebgp-multihop	1365
neighbor enforce-multihop	1368
neighbor filter-list	1371
neighbor interface	1374
neighbor local-as	1376
neighbor maximum-prefix	1379
neighbor next-hop-self	1382
neighbor override-capability	1385
neighbor passive	1387
neighbor password	1390
neighbor peer-group (add a neighbor)	1394
neighbor peer-group (create a peer-group)	1396
neighbor port	1397
neighbor prefix-list	1400
neighbor remote-as	1403
neighbor remove-private-AS (BGP only)	1406
neighbor restart-time	1408
neighbor route-map	1411
neighbor route-reflector-client (BGP only)	1415
neighbor route-server-client (BGP only)	1417
neighbor send-community	1418
neighbor shutdown	1422
neighbor soft-reconfiguration inbound	1424
neighbor timers	1427
neighbor transparent-as	1430
neighbor transparent-nexthop	1432
neighbor unsuppress-map	1434
neighbor update-source	1437
neighbor version (BGP only)	1441
neighbor weight	1443
network (BGP and BGP4+)	1446
network synchronization	1449
redistribute (into BGP or BGP4+)	1450
restart bgp graceful (BGP only)	1452
router bgp	1453
route-map	1454
set as-path	1457
set community	1458
show bgp ipv6 (BGP4+ only)	1460
show bgp ipv6 community (BGP4+ only)	1461
show bgp ipv6 community-list (BGP4+ only)	1463

show bgp ipv6 dampening (BGP4+ only)	1464
show bgp ipv6 filter-list (BGP4+ only)	1465
show bgp ipv6 inconsistent-as (BGP4+ only)	1466
show bgp ipv6 longer-prefixes (BGP4+ only)	1467
show bgp ipv6 neighbors (BGP4+ only)	1468
show bgp ipv6 paths (BGP4+ only)	1471
show bgp ipv6 prefix-list (BGP4+ only)	1472
show bgp ipv6 quote-regexp (BGP4+ only)	1473
show bgp ipv6 regexp (BGP4+ only)	1474
show bgp ipv6 route-map (BGP4+ only)	1476
show bgp ipv6 summary (BGP4+ only)	1477
show bgp memory maxallocation (BGP only)	1478
show bgp nexthop-tracking (BGP only)	1479
show bgp nexthop-tree-details (BGP only)	1480
show debugging bgp (BGP only)	1481
show ip bgp (BGP only)	1482
show ip bgp attribute-info (BGP only)	1483
show ip bgp cidr-only (BGP only)	1484
show ip bgp community (BGP only)	1485
show ip bgp community-info (BGP only)	1487
show ip bgp community-list (BGP only)	1488
show ip bgp dampening (BGP only)	1489
show ip bgp filter-list (BGP only)	1491
show ip bgp inconsistent-as (BGP only)	1492
show ip bgp longer-prefixes (BGP only)	1493
show ip bgp neighbors (BGP only)	1494
show ip bgp neighbors connection-retrytime (BGP only)	1497
show ip bgp neighbors hold-time (BGP only)	1498
show ip bgp neighbors keepalive (BGP only)	1499
show ip bgp neighbors keepalive-interval (BGP only)	1500
show ip bgp neighbors notification (BGP only)	1501
show ip bgp neighbors open (BGP only)	1502
show ip bgp neighbors rcvd-msgs (BGP only)	1503
show ip bgp neighbors sent-msgs (BGP only)	1504
show ip bgp neighbors update (BGP only)	1505
show ip bgp paths (BGP only)	1506
show ip bgp prefix-list (BGP only)	1507
show ip bgp quote-regexp (BGP only)	1508
show ip bgp regexp (BGP only)	1510
show ip bgp route-map (BGP only)	1512
show ip bgp scan (BGP only)	1513
show ip bgp summary (BGP only)	1514
show ip community-list	1516
show ip extcommunity-list	1517
show ip prefix-list	1518
show ipv6 prefix-list	1519
show ip protocols bgp (BGP only)	1520
show route-map	1521
synchronization	1522
timers (BGP)	1524
undebg bgp (BGP only)	1526

Chapter 30: Route Map Commands 1527

Introduction	1527
match as-path	1529
match community	1530
match interface	1532
match ip address	1533
match ip next-hop	1535
match ipv6 address	1537
match ipv6 next-hop	1539
match metric	1540
match origin	1541
match route-type	1543
match tag	1544
route-map	1545
set aggregator	1548
set as-path	1549
set atomic-aggregate	1550
set comm-list delete	1551
set community	1552
set dampening	1554
set extcommunity	1556
set ip next-hop (route map)	1558
set ipv6 next-hop	1559
set local-preference	1560
set metric	1561
set metric-type	1563
set origin	1564
set originator-id	1565
set tag	1566
set weight	1567
show route-map	1568

Chapter 31: Policy-based Routing Commands 1569

Introduction	1569
application-decision	1570
debug policy-based-routing	1572
ip policy-route	1573
ipv6 policy-route	1575
policy-based-routing	1577
policy-based-routing enable	1578
show ip pbr route	1579
show ipv6 pbr route	1581
show pbr rules	1583
show pbr rules brief	1588

Chapter 32: VRF-lite Commands 1590

Introduction	1590
address-family	1593
address-family ipv4 (RIP)	1595
arp	1596
arp opportunistic-nd	1598
clear arp-cache	1600
clear ip bgp * (BGP only)	1602

clear ip bgp (IPv4) (BGP only)	1604
clear ip rip route	1606
crypto key pubkey-chain knownhosts	1608
default-metric (RIP)	1610
description (VRF)	1611
distance (RIP)	1612
distribute-list (RIP)	1613
export map	1614
fullupdate (RIP)	1615
http client vrf	1616
http vrf	1617
fullupdate (RIP)	1618
ip route static inter-vrf	1619
import map	1620
ip route vrf	1621
ip tftp vrf	1624
ip vrf	1625
log host	1626
log host exclude	1628
log host (filter)	1631
log host time	1635
ip vrf forwarding	1637
max-fib-routes (VRF)	1638
max-static-routes (VRF)	1640
neighbor next-hop-self	1641
neighbor remote-as	1644
neighbor password	1647
network (RIP)	1651
passive-interface (RIP)	1653
ping	1654
radius-server host	1656
rd (route distinguisher)	1660
redistribute (into BGP or BGP4+)	1661
redistribute (OSPF)	1663
redistribute (RIP)	1665
route (RIP)	1667
route-target	1668
router ospf	1670
router-id (VRF)	1672
show arp	1673
show crypto key pubkey-chain knownhosts	1675
show ip bgp cidr-only (BGP only)	1677
show ip bgp community (BGP only)	1678
show ip bgp community-list (BGP only)	1680
show ip bgp dampening (BGP only)	1681
show ip bgp filter-list (BGP only)	1683
show ip bgp inconsistent-as (BGP only)	1684
show ip bgp longer-prefixes (BGP only)	1685
show ip bgp prefix-list (BGP only)	1686
show ip bgp quote-regexp (BGP only)	1687
show ip bgp regexp (BGP only)	1689
show ip bgp route-map (BGP only)	1691
show http client	1692

show ip bgp summary (BGP only)	1693
show ip interface vrf	1695
show ip rip vrf database	1697
show ip rip vrf interface	1698
show ip route	1699
show ip route database	1702
show ip route summary	1705
show ip vrf	1707
show ip vrf detail	1708
show ip vrf interface	1709
snmp-server host	1710
show running-config vrf	1713
ssh	1714
ssh client	1716
ssh server vrf	1718
tacacs-server host	1719
tcpdump	1721
telnet	1722
timers (RIP)	1723
traceroute	1725
version (RIP)	1726
vrf	1728

Chapter 33: SD-WAN Commands 1729

Introduction	1729
application-decision	1731
consecutive probe loss	1733
debug linkmon	1735
destination (linkmon-probe)	1737
dscp (linkmon-probe)	1739
egress interface (linkmon-probe)	1740
enable (linkmon-probe)	1741
interval (linkmon-probe)	1742
ip policy-route	1743
ip-version (linkmon-probe)	1745
ipv6 policy-route	1746
jitter	1748
latency	1750
linkmon group	1752
linkmon probe-history	1753
linkmon probe	1755
linkmon profile	1757
load-balancing	1758
member (linkmon-group)	1759
pktloss	1761
preference	1763
sample-size (linkmon-probe)	1765
show debugging linkmon	1766
show linkmon probe	1767
show linkmon probe-history	1770
show pbr rules	1772
show pbr rules brief	1777
size (linkmon-probe)	1779

source (linkmon-probe)	1780
url (linkmon-probe)	1781

PART 4: Multicast Applications 1782

Chapter 34: IGMP and IGMP Snooping Commands 1783

Introduction	1783
clear ip igmp	1785
clear ip igmp group	1786
clear ip igmp interface	1787
debug igmp	1788
ip igmp	1789
ip igmp flood specific-query	1790
ip igmp last-member-query-count	1791
ip igmp last-member-query-interval	1792
ip igmp maximum-groups	1793
ip igmp mroute-proxy	1795
ip igmp proxy-service	1796
ip igmp querier-timeout	1798
ip igmp query-holdtime	1799
ip igmp query-interval	1801
ip igmp query-max-response-time	1803
ip igmp ra-option	1805
ip igmp robustness-variable	1806
ip igmp snooping	1807
ip igmp snooping fast-leave	1808
ip igmp snooping mrouter	1809
ip igmp snooping querier	1810
ip igmp snooping report-suppression	1811
ip igmp snooping routermode	1812
ip igmp snooping source-timeout	1814
ip igmp snooping tcn query solicit	1815
ip igmp source-address-check	1817
ip igmp startup-query-count	1818
ip igmp startup-query-interval	1819
ip igmp trusted	1820
ip igmp version	1821
show debugging igmp	1822
show ip igmp groups	1823
show ip igmp interface	1825
show ip igmp proxy	1827
show ip igmp proxy groups	1828
show ip igmp snooping mrouter	1830
show ip igmp snooping routermode	1831
show ip igmp snooping source-timeout	1832
show ip igmp snooping statistics	1833
undebg igmp	1835

Chapter 35: MLD and MLD Snooping Commands 1836

Introduction	1836
clear ipv6 mld	1838
clear ipv6 mld group	1839

clear ipv6 mld interface	1840
debug mld	1841
ipv6 mld	1842
ipv6 mld last-member-query-count	1843
ipv6 mld last-member-query-interval	1844
ipv6 mld querier-timeout	1845
ipv6 mld query-interval	1846
ipv6 mld query-max-response-time	1847
ipv6 mld robustness-variable	1848
ipv6 mld snooping	1849
ipv6 mld snooping fast-leave	1851
ipv6 mld snooping mrouter	1852
ipv6 mld snooping querier	1854
ipv6 mld snooping report-suppression	1855
ipv6 mld ssm-map enable	1857
ipv6 mld static-group	1858
ipv6 mld version	1860
show debugging mld	1861
show ipv6 mld groups	1862
show ipv6 mld interface	1863
show ipv6 mld snooping mrouter	1864
show ipv6 mld snooping statistics	1865

Chapter 36: Multicast Commands 1866

Introduction	1866
clear ip mroute	1868
clear ip mroute statistics	1869
clear ipv6 mroute	1870
clear ipv6 mroute statistics	1871
debug nsm	1872
debug nsm mcast	1873
debug nsm mcast6	1874
ip mroute	1875
ip multicast handle-igmp-immediately	1877
ip multicast route	1878
ip multicast route-limit	1880
ip multicast wrong-vif-suppression	1881
ip multicast-routing	1882
ipv6 mroute	1883
ipv6 multicast route	1885
ipv6 multicast route-limit	1888
ipv6 multicast-routing	1889
multicast	1890
platform multicast-ratelimit	1891
show debugging nsm mcast	1892
show ip mroute	1893
show ip mvif	1896
show ip rpf	1897
show ipv6 mif	1898
show ipv6 mroute	1899
show ipv6 multicast forwarding	1901

Chapter 37:	PIM-SM Commands	1902
	Introduction	1902
	clear ip pim sparse-mode bsr rp-set *	1904
	clear ip pim sparse-mode packet statistics	1905
	clear ip mroute pim sparse-mode	1906
	debug pim sparse-mode	1907
	debug pim sparse-mode timer	1908
	ip pim anycast-rp	1910
	ip pim bsr-border	1911
	ip pim bsr-candidate	1912
	ip pim cisco-register-checksum	1913
	ip pim crp-cisco-prefix	1914
	ip pim dr-priority	1915
	ip pim exclude-genid	1916
	ip pim ext-srcs-directly-connected	1917
	ip pim hello-holdtime (PIM-SM)	1918
	ip pim hello-interval (PIM-SM)	1919
	ip pim ignore-rp-set-priority	1920
	ip pim jp-timer	1921
	ip pim register-rate-limit	1922
	ip pim register-rp-reachability	1923
	ip pim register-source	1924
	ip pim register-suppression	1925
	ip pim rp-address	1926
	ip pim rp-candidate	1928
	ip pim rp-register-kat	1929
	ip pim sparse-mode	1930
	ip pim sparse-mode join-prune-batching	1931
	ip pim sparse-mode passive	1933
	ip pim sparse-mode wrong-vif-suppression	1934
	ip pim spt-threshold	1936
	ip pim ssm	1937
	service pim	1938
	show debugging pim sparse-mode	1939
	show ip pim sparse-mode bsr-router	1940
	show ip pim sparse-mode interface	1941
	show ip pim sparse-mode interface detail	1943
	show ip pim sparse-mode local-members	1944
	show ip pim sparse-mode mroute	1945
	show ip pim sparse-mode mroute detail	1947
	show ip pim sparse-mode neighbor	1949
	show ip pim sparse-mode nexthop	1951
	show ip pim sparse-mode packet statistics	1952
	show ip pim sparse-mode rp-hash	1953
	show ip pim sparse-mode rp mapping	1954
	undebg all pim sparse-mode	1955
Chapter 38:	PIM-SMv6 Commands	1956
	Introduction	1956
	clear ipv6 mroute pim	1959
	clear ipv6 mroute pim sparse-mode	1960
	clear ipv6 pim sparse-mode bsr rp-set *	1961

debug ipv6 pim sparse-mode	1962
debug ipv6 pim sparse-mode packet	1964
debug ipv6 pim sparse-mode timer	1965
ipv6 pim anycast-rp	1967
ipv6 pim bsr-border	1969
ipv6 pim bsr-candidate	1971
ipv6 pim cisco-register-checksum	1973
ipv6 pim crp-cisco-prefix	1974
ipv6 pim dr-priority	1975
ipv6 pim exclude-genid	1977
ipv6 pim ext-srcs-directly-connected	1978
ipv6 pim hello-holdtime	1979
ipv6 pim hello-interval	1981
ipv6 pim ignore-rp-set-priority	1982
ipv6 pim jp-timer	1983
ipv6 pim neighbor-filter	1984
ipv6 pim register-rate-limit	1985
ipv6 pim register-rp-reachability	1986
ipv6 pim register-source	1987
ipv6 pim register-suppression	1988
ipv6 pim rp-address	1989
ipv6 pim rp-candidate	1991
ipv6 pim rp embedded	1992
ipv6 pim rp-register-kat	1993
ipv6 pim sparse-mode	1994
ipv6 pim sparse-mode passive	1995
ipv6 pim spt-threshold	1996
ipv6 pim ssm	1997
ipv6 pim unicast-bsm	1998
service pim6	1999
show debugging ipv6 pim sparse-mode	2000
show ipv6 pim sparse-mode bsr-router	2001
show ipv6 pim sparse-mode interface	2002
show ipv6 pim sparse-mode interface detail	2004
show ipv6 pim sparse-mode local-members	2005
show ipv6 pim sparse-mode mroute	2006
show ipv6 pim sparse-mode mroute detail	2008
show ipv6 pim sparse-mode neighbor	2010
show ipv6 pim sparse-mode nexthop	2011
show ipv6 pim sparse-mode rp-hash	2012
show ipv6 pim sparse-mode rp mapping	2013
show ipv6 pim sparse-mode rp nexthop	2014
undebg all ipv6 pim sparse-mode	2016
undebg ipv6 pim sparse-mode	2017

PART 5: Access and Security 2019

Chapter 39: Traffic Control Commands 2020

Introduction	2020
class (htb)	2022
class (priority)	2024
class (wrr)	2026

debug traffic-control	2028
interface (traffic-control)	2029
interface dynamic-virtual-bandwidth	2031
l3-filtering enable	2033
move rule (traffic-control)	2034
policy (traffic-control)	2035
red-curve	2037
rule (traffic-control)	2039
show debugging traffic-control	2041
show running-config traffic-control	2042
show traffic-control counters	2044
show traffic-control interface	2046
show traffic-control policy	2048
show traffic-control red-curve	2050
show traffic-control rule config-check	2052
show traffic-control rule	2053
show traffic-control	2054
sub-class (htb)	2055
sub-class (priority)	2057
sub-class (wrr)	2059
sub-sub-class (htb)	2061
sub-sub-class (priority)	2063
sub-sub-class (wrr)	2065
traffic-control enable	2067
traffic-control	2068

Chapter 40: 802.1X Commands 2070

Introduction	2070
dot1x accounting	2072
dot1x authentication	2073
debug dot1x	2074
dot1x control-direction	2075
dot1x eap	2077
dot1x eapol-version	2078
dot1x initialize interface	2079
dot1x initialize supplicant	2080
dot1x keytransmit	2081
dot1x max-auth-fail	2082
dot1x max-reauth-req	2084
dot1x port-control	2086
dot1x timeout tx-period	2088
show debugging dot1x	2089
show dot1x	2090
show dot1x diagnostics	2093
show dot1x interface	2095
show dot1x sessionstatistics	2097
show dot1x statistics interface	2098
show dot1x supplicant	2099
show dot1x supplicant interface	2101
undebug dot1x	2103

Chapter 41: Authentication Commands 2104

Introduction	2104
auth auth-fail vlan	2108
auth critical	2110
auth dhcp-framed-ip-lease	2111
auth dynamic-vlan-creation	2113
auth guest-vlan	2115
auth guest-vlan forward	2117
auth host-mode	2119
auth log	2121
auth max-supplicant	2123
auth max-supplicant tagged-vlan	2125
auth max-supplicant untagged-vlan	2127
auth multi-vlan-session	2129
auth priority	2130
auth profile (global)	2132
auth profile (interface)	2133
auth reauthentication	2134
auth roaming disconnected	2135
auth roaming enable	2137
auth supplicant-ip	2139
auth supplicant-mac	2141
auth timeout connect-timeout	2144
auth timeout quiet-period	2146
auth timeout reauth-period	2147
auth timeout server-timeout	2149
auth timeout supp-timeout	2151
auth vlan-restriction	2152
auth two-step enable	2154
auth two-step order	2156
auth-mac accounting	2158
auth-mac authentication	2159
auth-mac enable	2160
auth-mac method	2162
auth-mac password	2164
auth-mac reauth-relearning	2165
auth-mac static	2166
auth-mac username	2167
auth-web accounting	2168
auth-web authentication	2169
auth-web enable	2170
auth-web forward	2172
auth-web idle-timeout enable	2175
auth-web idle-timeout timeout	2176
auth-web max-auth-fail	2177
auth-web method	2179
auth-web-server dhcp ipaddress	2180
auth-web-server dhcp lease	2182
auth-web-server dhcp-wpad-option	2183
auth-web-server host-name	2184
auth-web-server intercept-port	2185
auth-web-server ip-conflict-prefer-newer-supplicant	2186
auth-web-server ipaddress	2187
auth-web-server page language	2188

auth-web-server login-url	2189
auth-web-server page logo	2190
auth-web-server page sub-title	2191
auth-web-server page success-message	2192
auth-web-server page title	2193
auth-web-server page welcome-message	2194
auth-web-server ping-poll enable	2195
auth-web-server ping-poll failcount	2196
auth-web-server ping-poll interval	2197
auth-web-server ping-poll reauth-timer-refresh	2198
auth-web-server ping-poll timeout	2199
auth-web-server ping-poll type	2200
auth-web-server port	2202
auth-web-server redirect-delay-time	2203
auth-web-server redirect-url	2204
auth-web-server session-keep	2205
auth-web-server ssl	2206
auth-web-server ssl intercept-port	2207
auth-web-server trustpoint	2208
copy proxy-autoconfig-file	2210
copy web-auth-https-file	2211
description (auth-profile)	2212
erase proxy-autoconfig-file	2213
erase web-auth-https-file	2214
show auth	2215
show auth diagnostics	2216
show auth interface	2217
show auth sessionstatistics	2219
show auth statistics interface	2220
show auth supplicant	2221
show auth supplicant interface	2224
show auth two-step supplicant brief	2225
show auth-web-server	2227
show auth-web-server page	2228
show proxy-autoconfig-file	2229

Chapter 42: AAA Commands 2230

Introduction	2230
aaa accounting auth-mac	2232
aaa accounting auth-web	2234
aaa accounting commands	2236
aaa accounting dot1x	2238
aaa accounting login	2240
aaa accounting update	2243
aaa authentication auth-mac	2245
aaa authentication auth-web	2247
aaa authentication dot1x	2249
aaa authentication enable default group tacacs+	2251
aaa authentication enable default local	2253
aaa authentication isakmp	2254
aaa authentication login	2255
aaa authentication openvpn	2258
aaa authorization commands	2260

aaa authorization config-commands	2262
aaa group server	2263
aaa local authentication attempts lockout-time	2265
aaa local authentication attempts max-fail	2266
aaa login fail-delay	2267
accounting login	2268
authorization commands	2269
clear aaa local user lockout	2271
debug aaa	2272
login authentication	2273
proxy-port	2274
radius-secure-proxy aaa	2275
server (radseproxy-aaa)	2276
server mutual-authentication	2278
server name-check	2279
server trustpoint	2280
show aaa local user locked	2282
show aaa server group	2283
show debugging aaa	2284
show radius server group	2285
undebug aaa	2287

Chapter 43: Lightweight Directory Access Protocol (LDAP) Commands 2288

Introduction	2288
authentication (ldap-server)	2290
base-dn	2292
bind authenticate root-dn	2293
deadtime (ldap-server)	2294
debug ldap client	2295
group-attribute	2297
group-dn	2298
host (ldap-server)	2299
ldap-server	2301
login-attribute	2303
port (ldap-server)	2305
retransmit (ldap-server)	2306
search-filter	2307
secure cipher (ldap-server)	2309
secure mode (ldap-server)	2311
secure trustpoint (ldap-server)	2313
server (ldap-group)	2314
show ldap server group	2315
timeout (ldap-server)	2317

Chapter 44: RADIUS Commands 2318

Introduction	2318
clear radius dynamic-authorization counters	2319
deadtime (RADIUS server group)	2320
debug radius	2321
ip radius source-interface	2322
radius dynamic-authorization-client	2323
radius-server deadtime	2324

radius-server host	2325
radius-server key	2329
radius-server retransmit	2330
radius-server timeout	2332
server (RADIUS server group)	2334
show debugging radius	2336
show radius	2337
show radius dynamic-authorization counters	2340
undebg radius	2342

Chapter 45: Local RADIUS Server Commands 2343

Introduction	2343
attribute (radsrv-grp)	2345
authentication	2347
client (radsecproxy-srv)	2348
client mutual-authentication	2350
client name-check	2351
client trustpoint	2352
clear radius local-server statistics	2353
copy fdb-radius-users (to file)	2354
copy local-radius-user-db (from file)	2356
copy local-radius-user-db (to file)	2357
crypto pki enroll local (deleted)	2358
crypto pki enroll local local-radius-all-users (deleted)	2359
crypto pki enroll local user (deleted)	2360
crypto pki export local pem (deleted)	2361
crypto pki export local pkcs12 (deleted)	2362
crypto pki trustpoint local (deleted)	2363
debug crypto pki (deleted)	2364
domain-style	2365
egress-vlan-id (radsrv-grp)	2366
egress-vlan-name (radsrv-grp)	2367
group (radsrv)	2368
nas	2369
help radius-attribute	2370
radius-secure-proxy local-server	2372
radius-server local	2373
server auth-port	2374
server enable	2375
show radius local-server group	2376
show radius local-server nas	2377
show radius local-server statistics	2378
show radius local-server user	2379
user (radsrv)	2381
vlan (radsrv-grp)	2383

Chapter 46: Two-factor Authentication (2FA) Commands 2384

Introduction	2384
2fa allow-reuse	2386
2fa create user	2387
2fa delete user	2389
2fa hotp-window-size	2390

	2fa issuer	2391
	2fa label	2393
	2fa max-skew	2395
	2fa reject-unconfigured-users	2396
	2fa reset scratch-codes	2397
	2fa reset skew	2398
	2fa skew adjust	2399
	2fa totp-window-size	2401
	debug 2fa	2402
	service 2fa	2403
	show 2fa	2405
	show 2fa user	2406
	show 2fa users	2408
	show debugging 2fa	2409
Chapter 47:	Public Key Infrastructure and Crypto Commands	2410
	Introduction	2410
	crypto key generate rsa	2411
	crypto key zeroize	2412
	crypto pki authenticate	2413
	crypto pki enroll	2414
	crypto pki enroll user	2415
	crypto pki export pem	2417
	crypto pki export pkcs12	2418
	crypto pki import pem	2420
	crypto pki import pkcs12	2422
	crypto pki trustpoint	2423
	enrollment (ca-trustpoint)	2424
	fingerprint (ca-trustpoint)	2425
	no crypto pki certificate	2427
	rsakeypair (ca-trustpoint)	2428
	show crypto key mypubkey rsa	2429
	show crypto pki certificates	2430
	show crypto pki enrollment user	2432
	show crypto pki trustpoint	2433
	subject-name (ca-trustpoint)	2434
Chapter 48:	TACACS+ Commands	2436
	Introduction	2436
	aaa authorization commands	2437
	aaa authorization config-commands	2439
	authorization commands	2440
	ip tacacs source-interface	2442
	show tacacs+	2443
	tacacs-server host	2445
	tacacs-server key	2447
	tacacs-server timeout	2448
PART 6:	High Availability	2449
Chapter 49:	High Availability Commands	2450
	Introduction	2450

	ha associate	2451
	wan-bypass (interface mode)	2453
Chapter 50:	VRRP Commands	2454
	Introduction	2454
	advertisement-interval	2456
	alternate-checksum-mode	2458
	circuit-failover	2459
	debug vrrp	2461
	debug vrrp events	2462
	debug vrrp packet	2463
	disable (VRRP)	2464
	enable (VRRP)	2465
	preempt-mode	2466
	priority	2468
	router ipv6 vrrp (interface)	2470
	router vrrp (interface)	2472
	show debugging vrrp	2474
	show running-config router ipv6 vrrp	2475
	show running-config router vrrp	2476
	show vrrp	2477
	show vrrp counters	2479
	show vrrp ipv6	2482
	show vrrp (session)	2483
	transition-mode	2485
	undebg vrrp	2487
	undebg vrrp events	2488
	undebg vrrp packet	2489
	virtual-ip	2490
	virtual-ipv6	2492
	vrrp vmac	2494
PART 7:	Network Management	2495
Chapter 51:	Allied Telesis Management Framework™ (AMF) Commands	2496
	Introduction	2496
	application-proxy ip-filter	2502
	application-proxy quarantine-vlan	2503
	application-proxy redirect-url	2504
	application-proxy threat-protection	2505
	application-proxy threat-protection send-summary	2506
	application-proxy whitelist advertised-address	2507
	application-proxy whitelist enable	2508
	application-proxy whitelist protection tls	2509
	application-proxy whitelist server	2510
	application-proxy whitelist trustpoint (deprecated)	2512
	area-link	2513
	atmf-arealink	2515
	atmf-link	2517
	atmf area	2518
	atmf area password	2520
	atmf authorize	2522

atmf authorize provision	2524
atmf backup	2526
atmf backup area-masters delete	2527
atmf backup area-masters enable	2528
atmf backup area-masters now	2529
atmf backup area-masters synchronize	2530
atmf backup bandwidth	2531
atmf backup delete	2532
atmf backup enable	2533
atmf backup guests delete	2534
atmf backup guests enable	2535
atmf backup guests now	2536
atmf backup guests synchronize	2537
atmf backup now	2538
atmf backup redundancy enable	2540
atmf backup server	2541
atmf backup stop	2543
atmf backup synchronize	2544
atmf cleanup	2545
atmf container	2546
atmf container login	2547
atmf controller	2548
atmf distribute firmware	2549
atmf domain vlan	2551
atmf enable	2554
atmf group (membership)	2555
atmf guest-class	2557
atmf log-verbose	2559
atmf management subnet	2560
atmf management vlan	2563
atmf master	2565
atmf mtu	2566
atmf network-name	2567
atmf provision (interface)	2568
atmf provision node	2569
atmf reboot-rolling	2571
atmf recover	2575
atmf recover guest	2577
atmf recover led-off	2578
atmf recover over-eth	2579
atmf recovery-server	2580
atmf remote-login	2582
atmf restricted-login	2584
atmf retry guest-link	2586
atmf secure-mode	2587
atmf secure-mode certificate expire	2589
atmf secure-mode certificate expiry	2590
atmf secure-mode certificate renew	2591
atmf secure-mode enable-all	2592
atmf select-area	2594
atmf topology-gui enable	2595
atmf trustpoint	2596
atmf virtual-crosslink	2598

atmf virtual-link	2600
atmf virtual-link description	2603
atmf virtual-link protection	2604
atmf working-set	2606
bridge-group (amf-container)	2608
clear application-proxy threat-protection	2610
clear atmf links	2611
clear atmf links virtual	2612
clear atmf links statistics	2613
clear atmf recovery-file	2614
clear atmf secure-mode certificates	2615
clear atmf secure-mode statistics	2616
clone (amf-provision)	2617
configure boot config (amf-provision)	2619
configure boot system (amf-provision)	2621
copy (amf-provision)	2623
create (amf-provision)	2624
debug atmf	2626
debug atmf packet	2628
delete (amf-provision)	2631
discovery	2633
description (amf-container)	2635
erase factory-default	2636
http-enable	2637
identity (amf-provision)	2639
license-cert (amf-provision)	2641
locate (amf-provision)	2643
log event-host	2645
login-fallback enable	2646
modeltype	2647
service atmf-application-proxy	2648
show application-proxy threat-protection	2649
show application-proxy whitelist advertised-address	2651
show application-proxy whitelist interface	2652
show application-proxy whitelist server	2654
show application-proxy whitelist supplicant	2655
show atmf	2657
show atmf area	2661
show atmf area guests	2664
show atmf area guests-detail	2666
show atmf area nodes	2668
show atmf area nodes-detail	2670
show atmf area summary	2672
show atmf authorization	2673
show atmf backup	2676
show atmf backup area	2680
show atmf backup guest	2682
show atmf container	2684
show atmf detail	2687
show atmf group	2689
show atmf group members	2691
show atmf guests	2693
show atmf guests detail	2695

show atmf links	2698
show atmf links detail	2700
show atmf links guest	2709
show atmf links guest detail	2711
show atmf links statistics	2715
show atmf nodes	2718
show atmf provision nodes	2720
show atmf recovery-file	2722
show atmf secure-mode	2723
show atmf secure-mode audit	2725
show atmf secure-mode audit link	2726
show atmf secure-mode certificates	2727
show atmf secure-mode sa	2730
show atmf secure-mode statistics	2733
show atmf tech	2735
show atmf virtual-links	2738
show atmf working-set	2740
show debugging atmf	2741
show debugging atmf packet	2742
show running-config atmf	2743
state	2744
switchport atmf-agentlink	2746
switchport atmf-arealink	2747
switchport atmf-crosslink	2749
switchport atmf-guestlink	2751
switchport atmf-link	2753
type atmf guest	2754
type atmf node	2755
undebbug atmf	2757
username (atmf-guest)	2758

Chapter 52: Autonomous Wave Control Commands 2759

Introduction	2759
3gpp-info (wireless-network-passpoint-dot11u)	2767
additional-step-required enable (wireless-network-passpoint-dot11u)	2768
airtime-fairness enable (wireless-ap-prof-radio)	2769
anqp-domain-id (wireless-network-passpoint-hs20)	2771
anqp-element (wireless-network-passpoint-dot11u)	2772
antenna (wireless-ap-prof-radio)	2773
ap	2774
ap-profile (wireless)	2775
ap-profile (wireless-ap)	2776
association-advertisement enable	2777
authentication (wireless-sec-wep)	2778
auto-discovery disable	2779
band	2780
band-steering (wireless-network)	2781
bandwidth (wireless-ap-prof-radio)	2782
bcst-key-refresh-interval (wireless-sec-osen)	2783
bcst-key-refresh-interval (wireless-sec-wpa-ent)	2784
bcst-key-refresh-interval (wireless-sec-wpa-psnl)	2785
captive-portal	2786
bss-trans-manage enable	2787

captive-portal virtual-ip	2788
channels (wireless-ap-prof-radio)	2789
channel (wireless-ap-radio)	2790
ciphers (wireless-sec-osen)	2791
ciphers (wireless-sec-wpa-ent)	2792
ciphers (wireless-sec-wpa-psnl)	2793
community read-only (wireless-ap-prof-snmp)	2794
community trap (wireless-ap-prof-snmp)	2796
conn-capability protocol (wireless-network-passpoint-hs20)	2797
country-code	2799
day (wireless-task)	2800
death-req-timeout (wireless-network-passpoint-hs20)	2801
debug wireless	2802
description (wireless-ap)	2804
description (wireless-ap-prof)	2805
description (wireless-mac-flt)	2806
description (wireless-network)	2807
description (wireless-sc-prof)	2808
description (wireless-task)	2809
description (wireless-trigger)	2810
dgaf enable (wireless-network-passpoint-hs20)	2811
domain-name (wireless-network-passpoint-dot11u)	2812
dot11u (wireless-network-passpoint)	2813
dtim-period	2814
dup-auth-received (wireless-network)	2815
dynamic-vlan enable (wireless-sec-osen)	2816
enable (wireless-ap-prof-snmp)	2817
emergency-mode	2818
emergency-mode usb enable	2819
emergency-mode usb key	2820
emergency-service-reachable enable (wireless-network-passpoint-dot11u)	2822
enable (wireless)	2823
enable (wireless-ap)	2824
enable (wireless-ap-prof-radio)	2825
enable (wireless-network-cp)	2826
enable (wireless-network-passpoint)	2827
enable (wireless-sec-wep)	2828
enable (wireless-task)	2829
enable (wireless-wds)	2830
external-page-url	2831
filter-entry	2832
force-disable (wireless-ap-radio)	2834
gas-address-behavior (wireless-network-passpoint-dot11u)	2835
gas-comeback-delay (wireless-network-passpoint-dot11u)	2836
hessid (wireless-network-passpoint-dot11u)	2837
hide-ssid (wireless-network)	2838
hs20 (wireless-network-passpoint)	2839
hwtype	2840
index	2842
initialization-button enable	2843
internet-access enable (wireless-network-passpoint-dot11u)	2844
ip-addr-type-availability (wireless-network-passpoint-dot11u)	2845

ip-address (wireless-ap)	2847
key (wireless-sc-prof)	2848
key (wireless-sec-wep)	2849
key (wireless-sec-wpa-psnl)	2851
l2tif enable (wireless-network-passpoint-hs20)	2852
led enable	2853
legacy-rates	2854
length (wireless-sec-wep)	2855
log enable destination	2856
log interval neighbor-ap	2857
log rotate neighbor-ap	2858
log rotate wireless-client	2859
log size wireless-client	2860
login username (wireless-ap)	2861
login-password (wireless-ap)	2862
mac-address (wireless-ap)	2863
mac-auth password	2864
mac-auth radius auth group (wireless-network)	2865
mac-auth username	2866
management address	2868
management-frame-protection enable (wireless-sec-osen)	2869
management-frame-protection enable (wireless-sec-wpa-ent)	2871
management-frame-protection enable (wireless-sec-wpa-psnl)	2873
max-clients	2875
mode (wireless-ap-prof-radio)	2876
mode (wireless-network-cp)	2878
nai-realm (wireless-network-passpoint-dot11u)	2880
neighbor-ap-detection enable	2882
neighbor-managed-ap-detection enable	2883
network-auth-type (wireless-network-passpoint-dot11u)	2884
network-type (wireless-network-passpoint-dot11u)	2886
network (wireless)	2888
ntp designated-server	2889
ntp designated-server enable	2890
ntp designated-server period	2891
operating-class (wireless-network-passpoint-hs20)	2892
operator (wireless-network-passpoint-hs20)	2893
osu-providers friendly-name lang name	2894
osu-providers icon lang file	2896
osu-providers method-list	2898
osu-providers nai	2900
osu-providers server-uri	2902
osu-providers service-desc lang desc	2903
osu ssid	2905
osu status enable	2907
outdoor	2908
page-proxy-url	2909
passpoint	2910
peer (wireless-wds)	2911
permit host (wireless-ap-prof-snmp)	2912
port (wireless-ap-prof-snmp)	2913
power (wireless-ap-radio)	2914
pre-authentication enable (wireless-sec-osen)	2915

pre-authentication enable (wireless-sec-wpa-ent)	2916
proxy-arp enable	2917
qos-map-set (wireless-network-passpoint-dot11u)	2918
radio (wireless-ap)	2919
radio (wireless-ap-profile)	2920
radius accounting enable	2921
radius auth group (wireless-network-cp)	2922
radius authentication group (wireless-sec-osen)	2924
radius auth group (wireless-sec-wpa-ent)	2925
redirect-url	2926
rogue-ap-detection enable (wireless)	2928
roaming-oi (wireless-network-passpoint-dot11u)	2929
sc-profile	2930
sc-channel	2931
security (wireless)	2932
security (wireless-network)	2934
security (wireless-wds)	2935
service wireless	2936
session-keep	2937
session-key-refresh-action	2938
session-key-refresh-interval	2939
session-timeout-action (wireless network-cp)	2940
session-timeout-interval (wireless network-cp)	2941
show debugging wireless	2942
show wireless	2943
show wireless ap	2944
show wireless ap capability	2951
show wireless ap client	2953
show wireless ap neighbors	2954
show wireless ap power-channel	2955
show wireless ap-profile	2956
show wireless auto-config	2960
show wireless captive-portal network walled-garden	2963
show wireless country-code	2964
show wireless network	2965
show wireless power-channel calculate	2970
show wireless sc-profile	2971
show wireless security	2973
show wireless smart-connect ap	2975
show wireless task	2976
show wireless wds	2979
show wireless wireless-mac-filter	2981
show wireless wireless-trigger	2983
smart-connect-profile	2984
snmp (wireless-ap-prof)	2985
ssid (wireless-network)	2986
ssid (wireless-sc-prof)	2987
station-isolation enable (wireless-ap-prof-radio)	2988
task	2989
time (wireless-task)	2990
trap host (wireless-ap-prof-snmp)	2991
type (wireless-sec-wep)	2992
type ap-configuration apply ap	2993

type download ap (wireless-task)	2994
type power-channel ap all	2995
unauth-emergency-service-access enable (wireless-network-passpoint-dot11u)	2996
username (wireless-ap-prof-snmp)	2997
vap (wireless-ap-prof-radio)	2999
venue group (wireless-network-passpoint-dot11u)	3000
venue name (wireless-network-passpoint-dot11u)	3001
venue type (wireless-network-passpoint-dot11u)	3002
version (wireless-ap-prof-snmp)	3003
versions (wireless-sec-osen)	3004
versions (wireless-sec-wpa-ent)	3005
versions (wireless-sec-wpa-psnl)	3006
vlan (wireless-network)	3007
walled-garden entry	3008
wan-metrics downlink-load (wireless-network-passpoint-hs20)	3010
wan-metrics downlink-speed (wireless-network-passpoint-hs20)	3011
wan-metrics info (wireless-network-passpoint-hs20)	3012
wan-metrics load-measure-duration (wireless-network-passpoint-hs20)	3014
wan-metrics uplink-load (wireless-network-passpoint-hs20)	3015
wan-metrics uplink-speed (wireless-network-passpoint-hs20)	3016
wds	3017
wds radio (wireless-ap)	3018
web-auth radius auth group	3019
wireless	3020
wireless ap-configuration apply ap	3021
wireless auto-config	3022
wireless download ap url	3024
wireless emergency-mode	3026
wireless emergency-mode usb mark key	3027
wireless export	3029
wireless get-tech abort	3030
wireless get-tech ap	3031
wireless get-tech ap-profile	3032
wireless get-tech sc-profile	3033
wireless import	3034
wireless power-channel ap all	3035
wireless reset ap	3036
wireless-mac-filter (wireless)	3037
wireless-mac-filter (wireless-ap-prof)	3038
wireless-mac-filter enable	3040
wireless wireless-trigger	3041
wireless-trigger	3042
wireless-trigger-id	3043

Chapter 53:	Device Discovery using SNMP Commands	3044
	Introduction	3044
	clear snmp-discovery	3045
	service snmp-discovery	3046
	show running-config snmp-discovery	3047
	show snmp-discovery	3048
	snmp-discovery arp-polling-interval	3051
	snmp-discovery community	3052

snmp-discovery deny	3053
snmp-discovery permit	3055
snmp-discovery snmp-polling-interval	3056
snmp-discovery snmp-version	3057
snmp-discovery user	3058

Chapter 54: Dynamic Host Configuration Protocol (DHCP) Commands 3060

Introduction	3060
bootfile	3062
clear ip dhcp binding	3063
default-router	3065
dns-server	3066
domain-name	3067
host (DHCP)	3068
ip address dhcp	3069
ip dhcp bootp ignore	3071
ip dhcp leasequery enable	3072
ip dhcp option	3073
ip dhcp pool	3075
ip dhcp-client default-route distance	3076
ip dhcp-client request vendor-identifying-specific	3078
ip dhcp-client vendor-identifying-class	3079
ip dhcp-relay agent-option	3080
ip dhcp-relay agent-option checking	3082
ip dhcp-relay agent-option remote-id	3083
ip dhcp-relay information policy	3084
ip dhcp-relay maxhops	3086
ip dhcp-relay max-message-length	3087
ip dhcp-relay server-address	3089
ip dhcp-relay use-client-side-address	3091
lease	3092
network (DHCP)	3094
next-server	3095
option	3096
probe enable	3098
probe packets	3099
probe timeout	3100
probe type	3101
range	3102
route	3103
service dhcp-relay	3104
service dhcp-server	3105
short-lease-threshold	3106
show counter dhcp-client	3108
show counter dhcp-relay	3109
show counter dhcp-server	3113
show dhcp lease	3116
show ip dhcp binding	3117
show ip dhcp pool	3119
show ip dhcp-relay	3124
show ip dhcp server statistics	3126
show ip dhcp server summary	3129
subnet-mask	3130

vrf	3131
---------------	------

Chapter 55: DHCP for IPv6 (DHCPv6) Commands 3132

Introduction	3132
address prefix	3134
address range	3136
clear counter ipv6 dhcp-client	3138
clear counter ipv6 dhcp-server	3139
clear ipv6 dhcp binding	3140
clear ipv6 dhcp client	3142
dns-server (DHCPv6)	3143
domain-name (DHCPv6)	3145
ip dhcp-relay agent-option	3146
ip dhcp-relay agent-option checking	3148
ip dhcp-relay agent-option remote-id	3149
ip dhcp-relay information policy	3150
ip dhcp-relay maxhops	3152
ip dhcp-relay max-message-length	3153
ip dhcp-relay server-address	3155
ipv6 address (DHCPv6 PD)	3157
ipv6 address dhcp	3159
ipv6 dhcp client pd	3161
ipv6 dhcp option	3163
ipv6 dhcp pool	3165
ipv6 dhcp server	3167
ipv6 local pool	3169
ipv6 nd prefix (DHCPv6)	3171
link-address	3173
option (DHCPv6)	3175
prefix-delegation pool	3177
service dhcp-relay	3179
show counter dhcp-relay	3180
show counter ipv6 dhcp-client	3184
show counter ipv6 dhcp-server	3186
show ip dhcp-relay	3188
show ipv6 dhcp	3190
show ipv6 dhcp binding	3191
show ipv6 dhcp interface	3194
show ipv6 dhcp pool	3196
sntp-address	3198

Chapter 56: NTP Commands 3199

Introduction	3199
ntp authentication-key	3200
ntp broadcastdelay	3201
ntp master	3202
ntp peer	3203
ntp rate-limit	3205
ntp restrict	3206
ntp server	3208
ntp source	3210
show ntp associations	3212

show ntp counters	3214
show ntp counters associations	3215
show ntp status	3216

Chapter 57: SNMP Commands 3217

Introduction	3217
alias (interface)	3219
debug snmp	3220
show counter snmp-server	3221
show debugging snmp	3225
show running-config snmp	3226
show snmp-server	3227
show snmp-server community	3228
show snmp-server group	3229
show snmp-server trap	3230
show snmp-server user	3231
show snmp-server view	3232
snmp trap link-status	3233
snmp trap link-status suppress	3235
snmp-server	3237
snmp-server community	3239
snmp-server contact	3240
snmp-server enable trap	3241
snmp-server engineID local	3244
snmp-server engineID local reset	3246
snmp-server group	3247
snmp-server host	3249
snmp-server legacy-ifadminstatus	3252
snmp-server location	3253
snmp-server source-interface	3254
snmp-server startup-trap-delay	3255
snmp-server user	3256
snmp-server view	3259
undebug snmp	3260

Chapter 58: LLDP Commands 3261

Introduction	3261
clear lldp statistics	3263
clear lldp table	3264
debug lldp	3265
lldp faststart-count	3266
lldp holdtime-multiplier	3267
lldp management-address	3268
lldp med-notifications	3269
lldp med-tlv-select	3270
lldp non-strict-med-tlv-order-check	3273
lldp notification-interval	3274
lldp notifications	3275
lldp port-number-type	3276
lldp reinit	3277
lldp run	3278
lldp timer	3279

	lldp tlv-select	3280
	lldp transmit receive	3282
	lldp tx-delay	3283
	location civic-location configuration	3284
	location civic-location identifier	3288
	location civic-location-id	3289
	location coord-location configuration	3290
	location coord-location identifier	3292
	location coord-location-id	3293
	location elin-location	3295
	location elin-location-id	3296
	show debugging lldp	3297
	show lldp	3298
	show lldp interface	3300
	show lldp local-info	3302
	show lldp neighbors	3307
	show lldp neighbors detail	3308
	show lldp statistics	3312
	show lldp statistics interface	3314
	show location	3316
Chapter 59:	Mail (SMTP) Commands	3318
	Introduction	3318
	debug mail	3319
	delete mail	3320
	mail	3321
	mail from	3323
	mail smtpserver	3324
	mail smtpserver authentication	3325
	mail smtpserver port	3327
	show counter mail	3329
	show mail	3330
	undebug mail	3331
Chapter 60:	RMON Commands	3332
	Introduction	3332
	rmon alarm	3333
	rmon collection history	3336
	rmon collection stats	3337
	rmon event	3338
	show rmon alarm	3339
	show rmon event	3340
	show rmon history	3342
	show rmon statistics	3344
Chapter 61:	Secure Shell (SSH) Commands	3346
	Introduction	3346
	banner login (SSH)	3348
	clear ssh	3349
	crypto key destroy hostkey	3350
	crypto key destroy userkey	3351
	crypto key generate hostkey	3352

crypto key generate userkey	3354
crypto key pubkey-chain knownhosts	3355
crypto key pubkey-chain userkey	3357
debug ssh client	3359
debug ssh server	3360
service ssh	3361
show banner login	3363
show crypto key hostkey	3364
show crypto key pubkey-chain knownhosts	3366
show crypto key pubkey-chain userkey	3368
show crypto key userkey	3369
show running-config ssh	3370
show ssh	3372
show ssh client	3374
show ssh server	3375
show ssh server allow-users	3377
show ssh server deny-users	3378
ssh	3379
ssh client	3381
ssh server	3383
ssh server vrf	3385
ssh server allow-users	3386
ssh server authentication	3388
ssh server deny-users	3390
ssh server max-auth-tries	3392
ssh server resolve-host	3393
ssh server scp	3394
ssh server secure-algs	3395
ssh server secure-ciphers	3396
ssh server secure-kex	3397
ssh server secure-mac	3398
ssh server sftp	3399
ssh server tcpforwarding	3400
undebug ssh client	3401
undebug ssh server	3402

Chapter 62: Trigger Commands 3403

Introduction	3403
active (trigger)	3405
day	3406
debug trigger	3408
description (trigger)	3409
repeat	3410
script	3411
show debugging trigger	3413
show running-config trigger	3414
show trigger	3415
test	3420
time (trigger)	3421
trap	3423
trigger	3424
trigger activate	3425
type atmf guest	3426

type atmf node	3427
type cpu	3429
type env-sensor	3430
type interface	3432
type linkmon-probe	3433
type log	3435
type memory	3436
type periodic	3437
type ping-poll	3438
type reboot	3439
type time	3440
type usb	3441
undebug trigger	3442

Chapter 63: Ping-Polling Commands 3443

Introduction	3443
active (ping-polling)	3445
clear ping-poll	3446
critical-interval	3447
debug ping-poll	3448
description (ping-polling)	3449
fail-count	3450
ip (ping-polling)	3451
length (ping-poll data)	3452
normal-interval	3453
ping-poll	3454
sample-size	3455
show counter ping-poll	3457
show ping-poll	3459
source-ip	3463
timeout (ping polling)	3465
up-count	3466
undebug ping-poll	3467

PART 8: Firewall and Network Address Translation (NAT) 3468

Chapter 64: Firewall Commands 3469

Introduction	3469
clear firewall connections	3471
connection-limit (firewall)	3472
connection-log events	3474
firewall	3475
debug firewall	3476
ip tcp timeout established	3477
move rule (firewall)	3478
protect (firewall)	3479
rule (firewall)	3480
show connection-log events	3483
show firewall	3484
show firewall connections	3485
show firewall connections limits	3486
show firewall connections limits config-check	3487

	show firewall rule	3488
	show firewall rule config-check	3490
	show debugging firewall	3491
	show running-config firewall	3492
Chapter 65:	Application and Entity Commands	3493
	Introduction	3493
	application	3495
	dport	3497
	dscp	3499
	host (network)	3501
	icmp-code	3503
	icmp-type	3505
	ip address (host)	3507
	ip subnet	3509
	ipv6 address (host)	3511
	ipv6 subnet	3513
	network (zone)	3515
	protocol	3517
	show application	3518
	show application detail	3519
	show entity	3521
	sport	3524
	zone	3526
Chapter 66:	NAT Commands	3528
	Introduction	3528
	enable (nat)	3530
	ip limited-local-proxy-arp	3531
	local-proxy-arp	3533
	move rule (nat)	3534
	nat	3535
	rule (nat)	3536
	show nat	3540
	show nat rule	3541
	show nat rule config-check	3543
	show running-config nat	3544
PART 9:	Advanced Network Protection	3545
Chapter 67:	IPS Commands	3546
	Introduction	3546
	alert-thresholding	3547
	category action (IPS)	3548
	ips	3549
	protect (IPS)	3550
	show ips	3551
	show ips categories	3552
	show running-config ips	3554
Chapter 68:	URL Filtering Commands	3555

	Introduction	3555
	blacklist	3557
	log url-requests	3558
	protect (url-filter)	3559
	show running-config url-filter	3560
	show url-filter	3561
	url-filter reload custom-lists	3562
	url-filter	3563
	whitelist (url-filter)	3564
Chapter 69:	Application Awareness Commands	3565
	Introduction	3565
	counters detailed	3566
	dpi	3567
	enable (dpi)	3568
	hostname (application)	3570
	provider (dpi)	3571
	show dpi	3572
	show dpi statistics	3573
	show running-config dpi	3575
	web-categorization	3576
Chapter 70:	URL Offload Commands	3578
	Introduction	3578
	endpoint-source	3580
	entry (endpoint-manual)	3582
	exclude-entry (endpoint-manual)	3584
	exclude-entry (endpoint-office365)	3586
	filter-endpoint	3588
	filter-endpoint include all	3591
	filter-entry exclude	3593
	filter-entry exclude type	3595
	pac-file http-server port	3597
	pac-file proxy-address	3599
	pac-file template	3600
	parser-updates enable	3602
	parser-updates interval	3603
	service url-offload	3604
	show running-config url-offload	3605
	show url-offload endpoint-source	3606
	show url-offload endpoint-source manual entries	3607
	show url-offload endpoint-source office365 entries	3609
	show url-offload endpoint-source office365 raw-data	3612
	show url-offload pac-file	3615
	show url-offload pac-file template	3619
	update-interval (endpoint-office365)	3621
	url (endpoint office365)	3622
	url-offload	3623
	url-offload update-now	3624
PART 10:	Virtual Private Networks (VPNs)	3625

Chapter 71:	IPsec Commands	3626
	Introduction	3626
	clear isakmp sa	3628
	crypto ipsec profile	3629
	crypto isakmp key	3631
	crypto isakmp peer	3634
	crypto isakmp profile	3636
	debug isakmp	3638
	dpd-interval	3640
	dpd-timeout	3641
	interface tunnel (IPsec)	3642
	lifetime (IPsec Profile)	3643
	lifetime (ISAKMP Profile)	3644
	no debug isakmp	3645
	pfs	3646
	rekey	3648
	show debugging isakmp	3649
	show interface tunnel (IPsec)	3650
	show ipsec counters	3652
	show ipsec peer	3653
	show ipsec policy	3654
	show ipsec profile	3655
	show ipsec sa	3657
	show isakmp counters	3658
	show isakmp key (IPsec)	3659
	show isakmp peer	3660
	show isakmp profile	3661
	show isakmp sa	3663
	show tunnel inline-processing counters	3664
	transform (IPsec Profile)	3666
	transform (ISAKMP Profile)	3667
	tunnel destination (IPsec)	3669
	tunnel inline-processing	3671
	tunnel local name (IPsec)	3672
	tunnel local selector	3673
	tunnel mode ipsec	3675
	tunnel oper-status-control	3676
	tunnel protection ipsec (IPsec)	3679
	tunnel remote name (IPsec)	3680
	tunnel remote selector	3681
	tunnel security-reprocessing	3683
	tunnel selector paired	3684
	tunnel source (IPsec)	3685
	undebg isakmp	3687
	version (ISAKMP)	3688
Chapter 72:	GRE Tunneling Commands	3689
	Introduction	3689
	interface tunnel (GRE)	3690
	local authentication	3691
	remote authentication	3693
	show interface tunnel (GRE)	3695

tunnel checksum	3696
tunnel dscp	3697
tunnel destination (GRE)	3698
tunnel endpoint	3700
tunnel local name (GRE)	3702
tunnel mode gre	3703
tunnel mode gre multipoint	3704
tunnel protection ipsec (GRE)	3705
tunnel remote name (GRE)	3706
tunnel security-reprocessing	3707
tunnel source (GRE)	3708
tunnel ttl	3710

Chapter 73: OpenVPN Commands 3711

Introduction	3711
ip tcp adjust-mss	3713
ipv6 tcp adjust-mss	3715
show interface tunnel (OpenVPN)	3717
show openvpn connections	3718
show openvpn connections detail	3719
tunnel openvpn tls-version-min	3720
tunnel openvpn authentication	3721
tunnel openvpn cipher	3722
tunnel mode openvpn tap	3724
tunnel mode openvpn tun	3725
tunnel openvpn expiry-bytes	3726
tunnel openvpn expiry-seconds	3727
tunnel openvpn port	3728
tunnel openvpn tagging	3729
tunnel openvpn tls-crypt	3730
tunnel security-reprocessing	3731

Chapter 74: L2TPv2 PPP Commands 3732

Introduction	3732
debug l2tp	3734
destination	3735
encapsulation ppp	3736
ip-version	3738
l2tp tunnel	3739
l2tp unmanaged port	3741
l2tp-profile	3742
local-subaddress	3743
protection ipsec	3744
protection local-name	3745
protection profile	3747
protection remote-name	3748
remote-subaddress	3750
shared-secret	3751
show debugging l2tp	3752
show l2tp session	3753
show l2tp tunnel	3755
show l2tp tunnel config-check	3759

	show running-config l2tp-profile	3761
	show running-config l2tp-tunnel	3762
	source	3763
	version	3764
Chapter 75:	L2TPv3 Ethernet Pseudowire Commands	3765
	Introduction	3765
	interface tunnel (L2TPv3)	3766
	l2tp unmanaged port	3767
	show interface tunnel (L2TPv3)	3768
	tunnel destination (L2TPv3)	3769
	tunnel df	3771
	tunnel local id	3772
	tunnel mode l2tp v3	3773
	tunnel protection ipsec	3774
	tunnel remote id	3775
	tunnel security-reprocessing	3776
	tunnel source (L2TPv3)	3777
Chapter 76:	Transitioning IPv4 to IPv6 Commands	3779
	Introduction	3779
	br-address (software)	3781
	mesh-mode	3782
	method (software)	3783
	rule (software)	3784
	show running-config software-configuration	3786
	show software-configuration	3787
	software-configuration	3789
	tunnel security-reprocessing	3790
	tunnel destination (DS-Lite)	3791
	tunnel mode ds-lite	3792
	tunnel mode lw4o6	3793
	tunnel mode map-e	3794
	tunnel software	3795
	upstream-interface	3796
Chapter 77:	IPv6 Tunneling Commands	3797
	Introduction	3797
	interface tunnel (IPv6)	3798
	ip address (IP Addressing and Protocol)	3799
	ip tcp adjust-mss	3801
	ipv6 address	3803
	ipv6 tcp adjust-mss	3805
	mtu	3807
	show interface tunnel (IPv6)	3809
	tunnel destination (IPv6)	3810
	tunnel dscp	3812
	tunnel mode (IPv6)	3813
	tunnel source (IPv6)	3814
	tunnel ttl	3816

List of Commands

2fa allow-reuse	2386
2fa create user.....	2387
2fa delete user.....	2389
2fa hotp-window-size.....	2390
2fa issuer	2391
2fa label	2393
2fa max-skew.....	2395
2fa reject-unconfigured-users	2396
2fa reset scratch-codes.....	2397
2fa reset skew	2398
2fa skew adjust	2399
2fa totp-window-size	2401
3gpp-info (wireless-network-passpoint-dot11u)	2767
aaa accounting auth-mac	2232
aaa accounting auth-web	2234
aaa accounting commands.....	2236
aaa accounting dot1x.....	2238
aaa accounting login.....	2240
aaa accounting update.....	2243
aaa authentication auth-mac.....	2245
aaa authentication auth-web.....	2247
aaa authentication dot1x	2249
aaa authentication enable default group tacacs+	2251
aaa authentication enable default local.....	2206
aaa authentication enable default local.....	2253

aaa authentication isakmp	2254
aaa authentication login	2255
aaa authentication openvpn	2258
aaa authorization commands	2260
aaa authorization commands	2437
aaa authorization config-commands	2262
aaa authorization config-commands	2439
aaa group server.....	2263
aaa local authentication attempts lockout-time.....	207
aaa local authentication attempts lockout-time.....	2265
aaa local authentication attempts max-fail	208
aaa local authentication attempts max-fail	2266
aaa login fail-delay.....	209
aaa login fail-delay.....	2267
abr-type.....	1143
accept-invalid-sslcert	805
accept-lifetime	945
accounting login	2268
activate	438
active (ping-polling)	3445
active (trigger).....	3405
additional-step-required enable (wireless-network-passpoint-dot11u) ...	2768
address prefix	3134
address range	3136
address-family ipv4 (RIP)	1595
address-family ipv4 (RIP)	947
address-family.....	1234
address-family.....	1593
advertisement-interval.....	2456
ageing-time	518
aggregate-address (IPv6 RIPng)	1007
aggregate-address.....	1236
airtime-fairness enable (wireless-ap-prof-radio).....	2769
alert-thresholding	3547
alias (interface)	3219

alliedware-behavior	948
alternate-checksum-mode	2458
anqp-domain-id (wireless-network-passpoint-hs20)	2771
anqp-element (wireless-network-passpoint-dot11u)	2772
antenna (wireless-ap-prof-radio)	2773
ap	2774
apn	464
application	3495
application-decision	1570
application-decision	1731
application-proxy ip-filter	2502
application-proxy quarantine-vlan	2503
application-proxy redirect-url	2504
application-proxy threat-protection send-summary	2506
application-proxy threat-protection	2505
application-proxy whitelist advertised-address	2507
application-proxy whitelist enable	2508
application-proxy whitelist protection tls	2509
application-proxy whitelist server	2510
application-proxy whitelist trustpoint (deprecated)	2512
ap-profile (wireless)	2775
ap-profile (wireless-ap)	2776
area authentication ipsec spi	1144
area authentication	1037
area default-cost (IPv6 OSPF)	1146
area default-cost	1036
area encryption ipsec spi esp	1147
area filter-list	1038
area nssa	1039
area range (IPv6 OSPF)	1150
area range	1041
area stub (IPv6 OSPF)	1152
area stub	1043
area virtual-link (IPv6 OSPF)	1153
area virtual-link authentication ipsec spi	1155

area virtual-link encryption ipsec spi	1157
area virtual-link	1044
area-link	2513
arp log	747
arp opportunistic-nd	1598
arp opportunistic-nd	750
arp	1596
arp	745
arp-aging-timeout	744
arp-loose-check	752
arp-reply-bc-dmac	754
association-advertisement enable	2777
atmf area password	2520
atmf area	2518
atmf authorize provision	2524
atmf authorize	2522
atmf backup area-masters delete	2527
atmf backup area-masters enable	2528
atmf backup area-masters now	2529
atmf backup area-masters synchronize	2530
atmf backup bandwidth	2531
atmf backup delete	2532
atmf backup enable	2533
atmf backup guests delete	2534
atmf backup guests enable	2535
atmf backup guests now	2536
atmf backup guests synchronize	2537
atmf backup now	2538
atmf backup redundancy enable	2540
atmf backup server	2541
atmf backup stop	2543
atmf backup synchronize	2544
atmf backup	2526
atmf cleanup	2545
atmf container login	2547

atmf container.....	2546
atmf controller	2548
atmf distribute firmware	2549
atmf domain vlan.....	2551
atmf enable	2554
atmf group (membership)	2555
atmf guest-class	2557
atmf log-verbose	2559
atmf management subnet	2560
atmf management vlan	2563
atmf master	2565
atmf mtu.....	2566
atmf network-name	2567
atmf provision (interface)	2568
atmf provision node	2569
atmf reboot-rolling	2571
atmf recover guest.....	2577
atmf recover led-off.....	2578
atmf recover over-eth.....	2579
atmf recover.....	2575
atmf recovery-server.....	2580
atmf remote-login	2582
atmf restricted-login	2584
atmf retry guest-link	2586
atmf secure-mode certificate expire	2589
atmf secure-mode certificate expiry	2590
atmf secure-mode certificate renew	2591
atmf secure-mode enable-all.....	2592
atmf secure-mode	2587
atmf select-area	2594
atmf topology-gui enable.....	139
atmf topology-gui enable.....	2595
atmf trustpoint	2596
atmf virtual-crosslink	2598
atmf virtual-link description.....	2603

atmf virtual-link protection	2604
atmf virtual-link	2600
atmf working-set	2606
atmf-arealink	2515
atmf-link	2517
attribute (radsrv-grp)	2345
auth auth-fail vlan	2108
auth critical	2110
auth dhcp-framed-ip-lease	2111
auth dynamic-vlan-creation	2113
auth guest-vlan forward	2117
auth guest-vlan	2115
auth host-mode	2119
auth log	2121
auth max-suppliant tagged-vlan	2125
auth max-suppliant untagged-vlan	2127
auth max-suppliant	2123
auth multi-vlan-session	2129
auth priority	2130
auth profile (global)	2132
auth profile (interface)	2133
auth reauthentication	2134
auth roaming disconnected	2135
auth roaming enable	2137
auth supplicant-ip	2139
auth supplicant-mac	2141
auth timeout connect-timeout	2144
auth timeout quiet-period	2146
auth timeout reauth-period	2147
auth timeout server-timeout	2149
auth timeout supp-timeout	2151
auth two-step enable	2154
auth two-step order	2156
auth vlan-restriction	2152
authentication (ldap-server)	2290

authentication (wireless-sec-wep).....	2778
authentication.....	2347
auth-mac accounting.....	2158
auth-mac authentication.....	2159
auth-mac enable.....	2160
auth-mac method.....	2162
auth-mac password.....	2164
auth-mac reauth-relearning.....	2165
auth-mac static.....	2166
auth-mac username.....	2167
authorization commands.....	2269
authorization commands.....	2440
auth-web accounting.....	2168
auth-web authentication.....	2169
auth-web enable.....	2170
auth-web forward.....	2172
auth-web idle-timeout enable.....	2175
auth-web idle-timeout timeout.....	2176
auth-web max-auth-fail.....	2177
auth-web method.....	2179
auth-web-server dhcp ipaddress.....	2180
auth-web-server dhcp lease.....	2182
auth-web-server dhcp-wpad-option.....	2183
auth-web-server host-name.....	2184
auth-web-server intercept-port.....	2185
auth-web-server ipaddress.....	2187
auth-web-server ip-conflict-prefer-newer-supPLICANT.....	2186
auth-web-server login-url.....	2189
auth-web-server page language.....	2188
auth-web-server page logo.....	2190
auth-web-server page sub-title.....	2191
auth-web-server page success-message.....	2192
auth-web-server page title.....	2193
auth-web-server page welcome-message.....	2194
auth-web-server ping-poll enable.....	2195

auth-web-server ping-poll failcount	2196
auth-web-server ping-poll interval	2197
auth-web-server ping-poll reauth-timer-refresh	2198
auth-web-server ping-poll timeout	2199
auth-web-server ping-poll type	2200
auth-web-server port	2202
auth-web-server redirect-delay-time	2203
auth-web-server redirect-url	2204
auth-web-server session-keep	2205
auth-web-server ssl intercept-port	2207
auth-web-server ssl	2206
auth-web-server trustpoint	2208
autoboot enable	155
auto-cost reference bandwidth (IPv6 OSPF)	1160
auto-cost reference bandwidth	1047
auto-discovery disable	2779
auto-summary (BGP only)	1239
backpressure	485
band	2780
band-steering (wireless-network)	2781
bandwidth (wireless-ap-prof-radio)	2782
bandwidth	1049
bandwidth	1162
banner display external-manager	275
banner exec	276
banner external-manager	278
banner login (SSH)	3348
banner login (system)	280
banner motd	282
base-dn	2292
bcast-key-refresh-interval (wireless-sec-osen)	2783
bcast-key-refresh-interval (wireless-sec-wpa-ent)	2784
bcast-key-refresh-interval (wireless-sec-wpa-psnl)	2785
bgp aggregate-nexthop-check	1241
bgp always-compare-med	1242

bgp bestpath as-path ignore.....	1244
bgp bestpath compare-confed-aspath	1245
bgp bestpath compare-routerid.....	1246
bgp bestpath med remove-recv-med	1249
bgp bestpath med remove-send-med.....	1250
bgp bestpath med.....	1247
bgp client-to-client reflection	1251
bgp cluster-id	1252
bgp confederation identifier	1254
bgp confederation peers.....	1255
bgp config-type	1257
bgp dampening	1259
bgp damp-peer-oscillation (BGP only).....	1261
bgp default ipv4-unicast	1262
bgp default local-preference (BGP only)	1263
bgp deterministic-med	1264
bgp enforce-first-as.....	1266
bgp fast-external-failover	1267
bgp graceful-restart graceful-reset	1270
bgp graceful-restart	1268
bgp log-neighbor-changes	1271
bgp memory maxallocation.....	1273
bgp nexthop-trigger delay.....	1275
bgp nexthop-trigger enable	1276
bgp nexthop-trigger-count	1274
bgp rfc1771-path-select (BGP only).....	1277
bgp rfc1771-strict (BGP only).....	1278
bgp router-id.....	1279
bgp scan-time (BGP only)	1281
bgp update-delay	1282
bind authenticate root-dn	2293
blacklist	3557
boot config-file backup.....	158
boot config-file.....	156
boot system backup	161

boot system	159
bootfile	3062
br-address (software)	3781
bridge	519
bridge-group (amf-container)	2608
bridge-group	520
browser-only (web-redirect)	252
bss-trans-manage enable	2787
capability opaque	1050
capability restart	1051
captive-portal virtual-ip	2788
captive-portal	2786
category action (IPS)	3548
cd	162
channel (wireless-ap-radio)	2790
channel-group	640
channels (wireless-ap-prof-radio)	2789
chat-script	466
cid	467
ciphers (wireless-sec-osen)	2791
ciphers (wireless-sec-wpa-ent)	2792
ciphers (wireless-sec-wpa-psnl)	2793
circuit-failover	2459
cisco-metric-behavior (RIP)	950
class (htb)	2022
class (priority)	2024
class (wrr)	2026
clear aaa local user lockout	210
clear aaa local user lockout	2271
clear application-proxy threat-protection	2610
clear arp-cache	1600
clear arp-cache	755
clear atmf links statistics	2613
clear atmf links virtual	2612
clear atmf links	2611

clear atmf recovery-file	2614
clear atmf secure-mode certificates	2615
clear atmf secure-mode statistics	2616
clear bgp (ASN)	1286
clear bgp (IPv4 or IPv6 address)	1284
clear bgp *	1283
clear bgp external	1287
clear bgp ipv6 (ASN) (BGP4+ only)	1292
clear bgp ipv6 (ipv6 address) (BGP4+ only)	1289
clear bgp ipv6 dampening (BGP4+ only)	1290
clear bgp ipv6 external (BGP4+ only)	1293
clear bgp ipv6 flap-statistics (BGP4+ only)	1291
clear bgp ipv6 peer-group (BGP4+ only)	1294
clear bgp peer-group	1288
clear counter ipv6 dhcp-client	3138
clear counter ipv6 dhcp-server	3139
clear exception log	342
clear firewall connections	3471
clear ip bgp (ASN) (BGP only)	1301
clear ip bgp (IPv4) (BGP only)	1297
clear ip bgp (IPv4) (BGP only)	1604
clear ip bgp * (BGP only)	1295
clear ip bgp * (BGP only)	1602
clear ip bgp dampening (BGP only)	1299
clear ip bgp external (BGP only)	1302
clear ip bgp flap-statistics (BGP only)	1300
clear ip bgp peer-group (BGP only)	1303
clear ip dhcp binding	3063
clear ip dns forwarding cache	806
clear ip igmp group	1786
clear ip igmp interface	1787
clear ip igmp	1785
clear ip mroute pim sparse-mode	1906
clear ip mroute statistics	1869
clear ip mroute	1868

clear ip ospf process	1052
clear ip pim sparse-mode bsr rp-set *	1904
clear ip pim sparse-mode packet statistics	1905
clear ip prefix-list	1304
clear ip rip route	1606
clear ip rip route	951
clear ipv6 dhcp binding	3140
clear ipv6 dhcp client	3142
clear ipv6 mld group	1839
clear ipv6 mld interface	1840
clear ipv6 mld	1838
clear ipv6 mroute pim sparse-mode	1960
clear ipv6 mroute pim	1959
clear ipv6 mroute statistics	1871
clear ipv6 mroute	1870
clear ipv6 neighbors	868
clear ipv6 ospf process	1163
clear ipv6 pim sparse-mode bsr rp-set *	1961
clear ipv6 rip route	1008
clear isakmp sa	3628
clear lacp counters	642
clear line console	211
clear line vty	212
clear lldp statistics	3263
clear lldp table	3264
clear log buffered	344
clear log external	345
clear log permanent	346
clear log	343
clear mac address-table dynamic	487
clear mac address-table static	488
clear mac-filter counter	522
clear ping-poll	3446
clear port counter	489
clear pppoe-ac statistics	710

clear radius dynamic-authorization counters	2319
clear radius local-server statistics	2353
clear snmp-discovery	3045
clear spanning-tree detected protocols (RSTP and MSTP)	569
clear spanning-tree statistics	568
clear ssh	3349
client (pppoe-relay)	711
client (radsecproxy-srv)	2348
client mutual-authentication	2350
client name-check	2351
client trustpoint	2352
clock set	284
clock summer-time date	285
clock summer-time recurring	287
clock timezone	289
clone (amf-provision)	2617
community read-only (wireless-ap-prof-snmp)	2794
community trap (wireless-ap-prof-snmp)	2796
compatible rfc1583	1053
configure boot config (amf-provision)	2619
configure boot system (amf-provision)	2621
configure terminal	128
conn-capability protocol (wireless-network-passpoint-hs20)	2797
connection-limit (firewall)	3472
connection-log events	347
connection-log events	3474
consecutive probe loss	1733
copy (amf-provision)	2623
copy (filename)	163
copy buffered-log	348
copy debug	165
copy fdb-radius-users (to file)	2354
copy local-radius-user-db (from file)	2356
copy local-radius-user-db (to file)	2357
copy permanent-log	349

copy proxy-autoconfig-file	2210
copy running-config	166
copy startup-config	167
copy web-auth-https-file	2211
copy zmodem	168
counters detailed	3566
country-code	2799
create (amf-provision)	2624
create autoboot	169
critical-interval	3447
crypto ipsec profile	3629
crypto isakmp key	3631
crypto isakmp peer	3634
crypto isakmp profile	3636
crypto key destroy hostkey	3350
crypto key destroy userkey	3351
crypto key generate hostkey	3352
crypto key generate rsa	2411
crypto key generate userkey	3354
crypto key pubkey-chain knownhosts	1608
crypto key pubkey-chain knownhosts	3355
crypto key pubkey-chain userkey	3357
crypto key zeroize	2412
crypto pki authenticate	2413
crypto pki enroll local (deleted)	2358
crypto pki enroll local local-radius-all-users (deleted)	2359
crypto pki enroll local user (deleted)	2360
crypto pki enroll user	2415
crypto pki enroll	2414
crypto pki export local pem (deleted)	2361
crypto pki export local pkcs12 (deleted)	2362
crypto pki export pem	2417
crypto pki export pkcs12	2418
crypto pki import pem	2420
crypto pki import pkcs12	2422

crypto pki trustpoint local (deleted)	2363
crypto pki trustpoint	2423
custom-failure	807
custom-success	808
day (wireless-task)	2800
day	3406
ddns enable	809
ddns-update now	812
ddns-update-method	810
deadtime (ldap-server)	2294
deadtime (RADIUS server group)	2320
deauth-req-timeout (wireless-network-passpoint-hs20)	2801
debug 2fa	2402
debug aaa	2272
debug atmf packet	2628
debug atmf	2626
debug bgp (BGP only)	1305
debug core-file	290
debug crypto pki (deleted)	2364
debug ddns	813
debug dot1x	2074
debug firewall	3476
debug igmp	1788
debug ip dns forwarding	814
debug ip packet interface	757
debug ipv6 ospf events	1164
debug ipv6 ospf ifsm	1165
debug ipv6 ospf lsa	1166
debug ipv6 ospf nfsm	1167
debug ipv6 ospf packet	1168
debug ipv6 ospf route	1169
debug ipv6 pim sparse-mode packet	1964
debug ipv6 pim sparse-mode timer	1965
debug ipv6 pim sparse-mode	1962
debug ipv6 rip	1009

debug isakmp	3638
debug l2tp	3734
debug lacp	643
debug ldap client.....	2295
debug linkmon	1735
debug lldp	3265
debug mail	3319
debug mld	1841
debug mstp (RSTP and STP).....	570
debug nsm mcast	1873
debug nsm mcast6	1874
debug nsm	1872
debug ospf events.....	1054
debug ospf ifsm	1055
debug ospf lsa.....	1056
debug ospf nasm	1057
debug ospf nsm	1058
debug ospf packet.....	1059
debug ospf route	1060
debug pim sparse-mode timer	1908
debug pim sparse-mode	1907
debug ping-poll	3448
debug platform packet	490
debug policy-based-routing	1572
debug ppp	666
debug pppoe-ac.....	712
debug radius	2321
debug rip	953
debug snmp.....	3220
debug ssh client	3359
debug ssh server	3360
debug traffic-control.....	2028
debug trigger	3408
debug vrrp events.....	2462
debug vrrp packet.....	2463

debug vrrp	2461
debug wireless	2802
default log buffered	350
default log console	351
default log email	352
default log external.....	353
default log host.....	354
default log monitor.....	355
default log permanent.....	356
default-action	523
default-information originate (IPv6 RIPng).....	1010
default-information originate (RIP)	954
default-information originate	1061
default-information originate	1170
default-metric (IPv6 OSPF)	1171
default-metric (IPv6 RIPng).....	1011
default-metric (OSPF)	1062
default-metric (RIP)	1610
default-metric (RIP)	955
default-protocol-action	525
default-router	3065
delete (amf-provision)	2631
delete debug.....	171
delete mail	3320
delete	170
description (amf-container)	2635
description (auth-profile)	2212
description (domain-list).....	815
description (interface)	442
description (ping-polling).....	3449
description (trigger)	3409
description (VRF)	1611
description (wireless-ap)	2804
description (wireless-ap-prof)	2805
description (wireless-mac-flt)	2806

description (wireless-network)	2807
description (wireless-sc-prof).....	2808
description (wireless-task)	2809
description (wireless-trigger).....	2810
destination (linkmon-probe)	1737
destination l2tp	713
destination	3735
dgaf enable (wireless-network-passpoint-hs20).....	2811
dir.....	172
disable (Privileged Exec mode)	129
disable (VRRP)	2464
discovery.....	2633
distance (BGP and BGP4+)	1307
distance (IPv6 OSPF)	1172
distance (OSPF).....	1063
distance (RIP).....	1612
distance (RIP).....	956
distribute-list (IPv6 RIPng).....	1012
distribute-list (OSPF)	1065
distribute-list (RIP)	1613
distribute-list (RIP)	957
dns-server (DHCPv6).....	3143
dns-server.....	3066
do.....	130
domain.....	816
domain-name (DHCPv6)	3145
domain-name (wireless-network-passpoint-dot11u)	2812
domain-name	3067
domain-style	2365
dot11u (wireless-network-passpoint).....	2813
dot1x accounting.....	2072
dot1x authentication	2073
dot1x control-direction	2075
dot1x eap	2077
dot1x eapol-version	2078

dot1x initialize interface	2079
dot1x initialize supplicant.....	2080
dot1x keytransmit	2081
dot1x max-auth-fail.....	2082
dot1x max-reauth-req	2084
dot1x port-control.....	2086
dot1x timeout tx-period	2088
dpd-interval.....	3640
dpd-timeout	3641
dpi.....	3567
dport.....	3497
dscp (linkmon-probe).....	1739
dscp	3499
dtim-period	2814
dup-auth-received (wireless-network).....	2815
duplex	492
dynamic-vlan enable (wireless-sec-osen)	2816
echo	439
edit (filename).....	175
edit	174
egress interface (linkmon-probe).....	1740
egress-vlan-id (radsrv-grp)	2366
egress-vlan-name (radsrv-grp)	2367
emergency-mode usb enable	2819
emergency-mode usb key	2820
emergency-mode	2818
emergency-service-reachable enable (wireless-network-passpoint-dot11u)	2822
enable (dpi)	3568
enable (linkmon-probe).....	1741
enable (nat)	3530
enable (Privileged Exec mode)	131
enable (VRRP)	2465
enable (web-redirect).....	253
enable (wireless).....	2823

enable (wireless-ap)	2824
enable (wireless-ap-prof-radio).....	2825
enable (wireless-ap-prof-snmp)	2817
enable (wireless-network-cp)	2826
enable (wireless-network-passpoint)	2827
enable (wireless-sec-wep).....	2828
enable (wireless-task)	2829
enable (wireless-wds).....	2830
enable db-summary-opt	1067
enable password	213
enable secret (deprecated).....	215
encapsulation dot1q.....	662
encapsulation ppp.....	3736
encapsulation ppp.....	468
encapsulation ppp.....	669
end	133
endpoint-source.....	3580
enrollment (ca-trustpoint)	2424
entry (endpoint-manual).....	3582
erase factory-default.....	176
erase factory-default.....	2636
erase proxy-autoconfig-file	2213
erase startup-config	177
erase web-auth-https-file	2214
exclude app	254
exclude dst-ip	256
exclude ip.....	258
exclude mac.....	259
exclude url	260
exclude-entry (endpoint-manual)	3584
exclude-entry (endpoint-office365)	3586
exec-timeout.....	216
exit.....	134
exit-address-family	1309
expect-html-response	817

export map.....	1614
external-page-url.....	2831
fail-count.....	3450
filter-endpoint include all.....	3591
filter-endpoint.....	3588
filter-entry exclude type.....	3595
filter-entry exclude.....	3593
filter-entry.....	2832
fingerprint (ca-trustpoint).....	2425
firewall.....	3475
flowcontrol (switch port).....	493
flowcontrol hardware (asyn/console).....	218
follow-redirects.....	818
force-disable (wireless-ap-radio).....	2834
fullupdate (RIP).....	1615
fullupdate (RIP).....	1618
fullupdate (RIP).....	958
gas-address-behavior (wireless-network-passpoint-dot11u).....	2835
gas-comeback-delay (wireless-network-passpoint-dot11u).....	2836
get-before-submit.....	819
get-params.....	820
group (radsrv).....	2368
group-attribute.....	2297
group-dn.....	2298
ha associate.....	2451
help radius-attribute.....	2370
help.....	135
hessid (wireless-network-passpoint-dot11u).....	2837
hide-ssid (wireless-network).....	2838
host (DHCP).....	3068
host (ldap-server).....	2299
host (network).....	3501
host area.....	1068
hostname (application).....	3570
host-name (ddns-update-method).....	821

hostname	291
hs20 (wireless-network-passpoint)	2839
http client vrf	141
http client vrf	1616
http log webapi-requests	140
http port	143
http secure-port	144
http trustpoint	145
http vrf	142
http vrf	1617
http-enable	2637
hwtype	2840
icmp-code	3503
icmp-type	3505
identity (amf-provision)	2639
idle-time (web-redirect)	262
import map	1620
index	2842
initialization-button enable	2843
instance priority (MSTP)	574
instance vlan (MSTP)	576
interface (PPP)	671
interface (to configure)	443
interface (traffic-control)	2029
interface dynamic-virtual-bandwidth	2031
interface tunnel (GRE)	3690
interface tunnel (IPsec)	3642
interface tunnel (IPv6)	3798
interface tunnel (L2TPv3)	3766
internet-access enable (wireless-network-passpoint-dot11u)	2844
interval (linkmon-probe)	1742
ip (ping-polling)	3451
ip address (host)	3507
ip address (IP Addressing and Protocol)	3799
ip address (IP Addressing and Protocol)	759

ip address dhcp	3069
ip address negotiated.....	672
ip community-list expanded	1312
ip community-list standard	1314
ip community-list.....	1310
ip ddns-update-method	822
ip dhcp bootp ignore	3071
ip dhcp leasequery enable	3072
ip dhcp option.....	3073
ip dhcp pool.....	3075
ip dhcp-client default-route distance	3076
ip dhcp-client request vendor-identifying-specific	3078
ip dhcp-client vendor-identifying-class	3079
ip dhcp-relay agent-option checking	3082
ip dhcp-relay agent-option checking	3148
ip dhcp-relay agent-option remote-id	3083
ip dhcp-relay agent-option remote-id	3149
ip dhcp-relay agent-option	3080
ip dhcp-relay agent-option	3146
ip dhcp-relay information policy	3084
ip dhcp-relay information policy	3150
ip dhcp-relay maxhops	3086
ip dhcp-relay maxhops	3152
ip dhcp-relay max-message-length.....	3087
ip dhcp-relay max-message-length.....	3153
ip dhcp-relay server-address	3089
ip dhcp-relay server-address	3155
ip dhcp-relay use-client-side-address.....	3091
ip directed-broadcast.....	761
ip dns forwarding cache	824
ip dns forwarding dead-time.....	826
ip dns forwarding domain-list	827
ip dns forwarding retry	828
ip dns forwarding source-interface	829
ip dns forwarding timeout	830

ip dns forwarding.....	823
ip domain-list.....	831
ip domain-lookup	832
ip domain-name.....	834
ip extcommunity-list expanded	1316
ip extcommunity-list standard	1318
ip forwarding.....	763
ip forward-protocol udp	764
ip gratuitous-arp-link	766
ip helper-address	768
ip icmp error-interval	770
ip icmp-timestamp	771
ip igmp flood specific-query	1790
ip igmp last-member-query-count	1791
ip igmp last-member-query-interval.....	1792
ip igmp maximum-groups	1793
ip igmp mroute-proxy	1795
ip igmp proxy-service.....	1796
ip igmp querier-timeout	1798
ip igmp query-holdtime	1799
ip igmp query-interval	1801
ip igmp query-max-response-time	1803
ip igmp ra-option.....	1805
ip igmp robustness-variable	1806
ip igmp snooping fast-leave.....	1808
ip igmp snooping mrouter	1809
ip igmp snooping querier.....	1810
ip igmp snooping report-suppression	1811
ip igmp snooping routermode	1812
ip igmp snooping source-timeout.....	1814
ip igmp snooping tcn query solicit	1815
ip igmp snooping.....	1807
ip igmp source-address-check	1817
ip igmp startup-query-count.....	1818
ip igmp startup-query-interval	1819

ip igmp trusted	1820
ip igmp version	1821
ip igmp	1789
ip limited-local-proxy-arp	3531
ip limited-local-proxy-arp	772
ip local-proxy-arp	774
ip mroute	1875
ip multicast handle-igmp-immediately	1877
ip multicast route	1878
ip multicast route-limit	1880
ip multicast wrong-vif-suppression	1881
ip multicast-routing	1882
ip name-server preferred-order	837
ip name-server	835
ip ospf authentication	1069
ip ospf authentication-key	1070
ip ospf cost	1071
ip ospf database-filter	1072
ip ospf dead-interval	1073
ip ospf disable all	1074
ip ospf hello-interval	1075
ip ospf message-digest-key	1076
ip ospf mtu	1078
ip ospf mtu-ignore	1079
ip ospf network	1080
ip ospf priority	1081
ip ospf resync-timeout	1082
ip ospf retransmit-interval	1083
ip ospf transmit-delay	1084
ip pim anycast-rp	1910
ip pim bsr-border	1911
ip pim bsr-candidate	1912
ip pim cisco-register-checksum	1913
ip pim crp-cisco-prefix	1914
ip pim dr-priority	1915

ip pim exclude-genid	1916
ip pim ext-srcs-directly-connected	1917
ip pim hello-holdtime (PIM-SM)	1918
ip pim hello-interval (PIM-SM)	1919
ip pim ignore-rp-set-priority	1920
ip pim jp-timer	1921
ip pim register-rate-limit	1922
ip pim register-rp-reachability	1923
ip pim register-source	1924
ip pim register-suppression	1925
ip pim rp-address	1926
ip pim rp-candidate	1928
ip pim rp-register-kat	1929
ip pim sparse-mode join-prune-batching	1931
ip pim sparse-mode passive	1933
ip pim sparse-mode wrong-vif-suppression	1934
ip pim sparse-mode	1930
ip pim spt-threshold	1936
ip pim ssm	1937
ip policy-route	1573
ip policy-route	1743
ip prefix-list	1320
ip prefix-list	960
ip proxy-arp	775
ip radius source-interface	2322
ip redirects	776
ip rip authentication key-chain	962
ip rip authentication mode	964
ip rip authentication string	966
ip rip receive version	969
ip rip receive-packet	968
ip rip send version 1-compatible	973
ip rip send version	971
ip rip send-packet	970
ip rip split-horizon	974

ip route static inter-vrf	1619
ip route vrf	1621
ip route	923
ip subnet	3509
ip summary-address rip	959
ip tacacs source-interface	2442
ip tcp adjust-mss	3713
ip tcp adjust-mss	3801
ip tcp adjust-mss	445
ip tcp adjust-mss	674
ip tcp synack-retries	777
ip tcp timeout established	3477
ip tcp timeout established	778
ip tcp-timestamp	779
ip tftp source-interface	178
ip tftp vrf	1624
ip tftp vrf	179
ip unnumbered	676
ip unreachable	780
ip vrf forwarding	1637
ip vrf	1625
ip-address (wireless-ap)	2847
ip-addr-type-availability (wireless-network-passpoint-dot11u)	2845
ips	3549
ipv6 address (DHCPv6 PD)	3157
ipv6 address (host)	3511
ipv6 address autoconfig	871
ipv6 address dhcp	3159
ipv6 address suffix	873
ipv6 address	3803
ipv6 address	869
ipv6 ddns-update-method	838
ipv6 dhcp client pd	3161
ipv6 dhcp option	3163
ipv6 dhcp pool	3165

ipv6 dhcp server.....	3167
ipv6 enable.....	874
ipv6 eui64-linklocal.....	876
ipv6 forwarding.....	877
ipv6 icmp error-interval.....	878
ipv6 local pool.....	3169
ipv6 mld last-member-query-count.....	1843
ipv6 mld last-member-query-interval.....	1844
ipv6 mld querier-timeout.....	1845
ipv6 mld query-interval.....	1846
ipv6 mld query-max-response-time.....	1847
ipv6 mld robustness-variable.....	1848
ipv6 mld snooping fast-leave.....	1851
ipv6 mld snooping mrouter.....	1852
ipv6 mld snooping querier.....	1854
ipv6 mld snooping report-suppression.....	1855
ipv6 mld snooping.....	1849
ipv6 mld ssm-map enable.....	1857
ipv6 mld static-group.....	1858
ipv6 mld version.....	1860
ipv6 mld.....	1842
ipv6 mroute.....	1883
ipv6 multicast forward-slow-path-packet.....	879
ipv6 multicast route.....	1885
ipv6 multicast route-limit.....	1888
ipv6 multicast-routing.....	1889
ipv6 multihoming.....	880
ipv6 nd accept-ra-default-routes.....	881
ipv6 nd accept-ra-pinfo.....	882
ipv6 nd current-hoplimit.....	883
ipv6 nd dns search-list.....	885
ipv6 nd dns-server.....	886
ipv6 nd managed-config-flag.....	888
ipv6 nd minimum-ra-interval.....	889
ipv6 nd other-config-flag.....	891

ipv6 nd prefix (DHCPv6)	3171
ipv6 nd prefix	892
ipv6 nd proxy interface	894
ipv6 nd ra-interval	896
ipv6 nd ra-lifetime	897
ipv6 nd reachable-time	899
ipv6 nd retransmission-time	901
ipv6 nd route-information	903
ipv6 nd router-preference	904
ipv6 nd suppress-ra	905
ipv6 neighbor	906
ipv6 opportunistic-nd	907
ipv6 ospf authentication spi	1174
ipv6 ospf cost	1176
ipv6 ospf dead-interval	1177
ipv6 ospf display route single-line	1178
ipv6 ospf encryption spi esp	1179
ipv6 ospf hello-interval	1182
ipv6 ospf neighbor	1183
ipv6 ospf network	1185
ipv6 ospf priority	1186
ipv6 ospf retransmit-interval	1187
ipv6 ospf transmit-delay	1188
ipv6 pim anycast-rp	1967
ipv6 pim bsr-border	1969
ipv6 pim bsr-candidate	1971
ipv6 pim cisco-register-checksum	1973
ipv6 pim crp-cisco-prefix	1974
ipv6 pim dr-priority	1975
ipv6 pim exclude-genid	1977
ipv6 pim ext-srcs-directly-connected	1978
ipv6 pim hello-holdtime	1979
ipv6 pim hello-interval	1981
ipv6 pim ignore-rp-set-priority	1982
ipv6 pim jp-timer	1983

ipv6 pim neighbor-filter.....	1984
ipv6 pim register-rate-limit.....	1985
ipv6 pim register-rp-reachability.....	1986
ipv6 pim register-source.....	1987
ipv6 pim register-suppression.....	1988
ipv6 pim rp embedded.....	1992
ipv6 pim rp-address.....	1989
ipv6 pim rp-candidate.....	1991
ipv6 pim rp-register-kat.....	1993
ipv6 pim sparse-mode passive.....	1995
ipv6 pim sparse-mode.....	1994
ipv6 pim spt-threshold.....	1996
ipv6 pim ssm.....	1997
ipv6 pim unicast-bsm.....	1998
ipv6 policy-route.....	1575
ipv6 policy-route.....	1746
ipv6 prefix-list.....	1013
ipv6 prefix-list.....	1322
ipv6 rip metric-offset.....	1015
ipv6 rip split-horizon.....	1017
ipv6 route.....	908
ipv6 route.....	926
ipv6 router ospf area.....	1189
ipv6 router rip.....	1018
ipv6 subnet.....	3513
ipv6 tcp adjust-mss.....	3715
ipv6 tcp adjust-mss.....	3805
ipv6 tcp adjust-mss.....	447
ipv6 tcp adjust-mss.....	678
ipv6 tftp source-interface.....	180
ipv6 unreachable.....	910
ip-version (linkmon-probe).....	1745
ip-version.....	3738
jitter.....	1748
keepalive (PPP).....	680

key (wireless-sc-prof)	2848
key (wireless-sec-wep)	2849
key (wireless-sec-wpa-psnl)	2851
key chain	976
key	975
key-string	977
l2tif enable (wireless-network-passpoint-hs20)	2852
l2tp peer-address dns-lookup	714
l2tp peer-address radius-lookup group	716
l2tp peer-address static	717
l2tp profile	719
l2tp tunnel	3739
l2tp unmanaged port	3741
l2tp unmanaged port	3767
l2tp-profile	3742
l3-filtering enable	2033
l3-filtering enable	526
lACP global-passive-mode enable	644
lACP port-priority	645
lACP system-priority	646
lACP timeout	647
latency	1750
ldap-server	2301
lease	3092
led enable	2853
legacy-rates	2854
length (asyn)	220
length (ping-poll data)	3452
length (wireless-sec-wep)	2855
license-cert (amf-provision)	2641
lifetime (IPsec Profile)	3643
lifetime (ISAKMP Profile)	3644
line	221
link-address	3173
linkflap action	495

linkmon group	1752
linkmon probe.....	1755
linkmon probe-history	1753
linkmon profile	1757
lldp faststart-count	3266
lldp holdtime-multiplier	3267
lldp management-address	3268
lldp med-notifications	3269
lldp med-tlv-select.....	3270
lldp non-strict-med-tlv-order-check	3273
lldp notification-interval	3274
lldp notifications	3275
lldp port-number-type.....	3276
lldp reinit.....	3277
lldp run	3278
lldp timer.....	3279
lldp tlv-select.....	3280
lldp transmit receive	3282
lldp tx-delay	3283
load-balancing	1758
local authentication	3691
local-proxy-arp	3533
local-proxy-arp	782
local-subaddress	3743
locate (amf-provision)	2643
location civic-location configuration	3284
location civic-location identifier	3288
location civic-location-id	3289
location coord-location configuration	3290
location coord-location identifier	3292
location coord-location-id	3293
location elin-location	3295
location elin-location-id.....	3296
log buffered (filter)	358
log buffered exclude.....	361

log buffered size.....	364
log buffered.....	357
log console (filter).....	366
log console exclude.....	369
log console.....	365
log date-format.....	372
log email (filter).....	374
log email exclude.....	377
log email time.....	380
log email.....	373
log enable destination.....	2856
log event-host.....	147
log event-host.....	2645
log external (filter).....	384
log external exclude.....	387
log external rotate.....	390
log external size.....	392
log external.....	382
log facility.....	393
log host (filter).....	1631
log host (filter).....	397
log host exclude.....	1628
log host exclude.....	401
log host source.....	404
log host startup-delay.....	405
log host time.....	1635
log host time.....	407
log host.....	1626
log host.....	395
log interval neighbor-ap.....	2857
log monitor (filter).....	409
log monitor exclude.....	412
log permanent (filter).....	416
log permanent exclude.....	419
log permanent size.....	422

log permanent	415
log rotate neighbor-ap.....	2858
log rotate wireless-client.....	2859
log size wireless-client	2860
log trustpoint.....	424
log url-requests.....	3558
log url-requests.....	425
login authentication	2273
login username (wireless-ap).....	2861
login-attribute.....	2303
login-fallback enable	2646
login-password (wireless-ap).....	2862
logout.....	136
log-rate-limit nsm	423
mac address-table acquire	496
mac address-table ageing-time	497
mac address-table static	498
mac-address (wireless-ap).....	2863
mac-auth password.....	2864
mac-auth radius auth group (wireless-network).....	2865
mac-auth username	2866
mac-filter.....	528
mac-filter-group egress.....	527
mac-filter-group.....	529
mac-learning	530
mail from.....	3323
mail smtpserver authentication	3325
mail smtpserver port.....	3327
mail smtpserver	3324
mail.....	3321
management address.....	2868
management-frame-protection enable (wireless-sec-osen)	2869
management-frame-protection enable (wireless-sec-wpa-ent)	2871
management-frame-protection enable (wireless-sec-wpa-psnl)	2873
match as-path.....	1324

match as-path	1529
match community	1325
match community	1530
match interface	1532
match ip address	1533
match ip next-hop	1535
match ipv6 address	1537
match ipv6 next-hop	1539
match metric	1540
match origin	1541
match route-type	1543
match tag	1544
max-clients	2875
max-concurrent-dd (IPv6 OSPF)	1191
max-concurrent-dd	1085
max-fib-routes (VRF)	1638
max-fib-routes	293
max-fib-routes	928
maximum-area	1086
maximum-paths	931
maximum-prefix	978
max-paths	1327
max-sessions	721
max-static-routes (VRF)	1640
max-static-routes	295
max-static-routes	930
member (linkmon-group)	1759
mesh-mode	3782
method (software)	3783
mirror interface	478
mkdir	181
mode (web-redirect)	264
mode (wireless-ap-prof-radio)	2876
mode (wireless-network-cp)	2878
modeltype	2647

move debug.....	183
move rule (firewall)	3478
move rule (nat)	3534
move rule (traffic-control).....	2034
move.....	182
mru jumbo	449
mtu (PPP)	682
mtu	3807
mtu	450
multicast	1890
nai-realm (wireless-network-passpoint-dot11u).....	2880
nas.....	2369
nat	3535
neighbor (IPv6 RIPng).....	1019
neighbor (OSPF)	1087
neighbor (RIP)	979
neighbor activate.....	1328
neighbor advertisement-interval.....	1331
neighbor allowas-in	1334
neighbor as-origination-interval	1337
neighbor attribute-unchanged.....	1339
neighbor capability graceful-restart	1342
neighbor capability orf prefix-list.....	1345
neighbor capability route-refresh	1348
neighbor collide-established.....	1351
neighbor default-originate.....	1354
neighbor description	1357
neighbor disallow-infinite-holdtime.....	1360
neighbor dont-capability-negotiate	1362
neighbor ebgp-multihop	1365
neighbor enforce-multihop	1368
neighbor filter-list	1371
neighbor interface.....	1374
neighbor local-as	1376
neighbor maximum-prefix	1379

neighbor next-hop-self	1382
neighbor next-hop-self	1641
neighbor override-capability	1385
neighbor passive	1387
neighbor password	1390
neighbor password	1647
neighbor peer-group (add a neighbor)	1394
neighbor peer-group (create a peer-group)	1396
neighbor port	1397
neighbor prefix-list	1400
neighbor remote-as	1403
neighbor remote-as	1644
neighbor remove-private-AS (BGP only)	1406
neighbor restart-time	1408
neighbor route-map	1411
neighbor route-reflector-client (BGP only)	1415
neighbor route-server-client (BGP only)	1417
neighbor send-community	1418
neighbor shutdown	1422
neighbor soft-reconfiguration inbound	1424
neighbor timers	1427
neighbor transparent-as	1430
neighbor transparent-nexthop	1432
neighbor unsuppress-map	1434
neighbor update-source	1437
neighbor version (BGP only)	1441
neighbor weight	1443
neighbor-ap-detection enable	2882
neighbor-managed-ap-detection enable	2883
network (BGP and BGP4+)	1446
network (DHCP)	3094
network (RIP)	1651
network (RIP)	980
network (wireless)	2888
network (zone)	3515

network area	1088
network synchronization.....	1449
network-auth-type (wireless-network-passpoint-dot11u)	2884
network-type (wireless-network-passpoint-dot11u).....	2886
next-server	3095
no crypto pki certificate.....	2427
no debug all.....	296
no debug isakmp.....	3645
normal-interval.....	3453
ntp authentication-key	3200
ntp broadcastdelay.....	3201
ntp designated-server enable	2890
ntp designated-server period	2891
ntp designated-server	2889
ntp master	3202
ntp peer.....	3203
ntp rate-limit	3205
ntp restrict	3206
ntp server	3208
ntp source.....	3210
obey-form.....	839
operating-class (wireless-network-passpoint-hs20)	2892
operator (wireless-network-passpoint-hs20).....	2893
optimistic-nd.....	783
optimistic-nd.....	911
option (DHCPv6).....	3175
option.....	3096
ospf abr-type.....	1090
ospf restart grace-period.....	1091
ospf restart helper.....	1092
ospf router-id.....	1094
osu ssid	2905
osu status enable.....	2907
osu-providers friendly-name lang name	2894
osu-providers icon lang file	2896

osu-providers method-list	2898
osu-providers nai	2900
osu-providers server-uri	2902
osu-providers service-desc lang desc	2903
outdoor	2908
overflow database external	1096
overflow database	1095
pac-file http-server port	3597
pac-file proxy-address	3599
pac-file template	3600
page-proxy-url	2909
parser-updates enable	3602
parser-updates interval	3603
passive-interface (IPv6 OSPF)	1192
passive-interface (IPv6 RIPng)	1020
passive-interface (OSPF)	1097
passive-interface (RIP)	1653
passive-interface (RIP)	982
passpoint	2910
password (ddns-update-method)	840
peer (wireless-wds)	2911
peer default ip address	683
peer neighbor-route	685
permit host (wireless-ap-prof-snmpp)	2912
pfs	3646
ping ipv6	912
ping	1654
ping	784
ping-poll	3454
pktloss	1761
platform multicast-ratelimit	1891
platform multicast-ratelimit	499
polarity	500
policy (traffic-control)	2035
policy-based-routing enable	1578

policy-based-routing	1577
port (ldap-server)	2305
port (wireless-ap-prof-snmp)	2913
power (wireless-ap-radio)	2914
ppp authentication refuse	689
ppp authentication	687
ppp hostname	691
ppp ipcp dns suffix-list	695
ppp ipcp dns suffix-list	843
ppp ipcp dns	693
ppp ipcp dns	841
ppp ipcp ip-override	697
ppp password	698
ppp service-name (PPPoE)	699
ppp timeout idle	700
ppp username	701
ppp-auth-protocol	722
pppoe-ac	723
pppoe-ac-service	724
pppoe-relay	725
pre-authentication enable (wireless-sec-osen)	2915
pre-authentication enable (wireless-sec-wpa-ent)	2916
preempt-mode	2466
preference	1763
prefix-delegation pool	3177
priority	2468
privilege level	223
probe enable	3098
probe packets	3099
probe timeout	3100
probe type	3101
protect (firewall)	3479
protect (IPS)	3550
protect (url-filter)	3559
protection ipsec	3744

protection local-name	3745
protection profile	3747
protection remote-name	3748
protocol ethii (macfilter)	531
protocol novell (macfilter)	533
protocol sap (macfilter)	535
protocol snap (macfilter)	537
protocol	3517
provider (dpi)	3571
proxy-arp enable	2917
proxy-auth	726
proxy-host (web-redirect)	266
proxy-port	2274
pwd	184
qos-map-set (wireless-network-passpoint-dot11u)	2918
radio (wireless-ap)	2919
radio (wireless-ap-profile)	2920
radius accounting enable	2921
radius auth group (wireless-network-cp)	2922
radius auth group (wireless-sec-wpa-ent)	2925
radius authentication group (wireless-sec-osen)	2924
radius dynamic-authorization-client	2323
radius-secure-proxy aaa	2275
radius-secure-proxy local-server	2372
radius-server deadtime	2324
radius-server host	1656
radius-server host	2325
radius-server key	2329
radius-server local	2373
radius-server retransmit	2330
radius-server timeout	2332
range	3102
rd (route distinguisher)	1660
reboot	298
receive-packet-scheduler	299

recv-buffer-size (IPv6 RIPng)	1021
recv-buffer-size (RIP)	983
red-curve	2037
redirect-url	2926
redistribute (into BGP or BGP4+)	1450
redistribute (into BGP or BGP4+)	1661
redistribute (IPv6 OSPF)	1193
redistribute (IPv6 RIPng)	1022
redistribute (OSPF)	1098
redistribute (OSPF)	1663
redistribute (RIP)	1665
redistribute (RIP)	984
region (MSTP)	578
rekey	3648
reload	301
remote authentication	3693
remote-subaddress	3750
repeat	3410
repeat-time (web-redirect)	268
restart bgp graceful (BGP only)	1452
restart ipv6 ospf graceful	1195
restart ospf graceful	1100
restart rip graceful	986
retransmit (ldap-server)	2306
retry-interval	845
revision (MSTP)	579
rip restart grace-period	987
rmdir	185
rmon alarm	3333
rmon collection history	3336
rmon collection stats	3337
rmon event	3338
roaming-oi (wireless-network-passpoint-dot11u)	2929
rogue-ap-detection enable (wireless)	2928
route (IPv6 RIPng)	1023

route (RIP).....	1667
route (RIP).....	988
route.....	3103
route-map.....	1454
route-map.....	1545
router bgp	1453
router ipv6 ospf	1196
router ipv6 rip.....	1024
router ipv6 vrrp (interface)	2470
router ospf	1101
router ospf	1670
router rip.....	989
router vrrp (interface).....	2472
router-id (IPv6 OSPF).....	1197
router-id (VRF).....	1672
router-id	1103
route-target	1668
rsa-keypair (ca-trustpoint)	2428
rule (firewall)	3480
rule (macfilter).....	539
rule (nat)	3536
rule (software)	3784
rule (traffic-control).....	2039
rule ip (macfilter)	541
rule ipv6 (macfilter).....	543
sample-size (linkmon-probe).....	1765
sample-size.....	3455
sc-channel.....	2931
sc-profile.....	2930
script.....	3411
search-filter	2307
secure cipher (ldap-server).....	2309
secure mode (ldap-server)	2311
secure trustpoint (ldap-server)	2313
security (wireless).....	2932

security (wireless-network).....	2934
security (wireless-wds).....	2935
security-password forced-change	225
security-password history.....	224
security-password lifetime	226
security-password minimum-categories.....	228
security-password minimum-length.....	229
security-password min-lifetime-enforce	227
security-password reject-expired-pwd.....	230
security-password warning	231
send-lifetime	990
server (ldap-group)	2314
server (pppoe-relay)	727
server (RADIUS server group).....	2334
server (radsecproxy-aaa)	2276
server auth-port	2374
server enable.....	2375
server mutual-authentication	2278
server name-check	2279
server trustpoint.....	2280
server-url (web-redirect)	269
service 2fa.....	2403
service advanced-vty	232
service atmf-application-proxy.....	2648
service dhcp-relay	3104
service dhcp-relay	3179
service dhcp-server.....	3105
service http.....	148
service password-encryption.....	233
service pim	1938
service pim6.....	1999
service snmp-discovery	3046
service ssh.....	3361
service statistics interfaces counter.....	452
service telnet.....	234

service url-offload	3604
service wireless	2936
service-name	728
session-keep	2937
session-key-refresh-action	2938
session-key-refresh-interval	2939
session-timeout-action (wireless network-cp)	2940
session-timeout-interval (wireless network-cp)	2941
set aggregator	1548
set as-path	1457
set as-path	1549
set atomic-aggregate	1550
set comm-list delete	1551
set community	1458
set community	1552
set dampening	1554
set extcommunity	1556
set ip next-hop (route map)	1558
set ipv6 next-hop	1559
set local-preference	1560
set metric	1561
set metric-type	1563
set origin	1564
set originator-id	1565
set tag	1566
set weight	1567
shared-secret	3751
short-lease-threshold	3106
show 2fa user	2406
show 2fa users	2408
show 2fa	2405
show aaa local user locked	2282
show aaa local user locked	235
show aaa server group	2283
show application detail	3519

show application	3518
show application-proxy threat-protection	2649
show application-proxy whitelist advertised-address	2651
show application-proxy whitelist interface	2652
show application-proxy whitelist server	2654
show application-proxy whitelist supplicant	2655
show arp	1673
show arp	786
show atmf area guests	2664
show atmf area guests-detail	2666
show atmf area nodes	2668
show atmf area nodes-detail	2670
show atmf area summary	2672
show atmf area	2661
show atmf authorization	2673
show atmf backup area	2680
show atmf backup guest	2682
show atmf backup	2676
show atmf container	2684
show atmf detail	2687
show atmf group members	2691
show atmf group	2689
show atmf guests detail	2695
show atmf guests	2693
show atmf links detail	2700
show atmf links guest detail	2711
show atmf links guest	2709
show atmf links statistics	2715
show atmf links	2698
show atmf nodes	2718
show atmf provision nodes	2720
show atmf recovery-file	2722
show atmf secure-mode audit link	2726
show atmf secure-mode audit	2725
show atmf secure-mode certificates	2727

show atmf secure-mode sa.....	2730
show atmf secure-mode statistics	2733
show atmf secure-mode	2723
show atmf tech	2735
show atmf virtual-links.....	2738
show atmf working-set	2740
show atmf.....	2657
show auth diagnostics	2216
show auth interface.....	2217
show auth sessionstatistics.....	2219
show auth statistics interface	2220
show auth supplicant interface.....	2224
show auth supplicant	2221
show auth two-step supplicant brief	2225
show auth.....	2215
show auth-web-server page	2228
show auth-web-server	2227
show autoboot	186
show banner external-manager	302
show banner login.....	3363
show bgp ipv6 (BGP4+ only)	1460
show bgp ipv6 community (BGP4+ only)	1461
show bgp ipv6 community-list (BGP4+ only).....	1463
show bgp ipv6 dampening (BGP4+ only)	1464
show bgp ipv6 filter-list (BGP4+ only)	1465
show bgp ipv6 inconsistent-as (BGP4+ only).....	1466
show bgp ipv6 longer-prefixes (BGP4+ only).....	1467
show bgp ipv6 neighbors (BGP4+ only)	1468
show bgp ipv6 paths (BGP4+ only)	1471
show bgp ipv6 prefix-list (BGP4+ only)	1472
show bgp ipv6 quote-regexp (BGP4+ only)	1473
show bgp ipv6 regexp (BGP4+ only).....	1474
show bgp ipv6 route-map (BGP4+ only)	1476
show bgp ipv6 summary (BGP4+ only)	1477
show bgp memory maxallocation (BGP only)	1478

show bgp nexthop-tracking (BGP only).....	1479
show bgp nexthop-tree-details (BGP only).....	1480
show boot.....	187
show bridge macaddr	547
show bridge.....	545
show cellular	470
show clock	303
show connection-log events	3483
show connection-log events	426
show counter dhcp-client.....	3108
show counter dhcp-relay	3109
show counter dhcp-relay	3180
show counter dhcp-server	3113
show counter ipv6 dhcp-client.....	3184
show counter ipv6 dhcp-server	3186
show counter log.....	427
show counter mail.....	3329
show counter ping-poll.....	3457
show counter snmp-server.....	3221
show cpu history	308
show cpu.....	305
show crypto key hostkey.....	3364
show crypto key mypubkey rsa.....	2429
show crypto key pubkey-chain knownhosts	1675
show crypto key pubkey-chain knownhosts	3366
show crypto key pubkey-chain userkey.....	3368
show crypto key userkey.....	3369
show crypto pki certificates	2430
show crypto pki enrollment user	2432
show crypto pki trustpoint.....	2433
show ddns-update-method status	846
show debugging 2fa.....	2409
show debugging aaa	2284
show debugging atmf packet	2742
show debugging atmf	2741

show debugging bgp (BGP only)	1481
show debugging dot1x	2089
show debugging firewall	3491
show debugging igmp	1822
show debugging ip dns forwarding	847
show debugging ip packet	788
show debugging ipv6 ospf	1198
show debugging ipv6 pim sparse-mode	2000
show debugging ipv6 rip	1025
show debugging isakmp	3649
show debugging l2tp	3752
show debugging lacp	649
show debugging linkmon	1766
show debugging lldp	3297
show debugging mld	1861
show debugging mstp	580
show debugging nsm mcast	1892
show debugging ospf	1104
show debugging pim sparse-mode	1939
show debugging platform packet	501
show debugging ppp	702
show debugging pppoe ac	730
show debugging radius	2336
show debugging rip	992
show debugging snmp	3225
show debugging traffic-control	2041
show debugging trigger	3413
show debugging vrrp	2474
show debugging wireless	2942
show debugging	310
show dhcp lease	3116
show diagnostic channel-group	650
show dot1x diagnostics	2093
show dot1x interface	2095
show dot1x sessionstatistics	2097

show dot1x statistics interface	2098
show dot1x supplicant interface	2101
show dot1x supplicant.....	2099
show dot1x.....	2090
show dpi statistics	3573
show dpi	3572
show entity.....	3521
show etherchannel detail	652
show etherchannel summary	653
show etherchannel	651
show exception log.....	428
show file systems	190
show file	189
show firewall connections limits config-check	3487
show firewall connections limits	3486
show firewall connections	3485
show firewall rule config-check	3490
show firewall rule.....	3488
show firewall	3484
show flowcontrol interface.....	502
show history.....	137
show hosts	848
show http client	150
show http client	1692
show http	149
show interface (PPP)	703
show interface brief.....	457
show interface err-disabled	503
show interface memory.....	311
show interface memory.....	458
show interface status	460
show interface switchport	504
show interface tunnel (GRE).....	3695
show interface tunnel (IPsec).....	3650
show interface tunnel (IPv6).....	3809

show interface tunnel (L2TPv3).....	3768
show interface tunnel (OpenVPN)	3717
show interface.....	453
show ip bgp (BGP only)	1482
show ip bgp attribute-info (BGP only)	1483
show ip bgp cidr-only (BGP only).....	1484
show ip bgp cidr-only (BGP only).....	1677
show ip bgp community (BGP only)	1485
show ip bgp community (BGP only)	1678
show ip bgp community-info (BGP only).....	1487
show ip bgp community-list (BGP only).....	1488
show ip bgp community-list (BGP only).....	1680
show ip bgp dampening (BGP only)	1489
show ip bgp dampening (BGP only)	1681
show ip bgp filter-list (BGP only)	1491
show ip bgp filter-list (BGP only)	1683
show ip bgp inconsistent-as (BGP only).....	1492
show ip bgp inconsistent-as (BGP only).....	1684
show ip bgp longer-prefixes (BGP only).....	1493
show ip bgp longer-prefixes (BGP only).....	1685
show ip bgp neighbors (BGP only)	1494
show ip bgp neighbors connection-retrytime (BGP only).....	1497
show ip bgp neighbors hold-time (BGP only)	1498
show ip bgp neighbors keepalive (BGP only)	1499
show ip bgp neighbors keepalive-interval (BGP only)	1500
show ip bgp neighbors notification (BGP only).....	1501
show ip bgp neighbors open (BGP only).....	1502
show ip bgp neighbors rcvd-msgs (BGP only).....	1503
show ip bgp neighbors sent-msgs (BGP only).....	1504
show ip bgp neighbors update (BGP only).....	1505
show ip bgp paths (BGP only)	1506
show ip bgp prefix-list (BGP only)	1507
show ip bgp prefix-list (BGP only)	1686
show ip bgp quote-regexp (BGP only)	1508
show ip bgp quote-regexp (BGP only)	1687

show ip bgp regexp (BGP only).....	1510
show ip bgp regexp (BGP only).....	1689
show ip bgp route-map (BGP only)	1512
show ip bgp route-map (BGP only)	1691
show ip bgp scan (BGP only)	1513
show ip bgp summary (BGP only)	1514
show ip bgp summary (BGP only)	1693
show ip community-list.....	1516
show ip dhcp binding.....	3117
show ip dhcp pool.....	3119
show ip dhcp server statistics	3126
show ip dhcp server summary	3129
show ip dhcp-relay	3124
show ip dhcp-relay	3188
show ip dns forwarding cache	850
show ip dns forwarding server	852
show ip dns forwarding.....	849
show ip domain-list.....	854
show ip domain-name.....	855
show ip extcommunity-list.....	1517
show ip flooding-next hops	789
show ip forwarding	790
show ip igmp groups	1823
show ip igmp interface	1825
show ip igmp proxy groups.....	1828
show ip igmp proxy.....	1827
show ip igmp snooping mrouter	1830
show ip igmp snooping routermode	1831
show ip igmp snooping source-timeout.....	1832
show ip igmp snooping statistics.....	1833
show ip interface vrf	1695
show ip interface vrf	792
show ip interface	791
show ip mroute.....	1893
show ip mvif.....	1896

show ip name-server.....	856
show ip ospf border-routers.....	1108
show ip ospf database asbr-summary	1111
show ip ospf database external	1112
show ip ospf database network	1114
show ip ospf database nssa-external	1115
show ip ospf database opaque-area.....	1117
show ip ospf database opaque-as	1118
show ip ospf database opaque-link.....	1119
show ip ospf database router	1120
show ip ospf database summary	1122
show ip ospf database	1109
show ip ospf interface	1125
show ip ospf neighbor	1126
show ip ospf route.....	1128
show ip ospf virtual-links.....	1129
show ip ospf.....	1105
show ip pbr route.....	1579
show ip pim sparse-mode bsr-router	1940
show ip pim sparse-mode interface detail	1943
show ip pim sparse-mode interface	1941
show ip pim sparse-mode local-members	1944
show ip pim sparse-mode mroute detail.....	1947
show ip pim sparse-mode mroute.....	1945
show ip pim sparse-mode neighbor.....	1949
show ip pim sparse-mode nexthop.....	1951
show ip pim sparse-mode packet statistics	1952
show ip pim sparse-mode rp mapping	1954
show ip pim sparse-mode rp-hash	1953
show ip prefix-list.....	1518
show ip prefix-list.....	993
show ip protocols bgp (BGP only)	1520
show ip protocols ospf.....	1130
show ip protocols rip	994
show ip rip database.....	996

show ip rip interface	997
show ip rip vrf database.....	1697
show ip rip vrf database.....	998
show ip rip vrf interface.....	1698
show ip rip vrf interface.....	999
show ip rip	995
show ip route database	1702
show ip route database	935
show ip route summary.....	1705
show ip route summary.....	938
show ip route.....	1699
show ip route.....	932
show ip rpf	1897
show ip sockets.....	794
show ip traffic	797
show ip vrf detail	1708
show ip vrf interface	1709
show ip vrf	1707
show ips categories.....	3552
show ips.....	3551
show ipsec counters	3652
show ipsec peer	3653
show ipsec policy.....	3654
show ipsec profile	3655
show ipsec sa.....	3657
show ipv6 dhcp binding	3191
show ipv6 dhcp interface	3194
show ipv6 dhcp pool	3196
show ipv6 dhcp	3190
show ipv6 forwarding.....	914
show ipv6 interface.....	915
show ipv6 mif	1898
show ipv6 mld groups	1862
show ipv6 mld interface	1863
show ipv6 mld snooping mrouter	1864

show ipv6 mld snooping statistics	1865
show ipv6 mroute	1899
show ipv6 multicast forwarding	1901
show ipv6 neighbors	917
show ipv6 ospf database external	1202
show ipv6 ospf database grace	1203
show ipv6 ospf database inter-prefix	1204
show ipv6 ospf database inter-router	1205
show ipv6 ospf database intra-prefix	1206
show ipv6 ospf database link	1207
show ipv6 ospf database network	1208
show ipv6 ospf database router	1210
show ipv6 ospf database	1201
show ipv6 ospf interface	1215
show ipv6 ospf neighbor	1216
show ipv6 ospf route	1217
show ipv6 ospf virtual-links	1218
show ipv6 ospf	1199
show ipv6 pbr route	1581
show ipv6 pim sparse-mode bsr-router	2001
show ipv6 pim sparse-mode interface detail	2004
show ipv6 pim sparse-mode interface	2002
show ipv6 pim sparse-mode local-members	2005
show ipv6 pim sparse-mode mroute detail	2008
show ipv6 pim sparse-mode mroute	2006
show ipv6 pim sparse-mode neighbor	2010
show ipv6 pim sparse-mode nexthop	2011
show ipv6 pim sparse-mode rp mapping	2013
show ipv6 pim sparse-mode rp nexthop	2014
show ipv6 pim sparse-mode rp-hash	2012
show ipv6 prefix-list	1026
show ipv6 prefix-list	1519
show ipv6 protocols rip	1027
show ipv6 rip database	1029
show ipv6 rip interface	1030

show ipv6 rip	1028
show ipv6 route summary	920
show ipv6 route summary	942
show ipv6 route	918
show ipv6 route	940
show isakmp counters	3658
show isakmp key (IPsec)	3659
show isakmp peer	3660
show isakmp profile	3661
show isakmp sa	3663
show l2tp session	3753
show l2tp tunnel config-check	3759
show l2tp tunnel	3755
show lacp sys-id	654
show lacp-counter	655
show ldap server group	2315
show linkmon probe	1767
show linkmon probe-history	1770
show lldp interface	3300
show lldp local-info	3302
show lldp neighbors detail	3308
show lldp neighbors	3307
show lldp statistics interface	3314
show lldp statistics	3312
show lldp	3298
show location	3316
show log config	431
show log external	433
show log permanent	434
show log	429
show mac address-table	505
show mac-filter	548
show mail	3330
show memory allocations	315
show memory history	317

show memory pools	318
show memory shared.....	319
show memory	313
show mirror interface.....	481
show mirror	480
show nat rule config-check	3543
show nat rule.....	3541
show nat	3540
show ntp associations	3212
show ntp counters associations	3215
show ntp counters.....	3214
show ntp status	3216
show openvpn connections detail.....	3719
show openvpn connections.....	3718
show pbr rules brief	1588
show pbr rules brief	1777
show pbr rules.....	1583
show pbr rules.....	1772
show ping-poll	3459
show platform port.....	509
show platform.....	507
show port etherchannel	656
show pppoe-ac config-check.....	731
show pppoe-ac connections	733
show pppoe-ac statistics.....	735
show privilege.....	236
show process.....	320
show proxy-autoconfig-file	2229
show radius dynamic-authorization counters.....	2340
show radius local-server group.....	2376
show radius local-server nas	2377
show radius local-server statistics	2378
show radius local-server user.....	2379
show radius server group	2285
show radius	2337

show reboot history	322
show resource	248
show rmon alarm	3339
show rmon event	3340
show rmon history	3342
show rmon statistics	3344
show route-map	1521
show route-map	1568
show router-id	323
show running-config atmf	2743
show running-config dpi	3575
show running-config firewall	3492
show running-config interface	195
show running-config ips	3554
show running-config l2tp-profile	3761
show running-config l2tp-tunnel	3762
show running-config log	435
show running-config nat	3544
show running-config pppoe-ac	738
show running-config pppoe-relay	739
show running-config router ipv6 vrrp	2475
show running-config router vrrp	2476
show running-config snmp	3226
show running-config snmp-discovery	3047
show running-config software-configuration	3786
show running-config ssh	3370
show running-config traffic-control	2042
show running-config trigger	3414
show running-config url-filter	3560
show running-config url-offload	3605
show running-config vrf	1713
show running-config web-redirect	270
show running-config	192
show security-password configuration	237
show security-password user	238

show snmp-discovery.....	3048
show snmp-server community	3228
show snmp-server group	3229
show snmp-server trap	3230
show snmp-server user	3231
show snmp-server view.....	3232
show snmp-server	3227
show software-configuration	3787
show spanning-tree brief	584
show spanning-tree mst config	586
show spanning-tree mst detail interface.....	589
show spanning-tree mst detail	587
show spanning-tree mst instance interface	592
show spanning-tree mst instance	591
show spanning-tree mst interface	593
show spanning-tree mst	585
show spanning-tree statistics instance interface	597
show spanning-tree statistics instance	596
show spanning-tree statistics interface	599
show spanning-tree statistics	594
show spanning-tree vlan range-index	601
show spanning-tree	581
show ssh client	3374
show ssh server allow-users.....	3377
show ssh server deny-users	3378
show ssh server.....	3375
show ssh	3372
show startup-config	198
show static-channel-group.....	657
show storm-control.....	511
show system environment counters.....	326
show system environment.....	325
show system interrupts	328
show system mac.....	329
show system pci device.....	330

show system pci tree	331
show system serialnumber.....	332
show system usb	473
show system	324
show tacacs+.....	2443
show tech-support	333
show telnet.....	239
show traffic-control counters.....	2044
show traffic-control interface	2046
show traffic-control policy	2048
show traffic-control red-curve.....	2050
show traffic-control rule config-check	2052
show traffic-control rule	2053
show traffic-control.....	2054
show trigger.....	3415
show tunnel inline-processing counters	3664
show url-filter	3561
show url-offload endpoint-source manual entries.....	3607
show url-offload endpoint-source office365 entries.....	3609
show url-offload endpoint-source office365 raw-data.....	3612
show url-offload endpoint-source	3606
show url-offload pac-file template.....	3619
show url-offload pac-file	3615
show users	240
show version	199
show vlan	551
show vrrp (session)	2483
show vrrp counters	2479
show vrrp ipv6.....	2482
show vrrp	2477
show web-redirect.....	271
show wireless ap capability	2951
show wireless ap client	2953
show wireless ap neighbors.....	2954
show wireless ap power-channel.....	2955

show wireless ap	2944
show wireless ap-profile	2956
show wireless auto-config	2960
show wireless captive-portal network walled-garden	2963
show wireless country-code.....	2964
show wireless network.....	2965
show wireless power-channel calculate	2970
show wireless sc-profile.....	2971
show wireless security	2973
show wireless smart-connect ap	2975
show wireless task.....	2976
show wireless wds.....	2979
show wireless wireless-mac-filter.....	2981
show wireless wireless-trigger	2983
show wireless	2943
shutdown	462
size (linkmon-probe).....	1779
smart-connect-profile.....	2984
snmp (wireless-ap-prof).....	2985
snmp trap link-status suppress	3235
snmp trap link-status	3233
snmp-discovery arp-polling-interval.....	3051
snmp-discovery community	3052
snmp-discovery deny.....	3053
snmp-discovery permit	3055
snmp-discovery snmp-polling-interval	3056
snmp-discovery snmp-version	3057
snmp-discovery user.....	3058
snmp-server community	3239
snmp-server contact.....	3240
snmp-server enable trap	3241
snmp-server engineID local reset.....	3246
snmp-server engineID local	3244
snmp-server group	3247
snmp-server host.....	1710

snmp-server host	3249
snmp-server legacy-ifadminstatus	3252
snmp-server location	3253
snmp-server source-interface	3254
snmp-server startup-trap-delay	3255
snmp-server user	3256
snmp-server view	3259
snmp-server	3237
sntp-address	3198
software-configuration	3789
source (linkmon-probe)	1780
source	3763
source-ip	3463
spanning-tree autoedge (RSTP and MSTP)	602
spanning-tree cisco-interoperability (MSTP)	603
spanning-tree edgeport (RSTP and MSTP)	604
spanning-tree enable	605
spanning-tree errdisable-timeout enable	607
spanning-tree errdisable-timeout interval	608
spanning-tree force-version	609
spanning-tree forward-time	610
spanning-tree guard root	611
spanning-tree hello-time	612
spanning-tree link-type	613
spanning-tree max-age	614
spanning-tree max-hops (MSTP)	615
spanning-tree mode	616
spanning-tree mst configuration	617
spanning-tree mst instance path-cost	619
spanning-tree mst instance priority	621
spanning-tree mst instance restricted-role	622
spanning-tree mst instance restricted-tcn	624
spanning-tree mst instance	618
spanning-tree path-cost	625
spanning-tree portfast (STP)	626

spanning-tree portfast bpdu-filter	628
spanning-tree portfast bpdu-guard	630
spanning-tree priority (bridge priority)	632
spanning-tree priority (port priority).....	633
spanning-tree restricted-role.....	634
spanning-tree restricted-tcn	635
spanning-tree transmit-holdcount	636
speed (asyn).....	335
speed	512
sport	3524
ssh client	1716
ssh client	3381
ssh server allow-users.....	3386
ssh server authentication	3388
ssh server deny-users	3390
ssh server max-auth-tries	3392
ssh server resolve-host.....	3393
ssh server scp.....	3394
ssh server secure-algs.....	3395
ssh server secure-ciphers	3396
ssh server secure-kex	3397
ssh server secure-mac	3398
ssh server sftp	3399
ssh server tcpforwarding.....	3400
ssh server vrf	1718
ssh server vrf	3385
ssh server	3383
ssh	1714
ssh	3379
ssid (wireless-network).....	2986
ssid (wireless-sc-prof)	2987
state	2744
static-channel-group	658
station-isolation enable (wireless-ap-prof-radio)	2988
storm-control level	514

sub-class (htb)	2055
sub-class (priority)	2057
sub-class (wrr)	2059
subject-name (ca-trustpoint)	2434
subnet-mask	3130
sub-sub-class (htb)	2061
sub-sub-class (priority)	2063
sub-sub-class (wrr)	2065
summary-address (IPv6 OSPF)	1219
summary-address	1131
suppress-ipv4-updates	858
switchport access vlan	552
switchport atmf-agentlink	2746
switchport atmf-arealink	2747
switchport atmf-crosslink	2749
switchport atmf-guestlink	2751
switchport atmf-link	2753
switchport mode access	553
switchport mode trunk	554
switchport trunk allowed vlan	555
switchport trunk native vlan	558
switchport voice dscp	559
switchport voice vlan priority	562
switchport voice vlan	560
synchronization	1522
tacacs-server host	1719
tacacs-server host	2445
tacacs-server key	2447
tacacs-server timeout	2448
task	2989
tcpdump	1721
tcpdump	799
telnet server	242
telnet	1722
telnet	241

terminal length.....	243
terminal monitor	337
terminal resize.....	244
test	3420
time (trigger)	3421
time (wireless-task)	2990
timeout (ldap-server)	2317
timeout (ping polling)	3465
timeout (pppoe-relay)	740
timers (BGP)	1524
timers (IPv6 RIPng).....	1031
timers (RIP)	1000
timers (RIP)	1723
timers spf exp (IPv6 OSPF)	1221
timers spf exp	1132
traceroute ipv6	921
traceroute.....	1725
traceroute.....	800
traffic-control enable	2067
traffic-control.....	2068
transform (IPsec Profile).....	3666
transform (ISAKMP Profile)	3667
transition-mode	2485
trap host (wireless-ap-prof-snmp)	2991
trap	3423
trigger activate	3425
trigger	3424
tunnel checksum	3696
tunnel destination (DS-Lite).....	3791
tunnel destination (GRE)	3698
tunnel destination (IPsec)	3669
tunnel destination (IPv6).....	3810
tunnel destination (L2TPv3).....	3769
tunnel df	3771
tunnel dscp	3697

tunnel dscp	3812
tunnel endpoint	3700
tunnel inline-processing	3671
tunnel local id	3772
tunnel local name (GRE).....	3702
tunnel local name (IPsec)	3672
tunnel local selector	3673
tunnel mode (IPv6)	3813
tunnel mode ds-lite.....	3792
tunnel mode gre multipoint	3704
tunnel mode gre.....	3703
tunnel mode ipsec.....	3675
tunnel mode l2tp v3	3773
tunnel mode lw4o6.....	3793
tunnel mode map-e	3794
tunnel mode openvpn tap	3724
tunnel mode openvpn tun.....	3725
tunnel openvpn authentication	3721
tunnel openvpn cipher	3722
tunnel openvpn expiry-bytes	3726
tunnel openvpn expiry-seconds.....	3727
tunnel openvpn port	3728
tunnel openvpn tagging.....	3729
tunnel openvpn tls-crypt.....	3730
tunnel openvpn tls-version-min.....	3720
tunnel oper-status-control	3676
tunnel protection ipsec (GRE)	3705
tunnel protection ipsec (IPsec)	3679
tunnel protection ipsec	3774
tunnel remote id.....	3775
tunnel remote name (GRE)	3706
tunnel remote name (IPsec).....	3680
tunnel remote selector.....	3681
tunnel security-reprocessing	3683
tunnel security-reprocessing	3707

tunnel security-reprocessing	3731
tunnel security-reprocessing	3776
tunnel security-reprocessing	3790
tunnel selector paired	3684
tunnel software	3795
tunnel source (GRE).....	3708
tunnel source (IPsec).....	3685
tunnel source (IPv6).....	3814
tunnel source (L2TPv3).....	3777
tunnel ttl	3710
tunnel ttl	3816
type (wireless-sec-wep).....	2992
type ap-configuration apply ap	2993
type atmf guest.....	2754
type atmf guest.....	3426
type atmf node	2755
type atmf node	3427
type cpu	3429
type download ap (wireless-task).....	2994
type env-sensor	3430
type interface	3432
type linkmon-probe	3433
type log	3435
type memory.....	3436
type periodic	3437
type ping-poll	3438
type power-channel ap all	2995
type reboot	3439
type time.....	3440
type usb.....	3441
unauth-emergency-service-access enable	
(wireless-network-passpoint-dot11u)	2996
undebg aaa	2287
undebg all ipv6 pim sparse-mode.....	2016
undebg all pim sparse-mode	1955

undebg all	338
undebg atmf	2757
undebg bgp (BGP only)	1526
undebg ddns	859
undebg dot1x	2103
undebg igmp	1835
undebg ip packet interface	801
undebg ipv6 ospf events	1222
undebg ipv6 ospf ifsm	1223
undebg ipv6 ospf lsa	1224
undebg ipv6 ospf nfsm	1225
undebg ipv6 ospf packet	1226
undebg ipv6 ospf route	1227
undebg ipv6 pim sparse-mode	2017
undebg ipv6 rip	1032
undebg isakmp	3687
undebg lacp	660
undebg mail	3331
undebg mstp	637
undebg ospf events	1133
undebg ospf ifsm	1134
undebg ospf lsa	1135
undebg ospf nfsm	1136
undebg ospf nsm	1137
undebg ospf packet	1138
undebg ospf route	1139
undebg ping-poll	3467
undebg platform packet	515
undebg ppp	707
undebg radius	2342
undebg rip	1002
undebg snmp	3260
undebg ssh client	3401
undebg ssh server	3402
undebg trigger	3442

undebbug vrrp events	2488
undebbug vrrp packet	2489
undebbug vrrp	2487
unmount.....	200
unmount.....	436
up-count	3466
update now	249
update webgui now	151
update webgui now	250
update-interval (ddns-update-method)	860
update-interval (endpoint-office365).....	3621
update-url (ddns-update-method)	861
upstream-interface	3796
url (endpoint office365).....	3622
url (linkmon-probe).....	1781
url-filter reload custom-lists.....	3562
url-filter	3563
url-offload update-now.....	3624
url-offload.....	3623
usb mode-switch	475
use-ipv4-for-ipv6-updates	864
user (radsrv)	2381
username (atmf-guest).....	2758
username (ddns-update-method)	865
username (wireless-ap-prof-snmp)	2997
username	245
vap (wireless-ap-prof-radio).....	2999
venue group (wireless-network-passpoint-dot11u)	3000
venue name (wireless-network-passpoint-dot11u).....	3001
venue type (wireless-network-passpoint-dot11u).....	3002
version (ISAKMP)	3688
version (RIP)	1003
version (RIP)	1726
version (wireless-ap-prof-snmp).....	3003
version	3764

versions (wireless-sec-osen).....	3004
versions (wireless-sec-wpa-ent)	3005
versions (wireless-sec-wpa-psnl)	3006
virtual-ip	2490
virtual-ipv6	2492
vlan (radsrv-grp)	2383
vlan (wireless-network)	3007
vlan database	565
vlan	563
vrf.....	1728
vrf.....	3131
vrrp vmac	2494
wait	440
walled-garden entry	3008
wan-bypass (interface mode)	2453
wan-metrics downlink-load (wireless-network-passpoint-hs20)	3010
wan-metrics downlink-speed (wireless-network-passpoint-hs20).....	3011
wan-metrics info (wireless-network-passpoint-hs20).....	3012
wan-metrics load-measure-duration (wireless-network-passpoint-hs20)..	3014
wan-metrics uplink-load (wireless-network-passpoint-hs20)	3015
wan-metrics uplink-speed (wireless-network-passpoint-hs20).....	3016
wds radio (wireless-ap)	3018
wds	3017
web-auth radius auth group	3019
web-categorization.....	3576
web-redirect	272
whitelist (url-filter).....	3564
wireless ap-configuration apply ap	3021
wireless auto-config	3022
wireless download ap url	3024
wireless emergency-mode usb mark key	3027
wireless emergency-mode	3026
wireless export	3029
wireless get-tech abort	3030
wireless get-tech ap	3031

wireless get-tech ap-profile	3032
wireless get-tech sc-profile.....	3033
wireless import	3034
wireless power-channel ap all	3035
wireless reset ap	3036
wireless wireless-trigger	3041
wireless	3020
wireless-mac-filter (wireless)	3037
wireless-mac-filter (wireless-ap-prof)	3038
wireless-mac-filter enable.....	3040
wireless-trigger	3042
wireless-trigger-id	3043
write file.....	201
write memory	202
write terminal	203
zone	3526

Part 1: Setup and Troubleshooting

1

CLI Navigation Commands

Introduction

Overview This chapter provides an alphabetical reference for the commands used to navigate between different modes. This chapter also provides a reference for the help and show commands used to help navigate within the CLI.

- Command List**
- [“configure terminal”](#) on page 128
 - [“disable \(Privileged Exec mode\)”](#) on page 129
 - [“do”](#) on page 130
 - [“enable \(Privileged Exec mode\)”](#) on page 131
 - [“end”](#) on page 133
 - [“exit”](#) on page 134
 - [“help”](#) on page 135
 - [“logout”](#) on page 136
 - [“show history”](#) on page 137

configure terminal

Overview This command enters the Global Configuration command mode.

Syntax `configure terminal`

Mode Privileged Exec

Example To enter the Global Configuration command mode (note the change in the command prompt), enter the command:

```
awplus# configure terminal
awplus(config)#
```

disable (Privileged Exec mode)

Overview This command exits the Privileged Exec mode, returning the prompt to the User Exec mode. To end a session, use the [exit](#) command.

Syntax `disable`

Mode Privileged Exec

Example To exit the Privileged Exec mode, enter the command:

```
awplus# disable
awplus>
```

Related commands

- [enable \(Privileged Exec mode\)](#)
- [end](#)
- [exit](#)

do

Overview This command lets you to run User Exec and Privileged Exec mode commands when you are in any configuration mode.

Syntax `do <command>`

Parameter	Description
<code><command></code>	Specify the command and its parameters.

Mode Any configuration mode

Example
`awplus# configure terminal`
`awplus(config)# do ping 192.0.2.23`

enable (Privileged Exec mode)

Overview This command enters the Privileged Exec mode and optionally changes the privilege level for a session. If a privilege level is not specified then the maximum privilege level (15) is applied to the session. If the optional privilege level is omitted then only users with the maximum privilege level can access Privileged Exec mode without providing the password as specified by the [enable password](#) or [enable secret \(deprecated\)](#) commands. If no password is specified then only users with the maximum privilege level set with the [username](#) command can access Privileged Exec mode.

Syntax `enable [<privilege-level>]`

Parameter	Description
<code><privilege - level></code>	Specify the privilege level for a CLI session in the range <1-15>, where 15 is the maximum privilege level, 7 is the intermediate privilege level and 1 is the minimum privilege level. The privilege level for a user must match or exceed the privilege level set for the CLI session for the user to access Privileged Exec mode. Privilege level for a user is configured by username .

Mode User Exec

Usage notes Many commands are available from the Privileged Exec mode that configure operating parameters for the device, so you should apply password protection to the Privileged Exec mode to prevent unauthorized use. Passwords can be encrypted but then cannot be recovered. Note that non-encrypted passwords are shown in plain text in configurations.

The [username](#) command sets the privilege level for the user. After login, users are given access to privilege level 1. Users access higher privilege levels with the [enable \(Privileged Exec mode\)](#) command. If the privilege level specified is higher than the users configured privilege level specified by the [username](#) command, then the user is prompted for the password for that level.

Note that a separate password can be configured for each privilege level using the [enable password](#) and the [enable secret \(deprecated\)](#) commands from the Global Configuration mode. The [service password-encryption](#) command encrypts passwords configured by the [enable password](#) and the [enable secret \(deprecated\)](#) commands, so passwords are not shown in plain text in configurations.

Example The following example shows the use of the **enable** command to enter the Privileged Exec mode (note the change in the command prompt).

```
awplus> enable  
awplus#
```

The following example shows the **enable** command enabling access the Privileged Exec mode for users with a privilege level of 7 or greater. Users with a privilege level of 7 or greater do not need to enter a password to access Privileged

Exec mode. Users with a privilege level 6 or less need to enter a password to access Privilege Exec mode. Use the [enable password](#) command or the [enable secret \(deprecated\)](#) commands to set the password to enable access to Privileged Exec mode.

```
awplus> enable 7  
awplus#
```

**Related
commands**

[disable \(Privileged Exec mode\)](#)
[enable password](#)
[enable secret \(deprecated\)](#)
[exit](#)
[service password-encryption](#)
[username](#)

end

Overview This command returns the prompt to the Privileged Exec command mode, from any advanced command mode.

Syntax end

Mode All advanced command modes, including Global Configuration and Interface Configuration modes.

Example The following example shows how to use the **end** command to return to the Privileged Exec mode directly from Interface Configuration mode.

```
awplus# configure terminal
awplus(config)# interface eth1
awplus(config-if)# end
awplus#
```

Related commands

- disable (Privileged Exec mode)
- enable (Privileged Exec mode)
- exit

exit

Overview This command exits the current mode, and returns the prompt to the mode at the previous level. When used in User Exec mode, the **exit** command terminates the session.

Syntax `exit`

Mode All command modes, including Interface Configuration and Global Configuration modes.

Example The following example shows the use of the **exit** command to exit Interface Configuration mode and return to Global Configuration mode.

```
awplus# configure terminal
awplus(config)# interface eth1
awplus(config-if)# exit
awplus(config)#
```

Related commands

- [disable \(Privileged Exec mode\)](#)
- [enable \(Privileged Exec mode\)](#)
- [end](#)

help

Overview This command displays a description of the AlliedWare Plus™ OS help system.

Syntax help

Mode All command modes

Example To display a description on how to use the system help, use the command:

```
awplus# help
```

Output Figure 1-1: Example output from the **help** command

```
When you need help at the command line, press '?'.

If nothing matches, the help list will be empty. Delete
characters until entering a '?' shows the available options.

Enter '?' after a complete parameter to show remaining valid
command parameters (e.g. 'show ?').

Enter '?' after part of a parameter to show parameters that
complete the typed letters (e.g. 'show ip?').
```

logout

Overview This command exits the User Exec or Privileged Exec modes and ends the session.

Syntax `logout`

Mode User Exec and Privileged Exec

Example To exit the User Exec mode, use the command:

```
awplus# logout
```

show history

Overview This command lists the commands entered in the current session. The history buffer is cleared automatically upon reboot.

The output lists all command line entries, including commands that returned an error.

For information on filtering and saving command output, see the [“Getting Started with AlliedWare Plus” Feature Overview and Configuration Guide](#).

Syntax `show history`

Mode User Exec and Privileged Exec

Example To display the commands entered during the current session, use the command:

```
awplus# show history
```

Output Figure 1-2: Example output from the **show history** command

```
1 en
2 show ru
3 conf t
4 route-map er deny 3
5 exit
6 ex
7 di
```

2

Device GUI and Vista Manager EX Commands

Introduction

Overview This chapter provides an alphabetical reference of commands used to configure the Device GUI. They also allow your device to be monitored and managed by Vista Manager EX™.

For more information, see [Getting Started with the Device GUI on VPN Routers](#).

- Command List**
- [“atmf topology-gui enable”](#) on page 139
 - [“http log webapi-requests”](#) on page 140
 - [“http client vrf”](#) on page 141
 - [“http vrf”](#) on page 142
 - [“http port”](#) on page 143
 - [“http secure-port”](#) on page 144
 - [“http trustpoint”](#) on page 145
 - [“log event-host”](#) on page 147
 - [“service http”](#) on page 148
 - [“show http”](#) on page 149
 - [“show http client”](#) on page 150
 - [“update webgui now”](#) on page 151

atmf topology-gui enable

Overview Use this command to enable the operation of Vista Manager EX on the Master device.

Vista Manager EX delivers state-of-the-art monitoring and management for your Autonomous Management Framework™ (AMF) network, by automatically creating a complete topology map of switches, firewalls and wireless access points (APs). An expanded view includes third-party devices such as security cameras.

Use the **no** variant of this command to disable operation of Vista Manager EX.

Syntax atmf topology-gui enable
no atmf topology-gui enable

Default Disabled by default on AMF Master and member nodes. Enabled by default on Controllers.

Mode Global Configuration mode

Usage notes To use Vista Manager EX, you must also enable the HTTP service on all AMF nodes, including all AMF masters and controllers. The HTTP service is enabled by default on AlliedWare Plus switches and disabled by default on AR-Series firewalls. To enable it, use the commands:

```
Node1# configure terminal
Node1(config)# service http
```

On one master in each AMF area in your network, you also need to configure the master to send event notifications to Vista Manager EX. To do this, use the commands:

```
Node1# configure terminal
Node1(config)# log event-host <ip-address> atmf-topology-event
```

Examples To enable Vista Manager EX on Node1, use the commands:

```
Node1# configure terminal
Node1(config)# atmf topology-gui enable
```

To disable Vista Manager EX on Node1, use the commands:

```
Node1# configure terminal
Node1(config)# no atmf topology-gui enable
```

Related commands [atmf enable](#)
[log event-host](#)
[service http](#)

http log webapi-requests

Overview Use this command to log authenticated web API requests. These logs allow you to monitor and debug Vista Manager EX or Device GUI interactions with your device.

See the [Logging Feature Overview and Configuration Guide](#) for more information about the different types of logging and how to filter log messages.

Use the **no** variant of this command to disable authenticated web API request logging.

Syntax `http log webapi-requests {configuration|all}`
`no http log webapi-requests`

Parameter	Description
configuration	Log PUT, POST, and DELETE requests.
all	Log PUT, POST, DELETE, and GET requests.

Default Web API request logging is disabled.

Mode Global Configuration

Example To enable logging of all authenticated web API requests, use the following commands:

```
awplus# configure terminal  
awplus(config)# http log webapi-requests all
```

To disable logging of authenticated web API requests, use the following commands:

```
awplus# configure terminal  
awplus(config)# no http log webapi-requests
```

Related commands [http port](#)
[service http](#)
[show log](#)

Command changes Version 5.4.8-1.1: command added

http client vrf

Overview Use this command to enable the use of a specific VRF for the command **copy http**. Use the **no** variant of this command to disable the configured VRF.

Syntax `http client vrf <vrf-name>`
`no http client vrf`

Parameter	Description
<code>vrf</code> <code><vrf-name></code>	Specify the VRF to use when copying a file using HTTP.

Default Global VRF.

Mode Privileged Exec

Examples To enable the use of VRF 'MyVRF', use the commands:

```
awplus# configure terminal  
awplus(config)# http client vrf MyVRF
```

To remove a specified VRF and revert to the global VRF, use the commands:

```
awplus# configure terminal  
awplus(config)# no http client vrf
```

Output Figure 2-1: Example output if the specified VRF does not exist:

```
"Invalid VRF instance MyVRF"
```

Related commands [copy \(filename\)](#)
[show http client](#)

Command changes Version 5.5.2-1.1: command added

http vrf

Overview Use this command to configure an HTTP server to be run within a specified VRF. Use the **no** variant of this command to remove a VRF configuration from the HTTP server.

Syntax `http vrf <vrf-name>`
`no http vrf`

Parameter	Description
<code>vrf</code>	Specify the VRF to use when running the HTTP server.
<code><vrf-name></code>	The name of the VRF instance.

Default By default the HTTP server uses the global VRF.

Mode Global Configuration

Examples To configure VRF 'MyVRF', use the commands:

```
awplus# configure terminal
awplus(config)# http vrf MyVRF
```

To return the HTTP server to the global VRF, use the commands:

```
awplus# configure terminal
awplus(config)# no http vrf
```

Related commands [service http](#)
[show http](#)

Command changes Version 5.5.2-1.1: command added

http port

Overview Use this command to change the HTTP port used to access the web-based device GUI, or to disable HTTP management.

Use the **no** variant of this command to return to using the default port, which is 80.

Syntax `http port {<1-65535>|none}`
`no http port`

Parameter	Description
<1-65535>	The HTTP port number
none	Disable HTTP management. You may want to do this if you need to use port 80 for a different service or you do not need to use HTTP at all.

Default The default port for accessing the GUI is port 80.

Mode Global Configuration

Usage notes Do not configure the HTTP port to be the same as the HTTPS port.
Note that the device will redirect from HTTP to HTTPS unless you have disabled HTTPS access, which we do not recommend doing.

Example To set the port to 8080, use the commands:

```
awplus# configure terminal  
awplus(config)# http port 8080
```

To return to using the default port of 80, use the commands:

```
awplus# configure terminal  
awplus(config)# no http port
```

To stop users from accessing the GUI via HTTP, use the commands:

```
awplus# configure terminal  
awplus(config)# http port none
```

Related commands [http secure-port](#)
[service http](#)
[show http](#)

Command changes Version 5.4.7-2.4: command added on AR-Series devices
Version 5.4.8-0.2: command added on AlliedWare Plus switches

http secure-port

Overview Use this command to change the HTTPS port used to access the web-based device GUI, or to disable HTTPS management.

Use the **no** variant of this command to return to using the default port, which is 443.

Syntax `http secure-port {<1-65535>|none}`
`no http secure-port`

Parameter	Description
<1-65535>	The HTTPS port number
none	Disable HTTPS management. Do not do this if you want to use Vista Manager EX or the GUI.

Default The default port for accessing the GUI is port 443.

Mode Global Configuration

Usage notes Do not configure the HTTPS port to be the same as the HTTP port.

Note that if you are using Vista Manager EX and need to change the HTTPS port, you must use certificate-based authorization in Vista Manager EX. See the [Vista Manager EX Installation Guide](#) for instructions.

Example To set the port to 8443, use the commands:

```
awplus# configure terminal
awplus(config)# http secure-port 8443
```

To return to using the default port of 443, use the commands:

```
awplus# configure terminal
awplus(config)# no http secure-port
```

To stop users from accessing the GUI via HTTPS, use the commands:

```
awplus# configure terminal
awplus(config)# http secure-port none
```

Related commands [http port](#)
[service http](#)
[show http](#)

Command changes Version 5.4.7-1.1: command added on AR-Series devices
Version 5.4.7-2.4: **none** parameter added

Version 5.4.8-0.2: command added on AlliedWare Plus switches

http trustpoint

Overview Use this command to set the PKI trustpoint to use for secure HTTP communication to an AlliedWare Plus device.

Use the **no** variant of this command to revert to using the default trustpoint 'default-selfsigned'.

Syntax `http trustpoint <trustpoint-name>`
`no http trustpoint`

Parameter	Description
<code><trustpoint-name></code>	Name of trustpoint

Default By default, HTTP uses the 'default-selfsigned' trustpoint.

Mode Global Configuration

Usage notes Before using the **http trustpoint** command you will need to establish a trustpoint. For example, you can create a local self-signed trustpoint using the procedure outlined below.

Create a self-signed trustpoint called 'vista' with keypair 'vista_key':

```
awplus# configure terminal
awplus(config)# crypto pki trustpoint vista
awplus(ca-trustpoint)# enrollment selfsigned
awplus(ca-trustpoint)# rsakeypair vista_key
awplus(ca-trustpoint)# exit
awplus(config)# exit
```

Create the root and server certificates for this trustpoint:

```
awplus# crypto pki authenticate vista
awplus# crypto pki enroll vista
```

For more information about the AlliedWare Plus implementation of Public Key Infrastructure (PKI), see the [Public Key Infrastructure \(PKI\) Feature Overview and Configuration Guide](#)

Example To configure HTTP to use the trustpoint 'vista', use the commands:

```
awplus# configure terminal
awplus(config)# http trustpoint vista
```

To configure HTTP to use the default trustpoint 'default-selfsigned', use the commands:

```
awplus# configure terminal  
awplus(config)# no http trustpoint
```

**Related
commands**

[crypto pki trustpoint](#)
[show crypto pki certificates](#)
[show crypto pki trustpoint](#)

**Command
changes**

Version 5.5.1-2.1: command added

log event-host

Overview Use this command to set up an external host to log AMF topology events through Vista Manager. This command is run on the Master device.

Use the **no** variant of this command to disable log events through Vista Manager.

Syntax `log event-host [<ipv4-addr>|<ipv6-addr>] atmf-topology-event`
`no log event-host [<ipv4-addr>|<ipv6-addr>] atmf-topology-event`

Parameter	Description
<code><ipv4-addr></code>	ipv4 address of the event host
<code><ipv6-addr></code>	ipv6 address of the event host

Default Log events are disabled by default.

Mode Global Configuration

Usage notes Event hosts are set so syslog sends the messages out as they come.

Note that there is a difference between log event and log host messages:

- Log event messages are sent out as they come by syslog
- Log host messages are set to wait for a number of messages (20) to send them out together for traffic optimization.

Example To enable Node 1 to log event messages from host IP address 192.0.2.31, use the following commands:

```
Node1# configure terminal
```

```
Node1(config)# log event-host 192.0.2.31 atmf-topology-event
```

To disable Node 1 to log event messages from host IP address 192.0.2.31, use the following commands:

```
Node1# configure terminal
```

```
Node1(config)# no log event-host 192.0.2.31 atmf-topology-event
```

Related commands [atmf topology-gui enable](#)

service http

Overview Use this command to enable the HTTP (Hypertext Transfer Protocol) service. This service is required to support Vista Manager EX™ and the Device GUI. Use the **no** variant of this command to disable the HTTP feature.

Syntax `service http`
`no service http`

Default Enabled if your device came from the factory with the Device GUI pre-installed. Otherwise disabled.

Mode Global Configuration

Example To enable the HTTP service, use the following commands:

```
awplus# configure terminal  
awplus(config)# service http
```

To disable the HTTP service, use the following commands:

```
awplus# configure terminal  
awplus(config)# no service http
```

Related commands [http port](#)
[http secure-port](#)
[show http](#)

show http

Overview This command shows the HTTP server settings.

Syntax show http

Mode User Exec and Privileged Exec

Example To show the HTTP server settings, use the command:

```
awplus# show http
```

Output Figure 2-2: Example output from the **show http** command

```
awplus#show http
HTTP Server Configuration
-----
HTTP server           : Enabled
Port                  : 80
Secure Port           : 443

Web GUI Information
-----
GUI file in use       : awplus-gui_551_23.gui

Server Certificate
-----
Subject       : O = Allied-Telesis, CN = AlliedwarePlusCA
Issuer        : O = Allied-Telesis, CN = AlliedwarePlusCA
Valid From    : Jun  1 23:26:03 2021 GMT
Valid To      : May 30 23:26:03 2031 GMT
Fingerprints  :
  SHA-1       : 08:17:88:8C:5D:B0:D4:39:3C:8E:B6:EC:B6:BE:42:FF:57:EA:42:CC
  SHA-256     : D7:4E:D4:29:E2:DD:D0:08:F7:B1:4E:4F:47:89:09:13:47:93:B3:64:79:CC:62:E7:
  FE:A6:D8:5D:9A:9C:E5:F0
```

Related commands [clear line vty](#)
[service http](#)

show http client

Overview Use this command to show the current HTTP client VRF.

Syntax `show http client`

Mode Privileged Exec

Usage notes If no VRF has been set, the show command shows 'None'.

Example To display the HTTP client VRF, use the commands:

```
awplus# show http client
```

Output Figure 2-3: Example output from **show http client**

```
awplus#show http client
Hyper-Text Transfer Protocol Client Configuration
-----
VRF                                     : MyVRFPoE
```

Related commands [copy \(filename\)](#)

Command changes Version 5.5.2-1.1: command added

update webgui now

Overview Use this command to check whether you have the latest version of the device's GUI and update it if a newer version is available.

Syntax `update webgui now`

Mode Privileged Exec

Usage notes If you have previously used the **copy** command to copy GUI files onto your device, these files need to be deleted before running **update webgui now**. To delete all GUI files, use the command:

```
awplus# del *gui_*.tar.gz
```

Examples To check for GUI updates, use the following command:

```
awplus# update webgui now
```

Related commands [show resource](#)

Command changes Version 5.4.9-2.1: command added to SBx908 GEN2

3

File and Configuration Management Commands

Introduction

Overview This chapter provides an alphabetical reference of AlliedWare Plus™ OS file and configuration management commands.

Filename Syntax and Keyword Usage Many of the commands in this chapter use the placeholder 'filename' to represent the name and location of the file that you want to act on. The following table explains the syntax of the filename for each different type of file location.

When you copy a file...	Use this syntax:	Example:
Copying in local flash memory	<code>flash: [/] [<directory>/] <filename></code>	To specify a file in the configs directory in flash: <code>flash:configs/example.cfg</code>
Copying to or from a USB storage device	<code>usb: [/] [<directory>/] <filename></code>	To specify a file in the top-level directory of the USB stick: <code>usb:example.cfg</code>
Copying with HTTP	<code>http:// [[<username>:<password>]@ {<hostname> <host-ip>} [/<filepath>] /<filename></code>	To specify a file in the configs directory on the server: <code>http://www.company.com/configs/example.cfg</code>
Copying with TFTP	<code>tftp:// [[<location>] /<directory>] /<filename></code>	To specify a file in the top-level directory of the server: <code>tftp://172.1.1.1/example.cfg</code>
Copying with SCP	<code>scp://<username>@<location> [/<directory>] [/<filename>]</code>	To specify a file in the configs directory on the server, logging on as user 'bob': e.g. <code>scp://bob@10.10.0.12/configs/example.cfg</code>
Copying with SFTP	<code>sftp:// [[<location>] /<directory>] /<filename></code>	To specify a file in the top-level directory of the server: <code>sftp://10.0.0.5/example.cfg</code>

Valid characters The filename and path can include characters from up to four categories. The categories are:

- 1) uppercase letters: A to Z
- 2) lowercase letters: a to z
- 3) digits: 0 to 9
- 4) special symbols: most printable ASCII characters not included in the previous three categories, including the following characters:
 - -
 - /
 - .
 - _
 - @
 - "
 - '
 - *
 - :
 - ~
 - ?

Do not use spaces, parentheses or the + symbol within filenames. Use hyphens or underscores instead.

Syntax for directory listings

A leading slash (/) indicates the root of the current file system location.

In commands where you need to specify the local file system's flash base directory, you may use **flash** or **flash:** or **flash:/**. For example, these commands are all the same:

- `dir flash`
- `dir flash:`
- `dir flash:/`

Similarly, you can specify the USB storage device base directory with **usb** or **usb:** or **usb:/**

You cannot name a directory or subdirectory **flash**, **nvs**, **usb**, **card**, **tftp**, **scp**, **sftp** or **http**. These keywords are reserved for tab completion when using various file commands.

Command List

- "[autoboot enable](#)" on page 155
- "[boot config-file](#)" on page 156
- "[boot config-file backup](#)" on page 158
- "[boot system](#)" on page 159

- [“boot system backup”](#) on page 161
- [“cd”](#) on page 162
- [“copy \(filename\)”](#) on page 163
- [“copy debug”](#) on page 165
- [“copy running-config”](#) on page 166
- [“copy startup-config”](#) on page 167
- [“copy zmodem”](#) on page 168
- [“create autoboot”](#) on page 169
- [“delete”](#) on page 170
- [“delete debug”](#) on page 171
- [“dir”](#) on page 172
- [“edit”](#) on page 174
- [“edit \(filename\)”](#) on page 175
- [“erase factory-default”](#) on page 176
- [“erase startup-config”](#) on page 177
- [“ip tftp source-interface”](#) on page 178
- [“ip tftp vrf”](#) on page 179
- [“ipv6 tftp source-interface”](#) on page 180
- [“mkdir”](#) on page 181
- [“move”](#) on page 182
- [“move debug”](#) on page 183
- [“pwd”](#) on page 184
- [“rmdir”](#) on page 185
- [“show autoboot”](#) on page 186
- [“show boot”](#) on page 187
- [“show file”](#) on page 189
- [“show file systems”](#) on page 190
- [“show running-config”](#) on page 192
- [“show running-config interface”](#) on page 195
- [“show startup-config”](#) on page 198
- [“show version”](#) on page 199
- [“unmount”](#) on page 200
- [“write file”](#) on page 201
- [“write memory”](#) on page 202
- [“write terminal”](#) on page 203

autoboot enable

Overview This command enables the device to restore a release file and/or a configuration file from a USB storage device.

When the Autoboot feature is enabled, the device looks for a special file called `autoboot.txt` on the external media. If this file exists, the device will check the key and values in the file and recover the device with a new release file and/or configuration file from the external media. An example of a valid `autoboot.txt` file is shown in the following figure.

Figure 3-1: Example `autoboot.txt` file

```
[AlliedWare Plus]
Copy_from_external_media_enabled=yes
Boot_Release=AR2050V-5.5.2-1.1.rel
Boot_Config=network1.cfg
```

Use the **no** variant of this command to disable the Autoboot feature.

Syntax `autoboot enable`
`no autoboot enable`

Default The Autoboot feature operates the first time the device is powered up in the field, after which the feature is disabled by default.

Mode Global Configuration

Example To enable the Autoboot feature, use the command:

```
awplus# configure terminal
awplus(config)# autoboot enable
```

Related commands [create autoboot](#)
[show autoboot](#)
[show boot](#)

boot config-file

Overview Use this command to set the configuration file to use during the next boot cycle. Use the **no** variant of this command to remove the configuration file.

Syntax `boot config-file <filepath-filename>`
`no boot config-file`

Parameter	Description
<code><filepath-filename></code>	Filepath and name of a configuration file. The specified configuration file must exist in the specified filesystem. Valid configuration files must have a .cfg extension.

Mode Global Configuration

Usage notes You can only specify that the configuration file is on a USB storage device if there is a backup configuration file already specified in flash. If you attempt to set the configuration file on a USB storage device and a backup configuration file is not specified in flash, the following error message is displayed:

```
% Backup configuration files must be stored in the flash filesystem
```

For an explanation of the configuration fallback order, see the [File Management Feature Overview and Configuration Guide](#).

Examples To run the configuration file "branch.cfg" the next time the device boots up, when "branch.cfg" is stored on the device's flash filesystem, use the commands:

```
awplus# configure terminal
awplus(config)# boot config-file flash:/branch.cfg
```

To stop running the configuration file "branch.cfg" when the device boots up, when "branch.cfg" is stored on the device's flash filesystem, use the commands:

```
awplus# configure terminal
awplus(config)# no boot config-file flash:/branch.cfg
```

To run the configuration file "branch.cfg" the next time the device boots up, when "branch.cfg" is stored on a USB storage device, use the commands:

```
awplus# configure terminal
awplus(config)# boot config-file usb:/branch.cfg
```

To stop running the configuration file “branch.cfg” when the device boots up, when “branch.cfg” is stored on a USB storage device, use the commands:

```
awplus# configure terminal
```

```
awplus(config)# no boot config-file usb:/branch.cfg
```

Related commands

- [boot config-file backup](#)
- [boot system](#)
- [boot system backup](#)
- [show boot](#)

boot config-file backup

Overview Use this command to set a backup configuration file to use if the main configuration file cannot be accessed.

Use the **no** variant of this command to remove the backup configuration file.

Syntax `boot config-file backup <filepath-filename>`
`no boot config-file backup`

Parameter	Description
<code><filepath-filename></code>	Filepath and name of a backup configuration file. Backup configuration files must be in the flash filesystem. Valid backup configuration files must have a .cfg extension.
<code>backup</code>	The specified file is a backup configuration file.

Mode Global Configuration

Usage notes For an explanation of the configuration fallback order, see the [File Management Feature Overview and Configuration Guide](#).

Examples To set the configuration file `backup.cfg` as the backup to the main configuration file, use the commands:

```
awplus# configure terminal
awplus(config)# boot config-file backup flash:/backup.cfg
```

To remove the configuration file `backup.cfg` as the backup to the main configuration file, use the commands:

```
awplus# configure terminal
awplus(config)# no boot config-file backup flash:/backup.cfg
```

Related commands

- [boot config-file](#)
- [boot system](#)
- [boot system backup](#)
- [show boot](#)

boot system

Overview Use this command to set the release file to load during the next boot cycle.

Use the **no** variant of this command to stop specifying a primary release file to boot from. If the device boots up with no release file set, it will use autoboot or the backup release file if either of those are configured. You can also use the boot menu to select a release file source. To access the boot menu, type Ctrl-B at bootup.

Syntax `boot system <filepath-filename>`
`no boot system`

Parameter	Description
<code><filepath-filename></code>	Filepath and name of a release file. The specified release file must exist and must be stored in the root directory of the specified filesystem. Valid release files must have a .rel extension.

Mode Global Configuration

Usage notes You can only specify that the release file is on a USB storage device if there is a backup release file already specified in flash. If you attempt to set the release file on a USB storage device and a backup release file is not specified in flash, the following error message is displayed:

```
% A backup boot image must be set before setting a current boot image on USB storage device
```

Examples To boot up with the release file AR2050V-5.5.2-1.1.rel the next time the device boots up, when the release file is stored on the device's flash filesystem, use the commands:

```
awplus# configure terminal  
awplus(config)# boot system flash:/AR2050V-5.5.2-1.1.rel
```

To run the release file AR2050V-5.5.2-1.1.rel the next time the device boots up, when the release file is stored on a USB storage device, use the commands:

```
awplus# configure terminal  
awplus(config)# boot system usb:/AR2050V-5.5.2-1.1.rel
```

Related commands

- boot config-file
- boot config-file backup
- boot system backup
- show boot

boot system backup

Overview Use this command to set a backup release file to load if the main release file cannot be loaded.

Use the **no** variant of this command to stop specifying a backup release file.

Syntax `boot system backup <filepath-filename>`
`no boot system backup`

Parameter	Description
<code><filepath-filename></code>	Filepath and name of a backup release file. Backup release files must be in the Flash filesystem. Valid release files must have a .rel extension.
<code>backup</code>	The specified file is a backup release file.

Mode Global Configuration

Examples To specify the file AR2050V-5.5.2-0.1.rel as the backup to the main release file, use the commands:

```
awplus# configure terminal
awplus(config)# boot system backup flash:/AR2050V-5.5.2-0.1.rel
```

To stop specifying a backup to the main release file, use the commands:

```
awplus# configure terminal
awplus(config)# no boot system backup
```

Related commands

- [boot config-file](#)
- [boot config-file backup](#)
- [boot system](#)
- [show boot](#)

cd

Overview This command changes the current working directory.

Syntax `cd <directory-name>`

Parameter	Description
<code><directory-name></code>	Name and path of the directory.

Mode Privileged Exec

Example To change to the directory called `images`, use the command:

```
awplus# cd images
```

Related commands

- `dir`
- `pwd`
- `show file systems`

copy (filename)

Overview This command copies a file. This allows you to:

- copy files from your device to a remote device
- copy files from a remote device to your device
- copy files stored on Flash memory to or from a different memory type, such as a USB storage device
- create two copies of the same file on your device

Syntax `copy [force] <source-name> <destination-name>`

Parameter	Description
<code>force</code>	This parameter forces the copy command to overwrite the destination file, if it already exists, without prompting the user for confirmation.
<code><source-name></code>	The filename and path of the source file. See Introduction on page 152 for valid syntax.
<code><destination-name></code>	The filename and path for the destination file. See Introduction on page 152 for valid syntax.

Mode Privileged Exec

Examples To use TFTP to copy the file "bob.key" into the current directory from the remote server at 10.0.0.1, use the command:

```
awplus# copy tftp://10.0.0.1/bob.key bob.key
```

To use SFTP to copy the file "new.cfg" into the current directory from a remote server at 10.0.1.2, use the command:

```
awplus# copy sftp://10.0.1.2/new.cfg bob.key
```

To use SCP with the username "beth" to copy the file old.cfg into the directory config_files on a remote server that is listening on TCP port 2000, use the command:

```
awplus# copy scp://beth@serv:2000/config_files/old.cfg old.cfg
```

To copy the file "newconfig.cfg" onto your device's Flash from a USB storage device, use the command:

```
awplus# copy usb:/newconfig.cfg flash:/newconfig.cfg
```

To copy the file "newconfig.cfg" to a USB storage device from your device's Flash, use the command:

```
awplus# copy flash:/newconfig.cfg usb:/newconfig.cfg
```

To copy the file "config.cfg" into the current directory from a USB storage device, and rename it to "configtest.cfg", use the command:

```
awplus# copy usb:/config.cfg configtest.cfg
```

To copy the file "config.cfg" into the current directory from a remote file server, and rename it to "configtest.cfg", use the command:

```
awplus# copy fserver:/config.cfg configtest.cfg
```

On an AMF network, to copy the device GUI file from the AMF master to the Flash memory of 'node_1', use the command:

```
master# copy awplus-gui_549_13.gui node_1.atmf/flash:
```

**Related
commands**

[copy zmodem](#)

[copy buffered-log](#)

[copy permanent-log](#)

[edit \(filename\)](#)

[show file systems](#)

copy debug

Overview This command copies a specified debug file to a destination file.

Syntax `copy debug {<destination-name>|debug|flash|nvs|scp|tftp|usb}`
`{<source-name>|debug|flash|nvs|scp|tftp|usb}`

Parameter	Description
<code><destination-name></code>	The filename and path where you would like the debug output saved. See Introduction on page 152 for valid syntax.
<code><source-name></code>	The filename and path where the debug output originates. See the Introduction to this chapter for valid syntax.

Mode Privileged Exec

Example To copy debug output to a file on flash called “my-debug”, use the following command:

```
awplus# copy debug flash:my-debug
```

To copy debug output to a USB storage device with a filename “my-debug”, use the following command:

```
awplus# copy debug usb:my-debug
```

Output Figure 3-2: CLI prompt after entering the **copy debug** command

```
Enter source file name []:
```

Related commands [delete debug](#)
[move debug](#)

copy running-config

Overview This command copies the running-config to a destination file, or copies a source file into the running-config. Commands entered in the running-config do not survive a device reboot unless they are saved in a configuration file.

Syntax

```
copy <source-name> running-config  
copy running-config [<destination-name>]  
copy running-config startup-config
```

Parameter	Description
<source-name>	The filename and path of a configuration file. This must be a valid configuration file with a .cfg filename extension. Specify this when you want the script in the file to become the new running-config. See Introduction on page 152 for valid syntax.
<destination-name>	The filename and path where you would like the current running-config saved. This command creates a file if no file exists with the specified filename. If a file already exists, then the CLI prompts you before overwriting the file. See Introduction on page 152 for valid syntax. If you do not specify a file name, the device saves the running-config to a file called default.cfg.
startup-config	Copies the running-config into the file set as the current startup-config file.

Mode Privileged Exec

Examples To copy the running-config into the startup-config, use the command:

```
awplus# copy running-config startup-config
```

To copy the file 'layer3.cfg' into the running-config, use the command:

```
awplus# copy layer3.cfg running-config
```

To use SCP to copy the running-config as 'current.cfg' to the remote server listening on TCP port 2000, use the command:

```
awplus# copy running-config  
scp://user@server:2000/config_files/current.cfg
```

Related commands

- [copy startup-config](#)
- [write file](#)
- [write memory](#)

copy startup-config

Overview This command copies the startup-config script into a destination file, or alternatively copies a configuration script from a source file into the startup-config file.

Syntax `copy <source-name> startup-config`
`copy startup-config <destination-name>`

Parameter	Description
<code><source-name></code>	The filename and path of a configuration file. This must be a valid configuration file with a .cfg filename extension. Specify this to copy the script in the file into the startup-config file. Note that this does not make the copied file the new startup file, so any further changes made in the configuration file are not added to the startup-config file unless you reuse this command. See Introduction on page 152 for valid syntax.
<code><destination-name></code>	The destination and filename that you are saving the startup-config as. This command creates a file if no file exists with the specified filename. If a file already exists, then the CLI prompts you before overwriting the file. See Introduction on page 152 for valid syntax.

Mode Privileged Exec

Examples To copy the file 'Layer3.cfg' to the startup-config, use the command:

```
awplus# copy Layer3.cfg startup-config
```

To copy the startup-config as the file 'oldconfig.cfg' in the current directory, use the command:

```
awplus# copy startup-config oldconfig.cfg
```

Related commands [copy running-config](#)

copy zmodem

Overview This command allows you to copy files using ZMODEM using Minicom. ZMODEM works over a serial connection and does not need any interfaces configured to do a file transfer.

Syntax `copy <source-name> zmodem`
`copy zmodem`

Parameter	Description
<code><source-name></code>	The filename and path of the source file. See Introduction on page 152 for valid syntax.

Mode Privileged Exec

Example To copy the local file 'asuka.key' using ZMODEM, use the command:

```
awplus# copy asuka.key zmodem
```

Related commands [copy \(filename\)](#)
[show file systems](#)

create autoboot

Overview Use this command to create an autoboot.txt file on an external storage device. This command will automatically ensure that the keys and values that are expected in this file are correct. After the file is created the **create autoboot** command will copy the current release and configuration files across to the external storage device. The external storage device is then available to restore a release file and/or a configuration file to the device.

Syntax `create autoboot usb`

Mode Privileged Exec

Example To create an autoboot.txt file on a USB storage device, use the command:

```
awplus# create autoboot usb
```

Related commands

- [autoboot enable](#)
- [show autoboot](#)
- [show boot](#)

delete

Overview This command deletes files or directories.

Syntax delete [force] [recursive] <filename>

Parameter	Description
force	Ignore nonexistent filenames and never prompt before deletion.
recursive	Remove the contents of directories recursively.
<filename>	The filename and path of the file to delete. See Introduction on page 152 for valid syntax.

Mode Privileged Exec

Examples To delete the file `temp.cfg` from the current directory, use the command:

```
awplus# delete temp.cfg
```

To delete the read-only file `one.cfg` from the current directory, use the command:

```
awplus# delete force one.cfg
```

To delete the directory `old_configs`, which is not empty, use the command:

```
awplus# delete recursive old_configs
```

To delete the directory `new_configs`, which is not empty, without prompting if any read-only files are being deleted, use the command:

```
awplus# delete force recursive new_configs
```

Related commands [erase startup-config](#)
[rmdir](#)

delete debug

Overview Use this command to delete a specified debug output file.

Syntax delete debug <source-name>

Parameter	Description
<source-name>	The filename and path where the debug output originates. See Introduction on page 152 for valid URL syntax.

Mode Privileged Exec

Example To delete debug output, use the following command:

```
awplus# delete debug
```

Output Figure 3-3: CLI prompt after entering the **delete debug** command

```
Enter source file name []:
```

Related commands [copy debug](#)
[move debug](#)

dir

Overview This command lists the files on a filesystem. If you don't specify a directory or file, then this command lists the files in the current directory.

Syntax `dir [all] [recursive] [sort [reverse] [name|size|time]]`
`[<filename>|debug|flash|nvs|usb]`

Parameter	Description
all	List all files.
recursive	List the contents of directories recursively.
sort	Sort directory listing.
reverse	Sort using reverse order.
name	Sort by name.
size	Sort by size.
time	Sort by modification time (default).
<filename>	The name of the directory or file. If you don't specify a directory or file, then this command lists the files in the current directory.
debug	Debug root directory
flash	Flash memory root directory
nvs	NVS memory root directory
usb	USB storage device root directory

Mode Privileged Exec

Examples To list the files in the current working directory, use the command:

```
awplus# dir
```

To list the non-hidden files in the root of the Flash filesystem, use the command:

```
awplus# dir flash
```

To list all the files in the root of the Flash filesystem, use the command:

```
awplus# dir all flash:
```

To list recursively the files in the Flash filesystem, use the command:

```
awplus# dir recursive flash:
```

To list the files in alphabetical order, use the command:

```
awplus# dir sort name
```

To list the files by size, smallest to largest, use the command:

```
awplus# dir sort reverse size
```

To sort the files by modification time, oldest to newest, use the command:

```
awplus# dir sort reverse time
```

Output Figure 3-4: Example output from the **dir** command

```
awplus#dir
  630 -rw- May 19 2016 23:36:31  example.cfg
23652123 -rw- May 17 2016 03:41:18
  149 -rw- Feb  9 2016 00:40:35  exception.log
```

Related commands [cd](#)
[pwd](#)

edit

Overview This command opens a text file in the AlliedWare Plus™ text editor. Once opened you can use the editor to alter to the file.

If a filename is specified and it already exists, then the editor opens it in the text editor.

If no filename is specified, the editor prompts you for one when you exit it.

Before starting the editor make sure your terminal, terminal emulation program, or Telnet client is 100% compatible with a VT100 terminal. The editor uses VT100 control sequences to display text on the terminal.

For more information about using the editor, including control sequences, see the [File Management Feature Overview and Configuration Guide](#).

Syntax `edit [<filename>]`

Parameter	Description
<code><filename></code>	Name of a file in the local Flash filesystem.

Mode Privileged Exec

Examples To create and edit a new text file, use the command:

```
awplus# edit
```

To edit the existing configuration file `myconfig.cfg` stored on your device's Flash memory, use the command:

```
awplus# edit myconfig.cfg
```

Related commands [edit \(filename\)](#)
[show file](#)

edit (filename)

Overview This command opens a remote text file as read-only in the AlliedWare Plus™ text editor.

Before starting the editor make sure your terminal, terminal emulation program, or Telnet client is 100% compatible with a VT100 terminal. The editor uses VT100 control sequences to display text on the terminal.

Syntax `edit <filename>`

Parameter	Description
<code><filename></code>	The filename and path of the remote file. See Introduction on page 152 for valid syntax.

Mode Privileged Exec

Example To view the file `bob.key` stored in the security directory of a TFTP server, use the command:

```
awplus# edit tftp://security/bob.key
```

Related commands

- [copy \(filename\)](#)
- [edit](#)
- [show file](#)

erase factory-default

Overview This command erases all data from NVS and all data from flash **except** the following:

- the boot release file (a .rel file) and its release setting file
- all license files
- the latest GUI release file

The device is then rebooted and returned to its factory default condition. The device can then be used for AMF automatic node recovery.

Syntax `erase factory-default`

Mode Privileged Exec

Usage notes This command is an alias to the [atmf cleanup](#) command.

Example To erase data, use the command:

```
Node_1# erase factory-default
```

```
This command will erase all NVS, all flash contents except for  
the boot release, a GUI resource file, and any license files,  
and then reboot the switch. Continue? (y/n):y
```

Related commands [atmf cleanup](#)

erase startup-config

Overview This command deletes the file that is set as the startup-config file, which is the configuration file that the system runs when it boots up.

At the next restart, the device loads the default configuration file, default.cfg. If default.cfg no longer exists, then the device loads with the factory default configuration. This provides a mechanism for you to return the device to the factory default settings.

Syntax `erase startup-config`

Mode Privileged Exec

Example To delete the file currently set as the startup-config, use the command:

```
awplus# erase startup-config
```

Related commands

- [boot config-file backup](#)
- [copy running-config](#)
- [copy startup-config](#)
- [show boot](#)

ip tftp source-interface

Overview Use this command to manually specify the IP address that all TFTP requests originate from. This is useful in network configurations where TFTP servers only accept requests from certain devices, or where the server cannot dynamically determine the source of the request.

Use the **no** variant of this command to stop specifying a source.

Syntax `ip tftp source-interface [<interface>|<ip-add>]`
`no ip tftp source-interface`

Parameter	Description
<code><interface></code>	The interface that TFTP requests originate from. The device will use the IP address of this interface as its source IP address. You can specify any interface that can have an IP address attached to it (e.g. a VLAN, PPP or Eth interface).
<code><ip-add></code>	The IP address that TFTP requests originate from, in dotted decimal format.

Default There is no default source specified.

Mode Global Configuration

Usage This command is helpful in network configurations where TFTP traffic needs to traverse point-to-point links or subnets within your network, and you do not want to propagate those point-to-point links through your routing tables.

In those circumstances, the TFTP server cannot dynamically determine the source of the TFTP request, and therefore cannot send the requested data to the correct device. Specifying a source interface or address enables the TFTP server to send the data correctly.

Example To specify that TFTP requests originate from the IP address 192.0.2.1, use the following commands:

```
awplus# configure terminal
awplus(config)# ip tftp source-interface 192.0.2.1
```

Related commands [copy \(filename\)](#)

ip tftp vrf

Overview Use this command to specify a VRF to use when copying a file via TFTP.
Use the **no** variant of this command to remove the VRF from the configuration and set it back to the default VRF.

Syntax `ip tftp vrf <vrf-name>`
`no ip tftp vrf`

Parameter	Description
<code>vrf</code> <code><vrf-name></code>	Specify the VRF to use when copying a file using TFTP.

Default Global VRF

Mode Global Configuration

Example To configure a VRF called 'red' to use when copying a file via TFTP, use the commands:

```
awplus# configure terminal
awplus(config)# ip tftp vrf red
```

Related commands [copy \(filename\)](#)

Command changes Version 5.5.2-1.1: command added

ipv6 tftp source-interface

Overview Use this command to manually specify the IPv6 address that all TFTP requests originate from. This is useful in network configurations where TFTP servers only accept requests from certain devices, or where the server cannot dynamically determine the source of the request.

Use the **no** variant of this command to stop specifying a source.

Syntax `ipv6 tftp source-interface [<interface>|<ipv6-add>]`
`no ipv6 tftp source-interface`

Parameter	Description
<code><interface></code>	The interface that TFTP requests originate from. The device will use the IPv6 address of this interface as its source IPv6 address. You can specify any interface that can have an IPv6 address attached to it (e.g. a VLAN, PPP or Eth interface).
<code><ipv6-add></code>	The IPv6 address that TFTP requests originate from, in the format x:x:x:x, for example, 2001:db8::8a2e:7334.

Default There is no default source specified.

Mode Global Configuration

Usage This command is helpful in network configurations where TFTP traffic needs to traverse point-to-point links or subnets within your network, and you do not want to propagate those point-to-point links through your routing tables.

In those circumstances, the TFTP server cannot dynamically determine the source of the TFTP request, and therefore cannot send the requested data to the correct device. Specifying a source interface or address enables the TFTP server to send the data correctly.

Example To specify that TFTP requests originate from the IPv6 address 2001:db8::8a2e:7334, use the following commands:

```
awplus# configure terminal
awplus(config)# ipv6 tftp source-interface 2001:db8::8a2e:7334
```

Related commands [copy \(filename\)](#)

mkdir

Overview This command makes a new directory.

Syntax `mkdir <name>`

Parameter	Description
<code><name></code>	The name and path of the directory that you are creating.

Mode Privileged Exec

Usage You cannot name a directory or subdirectory **flash**, **nvs**, **usb**, **card**, **tftp**, **scp**, **sftp** or **http**. These keywords are reserved for tab completion when using various file commands.

Example To make a new directory called `images` in the current directory, use the command:

```
awplus# mkdir images
```

Related commands `cd`
`dir`
`pwd`

move

Overview This command renames or moves a file.

Syntax `move <source-name> <destination-name>`

Parameter	Description
<code><source-name></code>	The filename and path of the source file. See Introduction on page 152 for valid syntax.
<code><destination-name></code>	The filename and path of the destination file. See Introduction on page 152 for valid syntax.

Mode Privileged Exec

Examples To rename the file `temp.cfg` to `startup.cfg`, use the command:

```
awplus# move temp.cfg startup.cfg
```

To move the file `temp.cfg` from the root of the Flash filesystem to the directory `myconfigs`, use the command:

```
awplus# move temp.cfg myconfigs/temp.cfg
```

Related commands [delete](#)
[edit](#)

[show file](#)

[show file systems](#)

move debug

Overview This command moves a specified debug file to a destination debug file.

Syntax `move debug {<destination-name>|debug|nvs|flash|usb}`

Parameter	Description
<code><destination-name></code>	The filename and path where you would like the debug output moved to. See Introduction on page 152 for valid syntax.

Mode Privileged Exec

Example To move debug output into Flash memory with a filename “my-debug”, use the following command:

```
awplus# move debug flash:my-debug
```

To move debug output onto a USB storage device with a filename “my-debug”, use the following command:

```
awplus# move debug usb:my-debug
```

Output Figure 3-5: CLI prompt after entering the **move debug** command

```
Enter source file name []:
```

Related commands
[copy debug](#)
[delete debug](#)

pwd

Overview This command prints the current working directory.

Syntax `pwd`

Mode Privileged Exec

Example To print the current working directory, use the command:

```
awplus# pwd
```

Related commands `cd`

rmdir

Overview This command removes a directory. This command only works on empty directories, unless you specify the optional **force** keyword.

Syntax `rmdir [force] <name>`

Parameter	Description
<code>force</code>	Optional keyword that allows you to delete directories that are not empty and contain files or subdirectories.
<code><name></code>	The name and path of the directory.

Mode Privileged Exec

Usage notes You can use the CLI to access filesystems on a specific external memory device. See the [Introduction](#) on page 152 for syntax details.

Examples To remove the directory “images” from the top level of the Flash filesystem, use the command:

```
awplus# rmdir flash:/images
```

To create a directory called “level1” containing a subdirectory called “level2”, and then force the removal of both directories, use the commands:

```
awplus# mkdir level1
awplus# mkdir level1/level2
awplus# rmdir force level1
```

Related commands

- [cd](#)
- [dir](#)
- [mkdir](#)
- [pwd](#)

show autoboot

Overview This command displays the Autoboot configuration and status.

Syntax show autoboot

Mode Privileged Exec

Example To show the Autoboot configuration and status, use the command:

```
awplus# show autoboot
```

Output Figure 3-6: Example output from the **show autoboot** command

```
awplus#show autoboot
Autoboot configuration
-----
Autoboot status           : enabled
USB file autoboot.txt exists : yes

Restore information on USB
Autoboot enable in autoboot.txt : yes
Restore release file       : AR2050V-5.5.2-1.1.rel (file exists)
Restore configuration file  : network_1.cfg (file exists)
```

Figure 3-7: Example output from the **show autoboot** command when an external media source is not present

```
awplus#show autoboot
Autoboot configuration
-----
Autoboot status           : enabled
External media source     : USB not found.
```

Related commands

- [autoboot enable](#)
- [create autoboot](#)
- [show boot](#)

show boot

Overview This command displays the current boot configuration.
We recommend that the currently running release is set as the current boot image.

Syntax show boot

Mode Privileged Exec

Example To show the current boot configuration, use the command:

```
awplus# show boot
```

Output Figure 3-8: Example output from **show boot**

```
awplus#show boot
Boot configuration
-----
Current software   : AR2050V-5.5.2-1.1.rel
Current boot image : flash:/AR2050V-5.5.2-1.1.rel
Backup boot image  : flash:/AR2050V-5.5.2-0.1.rel
Default boot config: flash:/default.cfg
Current boot config: flash:/my.cfg (file exists)
Backup boot config : flash:/backup.cfg (file not found)
Autoboot status    : disabled
```

Table 3-1: Parameters in the output from **show boot**

Parameter	Description
Current software	The current software release that the device is using.
Current boot image	The boot image currently configured for use during the next boot cycle.
Backup boot image	The boot image to use during the next boot cycle if the device cannot load the main image.
Default boot config	The default startup configuration file. The device loads this configuration script if no file is set as the startup-config file.
Current boot config	The configuration file currently configured as the startup-config file. The device loads this configuration file during the next boot cycle if this file exists.
Backup boot config	The configuration file to use during the next boot cycle if the main configuration file cannot be loaded.
Autoboot status	The status of the Autoboot feature; either enabled or disabled.

Related commands

- autoboot enable
- boot config-file backup
- boot system backup
- show autoboot

show file

Overview This command displays the contents of a specified file.

Syntax `show file <filename>`

Parameter	Description
<code><filename></code>	Name of a file on the local Flash filesystem, or name and directory path of a file.

Mode Privileged Exec

Example To display the contents of the file `oldconfig.cfg`, which is in the current directory, use the command:

```
awplus# show file oldconfig.cfg
```

Related commands

- [edit](#)
- [edit \(filename\)](#)
- [show file systems](#)

show file systems

Overview This command lists the file systems and their utilization information where appropriate.

Syntax `show file systems`

Mode Privileged Exec

Examples To display the file systems, use the command:

```
awplus# show file systems
```

Output Figure 3-9: Example output from the **show file systems** command

```
awplus#show file systems
Size (b)  Free (b)  Type  Flags  Prefixes  S/D/V  Lcl/Ntwk  Avail
-----
 63.0M    28.5M    flash  rw  flash:    static  local      Y
-         -        system rw  system:   virtual local      -
10.0M     9.8M    debug  rw  debug:    static  local      Y
499.0K    431.0K   nvs     rw  nvs:      static  local      Y
-         -        tftp   rw  tftp:     -       network    -
-         -        scp    rw  scp:      -       network    -
-         -        sftp   ro  sftp:     -       network    -
-         -        http   ro  http:     -       network    -
-         -        rsync  rw  rsync:    -       network    -
```

Table 4: Parameters in the output of the **show file systems** command

Parameter	Description
Size (b)	The total memory available to this file system. The units are given after the value and are M for Megabytes or k for kilobytes.
Free (b)	The total memory free within this file system. The units are given after the value and are M for Megabytes or K for kilobytes.
Type	The memory type used for this file system, such as: flash system usbstick tftp scp sftp http.
Flags	The file setting options: rw (read write), ro (read only).

Table 4: Parameters in the output of the **show file systems** command (cont.)

Parameter	Description
Prefixes	The prefixes used when entering commands to access the file systems, such as: flash system usb tftp scp sftp http.
S/D/V	The memory type: Static, Dynamic, Virtual.
Lcl / Ntwk	Whether the memory is located locally or via a network connection.
Avail	Whether the memory is accessible: Y (yes), N (no), - (not applicable)

Related commands

- [edit](#)
- [edit \(filename\)](#)
- [show file](#)

show running-config

Overview This command displays the current configuration of your device. Its output includes all non-default configuration. The default settings are not displayed.

NOTE: You can control the output by entering `|` or `>` at the end of the command:

- To display only lines that contain a particular word, enter:

```
| include <word>
```

- To start the display at the first line that contains a particular word, enter:

```
| begin <word>
```

- To save the output to a file, enter:

```
> <filename>
```

Syntax `show running-config [full|<feature>]`

Parameter	Description
full	Display the running-config for all features. This is the default setting, so it is the same as entering show running-config .
<feature>	Display only the configuration for a single feature. The features available depend on your device and will be some of the following list:
access-list	ACL configuration
antivirus	Antivirus configuration
application	Application configuration
as-path	Autonomous system path filter configuration
as-path access-list	Configuration of ACLs for AS path filtering
atmf	Allied Telesis Management Framework configuration
bgp	Border Gateway Protocol (BGP) configuration
community-list	Community-list configuration
crypto	Security-specific configuration
dhcp	DHCP configuration
dpi	Deep Packet Inspection configuration
entity	Entity configuration
firewall	Firewall configuration
interface	Interface configuration. See show running-config interface for further options.

Parameter	Description
ip	Internet Protocol (IP) configuration
ip pim dense-mode	PIM-DM configuration
ip pim sparse-mode	PIM-SM configuration
ip route	IP static route configuration
ip-reputation	IP Reputation configuration
ips	IPS configuration
ipsec	Internet Protocol Security (IPsec) configuration
ipv6	Internet Protocol version 6 (IPv6) configuration
ipv6 access-list	IPv6 ACL configuration
ipv6 mroute	IPv6 multicast route configuration
ipv6 prefix-list	IPv6 prefix list configuration
ipv6 route	IPv6 static route configuration
isakmp	Internet Security Association Key Management Protocol (ISAKMP) configuration
key chain	Authentication key management configuration
l2tp-profile	L2TP tunnel profile configuration
lldp	LLDP configuration
log	Logging utility configuration
malware-protection	Malware protection configuration
nat	Network Address Translation configuration
power-inline	Power over Ethernet (PoE) configuration
policy-based-routing	Policy-based routing (PBR) configuration
pppoe-ac	PPPoE access concentrator configuration
prefix-list	Prefix-list configuration
route-map	Route-map configuration
router	Router configuration
router-id	Configuration of the router identifier for this system
security-password	Strong password security configuration
snmp	SNMP configuration
ssh	Secure Shell configuration

Parameter	Description
switch	Switch configuration
web-control	Web Control configuration

Mode Privileged Exec and Global Configuration

Example To display the current configuration of your device, use the command:

```
awplus# show running-config
```

Output Figure 3-10: Example output from **show running-config**

```
awplus#show running-config
!
service password-encryption
!
no banner motd
!
username manager privilege 15 password 8 $1$bJoVec4D$JwOJGPr7YqoExA0GVasdE0
!
service ssh
!
no service telnet
!
service http
!
no clock timezone

...

line con 0
line vty 0 4
!
end
```

Related commands [copy running-config](#)
[show running-config interface](#)

show running-config interface

Overview This command displays the current configuration of one or more interfaces on the device.

You can optionally limit the command output to display only information for a given protocol or feature. The features available depend on your device and will be a subset of the features listed in the table below.

Syntax `show running-config interface`
`show running-config interface <interface-list>`
`show running-config interface <interface-list> <feature>`
`show running-config interface <interface-list> ip <feature>`
`show running-config interface <interface-list> ipv6 <feature>`

Parameter	Description
<interface-list>	<p>The interfaces or ports to display information about. An interface-list can be:</p> <ul style="list-style-type: none">• a PPP interface (e.g. ppp0)• an Eth interface (e.g. eth1)• an 802.1Q Ethernet sub-interface (e.g. eth1.10, where '10' is the VLAN ID specified by the encapsulation dot1q command)• a VLAN (e.g. vlan2)• a switchport (e.g. port1.0.4)• a static channel group (e.g. sa2)• a dynamic (LACP) channel group (e.g. po2)• a bridge interface (e.g. br0)• a tunnel interface (e.g. tunnel0)• a 3G cellular interface (e.g. cellular0)• a WWAN interface (e.g. wwan0)• the loopback interface (lo)• a continuous range of interfaces, separated by a hyphen (e.g. ppp2-4)• a comma-separated list (e.g. ppp0,ppp2-4). Do not mix interface types in a list. <p>The specified interfaces must exist.</p>
cfm	Displays running configuration for CFM (Connectivity Fault Management) for the specified interfaces.
dot1x	Displays running configuration for 802.1X port authentication for the specified interfaces.
lACP	Displays running configuration for LACP (Link Aggregation Control Protocol) for the specified interfaces.

Parameter	Description
ip igmp	Displays running configuration for IGMP (Internet Group Management Protocol) for the specified interfaces.
ip multicast	Displays running configuration for general multicast settings for the specified interfaces.
ip pim sparse-mode	Displays running configuration for PIM-SM (Protocol Independent Multicast - Sparse Mode) for the specified interfaces.
ip pim dense-mode	Displays running configuration for PIM-DM (Protocol Independent Multicasting - Dense Mode) for the specified interfaces.
mstp	Displays running configuration for MSTP (Multiple Spanning Tree Protocol) for the specified interfaces.
ospf	Displays running configuration for OSPF (Open Shortest Path First) for the specified interfaces.
rip	Displays running configuration for RIP (Routing Information Protocol) for the specified interfaces.
ipv6 rip	Displays running configuration for RIPng (RIP for IPv6) for the specified interfaces.
ipv6 ospf	Displays running configuration for IPv6 OSPF (Open Shortest Path First) for the specified interfaces.
ipv6 pim sparse-mode	Displays running configuration for PIM-SM (Protocol Independent Multicast - Sparse Mode) for the specified interfaces.
rstp	Displays running configuration for RSTP (Rapid Spanning Tree Protocol) for the specified interfaces.
stp	Displays running configuration for STP (Spanning Tree Protocol) for the specified interfaces.

Mode Privileged Exec and Global Configuration

Default Displays information for all protocols on all interfaces

Examples To display the current running configuration of your device for eth1, use the command:

```
awplus# show running-config interface eth1
```

To display the current running configuration of a device for vlan2, use the command:

```
awplus# show running-config interface vlan2
```

To display the current OSPF configuration of your device for ports 1 to 4, use the command:

```
awplus# show running-config interface port1.0.1-port1.0.4 ospf
```

Output Figure 3-11: Example output from a **show running-config interface ppp0** command

```
awplus#show running-config interface ppp0
!  
interface ppp0  
  ipv6 address 2001:db9::a3/64  
  ipv6 enable  
  snmp trap link-status  
!
```

Related commands [copy running-config](#)
[show running-config](#)

show startup-config

Overview This command displays the contents of the start-up configuration file, which is the file that the device runs on start-up.

For information on filtering and saving command output, see the [“Getting Started with AlliedWare Plus” Feature Overview and Configuration Guide](#).

Syntax `show startup-config`

Mode Privileged Exec

Example To display the contents of the current start-up configuration file, use the command:

```
awplus# show startup-config
```

Output Figure 3-12: Example output from the **show startup-config** command

```
awplus#show startup-config
!
service password-encryption
!
no banner motd
!
username manager privilege 15 password 8 $1$bJoVec4D$JwOJGPr7YqoExA0GVasdE0
!
service ssh
!
no service telnet
!
service http
!
no clock timezone

...

line con 0
line vty 0 4
!
end
```

- Related commands**
- [boot config-file backup](#)
 - [copy running-config](#)
 - [copy startup-config](#)
 - [erase startup-config](#)
 - [show boot](#)

show version

Overview This command displays the version number and copyright details of the current AlliedWare Plus™ OS your device is running.

Syntax `show version`

Mode User Exec and Privileged Exec

Example To display the version details of your currently installed software, use the command:

```
awplus# show version
```

Related commands [boot system backup](#)
[show boot](#)

unmount

Overview Use this command to unmount an external storage device. We recommend you unmount storage devices before removing them, to avoid file corruption. This is especially important if files may be automatically written to the storage device, such as external log files or AMF backup files.

Syntax `unmount usb`

Parameter	Description
usb	Unmount the USB storage device.

Mode Privileged Exec

Example To unmount a USB storage device and safely remove it from the device, use the command:

```
awplus# unmount usb
```

Related commands

- [clear log external](#)
- [log external](#)
- [show file systems](#)
- [show log config](#)
- [show log external](#)

Command changes Version 5.4.7-1.1: command added

write file

Overview This command copies the running-config into the file that is set as the current startup-config file. This command is a synonym of the **write memory** and **copy running-config startup-config** commands.

Syntax write [file]

Mode Privileged Exec

Example To write configuration data to the start-up configuration file, use the command:

```
awplus# write file
```

Related commands

- [copy running-config](#)
- [write memory](#)
- [show running-config](#)

write memory

Overview This command copies the running-config into the file that is set as the current startup-config file. This command is a synonym of the **write file** and **copy running-config startup-config** commands.

Syntax `write [memory]`

Mode Privileged Exec

Example To write configuration data to the start-up configuration file, use the command:

```
awplus# write memory
```

Related commands

- [copy running-config](#)
- [write file](#)
- [show running-config](#)

write terminal

Overview This command displays the current configuration of the device. This command is a synonym of the [show running-config](#) command.

Syntax `write terminal`

Mode Privileged Exec

Example To display the current configuration of your device, use the command:

```
awplus# write terminal
```

Related commands [show running-config](#)

4

User Access Commands

Introduction

Overview This chapter provides an alphabetical reference of commands used to configure user access.

- Command List**
- [“aaa authentication enable default local”](#) on page 206
 - [“aaa local authentication attempts lockout-time”](#) on page 207
 - [“aaa local authentication attempts max-fail”](#) on page 208
 - [“aaa login fail-delay”](#) on page 209
 - [“clear aaa local user lockout”](#) on page 210
 - [“clear line console”](#) on page 211
 - [“clear line vty”](#) on page 212
 - [“enable password”](#) on page 213
 - [“enable secret \(deprecated\)”](#) on page 215
 - [“exec-timeout”](#) on page 216
 - [“flowcontrol hardware \(asyn/console\)”](#) on page 218
 - [“length \(asyn\)”](#) on page 220
 - [“line”](#) on page 221
 - [“privilege level”](#) on page 223
 - [“security-password history”](#) on page 224
 - [“security-password forced-change”](#) on page 225
 - [“security-password lifetime”](#) on page 226
 - [“security-password min-lifetime-enforce”](#) on page 227
 - [“security-password minimum-categories”](#) on page 228
 - [“security-password minimum-length”](#) on page 229

- [“security-password reject-expired-pwd”](#) on page 230
- [“security-password warning”](#) on page 231
- [“service advanced-vty”](#) on page 232
- [“service password-encryption”](#) on page 233
- [“service telnet”](#) on page 234
- [“show aaa local user locked”](#) on page 235
- [“show privilege”](#) on page 236
- [“show security-password configuration”](#) on page 237
- [“show security-password user”](#) on page 238
- [“show telnet”](#) on page 239
- [“show users”](#) on page 240
- [“telnet”](#) on page 241
- [“telnet server”](#) on page 242
- [“terminal length”](#) on page 243
- [“terminal resize”](#) on page 244
- [“username”](#) on page 245

aaa authentication enable default local

Overview This command enables local privilege level authentication.
Use the **no** variant of this command to disable local privilege level authentication.

Syntax `aaa authentication enable default local`
`no aaa authentication enable default`

Default Local privilege level authentication is enabled by default.

Mode Global Configuration

Usage notes The privilege level configured for a particular user in the local user database is the privilege threshold above which the user is prompted for an [enable \(Privileged Exec mode\)](#) command.

Examples To enable local privilege level authentication, use the following commands:

```
awplus# configure terminal
awplus(config)# aaa authentication enable default local
```

To disable local privilege level authentication, use the following commands:

```
awplus# configure terminal
awplus(config)# no aaa authentication enable default
```

Related commands [aaa authentication login](#)
[enable \(Privileged Exec mode\)](#)
[enable password](#)
[enable secret \(deprecated\)](#)

aaa local authentication attempts lockout-time

Overview This command configures the duration of the user lockout period.

Use the **no** variant of this command to restore the duration of the user lockout period to its default of 300 seconds (5 minutes).

Syntax `aaa local authentication attempts lockout-time <lockout-time>`
`no aaa local authentication attempts lockout-time`

Parameter	Description
<code><lockout-time></code>	<code><0-10000></code> . Time in seconds to lockout the user.

Mode Global Configuration

Default The default for the lockout-time is 300 seconds (5 minutes).

Usage notes While locked out all attempts to login with the locked account will fail. The lockout can be manually cleared by another privileged account using the [clear aaa local user lockout](#) command.

Examples To configure the lockout period to 10 minutes (600 seconds), use the commands:

```
awplus# configure terminal
awplus(config)# aaa local authentication attempts lockout-time
600
```

To restore the default lockout period of 5 minutes (300 seconds), use the commands:

```
awplus# configure terminal
awplus(config)# no aaa local authentication attempts
lockout-time
```

Related commands [aaa local authentication attempts max-fail](#)

aaa local authentication attempts max-fail

Overview This command configures the maximum number of failed login attempts before a user account is locked out. Every time a login attempt fails the failed login counter is incremented.

Use the **no** variant of this command to restore the maximum number of failed login attempts to the default setting (five failed login attempts).

Syntax `aaa local authentication attempts max-fail <failed-logins>`
`no aaa local authentication attempts max-fail`

Parameter	Description
<code><failed-logins></code>	<code><1-32></code> . Number of login failures allowed before locking out a user.

Mode Global Configuration

Default The default for the maximum number of failed login attempts is five failed login attempts.

Usage When the failed login counter reaches the limit configured by this command that user account is locked out for a specified duration configured by the [aaa local authentication attempts lockout-time](#) command.

When a successful login occurs the failed login counter is reset to 0. When a user account is locked out all attempts to login using that user account will fail.

Examples To configure the number of login failures that will lock out a user account to two login attempts, use the commands:

```
awplus# configure terminal
awplus(config)# aaa local authentication attempts max-fail 2
```

To restore the number of login failures that will lock out a user account to the default number of login attempts (five login attempts), use the commands:

```
awplus# configure terminal
awplus(config)# no aaa local authentication attempts max-fail
```

Related commands [aaa local authentication attempts lockout-time](#)
[clear aaa local user lockout](#)

aaa login fail-delay

Overview Use this command to configure the minimum time period between failed login attempts. This setting applies to login attempts via the console, SSH and Telnet. Use the **no** variant of this command to reset the minimum time period to its default value.

Syntax `aaa login fail-delay <1-10>`
`no aaa login fail-delay`

Parameter	Description
<1-10>	The minimum number of seconds required between login attempts

Default 1 second

Mode Global configuration

Example To apply a delay of at least 5 seconds between login attempts, use the following commands:

```
awplus# configure terminal
awplus(config)# aaa login fail-delay 5
```

Related commands [aaa authentication login](#)
[aaa local authentication attempts lockout-time](#)
[clear aaa local user lockout](#)

clear aaa local user lockout

Overview Use this command to clear the lockout on a specific user account or all user accounts.

Syntax `clear aaa local user lockout {username <username>|all}`

Parameter	Description
username	Clear lockout for the specified user.
<username>	Specifies the user account.
all	Clear lockout for all user accounts.

Mode Privileged Exec

Examples To unlock the user account 'bob' use the following command:

```
awplus# clear aaa local user lockout username bob
```

To unlock all user accounts use the following command:

```
awplus# clear aaa local user lockout all
```

Related commands [aaa local authentication attempts lockout-time](#)

clear line console

Overview This command resets a console line. If a terminal session exists on the line then the terminal session is terminated. If console line settings have changed then the new settings are applied.

Syntax `clear line console 0`

Mode Privileged Exec

Example To reset the console line (asyn), use the command:

```
awplus# clear line console 0
% The new settings for console line 0 have been applied
```

Related commands

- [clear line vty](#)
- [flowcontrol hardware \(asyn/console\)](#)
- [line](#)
- [show users](#)

clear line vty

Overview This command resets a VTY line. If a session exists on the line then it is closed.

Syntax `clear line vty <0-32>`

Parameter	Description
<0-32>	Line number

Mode Privileged Exec

Example To reset the first VTY line, use the command:

```
awplus# clear line vty 1
```

Related commands

- [privilege level](#)
- [line](#)
- [show telnet](#)
- [show users](#)

enable password

Overview Use this command to set a local password to control access to elevated privilege levels.

Use the **no** version of the command to remove the password.

Note that the [enable secret \(deprecated\)](#) command is an outdated alias for the **enable password** command.

Syntax

```
enable password [8] <password>  
enable password level <1-15> [8] <password>  
no enable password [level <1-15>]
```

Parameter	Description
<password>	The password. The password can be up to 32 characters in length and include characters from up to four categories. The password categories are: <ul style="list-style-type: none">uppercase letters: A to Zlowercase letters: a to zdigits: 0 to 9special symbols: all printable ASCII characters not included in the previous three categories. The question mark ? cannot be used as it is reserved for help functionality.
8	The parameter 8 means that the password that follows is in hashed form, not plain text. Do not type this 8 when creating a password with this command; it is only used in configuration files. In configuration files, the device prints 8 in front of passwords, to indicate that it is displaying the password in its hashed form. Note that the user needs to enter the plain-text version of the password when logging in.
level	Privilege level <1-15>. Level for which the password applies. You can specify up to 16 privilege levels, using numbers 1 through 15. Level 1 is normal EXEC-mode user privileges for User Exec mode. If this argument is not specified in the command or the no variant of the command, the privilege level defaults to 15 (enable mode privileges) for Privileged Exec mode. A privilege level of 7 can be set for intermediate CLI security.

Default Level 15

Mode Global Configuration

Usage notes This command enables the Network Administrator to set a password for entering the Privileged Exec mode when using the [enable \(Privileged Exec mode\)](#) command.

You can use this command to give a user an intermediate CLI security level (privilege level 7). Such users can access all the show commands in Privileged Exec mode and all the commands in User Exec mode, but not any configuration commands in Privileged Exec mode.

The device stores passwords in hashed form in configuration files, unless you disable [service password-encryption](#).

**Related
commands**

[enable \(Privileged Exec mode\)](#)

[enable secret \(deprecated\)](#)

[service password-encryption](#)

[privilege level](#)

[show privilege](#)

[username](#)

[show running-config](#)

enable secret (deprecated)

Overview This command has been deprecated. It has been replaced by the [enable password](#) command.

exec-timeout

Overview This command sets the interval your device waits for user input from either a console or VTY connection. Once the timeout interval is reached, the connection is dropped. This command sets the time limit when the console or VTY connection automatically logs off after no activity.

The **no** variant of this command removes a specified timeout and resets to the default timeout (10 minutes).

Syntax `exec-timeout {<minutes>} [<seconds>]`
`no exec-timeout`

Parameter	Description
<minutes>	<0-35791> Required integer timeout value in minutes
<seconds>	<0-2147483> Optional integer timeout value in seconds

Default The default for the **exec-timeout** command is 10 minutes and 0 seconds (**exec-timeout 10 0**).

Mode Line Configuration

Usage notes This command is used set the time the telnet session waits for an idle VTY session, before it times out. An **exec-timeout 0 0** setting will cause the telnet session to wait indefinitely. The command **exec-timeout 0 0** is useful while configuring a device, but reduces device security.

If no input is detected during the interval then the current connection resumes. If no connections exist then the terminal returns to an idle state and disconnects incoming sessions.

Examples To set VTY connections to timeout after 2 minutes, 30 seconds if there is no response from the user, use the following commands:

```
awplus# configure terminal
awplus(config)# line vty 0 32
awplus(config-line)# exec-timeout 2 30
```

To reset the console connection to the default timeout of 10 minutes 0 seconds if there is no response from the user, use the following commands:

```
awplus# configure terminal
awplus(config)# line console 0
awplus(config-line)# no exec-timeout
```

Related commands

- line
- service telnet
- show running-config

flowcontrol hardware (asyn/console)

Overview Use this command to enable RTS/CTS (Ready To Send/Clear To Send) hardware flow control on a terminal console line (asyn port) between the DTE (Data Terminal Equipment) and the DCE (Data Communications Equipment).

Syntax `flowcontrol hardware`
`no flowcontrol hardware`

Mode Line Configuration

Default Hardware flow control is disabled by default.

Usage notes Hardware flow control makes use of the RTS and CTS control signals between the DTE and DCE where the rate of transmitted data is faster than the rate of received data. Flow control is a technique for ensuring that a transmitting entity does not overwhelm a receiving entity with data. When the buffers on the receiving device are full, a message is sent to the sending device to suspend the transmission until the data in the buffers has been processed.

Hardware flow control can be configured on terminal console lines (e.g. asyn0). For Reverse Telnet connections, hardware flow control must be configured to match on both the Access Server and the Remote Device. For terminal console sessions, hardware flow control must be configured to match on both the DTE and the DCE. Settings are saved in the running configuration. Changes are applied after reboot, clear line console, or after closing the session.

Use **show running-config** and **show startup-config** commands to view hardware flow control settings that take effect after reboot for a terminal console line. See the **show running-config** command output:

```
awplus#show running-config
!
line con 1
  speed 9600
  mode out 2001
  flowcontrol hardware
!
```

Note that line configuration commands do not take effect immediately. Line configuration commands take effect after one of the following commands or events:

- issuing a [clear line console](#) command
- issuing a [reboot](#) command
- logging out of the current session

Examples To enable hardware flow control on terminal console line asyn0, use the commands:

```
awplus# configure terminal
awplus(config)# line console 0
awplus(config-line)# flowcontrol hardware
```

To disable hardware flow control on terminal console line asyn0, use the commands:

```
awplus# configure terminal
awplus(config)# line console 0
awplus(config-line)# no flowcontrol hardware
```

Related commands

- [clear line console](#)
- [show running-config](#)
- [speed \(asyn\)](#)

length (asyn)

Overview Use this command to specify the number of rows of output that the device will display before pausing, for the console or VTY line that you are configuring.

The **no** variant of this command restores the length of a line (terminal session) attached to a console port or to a VTY to its default length of 22 rows.

Syntax length <0-512>
no length

Parameter	Description
<0-512>	Number of lines on screen. Specify 0 for no pausing.

Mode Line Configuration

Default The length of a terminal session is 22 rows. The **no length** command restores the default.

Usage notes If the output from a command is longer than the length of the line the output will be paused and the ‘-More-’ prompt allows you to move to the next screen full of data.

A length of 0 will turn off pausing and data will be displayed to the console as long as there is data to display.

Examples To set the terminal session length on the console to 10 rows, use the commands:

```
awplus# configure terminal
awplus(config)# line console 0
awplus(config-line)# length 10
```

To reset the terminal session length on the console to the default (22 rows), use the commands:

```
awplus# configure terminal
awplus(config)# line console 0
awplus(config-line)# no length
```

To display output to the console continuously, use the commands:

```
awplus# configure terminal
awplus(config)# line console 0
awplus(config-line)# length 0
```

Related commands [terminal resize](#)
[terminal length](#)

line

Overview Use this command to enter line configuration mode for the specified VTYS or the console. The command prompt changes to show that the device is in Line Configuration mode.

Syntax `line vty <first-line> [<last-line>]`
`line console 0`

Parameter	Description
<code><first-line></code>	<code><0-32></code> Specify the first line number.
<code><last-line></code>	<code><0-32></code> Specify the last line number.
<code>console</code>	The console terminal line(s) for local access.
<code>vty</code>	Virtual terminal for remote console access.

Mode Global Configuration

Usage notes This command puts you into Line Configuration mode. Once in Line Configuration mode, you can configure console and virtual terminal settings, including setting [speed \(asyn\)](#), [length \(asyn\)](#), [privilege level](#), and authentication ([login authentication](#)) or accounting ([accounting login](#)) method lists.

To change the console (asyn) port speed, use this **line** command to enter Line Configuration mode before using the [speed \(asyn\)](#) command. Set the console speed (Baud rate) to match the transmission rate of the device connected to the console (asyn) port on your device.

Note that line configuration commands do not take effect immediately. Line configuration commands take effect after one of the following commands or events:

- issuing a [clear line console](#) command
- issuing a [reboot](#) command
- logging out of the current session

Examples To enter Line Configuration mode in order to configure all VTYS, use the commands:

```
awplus# configure terminal
awplus(config)# line vty 0 32
awplus(config-line)#
```

To enter Line Configuration mode to configure the console (asyn 0) port terminal line, use the commands:

```
awplus# configure terminal
awplus(config)# line console 0
awplus(config-line)#
```

**Related
commands**

- accounting login
- clear line console
- clear line vty
- flowcontrol hardware (asyn/console)
- length (asyn)
- login authentication
- privilege level
- speed (asyn)

privilege level

Overview This command sets a privilege level for VTY or console connections. The configured privilege level from this command overrides a specific user's initial privilege level at the console login.

Syntax `privilege level <1-15>`

Mode Line Configuration

Usage notes You can set an intermediate CLI security level for a console user with this command by applying privilege level 7 to access all show commands in Privileged Exec and all User Exec commands. However, intermediate CLI security will not show configuration commands in Privileged Exec.

Examples To set the console connection to have the maximum privilege level, use the following commands:

```
awplus# configure terminal
awplus(config)# line console 0
awplus(config-line)# privilege level 15
```

To set all VTY connections to have the minimum privilege level, use the following commands:

```
awplus# configure terminal
awplus(config)# line vty 0 5
awplus(config-line)# privilege level 1
```

To set all VTY connections to have an intermediate CLI security level, to access all show commands, use the following commands:

```
awplus# configure terminal
awplus(config)# line vty 0 5
awplus(config-line)# privilege level 7
```

Related commands

- [enable password](#)
- [line](#)
- [show privilege](#)
- [username](#)

security-password history

Overview This command specifies the number of previous passwords that are unable to be reused. A new password is invalid if it matches a password retained in the password history.

The **no** variant of the command disables this feature.

Syntax `security-password history <0-15>`
`no security-password history`

Parameter	Description
<0-15>	The allowable range of previous passwords to match against. A value of 0 will disable the history functionality and is equivalent to the no security-password history command. If the history functionality is disabled, all users' password history is reset and all password history is lost.

Default The default history value is 0, which will disable the history functionality.

Mode Global Configuration

Examples To restrict reuse of the three most recent passwords, use the command:

```
awplus# configure terminal
awplus(config)# security-password history 3
```

To allow the reuse of recent passwords, use the command:

```
awplus# configure terminal
awplus(config)# no security-password history
```

Related commands

- [security-password forced-change](#)
- [security-password lifetime](#)
- [security-password min-lifetime-enforce](#)
- [security-password minimum-categories](#)
- [security-password minimum-length](#)
- [security-password reject-expired-pwd](#)
- [security-password warning](#)
- [show running-config security-password](#)
- [show security-password configuration](#)
- [show security-password user](#)

security-password forced-change

Overview This command specifies whether or not a user is forced to change an expired password at the next login. If this feature is enabled, users whose passwords have expired are forced to change to a password that must comply with the current password security rules at the next login.

Note that to use this command, the lifetime feature must be enabled with the [security-password lifetime](#) command and the reject-expired-pwd feature must be disabled with the [security-password reject-expired-pwd](#) command.

The **no** variant of the command disables this feature.

Syntax `security-password forced-change`
`no security-password forced-change`

Default The forced-change feature is disabled by default.

Mode Global Configuration

Example To force a user to change their expired password at the next login, use the command:

```
awplus# configure terminal
awplus(config)# security-password forced-change
```

Related commands

- [security-password history](#)
- [security-password lifetime](#)
- [security-password min-lifetime-enforce](#)
- [security-password minimum-categories](#)
- [security-password minimum-length](#)
- [security-password reject-expired-pwd](#)
- [security-password warning](#)
- [show running-config security-password](#)
- [show security-password configuration](#)
- [show security-password user](#)

security-password lifetime

Overview This command enables password expiry by specifying a password lifetime in days.

Note that when the password lifetime feature is disabled, it also disables the [security-password forced-change](#) command and the [security-password warning](#) command.

The **no** variant of the command disables this feature.

Syntax `security-password lifetime <0-1000>`
`no security-password lifetime`

Parameter	Description
<code><0-1000></code>	Password lifetime specified in days. A value of 0 will disable lifetime functionality and the password will never expire. This is equivalent to the no security-password lifetime command.

Default The default password lifetime is 0, which will disable the lifetime functionality.

Mode Global Configuration

Example To configure the password lifetime to 10 days, use the command:

```
awplus# configure terminal
awplus(config)# security-password lifetime 10
```

Related commands

- [security-password forced-change](#)
- [security-password history](#)
- [security-password min-lifetime-enforce](#)
- [security-password minimum-categories](#)
- [security-password minimum-length](#)
- [security-password reject-expired-pwd](#)
- [security-password warning](#)
- [show running-config security-password](#)
- [show security-password configuration](#)
- [show security-password user](#)

security-password min-lifetime-enforce

Overview Use this command to configure a minimum number of days before a password can be changed by a user. With this feature enabled, once a user sets the password, the user cannot change it again until the minimum lifetime has passed.

Use the **no** variant of this command to remove the minimum lifetime.

Syntax `security-password min-lifetime-enforce <0-1000>`
`no security-password min-lifetime-enforce`

Parameter	Description
<code><0-1000></code>	The minimum number of days before a password can be changed

Default By default, no minimum lifetime is enforced.

Mode Global Configuration

Usage notes The minimum lifetime is helpful in conjunction with a security policy that prevents people from re-using old passwords. For example, if you do not allow people to re-use any of their last 5 passwords, a person can bypass that restriction by changing their password 5 times in quick succession and then re-setting it to their previous password. The minimum lifetime prevents that by preventing people from changing their password in quick succession.

Example To force users to wait at least 2 days between changing passwords, use the command:

```
awplus(config)# security-password min-lifetime-enforce 2
```

Related commands

- [security-password forced-change](#)
- [security-password history](#)
- [security-password lifetime](#)
- [security-password minimum-categories](#)
- [security-password minimum-length](#)
- [security-password reject-expired-pwd](#)
- [security-password warning](#)
- [show running-config security-password](#)
- [show security-password configuration](#)
- [show security-password user](#)

Command changes Version 5.4.7-0.2: command added

security-password minimum-categories

Overview This command specifies the minimum number of categories that the password must contain in order to be considered valid. The password categories are:

- uppercase letters: A to Z
- lowercase letters: a to z
- digits: 0 to 9
- special symbols: all printable ASCII characters not included in the previous three categories. The question mark (?) cannot be used as it is reserved for help functionality.

Note that to ensure password security, the minimum number of categories should align with the lifetime selected, i.e. the fewer categories specified the shorter the lifetime specified.

Syntax `security-password minimum-categories <1-4>`

Parameter	Description
<1-4>	Number of categories the password must satisfy, in the range 1 to 4.

Default The default number of categories that the password must satisfy is 1.

Mode Global Configuration

Example To configure the required minimum number of character categories to be 3, use the command:

```
awplus# configure terminal
awplus(config)# security-password minimum-categories 3
```

Related commands

- [security-password forced-change](#)
- [security-password history](#)
- [security-password lifetime](#)
- [security-password min-lifetime-enforce](#)
- [security-password minimum-length](#)
- [security-password reject-expired-pwd](#)
- [security-password warning](#)
- [show running-config security-password](#)
- [show security-password configuration](#)
- [show security-password user](#)

security-password minimum-length

Overview This command specifies the minimum allowable password length. This value is checked against when there is a password change or a user account is created.

Syntax `security-password minimum-length <1-23>`

Parameter	Description
<1-23>	Minimum password length in the range from 1 to 23.

Default The default minimum password length is 1.

Mode Global Configuration

Example To configure the required minimum password length as 8, use the command:

```
awplus# configure terminal
awplus(config)# security-password minimum-length 8
```

Related commands

- [security-password forced-change](#)
- [security-password history](#)
- [security-password lifetime](#)
- [security-password min-lifetime-enforce](#)
- [security-password minimum-categories](#)
- [security-password reject-expired-pwd](#)
- [security-password warning](#)
- [show running-config security-password](#)
- [show security-password configuration](#)
- [show security-password user](#)

security-password reject-expired-pwd

Overview This command specifies whether or not a user is allowed to login with an expired password. Users with expired passwords are rejected at login if this functionality is enabled. Users then have to contact the Network Administrator to change their password.

CAUTION: *Once all users' passwords are expired you are unable to login to the device again if the security-password reject-expired-pwd command has been executed. You will have to reboot the device with a default configuration file, or load an earlier software version that does not have the security password feature.*

We recommend you never have the command line "security-password reject-expired-pwd" in a default config file.

Note that when the reject-expired-pwd functionality is disabled and a user logs on with an expired password, if the forced-change feature is enabled with [security-password forced-change](#) command, a user may have to change the password during login depending on the password lifetime specified by the [security-password lifetime](#) command.

The **no** variant of the command disables this feature.

Syntax security-password reject-expired-pwd
no security-password reject-expired-pwd

Default The reject-expired-pwd feature is disabled by default.

Mode Global Configuration

Example To configure the system to reject users with an expired password, use the command:

```
awplus# configure terminal
awplus(config)# security-password reject-expired-pwd
```

Related commands

- [security-password forced-change](#)
- [security-password history](#)
- [security-password lifetime](#)
- [security-password min-lifetime-enforce](#)
- [security-password minimum-categories](#)
- [security-password minimum-length](#)
- [security-password warning](#)
- [show running-config security-password](#)
- [show security-password configuration](#)
- [show security-password user](#)

security-password warning

Overview This command specifies the number of days before the password expires that the user will receive a warning message specifying the remaining lifetime of the password.

Note that the warning period cannot be set unless the lifetime feature is enabled with the [security-password lifetime](#) command.

The **no** variant of the command disables this feature.

Syntax `security-password warning <0-1000>`
`no security-password warning`

Parameter	Description
<0-1000>	Warning period in the range from 0 to 1000 days. A value 0 disables the warning functionality and no warning message is displayed for expiring passwords. This is equivalent to the no security-password warning command. The warning period must be less than, or equal to, the password lifetime set with the security-password lifetime command.

Default The default warning period is 0, which disables warning functionality.

Mode Global Configuration

Example To configure a warning period of three days, use the command:

```
awplus# configure terminal
awplus(config)# security-password warning 3
```

Related commands

- [security-password forced-change](#)
- [security-password history](#)
- [security-password lifetime](#)
- [security-password min-lifetime-enforce](#)
- [security-password minimum-categories](#)
- [security-password minimum-length](#)
- [security-password reject-expired-pwd](#)
- [show running-config security-password](#)
- [show security-password configuration](#)
- [show security-password user](#)

service advanced-vty

Overview This command enables the advanced-vty help feature. This allows you to use TAB completion for commands. Where multiple options are possible, the help feature displays the possible options.

The **no service advanced-vty** command disables the advanced-vty help feature.

Syntax service advanced-vty
no service advanced-vty

Default The advanced-vty help feature is enabled by default.

Mode Global Configuration

Examples To disable the advanced-vty help feature, use the command:

```
awplus# configure terminal  
awplus(config)# no service advanced-vty
```

To re-enable the advanced-vty help feature after it has been disabled, use the following commands:

```
awplus# configure terminal  
awplus(config)# service advanced-vty
```

service password-encryption

Overview Use this command to enable password encryption. This is enabled by default. When password encryption is enabled, the device displays passwords in the running config in encrypted form instead of in plain text.

Use the **no service password-encryption** command to stop the device from displaying newly-entered passwords in encrypted form. This does not change the display of existing passwords.

Syntax `service password-encryption`
`no service password-encryption`

Mode Global Configuration

Example `awplus# configure terminal`
`awplus(config)# service password-encryption`

Validation Commands `show running-config`

Related commands `enable password`

service telnet

Overview Use this command to enable the telnet server. The server is enabled by default. Enabling the telnet server starts the device listening for incoming telnet sessions on the configured port.

The server listens on port 23, unless you have changed the port by using the [privilege level](#) command.

Use the **no** variant of this command to disable the telnet server. Disabling the telnet server will stop the device listening for new incoming telnet sessions. However, existing telnet sessions will still be active.

Syntax `service telnet [ip|ipv6]`
`no service telnet [ip|ipv6]`

Default The IPv4 and IPv6 telnet servers are enabled by default.
The configured telnet port is TCP port 23 by default.

Mode Global Configuration

Examples To enable both the IPv4 and IPv6 telnet servers, use the following commands:

```
awplus# configure terminal
awplus(config)# service telnet
```

To enable the IPv6 telnet server only, use the following commands:

```
awplus# configure terminal
awplus(config)# service telnet ipv6
```

To disable both the IPv4 and IPv6 telnet servers, use the following commands:

```
awplus# configure terminal
awplus(config)# no service telnet
```

To disable the IPv6 telnet server only, use the following commands:

```
awplus# configure terminal
awplus(config)# no service telnet ipv6
```

Related commands

- [clear line vty](#)
- [show telnet](#)
- [telnet server](#)

show aaa local user locked

Overview This command displays the current number of failed attempts, last failure time and location against each user account attempting to log into the device.

Note that once the lockout count has been manually cleared by another privileged account using the [clear aaa local user lockout](#) command or a locked account successfully logs into the system after waiting for the lockout time, this command will display nothing for that particular account.

Syntax `show aaa local user locked`

Mode User Exec and Privileged Exec

Example To display the current failed attempts for local users, use the command:

```
awplus# show aaa local user locked
```

Output Figure 4-1: Example output from the **show aaa local user locked** command

```
awplus# show aaa local user locked
Login          Failures Latest failure      From
bob            3      05/23/14 16:21:37  ttyS0
manager        5      05/23/14 16:31:44  192.168.1.200
```

Related commands

- [aaa local authentication attempts lockout-time](#)
- [aaa local authentication attempts max-fail](#)
- [clear aaa local user lockout](#)

show privilege

Overview This command displays the current user privilege level, which can be any privilege level in the range <1-15>. Privilege levels <1-6> allow limited user access (all User Exec commands), privilege levels <7-14> allow restricted user access (all User Exec commands plus Privileged Exec show commands). Privilege level 15 gives full user access to all Privileged Exec commands.

Syntax `show privilege`

Mode User Exec and Privileged Exec

Usage notes A user can have an intermediate CLI security level set with this command for privilege levels <7-14> to access all show commands in Privileged Exec mode and all commands in User Exec mode, but no configuration commands in Privileged Exec mode.

Example To show the current privilege level of the user, use the command:

```
awplus# show privilege
```

Output Figure 4-2: Example output from the **show privilege** command

```
awplus#show privilege
Current privilege level is 15
awplus#disable
awplus>show privilege
Current privilege level is 1
```

Related commands [privilege level](#)

show security-password configuration

Overview This command displays the configuration settings for the various security password rules.

Syntax `show security-password configuration`

Mode Privileged Exec

Example To display the current security-password rule configuration settings, use the command:

```
awplus# show security-password configuration
```

Output Figure 4-3: Example output from the **show security-password configuration** command

```
Security Password Configuration
Minimum password length ..... 8
Minimum password character categories to match ..... 3
Number of previously used passwords to restrict..... 4
Password lifetime ..... 30 day(s)
  Warning period before password expires ..... 3 day(s)
Reject expired password at login ..... Disabled
  Force changing expired password at login ..... Enabled
```

- Related commands**
- [security-password forced-change](#)
 - [security-password history](#)
 - [security-password lifetime](#)
 - [security-password min-lifetime-enforce](#)
 - [security-password minimum-categories](#)
 - [security-password minimum-length](#)
 - [security-password reject-expired-pwd](#)
 - [security-password warning](#)
 - [show security-password user](#)

show security-password user

Overview This command displays user account and password information for all users.

Syntax `show security-password user`

Mode Privileged Exec

Example To display the system users' remaining lifetime or last password change, use the command:

```
awplus# show security-password user
```

Output Figure 4-4: Example output from the **show security-password** user command

User account and password information			
UserName	Privilege	Last-PWD-Change	Remaining-lifetime
manager	15	4625 day(s) ago	No Expiry
bob15	15	0 day(s) ago	30 days
ted7	7	0 day(s) ago	No Expiry
mike1	1	0 day(s) ago	No Expiry

- Related commands**
- [security-password forced-change](#)
 - [security-password history](#)
 - [security-password lifetime](#)
 - [security-password min-lifetime-enforce](#)
 - [security-password minimum-categories](#)
 - [security-password minimum-length](#)
 - [security-password reject-expired-pwd](#)
 - [security-password warning](#)
 - [show security-password configuration](#)

show telnet

Overview This command shows the Telnet server settings.

Syntax `show telnet`

Mode User Exec and Privileged Exec

Example To show the Telnet server settings, use the command:

```
awplus# show telnet
```

Output Figure 4-5: Example output from the **show telnet** command

```
Telnet Server Configuration
-----
Telnet server           : Enabled
Protocol                : IPv4, IPv6
Port                    : 23
```

Related commands

- [clear line vty](#)
- [service telnet](#)
- [show users](#)
- [telnet server](#)

show users

Overview This command shows information about the users who are currently logged into the device.

Syntax `show users`

Mode User Exec and Privileged Exec

Example To show the users currently connected to the device, use the command:

```
awplus# show users
```

Output Figure 4-6: Example output from the **show users** command

Line	User	Host(s)	Idle	Location	Priv	Idletime	Timeout
con 0	manager	idle	00:00:00	ttyS0	15	10	N/A
vtty 0	bob	idle	00:00:03	172.16.11.3	1	0	5

Table 1: Parameters in the output of the **show users** command

Parameter	Description
Line	Console port user is connected to.
User	Login name of user.
Host(s)	Status of the host the user is connected to.
Idle	How long the host has been idle.
Location	URL location of user.
Priv	The privilege level in the range 1 to 15, with 15 being the highest.
Idletime	The time interval the device waits for user input from either a console or VTY connection.
Timeout	The time interval before a server is considered unreachable.

telnet

Overview Use this command to open a telnet session to a remote device.

Syntax `telnet {<hostname>|[ip] <ipv4-addr>|[ipv6] <ipv6-addr>} [
<port>]`

Syntax (VRF-lite) `telnet [vrf <vrf-name>] {<hostname>|[ip] <ipv4-addr>|[ipv6] <ipv6-addr>} [
<port>]`

Parameter	Description
vrf	Apply this command to a VRF instance.
<vrf-name>	The name of the VRF instance.
<hostname>	The host name of the remote system.
ip	Keyword used to specify the IPv4 address or host name of a remote system.
<ipv4-addr>	An IPv4 address of the remote system.
ipv6	Keyword used to specify the IPv6 address of a remote system
<ipv6-addr>	Placeholder for an IPv6 address in the format x:x::x:x, for example, 2001:db8::8a2e:7334
<port>	Specify a TCP port number (well known ports are in the range 1-1023, registered ports are 1024-49151, and private ports are 49152-65535).

Mode User Exec and Privileged Exec

Examples To connect to TCP port 2602 on the device at 10.2.2.2, use the command:

```
awplus# telnet 10.2.2.2 2602
```

To connect to the telnet server `host.example`, use the command:

```
awplus# telnet host.example
```

To connect to the telnet server `host.example` on TCP port 100, use the command:

```
awplus# telnet host.example 100
```

Example (VRF-lite) To open a telnet session to a remote host 192.168.0.1 associated with VRF instance `red`, use the command:

```
awplus# telnet vrf red ip 192.168.0.1
```

Command changes Version 5.4.6-2.1: VRF-lite support added.

telnet server

Overview This command enables the telnet server on the specified TCP port. If the server is already enabled then it will be restarted on the new port. Changing the port number does not affect the port used by existing sessions.

Syntax `telnet server {<1-65535>|default}`

Parameter	Description
<1-65535>	The TCP port to listen on.
default	Use the default TCP port number 23.

Mode Global Configuration

Example To enable the telnet server on TCP port 2323, use the following commands:

```
awplus# configure terminal
awplus(config)# telnet server 2323
```

Related commands [show telnet](#)

terminal length

Overview Use the **terminal length** command to specify the number of rows of output that the device will display before pausing, for the currently-active terminal only.

Use the **terminal no length** command to remove the length specified by this command. The default length will apply unless you have changed the length for some or all lines by using the [length \(asyn\)](#) command.

Syntax `terminal length <length>`
`terminal no length [<length>]`

Parameter	Description
<code><length></code>	<code><0-512></code> Number of rows that the device will display on the currently-active terminal before pausing.

Mode User Exec and Privileged Exec

Examples The following example sets the number of lines to 15:

```
awplus# terminal length 15
```

The following example removes terminal length set previously:

```
awplus# terminal no length
```

Related commands [terminal resize](#)
[length \(asyn\)](#)

terminal resize

Overview Use this command to automatically adjust the number of rows of output on the console, which the device will display before pausing, to the number of rows configured on the user's terminal.

Syntax `terminal resize`

Mode User Exec and Privileged Exec

Usage notes When the user's terminal size is changed, then a remote session via SSH or TELNET adjusts the terminal size automatically. However, this cannot normally be done automatically for a serial or console port. This command automatically adjusts the terminal size for a serial or console port.

Examples The following example automatically adjusts the number of rows shown on the console:

```
awplus# terminal resize
```

Related commands [length \(asyn\)](#)
[terminal length](#)

username

Overview This command creates or modifies a user to assign a privilege level and a password.

NOTE: *The default username privilege level of 1 is not shown in running-config output. Any username privilege level that has been modified from the default is shown.*

Syntax

```
username <name> privilege <1-15> [password [8] <password>]
username <name> password [8] <password>
no username <name>
```

Parameter	Description
<name>	The login name for the user. Do not use punctuation marks such as single quotes ('), double quotes ("), or colons (:) with the user login name.
privilege	The user's privilege level. Use the privilege levels to set the access rights for each user.
<1-15>	A privilege level: either 1-14 (limited access) or 15 (full access). A user with privilege level 1-14 can only access higher privilege levels if an enable password has been configured for the level the user tries to access and the user enters that password. A user at privilege level 1 can access the majority of show commands. A user at privilege level 7 can access the majority of show commands including platform show commands. Privilege Level 15 (to access the Privileged Exec command mode) is required to access configuration commands as well as show commands in Privileged Exec.
password	A password that the user must enter when logging in.
8	The parameter 8 means that the password that follows is in hashed form, not plain text. Do not type this 8 when creating a password with this command; it is only used in configuration files. In configuration files, the device prints 8 in front of passwords, to indicate that it is displaying the password in its hashed form. Note that the user needs to enter the plain-text version of the password when logging in.
<password>	The user's password. The password can be up to 32 characters in length and include characters from up to four categories. The password categories are: <ul style="list-style-type: none"> uppercase letters: A to Z lowercase letters: a to z digits: 0 to 9 special symbols: all printable ASCII characters not included in the previous three categories. The question mark ? cannot be used as it is reserved for help functionality.

Mode Global Configuration

Default The privilege level is 1 by default. Note the default is not shown in running-config output.

Usage notes An intermediate CLI security level (privilege level 7 to privilege level 14) allows a CLI user access to the majority of show commands, including the platform show commands that are available at privilege level 1 to privilege level 6. Note that some show commands, such as **show running-configuration** and **show startup-configuration**, are only available at privilege level 15.

Examples To create the user "bob" with a privilege level of 15, for all show commands including show running-configuration and show startup-configuration and to access configuration commands in Privileged Exec command mode, and the password "bobs_secret", use the commands:

```
awplus# configure terminal
awplus(config)# username bob privilege 15 password bobs_secret
```

To create a user "junior_admin" with a privilege level of 7, which will have intermediate CLI security level access for most show commands, and the password "show_only", use the commands:

```
awplus# configure terminal
awplus(config)# username junior_admin privilege 7 password
show_only
```

Related commands

- [enable password](#)
- [security-password minimum-categories](#)
- [security-password minimum-length](#)

5

Update Manager Commands

Introduction

Overview This chapter provides an alphabetical reference of commands used to update a resource. For more information, see the [Update Manager Feature Overview and Configuration_Guide](#).

- Command List**
- “[show resource](#)” on page 248
 - “[update now](#)” on page 249
 - “[update webgui now](#)” on page 250

show resource

Overview Use this command to show information about the resources of features that have been enabled.

Syntax `show resource [<resource-name>]`

Parameter	Description
<code><resource-name></code>	Specific resource to show

Mode Privileged Exec

Examples To show information about the resources of features that have been enabled, use the following command:

```
awplus# show resource
```

Output Figure 5-1: Example output for **show resource**

```
awplus#show resource
```

Resource Name	Status	Version	Interval	Last Download	Next Download Check
iprep_et_rules	Checking	1.1	4 hours	Wed Dec 31 23:59:00 2020	Thu Jan 1 01:00:00 2020

The parameters in the example output are explained in the following table.

Parameter	Description
Resource Name	Name of the updatable resource
Status	Resource status. There are five types of status: Sleeping, Checking, Starting, Downloading, Stopping.
Version	Current version of the resource
Interval	Configured update check interval for the resource
Last Download	Time stamp of last resource downloaded
Next Download Check	Time stamp of next download check for the resource

Related commands [update now](#)
[update webgui now](#)

Command changes Version 5.4.9-2.1: command added to SBx908 GEN2

update now

Overview Use this command to immediately perform a resource update check and update the specified resource if a newer version is available.

Syntax `update {<resource-name>|all} now`

Parameter	Description
<code><resource-name></code>	Specific resource to update. You will get an error message if the resource does not exist.
<code>all</code>	Update all resources

Mode Privileged Exec

Usage notes The default update interval for a resource is 1 hour. Users can initiate an immediate update check for a resource at any time without affecting any configured update check schedule. The Update Manager will perform an update check for a resource when triggered to do so. The Update Manager will request the current version number of the resource from the Update Server, then compare it with the current local version. If they are different, the Update Manager will initiate an update of the local resource.

Note that if a feature is disabled, regular and manual update checks for its resources are also disabled.

Also note that an update check for a resource will not proceed if an update of that resource is already in progress.

The Update Manager will retry upon failure to download a resource file because of DNS resolution error, bad checksum and so on.

Examples To do an update check and update all available resources, use the following command:

```
awplus# update all now
```

To do an update check and update the device's GUI, use the following command:

```
awplus# update webgui now
```

Related commands [show resource](#)
[update webgui now](#)

Command changes Version 5.4.9-2.1: command added to SBx908 GEN2

update webgui now

Overview Use this command to check whether you have the latest version of the device's GUI and update it if a newer version is available.

Syntax `update webgui now`

Mode Privileged Exec

Usage notes If you have previously used the **copy** command to copy GUI files onto your device, these files need to be deleted before running **update webgui now**. To delete all GUI files, use the command:

```
awplus# del *gui_*.tar.gz
```

Examples To check for GUI updates, use the following command:

```
awplus# update webgui now
```

Related commands [show resource](#)

Command changes Version 5.4.9-2.1: command added to SBx908 GEN2

6

Web Redirect Commands

Introduction

Overview This chapter provides an alphabetical reference of commands used to configure Web Redirect.

The Web Redirect feature monitors HTTP requests passing through a device, intercepts the request, and replies with an HTTP Redirect message instructing the client to go to a specified URL.

For more information, see the [Web Redirect Feature Overview and Configuration Guide](#).

- Command List**
- [“browser-only \(web-redirect\)”](#) on page 252
 - [“enable \(web-redirect\)”](#) on page 253
 - [“exclude app”](#) on page 254
 - [“exclude dst-ip”](#) on page 256
 - [“exclude ip”](#) on page 258
 - [“exclude mac”](#) on page 259
 - [“exclude url”](#) on page 260
 - [“idle-time \(web-redirect\)”](#) on page 262
 - [“mode \(web-redirect\)”](#) on page 264
 - [“proxy-host \(web-redirect\)”](#) on page 266
 - [“repeat-time \(web-redirect\)”](#) on page 268
 - [“server-url \(web-redirect\)”](#) on page 269
 - [“show running-config web-redirect”](#) on page 270
 - [“show web-redirect”](#) on page 271
 - [“web-redirect”](#) on page 272

browser-only (web-redirect)

Overview Use this command to redirect only the HTTP requests sent by a web browser.
Use the **no** variant of this command to redirect all HTTP requests.

Syntax browser-only
no browser-only

Default Disabled.

Mode Web Redirect Configuration

Usage notes Hosts may be using HTTP to request automatic software updates but it may be inappropriate for these requests to be redirected.

The **browser-only** option identifies browser requests by the "Mozilla" string in the User-Agent field of the HTTP request. If the string is not present the request is not redirected. All common browsers include "Mozilla" in their User-Agent field.

Example To redirect only web browser HTTP clients, use the following commands:

```
awplus# configure terminal
awplus(config)# web-redirect
awplus(config-web-redirect)# browser-only
```

To redirect all HTTP clients, use the following commands:

```
awplus# configure terminal
awplus(config)# web-redirect
awplus(config-web-redirect)# no browser-only
```

Related commands [web-redirect](#)

Command changes Version 5.4.8-1.1: command added

enable (web-redirect)

Overview Use this command to enable web redirection on a device.

Use the **no** variant of this command to disable web redirection without losing any existing web redirection configuration.

Syntax enable
no enable

Default Disabled.

Mode Web Redirect Configuration

Usage notes The web redirect feature monitors HTTP requests passing through a device, intercepts the request, and replies with an HTTP Redirect message instructing the client to go to a specified URL.

Example To enable web redirection, use the following commands:

```
awplus# configure terminal
awplus(config)# web-redirect
awplus(config-web-redirect)# enable
```

To disable web redirection, use the following commands:

```
awplus# configure terminal
awplus(config)# web-redirect
awplus(config-web-redirect)# no enable
```

Related commands [web-redirect](#)

Command changes Version 5.4.8-1.1: command added

exclude app

Overview Use this command to prevent web redirection from redirecting flows from a specified application.

Use the **no** variant of this command to remove an application-based exclusion.

Syntax `exclude app <application-name>`
`no exclude app <application-name>`

Parameter	Description
<code><application-name></code>	The application name.

Default Disabled

Mode Web Redirect Configuration

Usage notes In **proxy** mode, web redirection forwards all HTTP/HTTPS traffic to an upstream proxy server. You can use this command in proxy mode to exempt low security risk traffic from web redirection and send it directly to the Internet. This reduces the load on the proxy server.

Example To prevent the office365 application from having web-redirection applied, first set the **mode** to **proxy**:

```
awplus# configure terminal
awplus(config)# web-redirect
awplus(config-web-redirect)# mode proxy
```

Then configure the **proxy-host** server address and port:

```
awplus(config-web-redirect)# proxy-host 192.168.1.1 port 80
```

Finally use the **exclude app** command:

```
awplus(config-web-redirect)# exclude app office365
```

To remove this exclusion, use the command:

```
awplus(config-web-redirect)# no exclude app office365
```

Related commands [browser-only \(web-redirect\)](#)

[exclude dst-ip](#)

[exclude ip](#)

[exclude mac](#)

[exclude url](#)

[web-redirect](#)

Command changes Version 5.5.0-2.3: command added

exclude dst-ip

Overview Use this command to prevent web redirection from redirecting flows that have a specified destination IP address or network. You can use this to avoid redirecting requests for a particular server.

Use the **no** variant of this command to remove a destination IP address-based exclusion.

Syntax `exclude dst-ip`
`{<ip-address>|<ip-subnet>|<ipv6-address>|<ipv6-prefix>}`
`no exclude dst-ip`
`{<ip-address>|<ip-subnet>|<ipv6-address>|<ipv6-prefix>}`

Parameter	Description
<code><ip-address></code>	Exclude a specific server IP address from web redirection. Specify the address in dotted decimal format (A.B.C.D).
<code><ip-subnet></code>	Exclude a server subnet from web redirection. Specify the subnet in dotted decimal format (A.B.C.D/M).
<code><ipv6-address></code>	Exclude a specific server IPv6 address from web redirection. Specify the address in the format X:Y::Z.
<code><ipv6-prefix></code>	Exclude a server subnet from web redirection. Specify the prefix in the format X:Y::/Z.

Mode Web Redirect Configuration

Example To prevent requests to web servers in the subnet 192.168.5.0/24 from having web-redirection applied, use the commands:

```
awplus# configure terminal
awplus(config)# web-redirect
awplus(config-web-redirect)# exclude dst-ip 192.168.5.0/24
```

To remove this exclusion, use the commands:

```
awplus# configure terminal
awplus(config)# web-redirect
awplus(config-web-redirect)# no exclude dst-ip 192.168.5.0/24
```

Related commands [browser-only \(web-redirect\)](#)
[exclude app](#)
[exclude dst-ip](#)
[exclude ip](#)
[exclude mac](#)
[exclude url](#)

web-redirect

Command changes Version 5.5.2-1.1: command added

exclude ip

Overview Use this command to prevent web redirection from redirecting flows that come from a specified source IP address or network.

Use the **no** variant of this command to remove a source IP address-based exclusion.

Syntax `exclude ip {<ip-address>|<ip-subnet>}`
`no exclude ip {<ip-address>|<ip-subnet>}`

Parameter	Description
<code><ip-address></code>	Exclude a specific client IP address from web redirection
<code><ip-subnet></code>	Exclude a client subnet from web redirection

Mode Web Redirect Configuration

Example To exclude the source subnet 192.0.2.0/24 from being redirected, use the commands:

```
awplus# configure terminal
awplus(config)# web-redirect
awplus(config-web-redirect)# exclude ip 192.0.2.0/24
```

To remove this exclusion, use the commands:

```
awplus# configure terminal
awplus(config)# web-redirect
awplus(config-web-redirect)# no exclude ip 192.0.2.0/24
```

Related commands [browser-only \(web-redirect\)](#)

[exclude app](#)
[exclude dst-ip](#)
[exclude ip](#)
[exclude mac](#)
[exclude url](#)
[web-redirect](#)

Command changes Version 5.4.8-1.1: command added

exclude mac

Overview Use this command to prevent web redirection from redirecting flows from a group of MAC addresses.

Use the **no** variant of this command to remove a MAC address-based exclusion.

Syntax `exclude mac <oui>`
`no exclude mac <oui>`

Parameter	Description
<code><oui></code>	The OUI (Organizational Unique Identifier) for the MAC address to be excluded. This is the vendor component of the MAC address, the first 24 bits that uniquely identify the vendor. It is in the format aa:bb:cc.

Mode Web Redirect Configuration

Usage notes Note that MAC address exclusions will not work for IPv6-based requests.

Example To prevent Allied Telesis devices from being redirected, use the commands:

```
awplus# configure terminal
awplus(config)# web-redirect
awplus(config-web-redirect)# exclude mac 00:00:cd
```

To remove this exclusion, use the commands:

```
awplus# configure terminal
awplus(config)# web-redirect
awplus(config-web-redirect)# no exclude mac 00:00:cd
```

Related commands [browser-only \(web-redirect\)](#)

[exclude app](#)
[exclude dst-ip](#)
[exclude ip](#)
[exclude url](#)
[web-redirect](#)

Command changes Version 5.4.8-1.1: command added

exclude url

Overview Use this command to prevent web redirection from redirecting flows that are going to a specified URL or group of URLs.

Use the **no** variant of this command to remove a URL-based exclusion.

Syntax `exclude url <regex>`
`no exclude url <regex>`

Parameter	Description
<code><regex></code>	A case sensitive regular expression used to check a URL for a match. If the URL matches the regular expression it is excluded from web redirection.

Default Disabled

Mode Web Redirect Configuration

Usage notes In **proxy** mode, web redirection forwards all HTTP/HTTPS traffic to an upstream proxy server. You can use this command in proxy mode to exempt low security risk traffic from web redirection and send it directly to the Internet. This reduces the load on the proxy server.

Example To prevent all URLs containing 'example.com' from having web-redirection applied, first set the **mode** to proxy:

```
awplus# configure terminal
awplus(config)# web-redirect
awplus(config-web-redirect)# mode proxy
```

Then configure the **proxy-host** server address and port:

```
awplus(config-web-redirect)# proxy-host 192.168.1.1 port 80
```

Finally use the **exclude url** command:

```
awplus(config-web-redirect)# exclude url example.com
```

To remove the exclusion for all URLs ending with 'example.com', use the command:

```
awplus(config-web-redirect)# no exclude url example.com
```

Other examples To exclude all URLs that contain the word 'mail', use the following regular expression:

```
awplus(config-web-redirect)# exclude url mail
```

To exclude all URLs that start with 'https://', use the following regular expression:

```
awplus(config-web-redirect)# exclude url ^https://
```

To exclude a specific URL, use the following regular expression:

```
awplus(config-web-redirect)# exclude url  
^https://www.example.com/Doc/FAQ/$
```

**Related
commands**

[browser-only \(web-redirect\)](#)

[exclude app](#)

[exclude dst-ip](#)

[exclude ip](#)

[exclude mac](#)

[web-redirect](#)

**Command
changes**

Version 5.5.0-2.3: command added

idle-time (web-redirect)

Overview Use this command to set the time the client must have been idle before it can be redirected once the repeat-time has expired.

This command improves your web browsing experience. For example, if you were busy browsing a web site and loading new content, then it is undesirable to be immediately redirected after the expiry of the repeat time interval. To ensure an ideal user experience, it is better to wait for an additional period of time to ensure current web site content is fully downloaded, and for the browser to have been idle before being redirected.

Use the **no** variant of this command to revert to the default value of 0.

Syntax `idle-time <0-86400>`
`no idle-time`

Parameter	Description
<code><0-86400></code>	Idle time after repeat time before redirecting a client, in seconds.

Default 0 seconds.

Mode Web Redirect Configuration

Usage notes Sets the interval, following the repeat time, for which a client must be idle before it will be redirected again. This interval makes it likely that it will be a web page request that is redirected, rather than some sub-component of the page. This ensures the page that the user is being redirected to is displayed as a full page, rather than a sub-component of the current page being browsed to.

NOTE: *The time when the client is idle can include the time leading up to the expiry of the **repeat-time**. So, if the idle time was 60sec and the client had been idle for the 60sec prior to the repeat-time expiring, the client could be redirected straight away. Or, if it had been idle for 30sec prior to the repeat-time expiring, it would need to be idle for a further 30sec afterwards, before being redirected.*

Example To configure the time after repeat time before redirecting a client to 1 hour (3600 seconds), use the commands:

```
awplus# configure terminal
awplus(config)# web-redirect
awplus(config-web-redirect)# idle-time 3600
```

To restore the default idle time, which is 0 seconds, use the commands:

```
awplus# configure terminal
awplus(config)# web-redirect
awplus(config-web-redirect)# no idle-time
```

Related commands [web-redirect](#)
[repeat-time \(web-redirect\)](#)

Command changes Version 5.4.8-1.1: command added

mode (web-redirect)

Overview Use this command to set the Web Redirection mode.

Use the **no** variant of this command to revert to the default mode of HTTP redirection.

Syntax mode {http|proxy}
no mode

Parameter	Description
http	HTTP and HTTPS redirection. This provides a way for HTTP and HTTPS client requests to be redirected to a specified URL.
proxy	Proxy chaining redirection. In proxy chaining mode, Web Redirect forwards all HTTP/HTTPS traffic to a particular upstream explicit proxy server.

Default HTTP.

Mode Web Redirect Configuration

Example To set the web redirection to proxy chaining mode, use the commands:

```
awplus# configure terminal
awplus(config)# web-redirect
awplus(config-web-redirect)# mode proxy
```

To set the web redirection to HTTP mode, use the commands:

```
awplus# configure terminal
awplus(config)# web-redirect
awplus(config-web-redirect)# mode http
```

To restore the default web redirection, use the commands:

```
awplus# configure terminal
awplus(config)# web-redirect
awplus(config-web-redirect)# no mode
```

Related commands

- [web-redirect](#)
- [repeat-time \(web-redirect\)](#)
- [idle-time \(web-redirect\)](#)
- [server-url \(web-redirect\)](#)
- [browser-only \(web-redirect\)](#)
- [show running-config web-redirect](#)

exclude ip
exclude mac
exclude app
show web-redirect

Command changes Version 5.5.0-2.3: command added

proxy-host (web-redirect)

Overview Use this command to configure the proxy server host and port for Web Redirect in proxy chaining mode.

In proxy chaining mode, Web Redirect forwards all HTTP/HTTPS traffic to the specified upstream proxy server.

Use the **no** variant of this command to remove a configured proxy server host and port.

Syntax `proxy-host {<ipv4-address>|<ipv6-address>|<host-name>} port <0-65535>`
`no proxy-host`

Parameter	Description
<code><ipv4-address></code>	IPv4 address in dotted decimal format, for example, 192.0.2.2.
<code><ipv6-address></code>	IPv6 address in the format x:x::x:x for example, 2001:db8::8a2e:7334.
<code><host-name></code>	The host name. You can use all alphanumeric ASCII characters, and the dash (-) and underscore (_) characters. The name can be 1 to 64 characters in long.
<code>port</code>	The port number in the range of 0-65535.

Default Disabled.

Mode Web Redirect Configuration

Example To configure a proxy server host of IP address 10.1.1.1 and port number 1234, use the commands:

```
awplus# configure terminal
awplus(config)# web-redirect
awplus(config-web-redirect)# proxy-host 10.1.1.1 port 1234
```

To remove the configuration, use the commands:

```
awplus# configure terminal
awplus(config)# web-redirect
awplus(config-web-redirect)# no proxy-host
```

Related commands

- [web-redirect](#)
- [repeat-time \(web-redirect\)](#)
- [idle-time \(web-redirect\)](#)
- [server-url \(web-redirect\)](#)

browser-only (web-redirect)
show running-config web-redirect
exclude ip
exclude mac
exclude app
show web-redirect
mode (web-redirect)
exclude url

Command changes Version 5.5.0-2.3: command added

repeat-time (web-redirect)

Overview Use this command to configure the interval time between redirects for a client. Use the **no** variant of this command to revert to the default interval time.

Syntax `repeat-time <1-31536000>`
`no repeat-time`

Parameter	Description
<code><1-31536000></code>	The interval between redirects for a client in seconds.

Default 0 seconds.

Mode Web Redirect Configuration

Usage notes Sets the interval (in seconds) between redirects for a client. After the specified interval the client will be **eligible** to be redirected again. If no "repeat-time" is specified every client request will be eligible for a redirect immediately. Whether or not an eligible client is immediately redirected at the expiry of the repeat time depends on the **idle-time**.

Example To set the interval time between redirects to every hour (3600 seconds), use the commands:

```
awplus# configure terminal
awplus(config)# web-redirect
awplus(config-web-redirect)# repeat-time 3600
```

To restore the default repeat time interval time between re-directs (0 seconds), use the commands:

```
awplus# configure terminal
awplus(config)# web-redirect
awplus(config-web-redirect)# no repeat-time
```

Related commands [idle-time \(web-redirect\)](#)
[web-redirect](#)

Command changes Version 5.4.8-1.1: command added

server-url (web-redirect)

Overview Use this command to configure the URL of the server to which the HTTP connection will be redirected.

Use the **no** variant of this command to remove the configured server redirect URL.

Syntax `server-url <url>`
`no server-url`

Parameter	Description
<code><url></code>	URL (host name or dotted IP notation)

Mode Web Redirect Configuration

Example To redirect the HTTP connection to `http://redirectexample.com`, use the commands:

```
awplus# configure terminal
awplus(config)# web-redirect
awplus(config-web-redirect)# server-url
http://redirectexample.com
```

To unset the server redirect URL, use the commands:

```
awplus# configure terminal
awplus(config)# web-redirect
awplus(config-web-redirect)# no server-url
```

Related commands [web-redirect](#)

Command changes Version 5.4.8-1.1: command added

show running-config web-redirect

Overview Use this command to display the running configuration for web redirection.

Syntax `show running-config web-redirect`

Mode Privileged Exec

Example To display the running configuration for web redirection, use the following commands:

```
awplus# show running-config web-redirect
```

Output Figure 6-1: Example output from **show running-config web-redirect**

```
awplus#show running-config web-redirect
web-redirect
server-url http://redirectexample.com
repeat-time 3600
idle-time 360
enable!
```

Related commands [web-redirect](#)

Command changes Version 5.4.8-1.1: command added.

show web-redirect

Overview Use this command to display information about the status of web redirect, the total number of redirected hosts being tracked, and information about when each host (by IP) was last redirected and when it will next be eligible for redirection.

Syntax `show web-redirect`

Mode Privileged Exec

Example To show the state of web redirection, use the following command:

```
awplus# show web-redirect
```

Output Figure 6-2: Example output from **show web-redirect**

```
awplus#show web-redirect
Mode:      HTTP redirection
Status:    Enabled
Total number of redirected clients: 5
Clients:
Address                Last Redirection                Next redirection after
-----
192.0.2.0.2            Tue 22 Jun 2021 11:03:50        Wed 23 Jun 2021 11:03:50
192.0.2.0.17          Tue 22 Jun 2021 10:51:11        Wed 23 Jun 2021 10:51:11
192.0.2.0.31          Tue 22 Jun 2021 05:33:42        Wed 23 Jun 2021 05:33:42
2001:db8::2:121       Tue 22 Jun 2021 17:48:06        Wed 23 Jun 2021 17:48:06
2001:db8::1:ab6d      Tue 22 Jun 2021 01:18:39        Wed 23 Jun 2021 01:18:39
```

Related commands [web-redirect](#)

Command changes Version 5.4.8-1.1: command added

web-redirect

Overview Use this command to enter the web redirection mode so you can configure web redirection.

Use the **no** variant of this command to remove all web redirection configuration.

Syntax web-redirect
no web-redirect

Default Disabled

Mode Global Configuration

Example To configure the web redirection settings, use the commands:

```
awplus# configure terminal
awplus(config)# web-redirect
awplus(config-web-redirect)#
```

To remove all web redirection configuration, use the commands:

```
awplus# configure terminal
awplus(config)# no web-redirect
```

Related commands

- [enable \(web-redirect\)](#)
- [server-url \(web-redirect\)](#)
- [browser-only \(web-redirect\)](#)
- [exclude app](#)
- [exclude dst-ip](#)
- [exclude ip](#)
- [exclude mac](#)
- [exclude url](#)
- [show running-config web-redirect](#)
- [show web-redirect](#)

Command changes Version 5.4.8-1.1: command added

7

System Configuration and Monitoring Commands

Introduction

Overview This chapter provides an alphabetical reference of commands for configuring and monitoring the system.

- Command List**
- ["banner display external-manager"](#) on page 275
 - ["banner exec"](#) on page 276
 - ["banner external-manager"](#) on page 278
 - ["banner login \(system\)"](#) on page 280
 - ["banner motd"](#) on page 282
 - ["clock set"](#) on page 284
 - ["clock summer-time date"](#) on page 285
 - ["clock summer-time recurring"](#) on page 287
 - ["clock timezone"](#) on page 289
 - ["debug core-file"](#) on page 290
 - ["hostname"](#) on page 291
 - ["max-fib-routes"](#) on page 293
 - ["max-static-routes"](#) on page 295
 - ["no debug all"](#) on page 296
 - ["reboot"](#) on page 298
 - ["receive-packet-scheduler"](#) on page 299
 - ["reload"](#) on page 301
 - ["show banner external-manager"](#) on page 302
 - ["show clock"](#) on page 303
 - ["show cpu"](#) on page 305

- “show cpu history” on page 308
- “show debugging” on page 310
- “show interface memory” on page 311
- “show memory” on page 313
- “show memory allocations” on page 315
- “show memory history” on page 317
- “show memory pools” on page 318
- “show memory shared” on page 319
- “show process” on page 320
- “show reboot history” on page 322
- “show router-id” on page 323
- “show system” on page 324
- “show system environment” on page 325
- “show system environment counters” on page 326
- “show system interrupts” on page 328
- “show system mac” on page 329
- “show system pci device” on page 330
- “show system pci tree” on page 331
- “show system serialnumber” on page 332
- “show tech-support” on page 333
- “speed (asyn)” on page 335
- “terminal monitor” on page 337
- “undebg all” on page 338

banner display external-manager

Overview Use this command to display the external-manager banner. The external-manager banner warns you that certain features are being managed by an external management system. For example, if you are using Vista Manager EX to manage your network, you will see a notification banner telling you what features are being managed after you enter Global Configuration Mode.

Use the **no** variant of this command to hide the external-manager banner.

Syntax `banner display external-manager`
`no banner display external-manager`

Default The external-manager banner is displayed by default.

Mode User Exec

Usage notes The external-manager banner is displayed by default. In some instances it is desirable to hide it for the current session. You do this by using the **no** variant of this command. The banner will remain hidden until you either re-enable it, or log out and then log back in.

Example To hide the external-manager banner, use the command:

```
awplus> no banner display external-manager
```

To display the external-manager banner, use the command:

```
awplus> banner display external-manager
```

Related commands [banner external-manager](#)
[show banner external-manager](#)

Command changes Version 5.5.1-1.1: command added

banner exec

Overview This command configures the User Exec mode banner that is displayed on the console after you login. The **banner exec default** command restores the User Exec banner to the default banner. Use the **no banner exec** command to disable the User Exec banner and remove the default User Exec banner.

Syntax banner exec <banner-text>
banner exec default
no banner exec

Default By default, the AlliedWare Plus™ version and build date is displayed at console login, such as:

```
AlliedWare Plus (TM) 5.5.2 04/05/22 12:00:00
```

Mode Global Configuration

Examples To configure a User Exec mode banner after login (in this example, to tell people to use the **enable** command to move to Privileged Exec mode), enter the following commands:

```
awplus#configure terminal
awplus(config)#banner exec Use enable to move to Priv Exec mode
awplus(config)#exit
awplus#exit

awplus login: manager
Password:

Use enable to move to Priv Exec mode

awplus>
```

To restore the default User Exec mode banner after login, enter the following commands:

```
awplus#configure terminal
awplus(config)#banner exec default
awplus(config)#exit
awplus#exit

awplus login: manager
Password:

AlliedWare Plus (TM) 5.5.2 04/05/22 12:00:00

awplus>
```

To remove the User Exec mode banner after login, enter the following commands:

```
awplus#configure terminal
awplus(config)#no banner exec
awplus(config)#exit
awplus#exit

awplus login: manager
Password:

awplus>
```

Related commands [banner login \(system\)](#)
[banner motd](#)

banner external-manager

Overview Use this command to add an entry to the external-manager banner. The external-manager banner warns you that certain features are being managed by an external management system. For example, if you are using Vista Manager EX to manage your network, you will see a notification banner telling you what features are being managed after you enter Global Configuration Mode.

Use the **no** variant to remove an entry from the external-manager banner.

Syntax `banner external-manager <manager-name> feature <feature-name>
note <feature-note>`
`no banner external-manager <manager-name> [feature
<feature-name> note <feature-note>]`

Parameter	Description
<code><manager-name></code>	A string that describes the management system.
<code><feature-name></code>	A string that describes the feature being managed.
<code><feature-note></code>	A note for the feature.

Default No external-manager banner entries are configured by default.

Mode Global Configuration

Usage notes When you run this command:

- if no entry exists for an external manager, the external manager, feature and note are added.
- if an entry already exists for an external manager, the feature and note are added to the existing manager.
- if the feature already exists for that manager, then the note is added to the existing feature.

The **no** variant of this command removes the specified note from the feature of the specified external manager.

- If there are no other notes for the feature, then the feature is removed.
- If the feature is removed and there are no other features for the external manager, then the external manager is removed.

Use the **no** variant with just the external manager name to remove an external manager and all its features and notes.

Example To add an external manager note for 'Vista Manager' for the feature 'traffic-control' with the note 'Dynamic Traffic Management', use the commands:

```
awplus# configure terminal
awplus(config)# banner external-manager "Vista Manager" feature
"traffic-control" note "Dynamic Traffic Management"
```

To remove the external manager note 'Dynamic Traffic Management' from the feature 'traffic-control' of the external manager 'Vista Manager', use the commands:

```
awplus# configure terminal
awplus(config)# no banner external-manager "Vista Manager"
feature "traffic-control" note "Dynamic Traffic Management"
```

To remove all external manager features and notes for 'Vista Manager', use the commands:

```
awplus# configure terminal
awplus(config)# no banner external-manager "Vista Manager"
```

Related commands [banner display external-manager](#)
[show banner external-manager](#)

Command changes Version 5.5.1-1.1: command added

banner login (system)

Overview This command configures the login banner that is displayed on the console when you login. The login banner is displayed on all connected terminals. The login banner is displayed after the MOTD (Message-of-the-Day) banner and before the login username and password prompts.

Use the **no banner login** command to disable the login banner.

Syntax banner login
no banner login

Default By default, no login banner is displayed at console login.

Mode Global Configuration

Examples To configure a login banner of “Authorised users only” to be displayed when you login, enter the following commands:

```
awplus#configure terminal
awplus(config)#banner login
Type CNTL/D to finish.

Authorised users only

awplus(config)#exit
awplus#exit

Authorised users only

awplus login: manager
Password:

AlliedWare Plus (TM) 5.5.2 04/05/22 12:00:00

awplus>
```

To remove the login banner, enter the following commands:

```
awplus#configure terminal
awplus(config)#no banner login
awplus(config)#exit
awplus#exit

awplus login: manager
Password:

AlliedWare Plus (TM) 5.5.2 04/05/22 12:00:00

awplus>
```

**Related
commands** [banner exec](#)
[banner motd](#)

banner motd

Overview Use this command to create or edit the text MotD (Message-of-the-Day) banner displayed before login. The MotD banner is displayed on all connected terminals. The MotD banner is useful for sending messages that affect all network users, for example, any imminent system shutdowns.

Use the **no** variant of this command to delete the MotD banner.

Syntax banner motd *<motd-text>*
no banner motd

Parameter	Description
<i><motd-text></i>	The text to appear in the Message of the Day banner.

Default By default, the device displays the AlliedWare Plus™ OS version and build date when you login.

Mode Global Configuration

Examples To configure a MotD banner of "System shutdown at 6pm today" to be displayed when you log in, enter the following commands:

```
awplus>enable
awplus#configure terminal
Enter configuration commands, one per line. End with CNTL/Z.
awplus(config)#banner motd System shutdown at 6pm today
awplus(config)#exit
awplus#exit

System shutdown at 6pm today
awplus login: manager
Password:

AlliedWare Plus (TM) 5.5.2 04/05/22 12:00:00

awplus>
```

To delete the login banner, enter the following commands:

```
awplus>enable
awplus#configure terminal
Enter configuration commands, one per line. End with CNTL/Z.
awplus(config)#no banner motd
awplus(config)#exit
awplus#exit

awplus login: manager
Password:

AlliedWare Plus (TM) 5.5.2 04/05/22 12:00:00

awplus>
```

Related commands [banner exec](#)
[banner login \(system\)](#)

clock set

Overview This command sets the time and date for the system clock.

Syntax `clock set <hh:mm:ss> <day> <month> <year>`

Parameter	Description
<hh:mm:ss>	Local time in 24-hour format
<day>	Day of the current month, from 1 to 31
<month>	The first three letters of the current month
<year>	Current year, from 2000 to 2035

Mode Privileged Exec

Usage notes Configure the timezone before setting the local time. Otherwise, when you change the timezone, the device applies the new offset to the local time.

NOTE: *If Network Time Protocol (NTP) is enabled, then you cannot change the time or date using this command. NTP maintains the clock automatically using an external time source. If you wish to manually alter the time or date, you must first disable NTP.*

Example To set the time and date on your system to 2pm on the 2nd of October 2016, use the command:

```
awplus# clock set 14:00:00 2 oct 2016
```

Related commands [clock timezone](#)

clock summer-time date

Overview This command defines the start and end of summertime for a specific year only, and specifies summertime's offset value to Standard Time for that year.

The **no** variant of this command removes the device's summertime setting. This clears both specific summertime dates and recurring dates (set with the [clock summer-time recurring](#) command).

By default, the device has no summertime definitions set.

Syntax

```
clock summer-time <timezone-name> date <start-day>
<start-month> <start-year> <start-time> <end-day> <end-month>
<end-year> <end-time> <1-180>

no clock summer-time
```

Parameter	Description
<timezone-name>	A description of the summertime zone, up to 6 characters long.
date	Specifies that this is a date-based summertime setting for just the specified year.
<start-day>	Day that the summertime starts, from 1 to 31.
<start-month>	First three letters of the name of the month that the summertime starts.
<start-year>	Year that summertime starts, from 2000 to 2035.
<start-time>	Time of the day that summertime starts, in the 24-hour time format HH:MM.
<end-day>	Day that summertime ends, from 1 to 31.
<end-month>	First three letters of the name of the month that the summertime ends.
<end-year>	Year that summertime ends, from 2000 to 2035.
<end-time>	Time of the day that summertime ends, in the 24-hour time format HH:MM.
<1-180>	The offset in minutes.

Mode Global Configuration

Examples To set a summertime definition for New Zealand using NZST (UTC+12:00) as the standard time, and NZDT (UTC+13:00) as summertime, with the summertime set to begin on the 25th of September 2016 and end on the 2nd of April 2017:

```
awplus(config)# clock summer-time NZDT date 25 sep 2:00 2016 2
apr 2:00 2017 60
```

To remove any summertime settings on the system, use the command:

```
awplus(config)# no clock summer-time
```

Related commands [clock summer-time recurring](#)
[clock timezone](#)

clock summer-time recurring

Overview This command defines the start and end of summertime for every year, and specifies summertime's offset value to Standard Time.

The **no** variant of this command removes the device's summertime setting. This clears both specific summertime dates (set with the [clock summer-time date](#) command) and recurring dates.

By default, the device has no summertime definitions set.

Syntax

```
clock summer-time <timezone-name> recurring <start-week>
<start-day> <start-month> <start-time> <end-week> <end-day>
<end-month> <end-time> <1-180>

no clock summer-time
```

Parameter	Description
<timezone-name>	A description of the summertime zone, up to 6 characters long.
recurring	Specifies that this summertime setting applies every year from now on.
<start-week>	Week of the month when summertime starts, in the range 1-5. The value 5 indicates the last week that has the specified day in it for the specified month. For example, to start summertime on the last Sunday of the month, enter 5 for <start-week> and sun for <start-day>.
<start-day>	Day of the week when summertime starts. Valid values are mon, tue, wed, thu, fri, sat or sun.
<start-month>	First three letters of the name of the month that summertime starts.
<start-time>	Time of the day that summertime starts, in the 24-hour time format HH:MM.
<end-week>	Week of the month when summertime ends, in the range 1-5. The value 5 indicates the last week that has the specified day in it for the specified month. For example, to end summertime on the last Sunday of the month, enter 5 for <end-week> and sun for <end-day>.
<end-day>	Day of the week when summertime ends. Valid values are mon, tue, wed, thu, fri, sat or sun.
<end-month>	First three letters of the name of the month that summertime ends.
<end-time>	Time of the day that summertime ends, in the 24-hour time format HH:MM.
<1-180>	The offset in minutes.

Mode Global Configuration

Examples To set a summertime definition for New Zealand using NZST (UTC+12:00) as the standard time, and NZDT (UTC+13:00) as summertime, with summertime set to start on the last Sunday in September, and end on the 1st Sunday in April, use the command:

```
awplus(config)# clock summer-time NZDT recurring 5 sun sep 2:00  
1 sun apr 2:00 60
```

To remove any summertime settings on the system, use the command:

```
awplus(config)# no clock summer-time
```

Related commands [clock summer-time date](#)
[clock timezone](#)

clock timezone

Overview This command defines the device's clock timezone. The timezone is set as a offset to the UTC.

The **no** variant of this command resets the system time to UTC.

By default, the system time is set to UTC.

Syntax `clock timezone <timezone-name> {minus|plus}
[<0-13>|<0-12>:<00-59>]`
`no clock timezone`

Parameter	Description
<code><timezone-name></code>	A description of the timezone, up to 6 characters long.
<code>minusorplus</code>	The direction of offset from UTC. The minus option indicates that the timezone is behind UTC. The plus option indicates that the timezone is ahead of UTC.
<code><0-13></code>	The offset in hours or from UTC.
<code><0-12>:<00-59></code>	The offset in hours or from UTC.

Mode Global Configuration

Usage notes Configure the timezone before setting the local time. Otherwise, when you change the timezone, the device applies the new offset to the local time.

Examples To set the timezone to New Zealand Standard Time with an offset from UTC of +12 hours, use the command:

```
awplus(config)# clock timezone NZST plus 12
```

To set the timezone to Indian Standard Time with an offset from UTC of +5:30 hours, use the command:

```
awplus(config)# clock timezone IST plus 5:30
```

To set the timezone back to UTC with no offsets, use the command:

```
awplus(config)# no clock timezone
```

Related commands [clock set](#)
[clock summer-time date](#)
[clock summer-time recurring](#)

debug core-file

Overview Use this command to enable the generation of crash core files.
Use the **no** variant of this command to disable the generation of crash core files.

Syntax `debug core-file`
`no debug core-file`

Default Enabled.

Mode Global Configuration

Usage notes Core files may contain raw memory content. This may not be acceptable in a security certified network. Use the **no debug core-file** command to prevent such core files from being generated.

Example To prevent the generation of core files, use the commands:

```
awplus# configure terminal
awplus(config)# no debug core-file
```

Related commands [show system](#)

Command changes Version 5.4.9-1.0: command added

hostname

Overview This command sets the name applied to the device as shown at the prompt. The hostname is:

- displayed in the output of the [show system](#) command
- displayed in the CLI prompt so you know which device you are configuring
- stored in the MIB object sysName

Use the **no** variant of this command to revert the hostname setting to its default. For devices that are not part of an AMF network, the default is "awplus".

Syntax `hostname <hostname>`
`no hostname [<hostname>]`

Parameter	Description
<code><hostname></code>	Specifies the name given to a specific device.

Default `awplus`

Mode Global Configuration

Usage notes Within an AMF network, any device without a user-defined hostname will automatically be assigned a name based on its MAC address.

To efficiently manage your network using AMF, we strongly advise that you devise a naming convention for your network devices and apply an appropriate hostname to each device.

The name must also follow the rules for ARPANET host names. The name must start with a letter, end with a letter or digit, and use only letters, digits, and hyphens. Refer to RFC 1035.

Example To set the system name to `HQ-Sales`, use the command:

```
awplus# configure terminal
awplus(config)# hostname HQ-Sales
```

This changes the prompt to:

```
HQ-Sales(config)#
```

To revert to the default hostname `awplus`, use the command:

```
HQ-Sales(config)# no hostname
```

This changes the prompt to:

```
awplus(config)#
```

NOTE: When AMF is configured, running the **no hostname** command will apply a hostname that is based on the MAC address of the device node, for example, **node_0000_5e00_5301**.

Related commands [show system](#)

max-fib-routes

Overview This command enables you to control the maximum number of FIB routes configured. It operates by providing parameters that enable you to configure preset maximums and warning message thresholds.

NOTE: When using VRF-lite, this command applies to the Global VRF instance; to set the max-fib-routes for a user-defined VRF instance use the *max-fib-routes (VRF)* command. For static routes use the *max-static-routes* command for the Global VRF instance and the *max-static-routes (VRF)* command for a user-defined VRF instance.

Use the **no** variant of this command to set the maximum number of FIB routes to the default of 4294967294 FIB routes.

Syntax max-fib-routes <1-4294967294> [<1-100>|warning-only]
no max-fib-routes

Parameter	Description
max-fib-routes	This is the maximum number of routes that can be stored in the device's Forwarding Information dataBase. In practice, other practical system limits would prevent this maximum being reached.
<1-4294967294>	The allowable configurable range for setting the maximum number of FIB-routes.
<1-100>	This parameter enables you to optionally apply a percentage value. This percentage will be based on the maximum number of FIB routes you have specified. This will cause a warning message to appear when your routes reach your specified percentage value. Routes can continue to be added until your configured maximum value is reached.
warning-only	This parameter enables you to optionally apply a warning message. If you set this option a warning message will appear if your maximum configured value is reached. Routes can continue to be added until your device reaches either the maximum capacity value of 4294967294, or a practical system limit.

Default The default number of FIB routes is the maximum number of FIB routes (4294967294).

Mode Global Configuration

Examples To set the maximum number of dynamic routes to 2000 and warning threshold of 75%, use the following commands:

```
awplus# config terminal  
awplus(config)# max-fib-routes 2000 75
```

**Related
commands** [max-fib-routes \(VRF\)](#)

max-static-routes

Overview Use this command to set the maximum number of static routes, excluding FIB (Forwarding Information Base) routes.

NOTE: For FIB routes use the [max-fib-routes](#) command.

Use the **no** variant of this command to set the maximum number of static routes to the default of 1024 static routes.

Syntax `max-static-routes <1-1024>`
`no max-static-routes`

Default The default number of static routes is the maximum number of static routes (1024).

Mode Global Configuration

Example To reset the maximum number of static routes to the default maximum, use the command:

```
awplus# configure terminal
awplus(config)# no max-static-routes
```

NOTE: Static routes are applied before adding routes to the RIB (Routing Information Base). Therefore, rejected static routes will not appear in the running config.

Related commands [max-fib-routes](#)

no debug all

Overview This command disables the debugging facility for all features on your device. This stops the device from generating any diagnostic debugging messages.

You can optionally disable the debugging facility for only the given protocol or feature. The features available depend on your device and will be a subset of the features listed in the Syntax section below.

Syntax no debug all [bgp|ipv6 ospf|ipv6 rip|dot1x|nsm|ospf|pim dense-mode|pim sparse-mode|rip|vrrp]

Parameter	Description
bgp	Turns off all debugging for BGP (Border Gateway Protocol).
dot1x	Turns off all debugging for IEEE 802.1X port-based network access- control.
ipv6 ospf	Turns off all debugging for IPv6 OSPF (Open Shortest Path First).
ipv6 rip	Turns off all debugging for IPv6 RIP (Routing Information Protocol).
nsm	Turns off all debugging for the NSM (Network Services Module).
ospf	Turns off all debugging for OSPF (Open Shortest Path First).
pim dense-mode	Turns off all debugging for PIM (Protocol Independent Multicast) Dense Mode.
pim sparse-mode	Turns off all debugging for PIM (Protocol Independent Multicast) Sparse Mode.
rip	Turns off all debugging for RIP (Routing Information Protocol).
vrrp	Turns off all debugging for VRRP (Virtual Router Redundancy Protocol).

Default Disabled

Mode Global Configuration and Privileged Exec

Example To disable debugging for all features, use the command:

```
awplus# no debug all
```

To disable all BGP debugging, use the command:

```
awplus# no debug all bgp
```

To disable all NSM debugging, use the command:

```
awplus# no debug all nsm
```

To disable all OSPF debugging, use the command:

```
awplus# no debug all ospf
```

To disable all PIM Sparse Mode debugging, use the command:

```
awplus# no debug all pim sparse-mode
```

To disable all RIP debugging, use the command:

```
awplus# no debug all rip
```

To disable all VRRP debugging, use the command:

```
awplus# no debug all vrrp
```

Related commands [undebug all](#)

Command changes Version 5.4.7-1.1: **pim dense-mode**, **pim sparse-mode**, and **rip** parameters added

reboot

Overview This command halts the device and performs a cold restart (also known as reload). It displays a confirmation request before restarting.

Syntax `reboot`
`reload`

Mode Privileged Exec

Usage notes The **reboot** and **reload** commands perform the same action.

Examples To restart the device, use the command:

```
awplus# reboot
reboot system? (y/n): y
```

receive-packet-scheduler

Overview Use this command to configure a scheduling scheme that distributes packets to individual cores in a multi-core CPU.

Receive Packet Scheduling is the mechanism by which packets requiring software forwarding are distributed to individual cores in multi-core CPUs.

Use the **no** variant of this command to set the scheduling scheme back to the default of hash.

Syntax `receive-packet-scheduler {hash|balanced|split}`
`no receive-packet-scheduler`

Parameter	Description
hash	Hardware 5-Tuple flow hash-based packet core scheduling. This is the most suitable scheduling scheme for all scenarios.
balanced	Packets are balanced across cores as efficiently as possible providing the best performance for single flow scenarios.
split	Half of the CPU cores in a multi-core device are reserved for packet processing. These cores process packets using the default hash-based scheme. The other half of the processing cores are reserved for the IPsec encryption/decryption process.

Default Hash.

Mode Global Configuration

Usage notes Receive Packet Scheduling is the mechanism by which packets requiring software forwarding are distributed to individual cores in multi-core CPUs.

AlliedWare Plus uses a flow hash based scheme to ensure packets from the same flow are processed in order on the same core. This is generally accepted as the best compromise between efficiency and stability for most network traffic.

There are however a few scenarios where a different mechanism may be required. Use this command to configure alternative packet scheduling algorithms to suit your traffic patterns.

NOTE: *It is very unlikely that there would be any need to change from the default receive-packet-scheduling scheme (hash) as it is the most suitable mechanism for real network traffic.*

CAUTION: *Changing the receive packet scheduling may require IPsec SA's to be processed on a different CPU core. Hence if there are active IPsec SA's when the scheme is changed they may no longer operate correctly. All active SA's can be reset using the **clear isakmp sa** command.*

Example To configure the receive packet scheduling scheme to **split**, use the following commands:

```
awplus# configure terminal  
awplus(config)# receive-packet-scheduler split
```

To set the receive packet scheduling back to the default of **hash**, use the following commands:

```
awplus# configure terminal  
awplus(config)# no receive-packet-scheduler
```

Related commands [show running-config](#)

Command changes Version 5.4.8-2.1: command added

reload

Overview This command performs the same function as the [reboot](#) command.

show banner external-manager

Overview Use this command to show the current external-manager banner. The external-manager banner warns you that certain features are being managed by an external management system. For example, if you are using Vista Manager EX to manage your network, you will see a notification banner telling you which features are being managed after you enter Global Configuration Mode.

Syntax `show banner external-manager`

Mode User Exec

Example To show the external-manager banner, use the command:

```
awplus# show banner external-manager
```

Output Figure 7-1: Example output from **show banner external-manager**

```
awplus#show banner external-manager
The following features are being managed by external systems.
Configuring these features may have unintended consequences.
Manager: Network Manager
  Feature: ACLs
  Filters

Manager: Vista Manager
  Feature: Traffic control
  Application Priority
  Dynamic Traffic Management
Feature: Web control
  all features
```

Related commands [banner display external-manager](#)
[banner external-manager](#)

Command changes Version 5.5.1-1.1: command added

show clock

Overview This command displays the system's current configured local time and date. It also displays other clock related information such as timezone and summertime configuration.

Syntax show clock

Mode User Exec and Privileged Exec

Example To display the system's current local time, use the command:

```
awplus# show clock
```

Output Figure 7-2: Example output from the **show clock** command for a device using New Zealand time

```
Local Time: Mon, 17 Oct 2016 13:56:06 +1200
UTC Time: Mon, 17 Oct 2016 01:56:06 +0000
Timezone: NZST
Timezone Offset: +12:00
Summer time zone: NZDT
Summer time starts: Last Sunday in September at 02:00:00
Summer time ends: First Sunday in April at 02:00:00
Summer time offset: 60 mins
Summer time recurring: Yes
```

Table 1: Parameters in the output of the **show clock** command

Parameter	Description
Local Time	Current local time.
UTC Time	Current UTC time.
Timezone	The current configured timezone name.
Timezone Offset	Number of hours offset to UTC.
Summer time zone	The current configured summertime zone name.
Summer time starts	Date and time set as the start of summer time.
Summer time ends	Date and time set as the end of summer time.
Summer time offset	Number of minutes that summer time is offset from the system's timezone.
Summer time recurring	Whether the device will apply the summer time settings every year or only once.

**Related
commands** [clock set](#)
[clock summer-time date](#)
[clock summer-time recurring](#)
[clock timezone](#)

show cpu

Overview This command displays a list of running processes with their CPU utilization.

For information on filtering and saving command output, see the [“Getting Started with AlliedWare Plus” Feature Overview and Configuration Guide](#).

Syntax `show cpu [sort {thrds|pri|sleep|runtime}]`

Parameter	Description
sort	Changes the sorting order using the following fields. If you do not specify a field, then the list is sorted by percentage CPU utilization.
thrds	Sort by the number of threads.
pri	Sort by the process priority.
sleep	Sort by the average time sleeping.
runtime	Sort by the runtime of the process.

Mode User Exec and Privileged Exec

Examples To show the CPU utilization of current processes, sorting them by the number of threads the processes are using, use the command:

```
awplus# show cpu sort thrds
```

Output Figure 7-3: Example output from **show cpu**

```
awplus#show cpu
CPU averages:
 1 second: 0%, 20 seconds: 0%, 60 seconds: 0%
System load averages:
 1 minute: 0.16, 5 minutes: 0.13, 15 minutes: 0.13
Current CPU load:
 userspace: 2%, kernel: 6%, interrupts: 0% iowaits: 0%

user processes
=====
 pid name           thrds  cpu%   pri state sleep% runtime
763 hostd           1    2.9   20  run   0    128
803 diag_monitor    1    0.4   20  sleep 0   3292
768 hsl             14    0.4   20  sleep 0   3912
 1 init             1    0.0   20  sleep 0    686
478 rtccludge       1    0.0   20  sleep 0     9
504 portmap         1    0.0   20  sleep 0     2
17555 sh            1    0.0   20  sleep 0     1
17556 console_log_ale 1    0.0   20  sleep 0     1
 515 syslog-ng       1    0.0   20  sleep 0    153
 521 dbus-daemon     1    0.0   20  sleep 0     2
 532 automount       1    0.0   20  sleep 0    453
 571 appmond         1    0.0   20  sleep 0     41
 587 crond           1    0.0   20  sleep 0     17
 589 openhpid        9    0.0   20  sleep 0    284
 609 inetd           1    0.0   20  sleep 0     2
 761 nsm             1    0.0   20  sleep 0    260
 765 imi             1    0.0   20  sleep 0    616
 799 almond          1    0.0   20  sleep 0     52
 805 cntrd           1    0.0   20  sleep 0     45
 807 poehw           3    0.0   20  sleep 0    207
 820 authd           1    0.0   20  sleep 0     76
...

kernel threads
=====
 pid name           cpu%   pri state sleep% runtime
144 aio             0.0    0  sleep 0     0
 95 bdi-default     0.0   20  sleep 0     0
149 crypto          0.0    0  sleep 0     0
474 flush-31:4     0.0   20  sleep 0     1
143 fsnotify_mark  0.0   20  sleep 0     0
426 jffs2_gcd_mtd0 0.0   30  sleep 0   353
 96 kblockd        0.0    0  sleep 0     0
 12 khelper        0.0    0  sleep 0     0
105 khubd          0.0   20  sleep 0     0
 3 ksoftirqd/0     0.0   20  sleep 0     0
142 kswapd0        0.0   20  sleep 0     0
 2 kthreadd        0.0   20  sleep 0     0
 4 kworker/0:0     0.0   20  sleep 0    29
 6 linkwatch       0.0    0  sleep 0     0
466 loop0          0.0    0  sleep 0   801
 7 migration/0    0.0  -100  sleep 0     0
244 mtddblock0     0.0   20  sleep 0     5
 93 sync_supers    0.0   20  sleep 0     1
```

Table 2: Parameters in the output of the **show cpu** command

Parameter	Description
CPU averages	Average CPU utilization for the periods stated.
System load averages	The average number of processes waiting for CPU time for the periods stated.
Current CPU load	Current CPU utilization specified by load types.
pid	Identifier number of the process.
name	A shortened name for the process
thrds	Number of threads in the process.
cpu%	Percentage of CPU utilization that this process is consuming.
pri	Process priority state.
state	Process state; one of "run", "sleep", "zombie", and "dead".
sleep%	Percentage of time that the process is in the sleep state.
runtime	The time that the process has been running for, measured in jiffies. A jiffy is the duration of one tick of the system timer interrupt.

- Related commands**
- [show memory](#)
 - [show memory allocations](#)
 - [show memory history](#)
 - [show memory pools](#)
 - [show process](#)

show cpu history

Overview This command prints a graph showing the historical CPU utilization. For information on filtering and saving command output, see the [“Getting Started with AlliedWare Plus” Feature Overview and Configuration Guide](#).

Syntax `show cpu history`

Mode User Exec and Privileged Exec

Usage notes This command’s output displays three graphs of the percentage CPU utilization:

- per second for the last minute, then
- per minute for the last hour, then
- per 30 minutes for the last 30 hours.

Examples To display a graph showing the historical CPU utilization of the device, use the command:

```
awplus# show cpu history
```

Output Figure 7-4: Example output from the **show cpu history** command

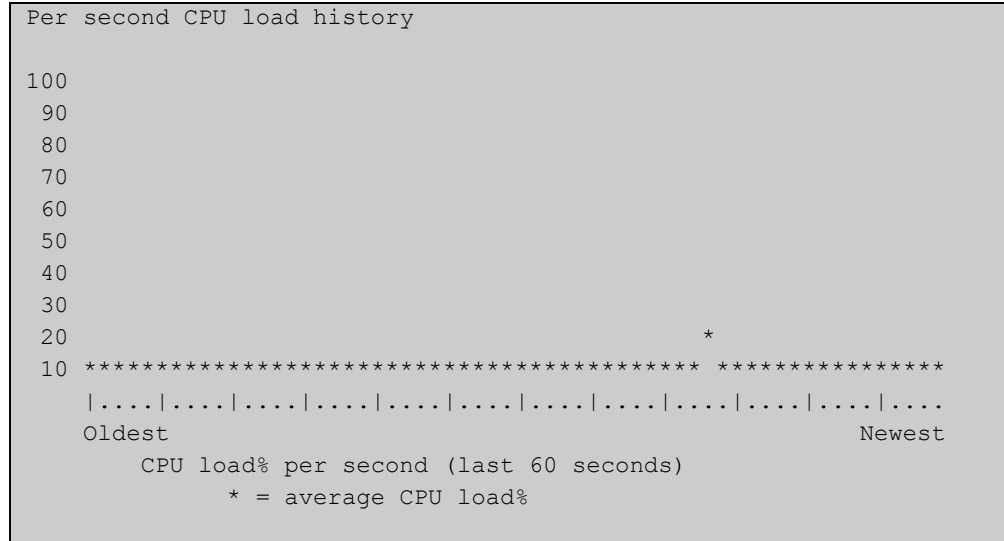

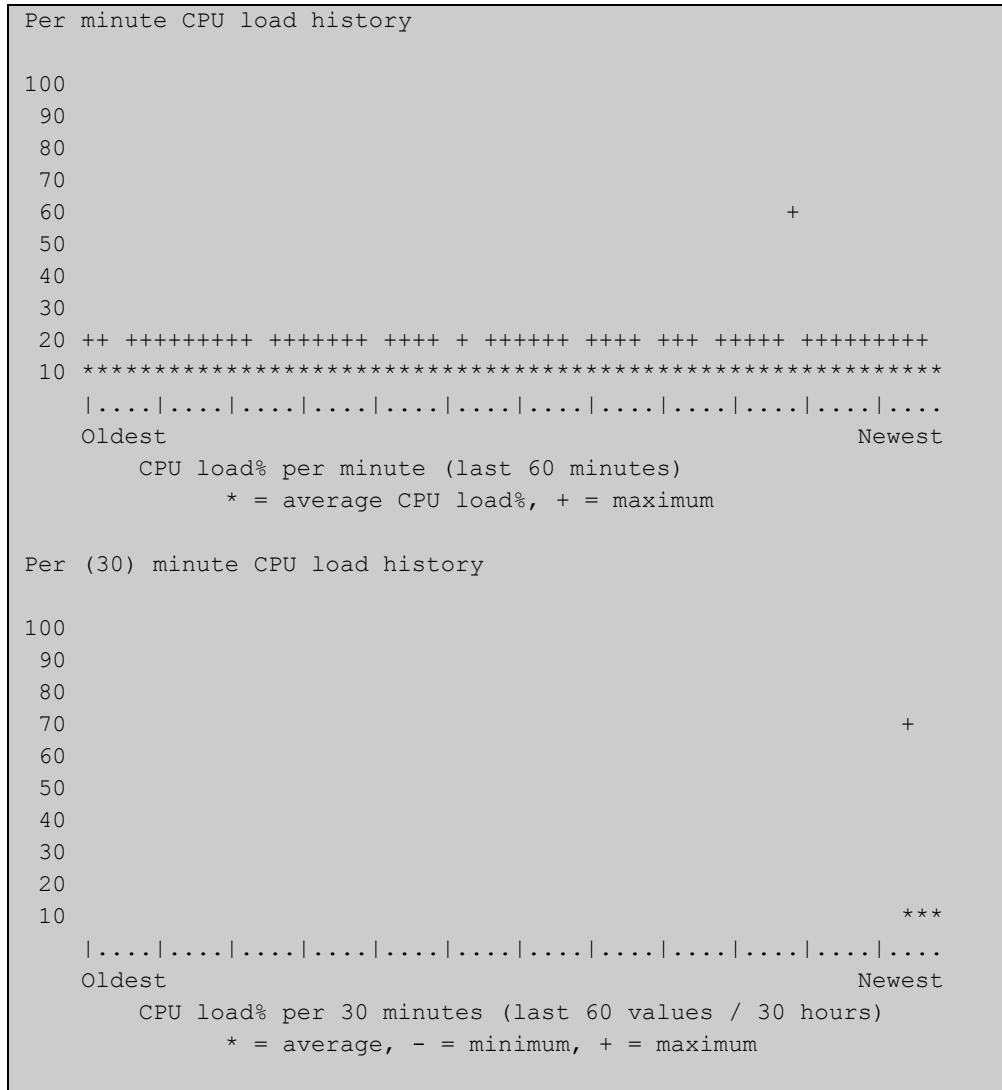

- Related commands**
- [show memory](#)
 - [show memory allocations](#)
 - [show memory pools](#)
 - [show process](#)

show debugging

Overview This command displays all debugging options in alphabetical order, indicating whether debugging is enabled or disabled for each feature.

For information on filtering and saving command output, see the [“Getting Started with AlliedWare Plus” Feature Overview and Configuration Guide](#).

Syntax show debugging

Mode User Exec and Privileged Exec

Example To find out what debugging is enabled, use the command:

```
awplus# show debugging
```

Output Figure 7-5: Example output from the **show debugging** command

```
awplus#show debugging
AAA debugging status:
  Authentication debugging is off
  Authorization debugging is off
  Accounting debugging is off
Antivirus Debugging Status: off
% Error: ATMF is not configured.
BGP debugging status:
  BGP debugging is off
  BGP nht debugging is off
  BGP nsm debugging is off
  BGP events debugging is off
  BGP keepalives debugging is off
  BGP updates debugging is off
  BGP fsm debugging is off
  BGP filter debugging is off
  BGP Route Flap Dampening debugging is off

Firewall Debugging Status: off
Traffic shaping debugging status: off
IGMP Debugging status:
  IGMP Decoder debugging is off
  IGMP Encoder debugging is off
  IGMP Events debugging is off
  IGMP FSM debugging is off
  IGMP Tree-Info-Base (TIB) debugging is off
DNS Relay debugging status:
  debugging is off
IP packet debugging status:
OSPFv3 debugging status:
...
```

show interface memory

Overview This command displays the shared memory used by either all interfaces, or the specified interface or interfaces. The output is useful for diagnostic purposes by Allied Telesis authorized service personnel.

For information on filtering and saving command output, see the [“Getting Started with AlliedWare Plus” Feature Overview and Configuration Guide](#).

Syntax `show interface memory`
`show interface <port-list> memory`

Parameter	Description
<port-list>	Display information about only the specified port or ports. The port list can be: <ul style="list-style-type: none">• an Eth port (e.g. eth1)• an 802.1Q Ethernet sub-interface (e.g. eth1.10, where ‘10’ is the VLAN ID specified by the encapsulation dot1q command)• a switchport (e.g. port1.0.4)• a static channel group (e.g. sa2)• a dynamic (LACP) channel group (e.g. po2)• a continuous range of ports separated by a hyphen (e.g. port1.0.1-1.0.4)• a comma-separated list (e.g. port1.0.1,port1.0.3-1.0.4). Do not mix port types in the same list.

Mode User Exec and Privileged Exec

Example To display the shared memory used by all interfaces, use the command:

```
awplus# show interface memory
```

To display the shared memory used by port1.0.1 and port1.0.3 to port1.0.4, use the command:

```
awplus# show interface port1.0.1,port1.0.3-port1.0.4 memory
```

Output Figure 7-6: Example output from the **show interface memory** command

```
awplus#show interface memory
Vlan blocking state shared memory usage
-----
Interface  shmid      Bytes Used  natch  Status
port1.0.1  294921     512        1      1
port1.0.2  491535     512        1      1
port1.0.3  458766     512        1      1
...
eth1       393228     512        1      1
lo         360459     512        1      1
```

Figure 7-7: Example output from **show interface <port-list> memory** for a list of interfaces

```
awplus#show interface port1.0.1,port1.0.3-port1.0.4 memory
Vlan blocking state shared memory usage
-----
Interface      shmid      Bytes Used      natch      Status
port1.0.1      589842     512              1
port1.0.3      688149     512              1
port1.0.4      327690     512              1
```

**Related
commands**

- [show interface brief](#)
- [show interface status](#)
- [show interface switchport](#)

show memory

Overview This command displays the memory used by each process that is currently running.

For information on filtering and saving command output, see the [“Getting Started with AlliedWare Plus” Feature Overview and Configuration Guide](#).

Syntax `show memory [sort {size|peak|stk}]`

Parameter	Description
sort	Changes the sorting order for the list of processes. If you do not specify this, then the list is sorted by percentage memory utilization.
size	Sort by the amount of memory the process is currently using.
peak	Sort by the amount of memory the process is currently using.
stk	Sort by the stack size of the process.

Mode User Exec and Privileged Exec

Example To display the memory used by the current running processes, use the command:

```
awplus# show memory
```

Output Figure 7-8: Example output from **show memory**

```
awplus#show memory

RAM total: 824680 kB; free: 635032 kB; buffers: 20272 kB

user processes
=====
 pid name          mem%  size (kB)  peak (kB)  data (kB)  stk (kB)  virt (kB)
1443 squid          1.9    16408    299768    23568      264    299768
1441 squid          1.9    16416    299776    23568      272    299776
1440 squid          1.9    16416    299776    23568      272    299776
1439 squid          1.9    16416    299776    23568      272    299776
1438 squid          1.9    16152    298928    23568      264    298864
1226 imi            1.3    10968     23104     2760       160     22912
1228 hsl            1.2    10512    692944    608160     144    631856
2156 imish          1.0     8856    158456    75904      160     94696
1221 nsm            1.0     9008     21696     1968       152    21632
1296 ospfd          0.8     6936     19144     1016       144    19080
1293 bgpd           0.8     7264     19184     1168       152    19120
1291 pimd           0.8     6600     20992     2944       144    20928
1283 ripd           0.8     6640     18328     944        152    18256
...
```

Table 3: Parameters in the output of the **show memory** command

Parameter	Description
RAM total	Total amount of RAM memory free.
free	Available memory size.
buffers	Memory allocated kernel buffers.
pid	Identifier number for the process.
name	Short name used to describe the process.
mem%	Percentage of memory utilization the process is currently using.
size	Amount of memory currently used by the process.
peak	Greatest amount of memory ever used by the process.
data	Amount of memory used for data.
stk	The stack size.

Related commands

- [show memory allocations](#)
- [show memory history](#)
- [show memory pools](#)
- [show memory shared](#)

show memory allocations

Overview This command displays the memory allocations used by processes. For information on filtering and saving command output, see the [“Getting Started with AlliedWare Plus” Feature Overview and Configuration Guide](#).

Syntax show memory allocations [*<process>*]

Parameter	Description
<i><process></i>	Displays the memory allocation used by the specified process.

Mode User Exec and Privileged Exec

Example To display the memory allocations used by all processes on your device, use the command:

```
awplus# show memory allocations
```

Output Figure 7-9: Example output from the **show memory allocations** command

```
awplus#show memory allocations
Memory allocations for imi
-----

Current 15093760 (peak 15093760)

Statically allocated memory:
- binary/exe           :    1675264
- libraries            :    8916992
- bss/global data     :    2985984
- stack                :    139264

Dynamically allocated memory (heap):
- total allocated      :    1351680
- in use               :    1282440
- non-mmapped         :    1351680
- maximum total allocated :    1351680
- total free space    :     69240
- releasable          :     68968
- space in freed fastbins :      16

Context
      filename:line   allocated   freed
+          lib.c:749     484
.
.
.
```

Related commands

- show memory
- show memory history
- show memory pools
- show memory shared
- show tech-support

show memory history

Overview This command prints a graph showing the historical memory usage.
For information on filtering and saving command output, see the [“Getting Started with AlliedWare Plus” Feature Overview and Configuration Guide](#).

Syntax `show memory history`

Mode User Exec and Privileged Exec

Usage notes This command’s output displays three graphs of the percentage memory utilization:

- per second for the last minute, then
- per minute for the last hour, then
- per 30 minutes for the last 30 hours.

Examples To show a graph displaying the historical memory usage, use the command:

```
awplus# show memory history
```

Output Figure 7-10: Example output from the **show memory history** command

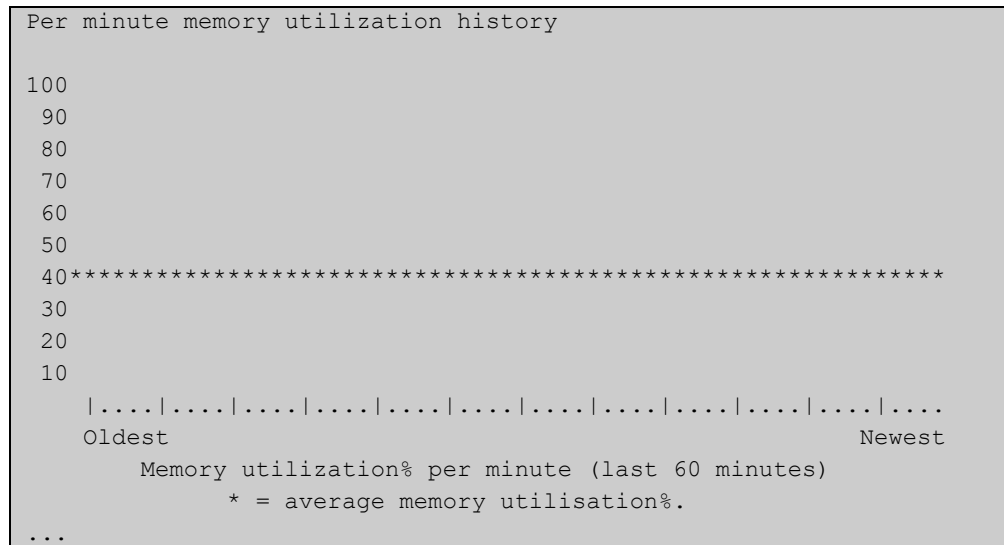

- Related commands**
- [show memory allocations](#)
 - [show memory pools](#)
 - [show memory shared](#)
 - [show tech-support](#)

show memory pools

Overview This command shows the memory pools used by processes.

For information on filtering and saving command output, see the [“Getting Started with AlliedWare Plus” Feature Overview and Configuration Guide](#).

Syntax `show memory pools [<process>]`

Parameter	Description
<process>	Displays the memory pools used by the specified process.

Mode User Exec and Privileged Exec

Example To show the memory pools used by processes, use the command:

```
awplus# show memory pools
```

Output Figure 7-11: Example output from the **show memory pools** command

```
awplus#show memory pools
Memory pools for imi
-----

Current 15290368 (peak 15290368)

Statically allocated memory:
- binary/exe           : 1675264
- libraries            : 8916992
- bss/global data     : 2985984
- stack                : 139264

Dynamically allocated memory (heap):
- total allocated      : 1548288
- in use               : 1479816
- non-mmapped         : 1548288
- maximum total allocated : 1548288
- total free space     : 68472
- releasable          : 68200
- space in freed fastbins : 16
.
.
.
```

Related commands

- [show memory allocations](#)
- [show memory history](#)
- [show tech-support](#)

show memory shared

Overview This command displays shared memory allocation information. The output is useful for diagnostic purposes by Allied Telesis authorized service personnel.

For information on filtering and saving command output, see the [“Getting Started with AlliedWare Plus” Feature Overview and Configuration Guide](#).

Syntax `show memory shared`

Mode User Exec and Privileged Exec

Example To display information about the shared memory allocation used on the device, use the command:

```
awplus# show memory shared
```

Output Figure 7-12: Example output from the **show memory shared** command

```
awplus#show memory shared
Shared Memory Status
-----
Segment allocated   = 39
Pages allocated     = 39
Pages resident      = 11

Shared Memory Limits
-----
Maximum number of segments           = 4096
Maximum segment size (kbytes)        = 32768
Maximum total shared memory (pages) = 2097152
Minimum segment size (bytes)         = 1
```

Related commands

- [show memory allocations](#)
- [show memory history](#)
- [show memory](#)

show process

Overview This command lists a summary of the current running processes.

For information on filtering and saving command output, see the [“Getting Started with AlliedWare Plus” Feature Overview and Configuration Guide](#).

Syntax `show process [sort {cpu|mem}]`

Parameter	Description
sort	Changes the sorting order for the list of processes.
cpu	Sorts the list by the percentage of CPU utilization.
mem	Sorts the list by the percentage of memory utilization.

Mode User Exec and Privileged Exec

Usage notes This command displays a snapshot of currently-running processes. If you want to see CPU or memory utilization history instead, use the commands [show cpu history](#) or [show memory history](#).

Example To display a summary of the current running processes, use the command:

```
awplus# show process
```

Output Figure 7-13: Example output from the **show process** command

```
CPU averages:
 1 second: 8%, 20 seconds: 5%, 60 seconds: 5%
System load averages:
 1 minute: 0.04, 5 minutes: 0.08, 15 minutes: 0.12
Current CPU load:
 userspace: 9%, kernel: 9%, interrupts: 0% iowaits: 0%
RAM total: 514920 kB; free: 382600 kB; buffers: 16368 kB

user processes
=====
pid name      thrds  cpu%  mem%  pri  state  sleep%
962 pss        12    0     6    25  sleep    5
1  init         1     0     0    25  sleep    0
797 syslog-ng   1     0     0    16  sleep   88
...
kernel threads
=====
pid name      cpu%  pri  state  sleep%
71  aio/0      0    20  sleep  0
3   events/0  0    10  sleep  98
...
```

Table 4: Parameters in the output from the **show process** command

Parameter	Description
CPU averages	Average CPU utilization for the periods stated.
System load averages	The average number of processes waiting for CPU time for the periods stated.
Current CPU load	Current CPU utilization specified by load types
RAM total	Total memory size.
free	Available memory.
buffers	Memory allocated to kernel buffers.
pid	Identifier for the process.
name	Short name to describe the process.
thrds	Number of threads in the process.
cpu%	Percentage of CPU utilization that this process is consuming.
mem%	Percentage of memory utilization that this process is consuming.
pri	Process priority.
state	Process state; one of "run", "sleep", "stop", "zombie", or "dead".
sleep%	Percentage of time the process is in the sleep state.

Related commands [show cpu](#)
[show cpu history](#)

show reboot history

Overview Use this command to display the device's reboot history.

Syntax `show reboot history`

Mode User Exec and Privileged Exec

Example To show the reboot history, use the command:

```
awplus# show reboot history
```

Output Figure 7-14: Example output from the **show reboot history** command

```
awplus#show reboot history

<date>      <time>      <type>      <description>
-----
2016-10-10  01:42:04  Expected    User Request
2016-10-10  01:35:31  Expected    User Request
2016-10-10  01:16:25  Unexpected  Rebooting due to critical process (network/nsm)
failure!
2016-10-10  01:11:04  Unexpected  Rebooting due to critical process (network/nsm)
failure!
2016-10-09  19:56:16  Expected    User Request
2016-10-09  19:51:20  Expected    User Request
```

Table 5: Parameters in the output from the **show reboot history** command

Parameter	Description
Unexpected	A non-intended reboot.
Expected	A planned or user-triggered reboot.
User request	User initiated reboot via the CLI.

Related commands [show tech-support](#)

show router-id

Overview Use this command to show the Router ID of the current system.

Syntax `show router-id`

Mode User Exec and Privileged Exec

Example To display the Router ID of the current system, use the command:

```
awplus# show router-id
```

Output Figure 7-15: Example output from the **show router-id** command

```
awplus>show router-id  
Router ID: 10.55.0.2 (automatic)
```

show system

Overview This command displays general system information about the device, including the hardware, memory usage, and software version. It also displays location and contact details when these have been set.

For information on filtering and saving command output, see the [“Getting Started with AlliedWare Plus” Feature Overview and Configuration Guide](#).

Syntax `show system`

Mode User Exec and Privileged Exec

Example To display configuration information, use the command:

```
awplus# show system
```

Output Figure 7-16: Example output from **show system**

```
System Status                               Mon Sep 28 08:42:16 2020
-----
Board      ID  Bay      Board Name          Rev  Serial number
-----
Base      425          AR2050V            X1-0  A05049G27NE2004
-----
RAM:  Total: 824680 kB Free: 634632 kB
Flash: 3.6GB Used: 109.1MB Available: 3.3GB
-----
Environment Status : Normal
Uptime              : 0 days 23:11:05
Bootloader version  : 5.0.6

Current software   : AR2050V-5.5.0-1.3.rel
Software version   : 5.5.0-1.3
Build date         : Wed Sep 9 21:10 UTC 2020

Current boot config: flash:/default.cfg (file exists)

System Name
awplus
System Contact
System Location
```

Related commands [show system environment](#)

show system environment

Overview This command displays the current environmental status of your device and its power supplies and any other expansion options. The environmental status covers information about temperatures, fans, and voltage.

For information on filtering and saving command output, see the [“Getting Started with AlliedWare Plus” Feature Overview and Configuration Guide](#).

Syntax `show system environment`

Mode User Exec and Privileged Exec

Example To display the system’s environmental status, use the command:

```
awplus# show system environment
```

Output Figure 7-17: Example output from **show system environment**

```
awplus#show system environment
Environment Monitoring Status

Overall Status: Normal

Resource ID: 1 Name: AR2050V
ID Sensor (Units) Reading Low Limit High Limit Status
1 Fan: Fan (Rpm) 3516 2411 - Ok
2 Voltage: 2.5V (Volts) 2.461 2.344 2.865 Ok
3 Voltage: Battery (Volts) 3.181 2.700 3.586 Ok
4 Voltage: 3.3V (Volts) 3.266 2.973 3.627 Ok
5 Voltage: 5.0V (Volts) 4.974 4.505 5.495 Ok
6 Voltage: 12V (Volts) 11.563 10.813 13.188 Ok
7 Voltage: 0.92V (Volts) 0.944 0.872 0.970 Ok
8 Temp: Internal (Degrees C) 32 58 (Hyst) 65 Ok
```

Related commands

- [show system](#)
- [show system environment counters](#)
- [trigger](#)
- [type env-sensor](#)

show system environment counters

Overview Use this command to see the environmental sensor counters.

Syntax `show system environment counters`

Mode User Exec and Privileged Exec

Example To show the environment sensor counters, use the following command:

```
awplus# show system environment counters
```

Output Figure 7-18: Example output from **show system environment counters**

```
awplus#show system environment counters
Environment Monitoring Counters

Resource ID: 1 Name: AR2050V
ID Sensor Value Threshold Checked Read Alarm Alarm
readings readings readings errors asserted cleared
1 Voltage: 2.5V 698 1394 0 0 0 0
2 Voltage: Battery 698 1394 0 0 0 0
3 Voltage: 3.3V 698 1394 0 0 0 0
4 Voltage: 5.0V 698 1394 0 0 0 0
5 Voltage: 12.0V 698 1394 0 0 0 0
6 Voltage: 0.85V 698 1394 0 0 0 0
7 Temp: Internal 698 700 0 0 0 0
```

Table 7-1: Parameters in the output from **show system environment counters**

Parameter	Description
Value readings	Number of times that the value of this sensor has been read.
Threshold readings	Number of times that a threshold value related to this sensor has been read.
Checked readings	Number of times that this sensor has gone outside a threshold and has been re-read to confirm this is a genuine error.
Read errors	Number of times that there was an error returned when reading this sensor or one of its threshold values.
Alarm asserted	Number of times that this sensor has entered the fault state.
Alarm cleared	Number of times that this sensor has left the fault state.

Related commands [show system](#)

show system environment

Command changes Version 5.5.0-0.1: command added

show system interrupts

Overview Use this command to display the number of interrupts for each IRQ (Interrupt Request) used to interrupt input lines on a PIC (Programmable Interrupt Controller) on your device.

For information on filtering and saving command output, see the [“Getting Started with AlliedWare Plus” Feature Overview and Configuration Guide](#).

Syntax `show system interrupts`

Mode User Exec and Privileged Exec

Example To display information about the number of interrupts for each IRQ in your device, use the command:

```
awplus# show system interrupts
```

Output Figure 7-19: Example output from the **show system interrupts** command

```
awplus#show system interrupts
      CPU0      CPU1
8:    151378    152020    Core Enabled  0  timer
16:      0      0      CIU Enabled  0  Ethernet
25:     256      0      CIU-W Enabled  0  octeon_wdt
26:      0     256      CIU-W Enabled  0  octeon_wdt
41:   946096   947120      CIU-M Enabled  0  SMP-IPI
51:      0      0      CIU Enabled  0  RGMII
53:      0      0      CIU Enabled  0  Ethernet
59:    1025      0      CIU Enabled  0  serial
60:    5825      0      CIU Enabled  0  i2c-octeon
61:      3      0      CIU Enabled  0  i2c-octeon
63:      0      0      CIB Enabled  0  xhci-hcd:usb1
65:      0      0  CIU-GPIO Enabled  0  0-0021
...

```

Related commands [show system environment](#)

show system mac

Overview This command displays the physical MAC address of the device.

Syntax `show system mac`

Mode User Exec and Privileged Exec

Example To display the physical MAC address enter the following command:

```
awplus# show system mac
```

Output Figure 7-20: Example output from the **show system mac** command

```
awplus#show system mac
0200.0034.5682 (eth1)
0200.0034.5683 (eth2)
0200.0034.5684 (system)
```

show system pci device

Overview Use this command to display the PCI devices on your device.

Syntax `show system pci device`

Mode User Exec and Privileged Exec

Example To display information about the PCI devices on your device, use the command:

```
awplus# show system pci device
```

Output

```
awplus#show system pci device
00:0c.0 Class 0200: 11ab:00d1 (rev 01)
  Flags: bus master, 66Mhz, medium devsel, latency 128, IRQ 113
  Memory at 5ffff000 (32-bit, non-prefetchable) [size=4K]
  Memory at 58000000 (32-bit, non-prefetchable) [size=64M]

00:0d.0 Class 0200: 11ab:00d1 (rev 01)
  Flags: bus master, 66Mhz, medium devsel, latency 128, IRQ 116
  Memory at 57fff000 (32-bit, non-prefetchable) [size=4K]
  Memory at 50000000 (32-bit, non-prefetchable) [size=64M]
```

Related commands [show system environment](#)
[show system pci tree](#)

show system pci tree

Overview Use this command to display the PCI tree on your device.

Syntax `show system pci tree`

Mode User Exec and Privileged Exec

Example To display information about the PCI tree on your device, use the command:

```
awplus# show system pci tree
```

Related commands [show system environment](#)
[show system pci device](#)

show system serialnumber

Overview This command shows the serial number information for the device.
For information on filtering and saving command output, see the [“Getting Started with AlliedWare Plus” Feature Overview and Configuration Guide](#).

Syntax `show system serialnumber`

Mode User Exec and Privileged Exec

Example To display the serial number information for the device, use the command:

```
awplus# show system serialnumber
```

Output Figure 7-21: Example output from the **show system serialnumber** command

```
awplus#show system serialnumber  
45AX5300X
```

show tech-support

Overview This command generates system and debugging information for the device and saves it to a file.

This command is useful for collecting a large amount of information so that it can then be analyzed for troubleshooting purposes. The output of this command can be provided to technical support staff when reporting a problem.

You can optionally limit the command output to display only information for a given protocol or feature. The features available depend on your device and will be a subset of the features listed in the table below.

Syntax `show tech-support`
{ [all|atmf|auth|bgp|card|dhcpsn|epsr|firewall|igmp|ip|ipv6|mld|openflow|ospf|ospf6|pim|rip|ripng|stack|stp|system|tacacs+|update]} [outfile <filename>]

Parameter	Description
all	Display full information
atmf	Display ATMF-specific information
auth	Display authentication-related information
bgp	Display BGP-related information
card	Display Chassis Card specific information
dhcpsn	Display DHCP Snooping specific information
epsr	Display EPSR specific information
firewall	Display firewall specific information
igmp	Display IGMP specific information
ip	Display IP specific information
ipv6	Display IPv6 specific information
mld	Display MLD specific information
openflow	Display information related to OpenFlow
ospf	Display OSPF related information
ospf6	Display OSPF6 specific information
pim	Display PIM related information
rip	RIP related information
ripng	Display RIPNG specific information
stack	Display stacking device information
stp	Display STP specific information
system	Display general system information

Parameter	Description
tacacs+	Display TACACS+ information
update	Display resource update specific information
	Output modifier
>	Output redirection
>>	Output redirection (append)
outfile	Output file name
<filename>	Specifies a name for the output file. If no name is specified, this file will be saved as: tech-support.txt.gz.

Default Captures **all** information for the device.

By default the output is saved to the file 'tech-support.txt.gz' in the current directory. If this file already exists in the current directory then a new file is generated with the time stamp appended to the file name, for example 'tech-support20161009.txt.gz', so the previous file is retained.

Usage notes The command generates a large amount of output, which is saved to a file in compressed format. The output file name can be specified by outfile option. If the output file already exists, a new file name is generated with the current time stamp. If the output filename does not end with ".gz", then ".gz" is appended to the filename. Since output files may be too large for Flash on the device we recommend saving files to external memory or a TFTP server whenever possible to avoid device lockup. This method is not likely to be appropriate when running the working set option of AMF across a range of physically separated devices.

Mode Privileged Exec

Examples To produce the output needed by technical support staff, use the command:

```
awplus# show tech-support
```

speed (asyn)

Overview This command changes the console speed from the device. Note that a change in console speed is applied for subsequent console sessions. Exit the current session to enable the console speed change using the [clear line console](#) command.

Syntax `speed <console-speed-in-bps>`

Parameter	Description
<code><console-speed-in-bps></code>	Console speed Baud rate in bps (bits per second).
	1200 1200 Baud
	2400 2400 Baud
	9600 9600 Baud
	19200 19200 Baud
	38400 38400 Baud
	57600 57600 Baud
	115200 115200 Baud

Default The default console speed baud rate is 9600 bps.

Mode Line Configuration

Usage notes This command is used to change the console (asyn) port speed. Set the console speed to match the transmission rate of the device connected to the console (asyn) port on your device.

Example To set the terminal console (asyn0) port speed from the device to 57600 bps, then exit the session, use the commands:

```
awplus# configure terminal
awplus(config)# line console 0
awplus(config-line)# speed 57600
awplus(config-line)# exit
awplus(config)# exit
awplus# exit
```

Then log in again to enable the change:

```
awplus login:
Password:
awplus>
```

Related commands

- clear line console
- line
- show running-config
- show startup-config
- speed

terminal monitor

Overview Use this command to display debugging output on a terminal.
To display the cursor after a line of debugging output, press the Enter key.
Use the command **terminal no monitor** or **no terminal monitor** to stop displaying debugging output on the terminal. Alternatively, you can use the timeout option to stop displaying debugging output on the terminal after a set time.

Syntax terminal monitor [*<1-60>*]
terminal no monitor
no terminal monitor

Parameter	Description
<i><1-60></i>	Set a timeout between 1 and 60 seconds for terminal output.

Default Disabled

Mode User Exec and Privileged Exec

Examples To display debugging output on a terminal, enter the command:

```
awplus# terminal monitor
```

To display debugging on the terminal for 60 seconds, enter the command:

```
awplus# terminal monitor 60
```

To stop displaying debugging output on the terminal, use the command:

```
awplus# no terminal monitor
```

Related commands All debug commands

Command changes Version 5.4.8-0.2: **no terminal monitor** added as an alias for **terminal no monitor**

undebug all

Overview This command applies the functionality of the [no debug all](#) command.

8

Logging Commands

Introduction

Overview This chapter provides an alphabetical reference of commands used to configure logging. See the [Logging Feature Overview and Configuration Guide](#) for more information about the different types of log and how to filter log messages.

- Command List**
- [“clear exception log”](#) on page 342
 - [“clear log”](#) on page 343
 - [“clear log buffered”](#) on page 344
 - [“clear log external”](#) on page 345
 - [“clear log permanent”](#) on page 346
 - [“connection-log events”](#) on page 347
 - [“copy buffered-log”](#) on page 348
 - [“copy permanent-log”](#) on page 349
 - [“default log buffered”](#) on page 350
 - [“default log console”](#) on page 351
 - [“default log email”](#) on page 352
 - [“default log external”](#) on page 353
 - [“default log host”](#) on page 354
 - [“default log monitor”](#) on page 355
 - [“default log permanent”](#) on page 356
 - [“log buffered”](#) on page 357
 - [“log buffered \(filter\)”](#) on page 358
 - [“log buffered exclude”](#) on page 361
 - [“log buffered size”](#) on page 364

- [“log console”](#) on page 365
- [“log console \(filter\)”](#) on page 366
- [“log console exclude”](#) on page 369
- [“log date-format”](#) on page 372
- [“log email”](#) on page 373
- [“log email \(filter\)”](#) on page 374
- [“log email exclude”](#) on page 377
- [“log email time”](#) on page 380
- [“log external”](#) on page 382
- [“log external \(filter\)”](#) on page 384
- [“log external exclude”](#) on page 387
- [“log external rotate”](#) on page 390
- [“log external size”](#) on page 392
- [“log facility”](#) on page 393
- [“log host”](#) on page 395
- [“log host \(filter\)”](#) on page 397
- [“log host exclude”](#) on page 401
- [“log host source”](#) on page 404
- [“log host startup-delay”](#) on page 405
- [“log host time”](#) on page 407
- [“log monitor \(filter\)”](#) on page 409
- [“log monitor exclude”](#) on page 412
- [“log permanent”](#) on page 415
- [“log permanent \(filter\)”](#) on page 416
- [“log permanent exclude”](#) on page 419
- [“log permanent size”](#) on page 422
- [“log-rate-limit nsm”](#) on page 423
- [“log trustpoint”](#) on page 424
- [“log url-requests”](#) on page 425
- [“show connection-log events”](#) on page 426
- [“show counter log”](#) on page 427
- [“show exception log”](#) on page 428
- [“show log”](#) on page 429
- [“show log config”](#) on page 431
- [“show log external”](#) on page 433

- [“show log permanent”](#) on page 434
- [“show running-config log”](#) on page 435
- [“unmount”](#) on page 436

clear exception log

Overview This command resets the contents of the exception log, but does not remove the associated core files.

Syntax `clear exception log`

Mode Privileged Exec

Example `awplus# clear exception log`

clear log

Overview This command removes the contents of the buffered and permanent logs.

Syntax `clear log`

Mode Privileged Exec

Example To delete the contents of the buffered and permanent log use the command:

```
awplus# clear log
```

Related commands

- [clear log buffered](#)
- [clear log permanent](#)
- [show log](#)

clear log buffered

Overview This command removes the contents of the buffered log.

Syntax `clear log buffered`

Mode Privileged Exec

Example To delete the contents of the buffered log use the following commands:

```
awplus# clear log buffered
```

Related commands

- [default log buffered](#)
- [log buffered](#)
- [log buffered \(filter\)](#)
- [log buffered size](#)
- [log buffered exclude](#)
- [show log](#)
- [show log config](#)

clear log external

Overview Use this command to delete the external log file from the USB storage device it is stored on.

If the external log is rotating between multiple files, this command deletes all those files, not just the most recent one.

Syntax `clear log external`

Mode Privileged Exec

Example To delete the external log file, use the command:

```
awplus# clear log external
```

Related commands

- [default log external](#)
- [log external](#)
- [log external \(filter\)](#)
- [log external exclude](#)
- [log external rotate](#)
- [log external size](#)
- [show log config](#)
- [show log external](#)
- [unmount](#)

Command changes Version 5.4.7-1.1: command added

clear log permanent

Overview This command removes the contents of the permanent log.

Syntax `clear log permanent`

Mode Privileged Exec

Example To delete the contents of the permanent log use the following commands:

```
awplus# clear log permanent
```

Related commands

- [default log permanent](#)
- [log permanent](#)
- [log permanent \(filter\)](#)
- [log permanent exclude](#)
- [log permanent size](#)
- [show log config](#)
- [show log permanent](#)

connection-log events

Overview Use this command to enable extra logging for indicating the start and the end of connections passing through the firewall.

Use the **no** variant of this command to turn off the extra logging of connections passing through the firewall.

Syntax `connection-log events [new|end|all]`
`no connection-log events [new|end|all]`

Parameter	Description
new	New connection
end	Connections closed
all	All new connections and connections closed. Default.

Default Connection logging is not enabled by default.

Mode Global Configuration.

Usage notes There are two types of messages you can log: new connections and connections that ended. You can control the amount of messages you log by choosing to log either type of message or all of the message types.

Messages contain the following information:

- time
- source and destination addresses (NATed and unNATed)
- protocol
- source and destination ports (NATed and unNATed)
- bytes and packets passed (found in the connection end message)

Example To log all of the new connections and all of the closed connections, use the commands:

```
awplus# configure terminal
awplus(config)# connection-log events all
```

Related commands [show connection-log events](#)

Command changes Version 5.4.7-1.1: command added.

copy buffered-log

Overview Use this command to copy the buffered log to an internal or external destination.

Syntax `copy buffered-log <destination-name>`

Parameter	Description
<code><destination-name></code>	The filename and path for the destination file. See Introduction on page 152 for valid syntax.

Mode Privileged Exec

Example To copy the buffered log file into a folder in Flash named "buffered-log" and name the file "buffered-log.log", use the command:

```
awplus# copy buffered-log flash:/buffered-log/buffered-log.log
```

To copy the buffered log file onto a USB storage device and name the file "buffered-log.log", use the command:

```
awplus# copy buffered-log usb:/buffered-log.log
```

Related commands

- [log buffered](#)
- [show file systems](#)
- [show log](#)

Command changes Version 5.4.7-1.1: command added

copy permanent-log

Overview Use this command to copy the permanent log to an internal or external destination.

Syntax `copy permanent-log <destination-name>`

Parameter	Description
<code><destination-name></code>	The filename and path for the destination file. See Introduction on page 152 for valid syntax.

Mode Privileged Exec

Example To copy the permanent log file into a folder in Flash named “perm-log” and name the file “permanent-log.log”, use the command:

```
awplus# copy permanent-log flash:/perm-log/permanent-log.log
```

To copy the permanent log file onto a USB storage device and name the file “permanent-log.log”, use the command:

```
awplus# copy permanent-log usb:/permanent-log.log
```

Related commands

- [log permanent](#)
- [show file systems](#)
- [show log permanent](#)

Command changes Version 5.4.7-1.1: command added

default log buffered

Overview This command restores the default settings for the buffered log stored in RAM. By default the size of the buffered log is 50 kB and it accepts messages with the severity level of “warnings” and above.

Syntax `default log buffered`

Default The buffered log is enabled by default.

Mode Global Configuration

Example To restore the buffered log to its default settings use the following commands:

```
awplus# configure terminal
awplus(config)# default log buffered
```

Related commands

- [clear log buffered](#)
- [log buffered](#)
- [log buffered \(filter\)](#)
- [log buffered size](#)
- [log buffered exclude](#)
- [show log](#)
- [show log config](#)

default log console

Overview This command restores the default settings for log messages sent to the terminal when a `log console` command is issued. By default all messages are sent to the console when a **log console** command is issued.

Syntax `default log console`

Mode Global Configuration

Example To restore the log console to its default settings use the following commands:

```
awplus# configure terminal
awplus(config)# default log console
```

Related commands

- `log console`
- `log console (filter)`
- `log console exclude`
- `show log config`

default log email

Overview This command restores the default settings for log messages sent to an email address. By default no filters are defined for email addresses. Filters must be defined before messages will be sent. This command also restores the remote syslog server time offset value to local (no offset).

Syntax `default log email <email-address>`

Parameter	Description
<code><email-address></code>	The email address to send log messages to

Mode Global Configuration

Example To restore the default settings for log messages sent to the email address `admin@alliedtelesis.com` use the following commands:

```
awplus# configure terminal
awplus(config)# default log email admin@alliedtelesis.com
```

Related commands

- [log email](#)
- [log email \(filter\)](#)
- [log email exclude](#)
- [log email time](#)
- [show log config](#)

default log external

Overview Use this command to restore the default settings for the external log. By default, the size of the external log is 50 kB, it rotates through 1 additional file, and it accepts messages with a severity level of notices and above.

Note that this command does not clear the configured filename for the external log.

Syntax `default log external`

Mode Global Configuration

Example To restore the default settings for the external log, use the commands:

```
awplus# configure terminal
awplus(config)# default log external
```

Related commands

- [clear log external](#)
- [log external](#)
- [log external \(filter\)](#)
- [log external exclude](#)
- [log external rotate](#)
- [log external size](#)
- [show log config](#)
- [show log external](#)
- [unmount](#)

Command changes Version 5.4.7-1.1: command added

default log host

Overview This command restores the default settings for log sent to a remote syslog server. By default no filters are defined for remote syslog servers. Filters must be defined before messages will be sent. This command also restores the remote syslog server time offset value to local (no offset).

Syntax `default log host <ip-addr>`

Parameter	Description
<code><ip-addr></code>	The IP address of a remote syslog server

Mode Global Configuration

Example To restore the default settings for messages sent to the remote syslog server with IP address 10.32.16.21 use the following commands:

```
awplus# configure terminal
awplus(config)# default log host 10.32.16.21
```

Related commands

- [log host](#)
- [log host \(filter\)](#)
- [log host exclude](#)
- [log host source](#)
- [log host time](#)
- [show log config](#)

default log monitor

Overview This command restores the default settings for log messages sent to the terminal when a [terminal monitor](#) command is used.

Syntax `default log monitor`

Default All messages are sent to the terminal when a [terminal monitor](#) command is used.

Mode Global Configuration

Example To restore the log monitor to its default settings use the following commands:

```
awplus# configure terminal
awplus(config)# default log monitor
```

Related commands

- [log monitor \(filter\)](#)
- [log monitor exclude](#)
- [show log config](#)
- [terminal monitor](#)

default log permanent

Overview This command restores the default settings for the permanent log stored in NVS. By default, the size of the permanent log is 50 kB and it accepts messages with the severity level of `warnings` and above.

Syntax `default log permanent`

Default The permanent log is enabled by default.

Mode Global Configuration

Example To restore the permanent log to its default settings use the following commands:

```
awplus# configure terminal
awplus(config)# default log permanent
```

Related commands

- [clear log permanent](#)
- [log permanent](#)
- [log permanent \(filter\)](#)
- [log permanent exclude](#)
- [log permanent size](#)
- [show log config](#)
- [show log permanent](#)

log buffered

Overview This command configures the device to store log messages in RAM. Messages stored in RAM are not retained on the device over a restart. Once the buffered log reaches its configured maximum allowable size old messages will be deleted to make way for new ones.

Syntax `log buffered`
`no log buffered`

Default The buffered log is configured by default.

Mode Global Configuration

Examples To configured the device to store log messages in RAM use the following commands:

```
awplus# configure terminal
awplus(config)# log buffered
```

To configure the device to not store log messages in a RAM buffer use the following commands:

```
awplus# configure terminal
awplus(config)# no log buffered
```

Related commands

- [clear log buffered](#)
- [copy buffered-log](#)
- [default log buffered](#)
- [log buffered \(filter\)](#)
- [log buffered size](#)
- [log buffered exclude](#)
- [show log](#)
- [show log config](#)

log buffered (filter)

Overview Use this command to create a filter to select messages to be sent to the buffered log. Selection can be based on the priority/ severity of the message, the program that generated the message, the logging facility used, a sub-string within the message or a combination of some or all of these.

The **no** variant of this command removes the corresponding filter, so that the specified messages are no longer sent to the buffered log.

Syntax `log buffered [level <level>] [program <program-name>] [facility <facility>] [msgtext <text-string>]`
`no log buffered [level <level>] [program <program-name>] [facility <facility>] [msgtext <text-string>]`

Parameter	Description
level	Filter messages to the buffered log by severity level.
<level>	The minimum severity of message to send to the buffered log. The level can be specified as one of the following numbers or level names, where 0 is the highest severity and 7 is the lowest severity:
0 emergencies	System is unusable
1 alerts	Action must be taken immediately
2 critical	Critical conditions
3 errors	Error conditions
4 warnings	Warning conditions
5 notices	Normal, but significant, conditions
6 informational	Informational messages
7 debugging	Debug-level messages
program	Filter messages to the buffered log by program. Include messages from a specified program in the buffered log.
<program-name>	The name of a program to log messages from. You can enter either one of the following predefined program names (depending on your device model), or another program name that you find in the log output. The pre-defined names are not case sensitive but other program names from the log output are.
rip	Routing Information Protocol (RIP)
ripng	Routing Information Protocol - next generation (RIPng)
ospf	Open Shortest Path First (OSPF)
ospfv3	Open Shortest Path First (OSPF) version 3 (OSPFv3)
bgp	Border Gateway Protocol (BGP)
rsvp	Resource Reservation Protocol (RSVP)
pim-dm	Protocol Independent Multicast - Dense Mode (PIM-DM)

Parameter	Description
pim-sm	Protocol Independent Multicast - Sparse Mode (PIM-SM)
pim-smv6	PIM-SM version 6 (PIM-SMv6)
dot1x	IEEE 802.1X Port-Based Access Control
lacp	Link Aggregation Control Protocol (LACP)
stp	Spanning Tree Protocol (STP)
rstp	Rapid Spanning Tree Protocol (RSTP)
mstp	Multiple Spanning Tree Protocol (MSTP)
imi	Integrated Management Interface (IMI)
imish	Integrated Management Interface Shell (IMISH)
epsr	Ethernet Protection Switched Rings (EPSR)
irdp	ICMP Router Discovery Protocol (IRDP)
rmon	Remote Monitoring
loopprot	Loop Protection
poe	Power-inline (Power over Ethernet)
dhcpsn	DHCP snooping (DHCP SN)
facility	Filter messages to the buffered log by syslog facility.
<facility>	Specify one of the following syslog facilities to include messages from in the buffered log:
kern	Kernel messages
user	Random user-level messages
mail	Mail system
daemon	System daemons
auth	Security/authorization messages
syslog	Messages generated internally by syslogd
lpr	Line printer subsystem
news	Network news subsystem
uucp	UUCP subsystem
cron	Clock daemon
authpriv	Security/authorization messages (private)
ftp	FTP daemon
msgtext	Select messages containing a certain text string.
<text-string>	A text string to match (maximum 128 characters). This is case sensitive, and must be the last text on the command line.

Default By default the buffered log has a filter to select messages whose severity level is “notices (5)” or higher. This filter may be removed using the **no** variant of this command.

Mode Global Configuration

Examples To add a filter to send all messages containing the text “Bridging initialization” to the buffered log, use the following commands:

```
awplus# configure terminal
awplus(config)# log buffered msgtext Bridging initialization
```

To remove a filter that sends all messages containing the text “Bridging initialization” to the buffered log, use the following commands:

```
awplus# configure terminal
awplus(config)# no log buffered msgtext Bridging initialization
```

Related commands

- [clear log buffered](#)
- [default log buffered](#)
- [log buffered](#)
- [log buffered size](#)
- [log buffered exclude](#)
- [show log](#)
- [show log config](#)

log buffered exclude

Overview Use this command to exclude specified log messages from the buffered log. You can exclude messages on the basis of:

- the priority/severity of the message
- the program that generated the message
- the logging facility used
- a sub-string within the message, or
- a combination of some or all of these.

Use the **no** variant of this command to stop excluding the specified messages.

Syntax `log buffered exclude [level <level>] [program <program-name>] [facility <facility>] [msgtext <text-string>]`
`no log buffered exclude [level <level>] [program <program-name>] [facility <facility>] [msgtext <text-string>]`

Parameter	Description
level	Exclude messages of the specified severity level.
<level>	The severity level to exclude. The level can be specified as one of the following numbers or level names, where 0 is the highest severity and 7 is the lowest severity:
0 emergencies	System is unusable
1 alerts	Action must be taken immediately
2 critical	Critical conditions
3 errors	Error conditions
4 warnings	Warning conditions
5 notices	Normal, but significant, conditions
6 informational	Informational messages
7 debugging	Debug-level messages
program	Exclude messages from a specified program.
<program-name>	The name of a program. You can enter either one of the following predefined program names (depending on your device model), or another program name that you find in the log output. The pre-defined names are not case sensitive but other program names from the log output are.
rip	Routing Information Protocol (RIP)
ripng	Routing Information Protocol - next generation (RIPng)
ospf	Open Shortest Path First (OSPF)
ospfv3	Open Shortest Path First (OSPF) version 3 (OSPFv3)
bgp	Border Gateway Protocol (BGP)

Parameter	Description
rsvp	Resource Reservation Protocol (RSVP)
pim-dm	Protocol Independent Multicast - Dense Mode (PIM-DM)
pim-sm	Protocol Independent Multicast - Sparse Mode (PIM-SM)
pim-smv6	PIM-SM version 6 (PIM-SMv6)
dot1x	IEEE 802.1X Port-Based Access Control
lacp	Link Aggregation Control Protocol (LACP)
stp	Spanning Tree Protocol (STP)
rstp	Rapid Spanning Tree Protocol (RSTP)
mstp	Multiple Spanning Tree Protocol (MSTP)
imi	Integrated Management Interface (IMI)
imish	Integrated Management Interface Shell (IMISH)
epsr	Ethernet Protection Switched Rings (EPSR)
irdp	ICMP Router Discovery Protocol (IRDP)
rmon	Remote Monitoring
loopprot	Loop Protection
poe	Power-inline (Power over Ethernet)
dhcpsn	DHCP snooping (DHPCPSN)
facility	Exclude messages from a syslog facility.
<facility>	Specify one of the following syslog facilities to exclude messages from:
kern	Kernel messages
user	Random user-level messages
mail	Mail system
daemon	System daemons
auth	Security/authorization messages
syslog	Messages generated internally by syslogd
lpr	Line printer subsystem
news	Network news subsystem
uucp	UUCP subsystem
cron	Clock daemon
authpriv	Security/authorization messages (private)
ftp	FTP daemon
msgtext	Exclude messages containing a certain text string.
<text-string>	A text string to match (maximum 128 characters). This is case sensitive, and must be the last text on the command line.

Default No log messages are excluded

Mode Global configuration

Example To remove messages that contain the string “example of irrelevant message”, use the following commands:

```
awplus# configure terminal
awplus(config)# log buffered exclude msgtext example of
irrelevant message
```

Related commands

- clear log buffered
- default log buffered
- log buffered
- log buffered (filter)
- log buffered size
- show log
- show log config

log buffered size

Overview This command configures the amount of memory that the buffered log is permitted to use. Once this memory allocation has been filled old messages will be deleted to make room for new messages.

Use the **no** variant of this command to return to the default.

Syntax `log buffered size <50-250>`
`no log buffered size`

Parameter	Description
<50-250>	Size of the RAM log in kilobytes

Default 50 kilobytes

Mode Global Configuration

Example To allow the buffered log to use up to 100 kilobytes of RAM, use the commands:

```
awplus# configure terminal
awplus(config)# log buffered size 100
```

To return to the default value, use the commands:

```
awplus# configure terminal
awplus(config)# no log buffered size
```

Related commands

- [clear log buffered](#)
- [copy buffered-log](#)
- [default log buffered](#)
- [log buffered](#)
- [log buffered \(filter\)](#)
- [log buffered exclude](#)
- [show log](#)
- [show log config](#)

log console

Overview This command configures the device to send log messages to consoles. The console log is configured by default to send messages to the device's main console port.

Use the **no** variant of this command to configure the device not to send log messages to consoles.

Syntax `log console`
`no log console`

Mode Global Configuration

Examples To configure the device to send log messages use the following commands:

```
awplus# configure terminal
awplus(config)# log console
```

To configure the device not to send log messages in all consoles use the following commands:

```
awplus# configure terminal
awplus(config)# no log console
```

Related commands [default log console](#)
[log console \(filter\)](#)
[log console exclude](#)
[show log config](#)

log console (filter)

Overview This command creates a filter to select messages to be sent to all consoles when the **log console** command is given. Selection can be based on the priority/severity of the message, the program that generated the message, the logging facility used, a sub-string within the message or a combination of some or all of these.

Syntax `log console [level <level>] [program <program-name>] [facility <facility>] [msgtext <text-string>]`
`no log console [level <level>] [program <program-name>] [facility <facility>] [msgtext <text-string>]`

Parameter	Description
level	Filter messages by severity level.
<level>	The minimum severity of message to send. The level can be specified as one of the following numbers or level names, where 0 is the highest severity and 7 is the lowest severity:
0 emergencies	System is unusable
1 alerts	Action must be taken immediately
2 critical	Critical conditions
3 errors	Error conditions
4 warnings	Warning conditions
5 notices	Normal, but significant, conditions
6 informational	Informational messages
7 debugging	Debug-level messages
program	Filter messages by program. Include messages from a specified program.
<program-name>	The name of a program to log messages from. You can enter either one of the following predefined program names (depending on your device model), or another program name that you find in the log output. The pre-defined names are not case sensitive but other program names from the log output are.
rip	Routing Information Protocol (RIP)
ripng	Routing Information Protocol - next generation (RIPng)
ospf	Open Shortest Path First (OSPF)
ospfv3	Open Shortest Path First (OSPF) version 3 (OSPFv3)
bgp	Border Gateway Protocol (BGP)
rsvp	Resource Reservation Protocol (RSVP)
pim-dm	Protocol Independent Multicast - Dense Mode (PIM-DM)
pim-sm	Protocol Independent Multicast - Sparse Mode (PIM-SM)
pim-smv6	PIM-SM version 6 (PIM-SMv6)

Parameter	Description
dot1x	IEEE 802.1X Port-Based Access Control
lacp	Link Aggregation Control Protocol (LACP)
stp	Spanning Tree Protocol (STP)
rstp	Rapid Spanning Tree Protocol (RSTP)
mstp	Multiple Spanning Tree Protocol (MSTP)
imi	Integrated Management Interface (IMI)
imish	Integrated Management Interface Shell (IMISH)
epsr	Ethernet Protection Switched Rings (EPSR)
irdp	ICMP Router Discovery Protocol (IRDP)
rmon	Remote Monitoring
loopprot	Loop Protection
poe	Power-inline (Power over Ethernet)
dhcpcsn	DHCP snooping (DHPCPSN)
facility	Filter messages by syslog facility.
<facility>	Specify one of the following syslog facilities to include messages from:
kern	Kernel messages
user	Random user-level messages
mail	Mail system
daemon	System daemons
auth	Security/authorization messages
syslog	Messages generated internally by syslogd
lpr	Line printer subsystem
news	Network news subsystem
uucp	UUCP subsystem
cron	Clock daemon
authpriv	Security/authorization messages (private)
ftp	FTP daemon
msgtext	Select messages containing a certain text string.
<text-string>	A text string to match (maximum 128 characters). This is case sensitive, and must be the last text on the command line.

Default By default the console log has a filter to select messages whose severity level is `critical` or higher. This filter may be removed using the **no** variant of this command. This filter may be removed and replaced by filters that are more selective.

Mode Global Configuration

Examples To create a filter to send all messages containing the text "Bridging initialization" to console instances where the **log console** command has been entered, use the following commands:

```
awplus# configure terminal
awplus(config)# log console msgtext "Bridging initialization"
```

To remove a default filter that includes sending **critical**, **alert** and **emergency** level messages to the console, use the following commands:

```
awplus# configure terminal
awplus(config)# no log console level critical
```

Related commands

- default log console
- log console
- log console exclude
- show log config

log console exclude

Overview Use this command to prevent specified log messages from being sent to the console, when console logging is turned on. You can exclude messages on the basis of:

- the priority/severity of the message
- the program that generated the message
- the logging facility used
- a sub-string within the message, or
- a combination of some or all of these.

Use the **no** variant of this command to stop excluding the specified messages.

Syntax `log console exclude [level <level>] [program <program-name>]
[facility <facility>] [msgtext <text-string>]`
`no log console exclude [level <level>] [program <program-name>]
[facility <facility>] [msgtext <text-string>]`

Parameter	Description
level	Exclude messages of the specified severity level.
<level>	The severity level to exclude. The level can be specified as one of the following numbers or level names, where 0 is the highest severity and 7 is the lowest severity:
	0 emergencies System is unusable
	1 alerts Action must be taken immediately
	2 critical Critical conditions
	3 errors Error conditions
	4 warnings Warning conditions
	5 notices Normal, but significant, conditions
	6 informational Informational messages
	7 debugging Debug-level messages
program	Exclude messages from a specified program.
<program-name>	The name of a program. You can enter either one of the following predefined program names (depending on your device model), or another program name that you find in the log output. The pre-defined names are not case sensitive but other program names from the log output are.
	rip Routing Information Protocol (RIP)
	ripng Routing Information Protocol - next generation (RIPng)
	ospf Open Shortest Path First (OSPF)
	ospfv3 Open Shortest Path First (OSPF) version 3 (OSPFv3)

Parameter	Description
bgp	Border Gateway Protocol (BGP)
rsvp	Resource Reservation Protocol (RSVP)
pim-dm	Protocol Independent Multicast - Dense Mode (PIM-DM)
pim-sm	Protocol Independent Multicast - Sparse Mode (PIM-SM)
pim-smv6	PIM-SM version 6 (PIM-SMv6)
dot1x	IEEE 802.1X Port-Based Access Control
lacp	Link Aggregation Control Protocol (LACP)
stp	Spanning Tree Protocol (STP)
rstp	Rapid Spanning Tree Protocol (RSTP)
mstp	Multiple Spanning Tree Protocol (MSTP)
imi	Integrated Management Interface (IMI)
imish	Integrated Management Interface Shell (IMISH)
epsr	Ethernet Protection Switched Rings (EPSR)
irdp	ICMP Router Discovery Protocol (IRDP)
rmon	Remote Monitoring
loopprot	Loop Protection
poe	Power-inline (Power over Ethernet)
dhcpsn	DHCP snooping (DHCP SN)
facility	Exclude messages from a syslog facility.
<facility>	Specify one of the following syslog facilities to exclude messages from:
kern	Kernel messages
user	Random user-level messages
mail	Mail system
daemon	System daemons
auth	Security/authorization messages
syslog	Messages generated internally by syslogd
lpr	Line printer subsystem
news	Network news subsystem
uucp	UUCP subsystem
cron	Clock daemon
authpriv	Security/authorization messages (private)
ftp	FTP daemon

Parameter	Description
msgtext	Exclude messages containing a certain text string.
<text-string>	A text string to match (maximum 128 characters). This is case sensitive, and must be the last text on the command line.

Default No log messages are excluded

Mode Global configuration

Example To remove messages that contain the string “example of irrelevant message”, use the following commands:

```
awplus# configure terminal
awplus(config)# log console exclude msgtext example of
irrelevant message
```

Related commands

- [default log console](#)
- [log console](#)
- [log console \(filter\)](#)
- [show log config](#)

log date-format

Overview Use this command to change the date format for log messages to an ISO 8601 compliant format, or to return to the default date format.

Syntax `log date-format {iso|default}`

Parameter	Description
iso	Display the date and time in the ISO 8601 compliant format of: YYYY-MM-DDThh:mm:ssTZD
default	Display the date and time in the default date format of YYYY MMM DD HH:MM:SS

Default The default option of YYYY MMM DD HH:MM:SS (except when using terminal monitor, when it is HH:MM:SS)

Mode Global Configuration

Usage notes In the ISO 8601 compliant format, a T separates the date from the time, and the time is followed by the timezone offset from UTC time. For example, this is a log message with an ISO 8601 compliant date:

```
2016-09-29T08:55:43+13:00 user.notice Gateway IMISH[1983]:  
[manager@ttyS0]show run
```

This is a log message with the default date format:

```
2016 Sep 29 08:55:43 user.notice Gateway IMISH[1983]:  
[manager@ttyS0]show run
```

The date format setting affects all log messages, no matter where the messages are stored or displayed.

Examples To set the date format to the ISO 8601 compliant format, use the commands:

```
awplus# configure terminal  
awplus(config)# log date-format iso
```

To return to the default date format of YYYY MMM DD HH:MM:SS, use the commands:

```
awplus# configure terminal  
awplus(config)# log date-format default
```

Related commands [show exception log](#)
[show log](#)
[show log permanent](#)

Command changes Version 5.4.6-2.1: command added

log email

Overview This command configures the device to send log messages to an email address. The email address is specified in this command.

Syntax `log email <email-address>`

Parameter	Description
<code><email-address></code>	The email address to send log messages to

Default By default no filters are defined for email log targets. Filters must be defined before messages will be sent.

Mode Global Configuration

Example To have log messages emailed to the email address `admin@alliedtelesis.com` use the following commands:

```
awplus# configure terminal
awplus(config)# log email admin@alliedtelesis.com
```

Related commands

- [default log email](#)
- [log email \(filter\)](#)
- [log email exclude](#)
- [log email time](#)
- [show log config](#)

log email (filter)

Overview This command creates a filter to select messages to be sent to an email address. Selection can be based on the priority/ severity of the message, the program that generated the message, the logging facility used, a sub-string within the message or a combination of some or all of these.

The **no** variant of this command configures the device to no longer send log messages to a specified email address. All configuration relating to this log target will be removed.

Syntax

```
log email <email-address> [level <level>] [program
<program-name>] [facility <facility>] [msgtext <text-string>]
no log email <email-address> [level <level>] [program
<program-name>] [facility <facility>] [msgtext <text-string>]
```

Parameter	Description
<email-address>	The email address to send logging messages to
level	Filter messages by severity level.
<level>	The minimum severity of message to send. The level can be specified as one of the following numbers or level names, where 0 is the highest severity and 7 is the lowest severity:
0 emergencies	System is unusable
1 alerts	Action must be taken immediately
2 critical	Critical conditions
3 errors	Error conditions
4 warnings	Warning conditions
5 notices	Normal, but significant, conditions
6 informational	Informational messages
7 debugging	Debug-level messages
program	Filter messages by program. Include messages from a specified program.
<program-name>	The name of a program to log messages from. You can enter either one of the following predefined program names (depending on your device model), or another program name that you find in the log output. The pre-defined names are not case sensitive but other program names from the log output are.
rip	Routing Information Protocol (RIP)
ripng	Routing Information Protocol - next generation (RIPng)
ospf	Open Shortest Path First (OSPF)
ospfv3	Open Shortest Path First (OSPF) version 3 (OSPFv3)
bgp	Border Gateway Protocol (BGP)

Parameter	Description
rsvp	Resource Reservation Protocol (RSVP)
pim-dm	Protocol Independent Multicast - Dense Mode (PIM-DM)
pim-sm	Protocol Independent Multicast - Sparse Mode (PIM-SM)
pim-smv6	PIM-SM version 6 (PIM-SMv6)
dot1x	IEEE 802.1X Port-Based Access Control
lacp	Link Aggregation Control Protocol (LACP)
stp	Spanning Tree Protocol (STP)
rstp	Rapid Spanning Tree Protocol (RSTP)
mstp	Multiple Spanning Tree Protocol (MSTP)
imi	Integrated Management Interface (IMI)
imish	Integrated Management Interface Shell (IMISH)
epsr	Ethernet Protection Switched Rings (EPSR)
irdp	ICMP Router Discovery Protocol (IRDP)
rmon	Remote Monitoring
loopprot	Loop Protection
poe	Power-inline (Power over Ethernet)
dhcpcsn	DHCP snooping (DHPCPSN)
facility	Filter messages by syslog facility.
<facility>	Specify one of the following syslog facilities to include messages from:
kern	Kernel messages
user	Random user-level messages
mail	Mail system
daemon	System daemons
auth	Security/authorization messages
syslog	Messages generated internally by syslogd
lpr	Line printer subsystem
news	Network news subsystem
uucp	UUCP subsystem
cron	Clock daemon
authpriv	Security/authorization messages (private)
ftp	FTP daemon
msgtext	Select messages containing a certain text string.
<text-string>	A text string to match (maximum 128 characters). This is case sensitive, and must be the last text on the command line.

Mode Global Configuration

Examples To create a filter to send all messages containing the text "Bridging initialization", to the email address admin@homebase.com, use the following commands:

```
awplus# configure terminal
awplus(config)# log email admin@homebase.com msgtext "Bridging
initialization"
```

To create a filter to send messages with a severity level of **informational** and above to the email address admin@alliedtelesis.com, use the following commands:

```
awplus# configure terminal
awplus(config)# log email admin@alliedtelesis.com level
informational
```

To stop the device emailing log messages emailed to the email address admin@alliedtelesis.com, use the following commands:

```
awplus# configure terminal
awplus(config)# no log email admin@homebase.com
```

To remove a filter that sends messages with a severity level of **informational** and above to the email address admin@alliedtelesis.com, use the following commands:

```
awplus# configure terminal
awplus(config)# no log email admin@alliedtelesis.com level
informational
```

Related commands

- [default log email](#)
- [log email](#)
- [log email exclude](#)
- [log email time](#)
- [show log config](#)

log email exclude

Overview Use this command to prevent specified log messages from being emailed, when the device is configured to send log messages to an email address. You can exclude messages on the basis of:

- the priority/severity of the message
- the program that generated the message
- the logging facility used
- a sub-string within the message, or
- a combination of some or all of these.

Use the **no** variant of this command to stop excluding the specified messages.

Syntax `log email exclude [level <level>] [program <program-name>]
[facility <facility>] [msgtext <text-string>]`
`no log email exclude [level <level>] [program <program-name>]
[facility <facility>] [msgtext <text-string>]`

Parameter	Description
level	Exclude messages of the specified severity level.
<level>	The severity level to exclude. The level can be specified as one of the following numbers or level names, where 0 is the highest severity and 7 is the lowest severity:
0 emergencies	System is unusable
1 alerts	Action must be taken immediately
2 critical	Critical conditions
3 errors	Error conditions
4 warnings	Warning conditions
5 notices	Normal, but significant, conditions
6 informational	Informational messages
7 debugging	Debug-level messages
program	Exclude messages from a specified program.
<program-name>	The name of a program. You can enter either one of the following predefined program names (depending on your device model), or another program name that you find in the log output. The pre-defined names are not case sensitive but other program names from the log output are.
rip	Routing Information Protocol (RIP)
ripng	Routing Information Protocol - next generation (RIPng)
ospf	Open Shortest Path First (OSPF)
ospfv3	Open Shortest Path First (OSPF) version 3 (OSPFv3)

Parameter	Description
bgp	Border Gateway Protocol (BGP)
rsvp	Resource Reservation Protocol (RSVP)
pim-dm	Protocol Independent Multicast - Dense Mode (PIM-DM)
pim-sm	Protocol Independent Multicast - Sparse Mode (PIM-SM)
pim-smv6	PIM-SM version 6 (PIM-SMv6)
dot1x	IEEE 802.1X Port-Based Access Control
lacp	Link Aggregation Control Protocol (LACP)
stp	Spanning Tree Protocol (STP)
rstp	Rapid Spanning Tree Protocol (RSTP)
mstp	Multiple Spanning Tree Protocol (MSTP)
imi	Integrated Management Interface (IMI)
imish	Integrated Management Interface Shell (IMISH)
epsr	Ethernet Protection Switched Rings (EPSR)
irdp	ICMP Router Discovery Protocol (IRDP)
rmon	Remote Monitoring
loopprot	Loop Protection
poe	Power-inline (Power over Ethernet)
dhcpsn	DHCP snooping (DHCP SN)
facility	Exclude messages from a syslog facility.
<facility>	Specify one of the following syslog facilities to exclude messages from:
kern	Kernel messages
user	Random user-level messages
mail	Mail system
daemon	System daemons
auth	Security/authorization messages
syslog	Messages generated internally by syslogd
lpr	Line printer subsystem
news	Network news subsystem
uucp	UUCP subsystem
cron	Clock daemon
authpriv	Security/authorization messages (private)
ftp	FTP daemon

Parameter	Description
msgtext	Exclude messages containing a certain text string.
<text-string>	A text string to match (maximum 128 characters). This is case sensitive, and must be the last text on the command line.

Default No log messages are excluded

Mode Global configuration

Example To remove messages that contain the string “example of irrelevant message”, use the following commands:

```
awplus# configure terminal
awplus(config)# log email exclude msgtext example of irrelevant
message
```

Related commands

- [default log email](#)
- [log email](#)
- [log email \(filter\)](#)
- [log email time](#)
- [show log config](#)

log email time

Overview This command configures the time used in messages sent to an email address. If the syslog server is in a different time zone to your device then the time offset can be configured using either the **utc-offset** parameter option keyword or the **local-offset** parameter option keyword, where **utc-offset** is the time difference from UTC (Universal Time, Coordinated) and **local-offset** is the difference from local time.

Syntax `log email <email-address> time {local|local-offset|utc-offset {plus|minus}<0-24>}`

Parameter	Description
<email-address>	The email address to send log messages to
time	Specify the time difference between the email recipient and the device you are configuring.
local	The device is in the same time zone as the email recipient
local-offset	The device is in a different time zone to the email recipient. Use the plus or minus keywords and specify the difference (offset) from local time of the device to the email recipient in hours.
utc-offset	The device is in a different time zone to the email recipient. Use the plus or minus keywords and specify the difference (offset) from UTC time of the device to the email recipient in hours.
plus	Negative offset (difference) from the device to the email recipient.
minus	Positive offset (difference) from the device to the email recipient.
<0-24>	World Time zone offset in hours

Default The default is **local** time.

Mode Global Configuration

Usage notes Use the **local** option if the email recipient is in the same time zone as this device. Messages will display the time as on the local device when the message was generated.

Use the **offset** option if the email recipient is in a different time zone to this device. Specify the time offset of the email recipient in hours. Messages will display the time they were generated on this device but converted to the time zone of the email recipient.

Examples To send messages to the email address `test@home.com` in the same time zone as the device's local time zone, use the following commands:

```
awplus# configure terminal
awplus(config)# log email admin@base.com time local 0
```

To send messages to the email address `admin@base.com` with the time information converted to the time zone of the email recipient, which is 3 hours ahead of the device's local time zone, use the following commands:

```
awplus# configure terminal
awplus(config)# log email admin@base.com time local-offset plus
3
```

To send messages to the email address `user@remote.com` with the time information converted to the time zone of the email recipient, which is 3 hours behind the device's UTC time zone, use the following commands:

```
awplus# configure terminal
awplus(config)# log email user@remote.com time utc-offset minus
3
```

Related commands

- [default log email](#)
- [log email](#)
- [log email \(filter\)](#)
- [log email exclude](#)
- [show log config](#)

log external

Overview Use this command to enable external logging. External logging sends syslog messages to a file on a USB storage device.

If the file does not already exist on the storage device, it (and any specified subdirectory) will be automatically created. If the file already exists, messages are appended to it.

Use the **no** variant of this command to disable external logging.

Syntax `log external <filename>`
`no log external`

Parameter	Description
<code><filename></code>	The file and optionally directory path to store the log messages in. See Introduction on page 152 for valid syntax.

Default External logging is disabled by default.

Mode Global Configuration

Usage notes We strongly recommend using ext3 or ext4 as the file system on the external storage device. These file systems have a lower risk of file corruption occurring if the switch or firewall loses power.

You should also unmount the storage device before removing it from the switch or firewall, to avoid corrupting the log file. To unmount the device, use the **unmount** command.

Example To save messages to a file called "messages.log" in a directory called "log" on a USB storage device, use the command:

```
awplus# configure terminal
awplus(config)# log external usb:/log/messages.log
```

Related commands

- [clear log external](#)
- [default log external](#)
- [log external \(filter\)](#)
- [log external exclude](#)
- [log external rotate](#)
- [log external size](#)
- [show log config](#)
- [show log external](#)
- [unmount](#)

Command changes Version 5.4.7-1.1: command added

log external (filter)

Overview Use this command to create a filter to select messages to be sent to the external log. You can include messages based on:

- the priority/severity of the message
- the program that generated the message
- the logging facility used
- a sub-string within the message, or
- a combination of some or all of these.

The **no** variant of this command removes the corresponding filter, so that the specified messages are no longer sent to the external log.

Syntax `log external [level <level>] [program <program-name>] [facility <facility>] [msgtext <text-string>]`
`no log external [level <level>] [program <program-name>] [facility <facility>] [msgtext <text-string>]`

Parameter	Description
level	Filter messages to the external log by severity level.
<level>	The minimum severity of message to send to the external log. The level can be specified as one of the following numbers or level names, where 0 is the highest severity and 7 is the lowest severity:
0 emergencies	System is unusable
1 alerts	Action must be taken immediately
2 critical	Critical conditions
3 errors	Error conditions
4 warnings	Warning conditions
5 notices	Normal, but significant, conditions
6 informational	Informational messages
7 debugging	Debug-level messages
program	Filter messages to the external log by program. Include messages from a specified program in the external log.
<program-name>	The name of a program to log messages from. You can enter either one of the following predefined program names (depending on your device model), or another program name that you find in the log output. The pre-defined names are not case sensitive but other program names from the log output are.
rip	Routing Information Protocol (RIP)
ripng	Routing Information Protocol - next generation (RIPng)
ospf	Open Shortest Path First (OSPF)

Parameter	Description
ospfv3	Open Shortest Path First (OSPF) version 3 (OSPFv3)
bgp	Border Gateway Protocol (BGP)
rsvp	Resource Reservation Protocol (RSVP)
pim-dm	Protocol Independent Multicast - Dense Mode (PIM-DM)
pim-sm	Protocol Independent Multicast - Sparse Mode (PIM-SM)
pim-smv6	PIM-SM version 6 (PIM-SMv6)
dot1x	IEEE 802.1X Port-Based Access Control
lacp	Link Aggregation Control Protocol (LACP)
stp	Spanning Tree Protocol (STP)
rstp	Rapid Spanning Tree Protocol (RSTP)
mstp	Multiple Spanning Tree Protocol (MSTP)
imi	Integrated Management Interface (IMI)
imish	Integrated Management Interface Shell (IMISH)
epsr	Ethernet Protection Switched Rings (EPSR)
irdp	ICMP Router Discovery Protocol (IRDP)
rmon	Remote Monitoring
loopprot	Loop Protection
poe	Power-inline (Power over Ethernet)
dhcpcsn	DHCP snooping (DHCP SN)
facility	Filter messages to the external log by syslog facility.
<facility>	Specify one of the following syslog facilities to include messages from in the log:
kern	Kernel messages
user	Random user-level messages
mail	Mail system
daemon	System daemons
auth	Security/authorization messages
syslog	Messages generated internally by syslogd
lpr	Line printer subsystem
news	Network news subsystem
uucp	UUCP subsystem
cron	Clock daemon
authpriv	Security/authorization messages (private)
ftp	FTP daemon

Parameter	Description
msgtext	Select messages containing a certain text string.
<text-string>	A text string to match (maximum 128 characters). This is case sensitive, and must be the last text on the command line.

Default By default the external log has a filter to select messages whose severity level is “notices (5)” or higher. This filter may be removed using the **no** variant of this command.

Mode Global Configuration

Examples To add a filter to send all messages containing the text “Bridging initialization” to the external log, use the following commands:

```
awplus# configure terminal
awplus(config)# log external msgtext Bridging initialization
```

To remove a filter that sends all messages containing the text “Bridging initialization” to the external log, use the following commands:

```
awplus# configure terminal
awplus(config)# no log external msgtext Bridging initialization
```

Related commands

- clear log external
- default log external
- log external
- log external exclude
- log external rotate
- log external size
- show log config
- show log external
- unmount

Command changes Version 5.4.7-1.1: command added

log external exclude

Overview Use this command to exclude specified log messages from the external log. You can exclude messages on the basis of:

- the priority/severity of the message
- the program that generated the message
- the logging facility used
- a sub-string within the message, or
- a combination of some or all of these.

Use the **no** variant of this command to stop excluding the specified messages.

Syntax `log external exclude [level <level>] [program <program-name>] [facility <facility>] [msgtext <text-string>]`
`no log external exclude [level <level>] [program <program-name>] [facility <facility>] [msgtext <text-string>]`

Parameter	Description
level	Exclude messages of the specified severity level.
<level>	The severity level to exclude. The level can be specified as one of the following numbers or level names, where 0 is the highest severity and 7 is the lowest severity:
0 emergencies	System is unusable
1 alerts	Action must be taken immediately
2 critical	Critical conditions
3 errors	Error conditions
4 warnings	Warning conditions
5 notices	Normal, but significant, conditions
6 informational	Informational messages
7 debugging	Debug-level messages
program	Exclude messages from a specified program.
<program-name>	The name of a program. You can enter either one of the following predefined program names (depending on your device model), or another program name that you find in the log output. The pre-defined names are not case sensitive but other program names from the log output are.
rip	Routing Information Protocol (RIP)
ripng	Routing Information Protocol - next generation (RIPng)
ospf	Open Shortest Path First (OSPF)
ospfv3	Open Shortest Path First (OSPF) version 3 (OSPFv3)
bgp	Border Gateway Protocol (BGP)

Parameter	Description
rsvp	Resource Reservation Protocol (RSVP)
pim-dm	Protocol Independent Multicast - Dense Mode (PIM-DM)
pim-sm	Protocol Independent Multicast - Sparse Mode (PIM-SM)
pim-smv6	PIM-SM version 6 (PIM-SMv6)
dot1x	IEEE 802.1X Port-Based Access Control
lacp	Link Aggregation Control Protocol (LACP)
stp	Spanning Tree Protocol (STP)
rstp	Rapid Spanning Tree Protocol (RSTP)
mstp	Multiple Spanning Tree Protocol (MSTP)
imi	Integrated Management Interface (IMI)
imish	Integrated Management Interface Shell (IMISH)
epsr	Ethernet Protection Switched Rings (EPSR)
irdp	ICMP Router Discovery Protocol (IRDP)
rmon	Remote Monitoring
loopprot	Loop Protection
poe	Power-inline (Power over Ethernet)
dhcpsn	DHCP snooping (DHPCPSN)
facility	Exclude messages from a syslog facility.
<facility>	Specify one of the following syslog facilities to exclude messages from:
kern	Kernel messages
user	Random user-level messages
mail	Mail system
daemon	System daemons
auth	Security/authorization messages
syslog	Messages generated internally by syslogd
lpr	Line printer subsystem
news	Network news subsystem
uucp	UUCP subsystem
cron	Clock daemon
authpriv	Security/authorization messages (private)
ftp	FTP daemon
msgtext	Exclude messages containing a certain text string.
<text-string>	A text string to match (maximum 128 characters). This is case sensitive, and must be the last text on the command line.

Default No log messages are excluded

Mode Global Configuration

Example To remove messages that contain the string “example of irrelevant message”, use the following commands:

```
awplus# configure terminal
awplus(config)# log external exclude msgtext example of
irrelevant message
```

**Related
commands** [clear log external](#)
[default log external](#)

[log external](#)

[log external \(filter\)](#)

[log external rotate](#)

[log external size](#)

[show log config](#)

[show log external](#)

[unmount](#)

**Command
changes** Version 5.4.7-1.1: command added

log external rotate

Overview Use this command to configure the number of files that the external log can rotate through.

Use the **no** variant of this command to return to the default.

Syntax `log external rotate <0-255>`
`no log external rotate`

Parameter	Description
<0-255>	The number of additional files to rotate through. Note that the device rotates between the initial file and the number of additional files specified by this value - see the Usage section below.

Default The default is 1, which rotates between the initial file and 1 additional file (for example, rotates between `messages.log` and `messages.log.1`)

Mode Global Configuration

Usage notes The device rotates between the initial file and the number of additional files specified by this command. For example, the diagram below shows how setting rotate to 2 makes the device rotate through 3 files.

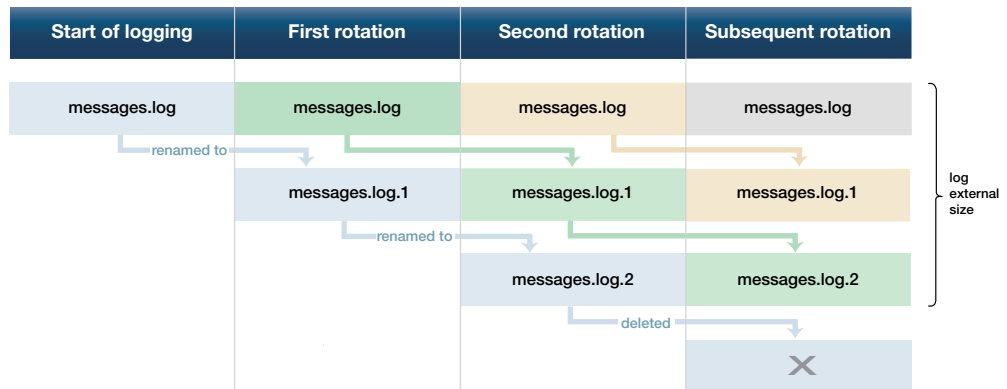

Note that if you set rotate to 0, and the external log file becomes full, then the device deletes the full log file and creates a new (empty) file of the same name to save messages into. For this reason, we recommend setting rotate to at least 1.

Example To set the rotation value to 2, and therefore rotate between 3 files, use the commands:

```
awplus# configure terminal
awplus(config)# log external rotate 2
```

Related commands [clear log external](#)

default log external
log external
log external (filter)
log external exclude
log external size
show log config
show log external
unmount

Command changes Version 5.4.7-1.1: command added

log external size

Overview Use this command to configure the total amount of size that the external log is permitted to use, in kilobytes. The maximum possible depends on the storage device's file system.

Note that if you are rotating between multiple files, this is the maximum size of all files, not of each individual file. For example, if you are rotating between 2 files (**log external rotate 1**), each file will have a maximum size of 25 kBytes by default.

Use the **no** variant of this command to return to the default size.

Syntax `log external size [<50-4194304>]`
`no log external size`

Parameter	Description
<50-4194304>	The total amount of size that the external log is permitted to use, in kilobytes.

Default 50 kBytes

Mode Global Configuration

Example To configure a total log size of 100 kBytes, use the commands:

```
awplus# configure terminal
awplus(config)# log external size 100
```

Related commands

- [clear log external](#)
- [default log external](#)
- [log external](#)
- [log external \(filter\)](#)
- [log external exclude](#)
- [log external rotate](#)
- [log external size](#)
- [show log config](#)
- [show log external](#)
- [unmount](#)

Command changes Version 5.4.7-1.1: command added

log facility

Overview Use this command to assign a facility to all log messages generated on this device. This facility overrides any facility that is automatically generated as part of the log message.

Use the **no** variant of this command to remove the configured facility.

Syntax `log facility {kern|user|mail|daemon|auth|syslog|lpr|news|uucp|cron|authpriv|ftp|local0|local1|local2|local3|local4|local5|local6|local7}`
`no log facility`

Default None. The outgoing syslog facility depends on the log message.

Mode Global Configuration

Usage notes Specifying different facilities for log messages generated on different devices can allow messages from multiple devices sent to a common server to be distinguished from each other.

Ordinarily, the facility values generated in log messages have meanings as shown in the following table. Using this command will override these meanings, and the new meanings will depend on the use you put them to.

Table 8-1: Ordinary meanings of the facility parameter in log messages

Facility	Description
kern	Kernel messages
user	User-level messages
mail	Mail system
daemon	System daemons
auth	Security/authorization messages
syslog	Messages generated internally by the syslog daemon
lpr	Line printer subsystem
news	Network news subsystem
uucp	UNIX-to-UNIX Copy Program subsystem
cron	Clock daemon
authpriv	Security/authorization (private) messages

Table 8-1: Ordinary meanings of the facility parameter in log messages (cont.)

Facility	Description
ftp	FTP daemon
local<0..7>	The facility labels above have specific meanings, while the local facility labels are intended to be put to local use. In AlliedWare Plus, some of these local facility labels are used in log messages. In particular, local5 is assigned to log messages generated by UTM Firewall security features.

Example To specify a facility of local6, use the following commands:

```
awplus# configure terminal  
awplus(config)# log facility local6
```

Related commands [show log config](#)

log host

Overview This command configures the device to send log messages to a remote syslog server via UDP port 514. The IP address of the remote server must be specified. By default no filters are defined for remote syslog servers. Filters must be defined before messages will be sent.

Use the **no** variant of this command to stop sending log messages to the remote syslog server.

Syntax `log host <ipv4-addr> [secure]`
`log host <ipv6-addr>`
`no log host <ipv4-addr>|<ipv6-addr>`

Syntax (VRF-lite) `log host <ipv4-addr> [vrf <vrf-name>] [secure]`
`log host <ipv6-addr> [vrf <vrf-name>]`
`no log host <ipv4-addr>|<ipv6-addr> [vrf <vrf-name>]`

Parameter	Description
<code><ipv4-addr></code>	Specify the source IPv4 address, in dotted decimal notation (A.B.C.D).
<code><ipv6-addr></code>	Specify the source IPv6 address, in X:X::X:X notation.
<code>vrf</code> <code><vrf-name></code>	The name of a VRF instance. Use this to specify the VRF that the remote syslog server (host) is accessible by. Hosts are uniquely identified by their address and VRF, so multiple hosts can have the same address as long as the VRF is different. The default is the global VRF.
<code>secure</code>	Optional value to create a secure log destination. This option is only valid for IPv4 hosts.

Mode Global Configuration

Usage notes Use the optional **secure** parameter to configure a secure IPv4 syslog host. For secure hosts, syslog over TLS is used to encrypt the logs. The certificate received from the remote log server must have an issuer chain that terminates with the root CA certificate for any of the trustpoints that are associated with the application.

The remote server may also request that a certificate is transmitted from the local device. In this situation the first trustpoint added to the syslog application will be transmitted to the remote server.

For detailed information about securing syslog, see the [PKI Feature Overview_and Configuration_Guide](#).

Examples To configure the device to send log messages to a remote secure syslog server with IP address 10.32.16.99, use the following commands:

```
awplus# configure terminal
awplus(config)# log host 10.32.16.99 secure
```

To stop the device from sending log messages to the remote syslog server with IP address 10.32.16.99, use the following commands:

```
awplus# configure terminal
awplus(config)# no log host 10.32.16.99
```

Example (VRF-lite) To configure the device to send log messages to a remote syslog server that is accessible via VRF 'red', use the following commands:

```
awplus# configure terminal
awplus(config)# log host 10.32.16.99 vrf red
```

Related commands

default log host
log host (filter)
log host exclude
log host source
log host startup-delay
log host time
log trustpoint
show log config

Command changes Version 5.5.2-1.1: **vrf** parameter added for products that support VRF

log host (filter)

Overview This command creates a filter to select messages to be sent to a remote syslog server. Selection can be based on the priority/severity of the message, the program that generated the message, the logging facility used, a substring within the message or a combination of some or all of these.

The **no** variant of this command configures the device to no longer send log messages to a remote syslog server. The IP address of the syslog server must be specified. All configuration relating to this log target will be removed.

Syntax `log host <ip-addr> [level <level>] [program <program-name>] [facility <facility>] [msgtext <text-string>]`
`no log host <ip-addr> [level <level>] [program <program-name>] [facility <facility>] [msgtext <text-string>]`

Syntax (VRF-lite) `log host <ip-addr> [vrf <vrf-name>] [level <level>] [program <program-name>] [facility <facility>] [msgtext <text-string>]`
`no log host <ip-addr> [vrf <vrf-name>] [level <level>] [program <program-name>] [facility <facility>] [msgtext <text-string>]`

Parameter	Description
<ip-addr>	The IP address of a remote syslog server.
vrf <vrf-name>	The name of a VRF instance. Use this if the syslog server is inside a VRF. The default is the global VRF.
level	Filter messages by severity level.
<level>	The minimum severity of message to send. The level can be specified as one of the following numbers or level names, where 0 is the highest severity and 7 is the lowest severity:
0 emergencies	System is unusable
1 alerts	Action must be taken immediately
2 critical	Critical conditions
3 errors	Error conditions
4 warnings	Warning conditions
5 notices	Normal, but significant, conditions
6 informational	Informational messages
7 debugging	Debug-level messages
program	Filter messages by program. Include messages from a specified program.
<program-name>	The name of a program to log messages from. You can enter either one of the following predefined program names (depending on your device model), or another program name that you find in the log output. The pre-defined names are not case sensitive but other program names from the log output are.
rip	Routing Information Protocol (RIP)

Parameter	Description
ripng	Routing Information Protocol - next generation (RIPng)
ospf	Open Shortest Path First (OSPF)
ospfv3	Open Shortest Path First (OSPF) version 3 (OSPFv3)
bgp	Border Gateway Protocol (BGP)
rsvp	Resource Reservation Protocol (RSVP)
pim-dm	Protocol Independent Multicast - Dense Mode (PIM-DM)
pim-sm	Protocol Independent Multicast - Sparse Mode (PIM-SM)
pim-smv6	PIM-SM version 6 (PIM-SMv6)
dot1x	IEEE 802.1X Port-Based Access Control
lacp	Link Aggregation Control Protocol (LACP)
stp	Spanning Tree Protocol (STP)
rstp	Rapid Spanning Tree Protocol (RSTP)
mstp	Multiple Spanning Tree Protocol (MSTP)
imi	Integrated Management Interface (IMI)
imish	Integrated Management Interface Shell (IMISH)
epsr	Ethernet Protection Switched Rings (EPSR)
irdp	ICMP Router Discovery Protocol (IRDP)
rmon	Remote Monitoring
loopprot	Loop Protection
poe	Power-inline (Power over Ethernet)
dhcpsn	DHCP snooping (DHCP SN)
facility	Filter messages by syslog facility.
<facility>	Specify one of the following syslog facilities to include messages from:
kern	Kernel messages
user	Random user-level messages
mail	Mail system
daemon	System daemons
auth	Security/authorization messages
syslog	Messages generated internally by syslogd
lpr	Line printer subsystem
news	Network news subsystem
uucp	UUCP subsystem
cron	Clock daemon
authpriv	Security/authorization messages (private)

Parameter	Description
	ftp FTP daemon
msgtext	Select messages containing a certain text string.
<text-string>	A text string to match (maximum 128 characters). This is case sensitive, and must be the last text on the command line.

Mode Global Configuration

Examples To create a filter to send all messages containing the text "Bridging initialization", to a remote syslog server with IP address 10.32.16.21, use the following commands:

```
awplus# configure terminal
awplus(config)# log host 10.32.16.21 msgtext "Bridging
initialization"
```

To create a filter to send messages with a severity level of **informational** and above to the syslog server with IP address 10.32.16.21, use the following commands:

```
awplus# configure terminal
awplus(config)# log host 10.32.16.21 level informational
```

To remove a filter that sends all messages containing the text "Bridging initialization", to a remote syslog server with IP address 10.32.16.21, use the following commands:

```
awplus# configure terminal
awplus(config)# no log host 10.32.16.21 msgtext "Bridging
initialization"
```

To remove a filter that sends messages with a severity level of **informational** and above to the syslog server with IP address 10.32.16.21, use the following commands:

```
awplusawpluls# configure terminal
awplus(config)# no log host 10.32.16.21 level informational
```

Example (VRF-lite) To create a filter to send messages with a severity level of **informational** and above to the syslog server with IP address 10.32.16.21, when that server is in VRF 'red', use the following commands:

```
awplus# configure terminal
awplus(config)# log host 10.32.16.21 vrf red level
informational
```

Related commands

- [default log host](#)
- [log host](#)
- [log host exclude](#)
- [log host source](#)

log host time

show log config

**Command
changes**

Version 5.5.2-1.1: **vrf** parameter added for products that support VRF

log host exclude

Overview Use this command to prevent specified log messages from being sent to the remote syslog server, when `log host` is enabled. You can exclude messages on the basis of:

- the priority/severity of the message
- the program that generated the message
- the logging facility used
- a sub-string within the message, or
- a combination of some or all of these.

Use the **no** variant of this command to stop excluding the specified messages.

Syntax

```
log host {<hostname>|<ipv4-addr>|<ipv6-addr>} exclude [level <level>] [program <program-name>] [facility <facility>] [msgtext <text-string>]
no log host {<hostname>|<ipv4-addr>|<ipv6-addr>} exclude [level <level>] [program <program-name>] [facility <facility>] [msgtext <text-string>]
```

Syntax (VRF-lite)

```
log host {<hostname>|<ipv4-addr>|<ipv6-addr>} [vrf <vrf-name>] exclude [level <level>] [program <program-name>] [facility <facility>] [msgtext <text-string>]
no log host {<hostname>|<ipv4-addr>|<ipv6-addr>} [vrf <vrf-name>] exclude [level <level>] [program <program-name>] [facility <facility>] [msgtext <text-string>]
```

Parameter	Description
<code><hostname></code>	The host name of a remote syslog server.
<code><ipv4-addr></code>	The IPv4 address of a remote syslog server, in A.B.C.D format.
<code><ipv6-addr></code>	The IPv6 address of a remote syslog server, in X:X::X:X format.
<code>vrf <vrf-name></code>	The name of a VRF instance. Use this if the syslog server is inside a VRF. The default is the global VRF.
<code>level</code>	Exclude messages of the specified severity level.
<code><level></code>	The severity level to exclude. The level can be specified as one of the following numbers or level names, where 0 is the highest severity and 7 is the lowest severity:
	0 emergencies System is unusable
	1 alerts Action must be taken immediately
	2 critical Critical conditions
	3 errors Error conditions
	4 warnings Warning conditions

Parameter	Description
	5 notices Normal, but significant, conditions
	6 informational Informational messages
	7 debugging Debug-level messages
program	Exclude messages from a specified program.
<program-name>	The name of a program. You can enter either one of the following predefined program names (depending on your device model), or another program name that you find in the log output. The pre-defined names are not case sensitive but other program names from the log output are.
	rip Routing Information Protocol (RIP)
	ripng Routing Information Protocol - next generation (RIPng)
	ospf Open Shortest Path First (OSPF)
	ospfv3 Open Shortest Path First (OSPF) version 3 (OSPFv3)
	bgp Border Gateway Protocol (BGP)
	rsvp Resource Reservation Protocol (RSVP)
	pim-dm Protocol Independent Multicast - Dense Mode (PIM-DM)
	pim-sm Protocol Independent Multicast - Sparse Mode (PIM-SM)
	pim-smv6 PIM-SM version 6 (PIM-SMv6)
	dot1x IEEE 802.1X Port-Based Access Control
	lacp Link Aggregation Control Protocol (LACP)
	stp Spanning Tree Protocol (STP)
	rstp Rapid Spanning Tree Protocol (RSTP)
	mstp Multiple Spanning Tree Protocol (MSTP)
	imi Integrated Management Interface (IMI)
	imish Integrated Management Interface Shell (IMISH)
	epsr Ethernet Protection Switched Rings (EPSR)
	irdp ICMP Router Discovery Protocol (IRDP)
	rmon Remote Monitoring
	loopprot Loop Protection
	poep Power-inline (Power over Ethernet)
	dhcpsn DHCP snooping (DHCP SN)
facility	Exclude messages from a syslog facility.
<facility>	Specify one of the following syslog facilities to exclude messages from:
	kern Kernel messages
	user Random user-level messages
	mail Mail system

Parameter	Description
daemon	System daemons
auth	Security/authorization messages
syslog	Messages generated internally by syslogd
lpr	Line printer subsystem
news	Network news subsystem
uucp	UUCP subsystem
cron	Clock daemon
authpriv	Security/authorization messages (private)
ftp	FTP daemon
msgtext	Exclude messages containing a certain text string.
<text-string>	A text string to match (maximum 128 characters). This is case sensitive, and must be the last text on the command line.

Default No log messages are excluded

Mode Global configuration

Example To exclude messages that contain the string 'example of irrelevant message' being sent to the remote syslog server 10.10.10.100, use the following commands:

```
awplus# configure terminal
awplus(config)# log host 10.10.10.100 exclude msgtext example
of irrelevant message
```

Example (VRF-lite) To exclude messages that contain the string 'example of irrelevant message' being sent to the remote syslog server 10.10.10.100, within VRF 'red', use the following commands:

```
awplus# configure terminal
awplus(config)# log host 10.10.10.100 vrf red exclude msgtext
example of irrelevant message
```

Related commands

- [default log host](#)
- [log host](#)
- [log host \(filter\)](#)
- [log host source](#)
- [log host time](#)
- [show log config](#)

Command changes Version 5.2.2-1.1: **vrf** parameter added for products that support VRF

log host source

Overview Use this command to specify a source interface or IP address for the device to send syslog messages from. You can specify any one of an interface name, an IPv4 address or an IPv6 address.

This is useful if the device can reach the syslog server via multiple interfaces or addresses and you want to control which interface/address the device uses.

Note that AlliedWare Plus does not support source interface settings on secure log hosts (which are hosts configured using "log host <ip-address> secure").

Use the **no** variant of this command to stop specifying a source interface or address.

Syntax `log host source {<interface-name>|<ipv4-addr>|<ipv6-addr>}`
`no log host source`

Parameter	Description
<interface-name>	Specify the source interface name. You can enter a VLAN, eth interface or loopback interface.
<ipv4-addr>	Specify the source IPv4 address, in dotted decimal notation (A.B.C.D).
<ipv6-addr>	Specify the source IPv6 address, in X:X::X:X notation.

Default None (no source is configured)

Mode Global Configuration

Example To send syslog messages from 192.168.1.1, use the commands:

```
awplus# configure terminal
awplus(config)# log host source 192.168.1.1
```

Related commands

- [default log host](#)
- [log host](#)
- [log host \(filter\)](#)
- [log host exclude](#)
- [log host time](#)
- [show log config](#)

log host startup-delay

Overview Use this command to set the delay between the device booting up and it attempting to connect to remote log hosts. This is to allow time for network connectivity to the remote host to be established. During this period, the device buffers log messages and sends them once it has connected to the remote host.

The startup delay begins when the message "syslog-ng starting up" appears in the log.

If the default startup delay is not long enough for the boot and configuration process to complete and the links to come up, you may see logging failure messages on startup. In these cases, you can use the command to increase the startup delay.

Use the **no** variant of this command to return to the default delay values.

Syntax `log host startup-delay [delay <1-600>] [messages <1-5000>]`
`no log host startup-delay`

Parameter	Description
<code>delay <1-600></code>	The time, in seconds, from when syslog starts before the device attempts to filter and transmit the buffered messages to remote hosts.
<code>messages <1-5000></code>	The maximum number of messages that the device will buffer during the delay period.

Default By default the system will buffer up to 2000 messages and wait 120 seconds from when syslog starts before attempting to filter and transmit the buffered messages to remote hosts.

Mode Global Configuration

Example To increase the delay to 180 seconds, use the commands:

```
awplus# configure terminal
awplus(config)# log host startup-delay delay 180
```

Related commands

- [default log host](#)
- [log host \(filter\)](#)
- [log host exclude](#)
- [log host source](#)
- [log host time](#)
- [log trustpoint](#)
- [show log config](#)

Command changes Version 5.4.8-0.2: defaults changed

log host time

Overview This command configures the time used in messages sent to a remote syslog server. If the syslog server is in a different time zone to your device then the time offset can be configured using either the **utc-offset** parameter option keyword or the **local-offset** parameter option keyword, where **utc-offset** is the time difference from UTC (Universal Time, Coordinated) and **local-offset** is the difference from local time.

Syntax `log host {<hostname>|<ipv4-addr>|<ipv6-addr>} time {local|local-offset|utc-offset {plus|minus} <0-24>}`

Syntax (VRF-lite) `log host {<ipv4-addr>|<ipv6-addr>} [vrf <vrf-name>] time {local|local-offset|utc-offset {plus|minus} <0-24>}`

Parameter	Description
<code><hostname></code>	The host name of a remote syslog server.
<code><ipv4-addr></code>	The IPv4 address of a remote syslog server, in A.B.C.D format.
<code><ipv6-addr></code>	The IPv6 address of a remote syslog server, in X:X::X:X format.
<code><email-address></code>	The email address to send log messages to
<code>vrf <vrf-name></code>	The name of a VRF instance. Use this if the syslog server is inside a VRF. The default is the global VRF.
<code>time</code>	Specify the time difference between the email recipient and the device you are configuring.
<code>local</code>	The device is in the same time zone as the email recipient
<code>local-offset</code>	The device is in a different time zone to the email recipient. Use the plus or minus keywords and specify the difference (offset) from local time of the device to the email recipient in hours.
<code>utc-offset</code>	The device is in a different time zone to the email recipient. Use the plus or minus keywords and specify the difference (offset) from UTC time of the device to the email recipient in hours.
<code>plus</code>	Negative offset (difference) from the device to the syslog server.
<code>minus</code>	Positive offset (difference) from the device to the syslog server.
<code><0-24></code>	World Time zone offset in hours

Default The default is **local** time.

Mode Global Configuration

Usage notes Use the **local** option if the remote syslog server is in the same time zone as the device. Messages will display the time as on the local device when the message was generated.

Use the **offset** option if the email recipient is in a different time zone to this device. Specify the time offset of the remote syslog server in hours. Messages will display the time they were generated on this device but converted to the time zone of the remote syslog server.

Examples To send messages to the remote syslog server with the IP address 10.32.16.21 in the same time zone as the device's local time zone, use the following commands:

```
awplus# configure terminal
awplus(config)# log host 10.32.16.21 time local 0
```

To send messages to the remote syslog server with the IP address 10.32.16.12 with the time information converted to the time zone of the remote syslog server, which is 3 hours ahead of the device's local time zone, use the following commands:

```
awplus# configure terminal
awplus(config)# log host 10.32.16.12 time local-offset plus 3
```

To send messages to the remote syslog server with the IP address 10.32.16.02 with the time information converted to the time zone of the email recipient, which is 3 hours behind the device's UTC time zone, use the following commands:

```
awplus# configure terminal
awplus(config)# log host 10.32.16.02 time utc-offset minus 3
```

Example (VRF-lite) To send messages to the remote syslog server with the IP address 10.32.16.02 within the VRF 'red', in the same time zone as the switch's local time zone, use the following commands:

```
awplus# configure terminal
awplus(config)# log host 10.32.16.02 vrf red time utc-offset
minus 3
```

Related commands

- [default log host](#)
- [log host](#)
- [log host \(filter\)](#)
- [log host exclude](#)
- [log host source](#)
- [show log config](#)

Command changes Version 5.5.2-1.1: **vrf** parameter added for products that support VRF

log monitor (filter)

Overview This command creates a filter to select messages to be sent to the terminal when the **terminal monitor** command is given. Selection can be based on the priority/severity of the message, the program that generated the message, the logging facility used, a sub-string within the message or a combination of some or all of these.

Syntax `log monitor [level <level>] [program <program-name>] [facility <facility>] [msgtext <text-string>]`
`no log monitor [level <level>] [program <program-name>]`
`[facility <facility>] [msgtext <text-string>]`

Parameter	Description
level	Filter messages by severity level.
<level>	The minimum severity of message to send. The level can be specified as one of the following numbers or level names, where 0 is the highest severity and 7 is the lowest severity:
0 emergencies	System is unusable
1 alerts	Action must be taken immediately
2 critical	Critical conditions
3 errors	Error conditions
4 warnings	Warning conditions
5 notices	Normal, but significant, conditions
6 informational	Informational messages
7 debugging	Debug-level messages
program	Filter messages by program. Include messages from a specified program.
<program-name>	The name of a program to log messages from. You can enter either one of the following predefined program names (depending on your device model), or another program name that you find in the log output. The pre-defined names are not case sensitive but other program names from the log output are.
rip	Routing Information Protocol (RIP)
ripng	Routing Information Protocol - next generation (RIPng)
ospf	Open Shortest Path First (OSPF)
ospfv3	Open Shortest Path First (OSPF) version 3 (OSPFv3)
bgp	Border Gateway Protocol (BGP)
rsvp	Resource Reservation Protocol (RSVP)
pim-dm	Protocol Independent Multicast - Dense Mode (PIM-DM)
pim-sm	Protocol Independent Multicast - Sparse Mode (PIM-SM)
pim-smv6	PIM-SM version 6 (PIM-SMv6)

Parameter	Description
dot1x	IEEE 802.1X Port-Based Access Control
lacp	Link Aggregation Control Protocol (LACP)
stp	Spanning Tree Protocol (STP)
rstp	Rapid Spanning Tree Protocol (RSTP)
mstp	Multiple Spanning Tree Protocol (MSTP)
imi	Integrated Management Interface (IMI)
imish	Integrated Management Interface Shell (IMISH)
epsr	Ethernet Protection Switched Rings (EPSR)
irdp	ICMP Router Discovery Protocol (IRDP)
rmon	Remote Monitoring
loopprot	Loop Protection
poe	Power-inline (Power over Ethernet)
dhcpcsn	DHCP snooping (DHCPSN)
facility	Filter messages by syslog facility.
<facility>	Specify one of the following syslog facilities to include messages from:
kern	Kernel messages
user	Random user-level messages
mail	Mail system
daemon	System daemons
auth	Security/authorization messages
syslog	Messages generated internally by syslogd
lpr	Line printer subsystem
news	Network news subsystem
uucp	UUCP subsystem
cron	Clock daemon
authpriv	Security/authorization messages (private)
ftp	FTP daemon
msgtext	Select messages containing a certain text string.
<text-string>	A text string to match (maximum 128 characters). This is case sensitive, and must be the last text on the command line.

Default By default there is a filter to select all messages. This filter may be removed and replaced by filters that are more selective.

Mode Global Configuration

Examples To create a filter to send all messages that are generated by authentication and have a severity of **info** or higher to terminal instances where the terminal monitor command has been given, use the following commands:

```
awplus# configure terminal
awplus(config)# log monitor level info program auth
```

To remove a default filter that includes sending everything to the terminal, use the following commands:

```
awplus# configure terminal
awplus(config)# no log monitor level debugging
```

Related commands

- [default log monitor](#)
- [log monitor exclude](#)
- [show log config](#)
- [terminal monitor](#)

log monitor exclude

Overview Use this command to prevent specified log messages from being displayed on a terminal, when **terminal monitor** is enabled. You can exclude messages on the basis of:

- the priority/severity of the message
- the program that generated the message
- the logging facility used
- a sub-string within the message, or
- a combination of some or all of these.

Use the **no** variant of this command to stop excluding the specified messages.

Syntax `log console exclude [level <level>] [program <program-name>]
[facility <facility>] [msgtext <text-string>]`
`no log console exclude [level <level>] [program <program-name>]
[facility <facility>] [msgtext <text-string>]`

Parameter	Description
level	Exclude messages of the specified severity level.
<level>	The severity level to exclude. The level can be specified as one of the following numbers or level names, where 0 is the highest severity and 7 is the lowest severity:
0 emergencies	System is unusable
1 alerts	Action must be taken immediately
2 critical	Critical conditions
3 errors	Error conditions
4 warnings	Warning conditions
5 notices	Normal, but significant, conditions
6 informational	Informational messages
7 debugging	Debug-level messages
program	Exclude messages from a specified program.
<program-name>	The name of a program. You can enter either one of the following predefined program names (depending on your device model), or another program name that you find in the log output. The pre-defined names are not case sensitive but other program names from the log output are.
rip	Routing Information Protocol (RIP)
ripng	Routing Information Protocol - next generation (RIPng)
ospf	Open Shortest Path First (OSPF)
ospfv3	Open Shortest Path First (OSPF) version 3 (OSPFv3)

Parameter	Description
bgp	Border Gateway Protocol (BGP)
rsvp	Resource Reservation Protocol (RSVP)
pim-dm	Protocol Independent Multicast - Dense Mode (PIM-DM)
pim-sm	Protocol Independent Multicast - Sparse Mode (PIM-SM)
pim-smv6	PIM-SM version 6 (PIM-SMv6)
dot1x	IEEE 802.1X Port-Based Access Control
lacp	Link Aggregation Control Protocol (LACP)
stp	Spanning Tree Protocol (STP)
rstp	Rapid Spanning Tree Protocol (RSTP)
mstp	Multiple Spanning Tree Protocol (MSTP)
imi	Integrated Management Interface (IMI)
imish	Integrated Management Interface Shell (IMISH)
epsr	Ethernet Protection Switched Rings (EPSR)
irdp	ICMP Router Discovery Protocol (IRDP)
rmon	Remote Monitoring
loopprot	Loop Protection
poe	Power-inline (Power over Ethernet)
dhcpsn	DHCP snooping (DHCP SN)
facility	Exclude messages from a syslog facility.
<facility>	Specify one of the following syslog facilities to exclude messages from:
kern	Kernel messages
user	Random user-level messages
mail	Mail system
daemon	System daemons
auth	Security/authorization messages
syslog	Messages generated internally by syslogd
lpr	Line printer subsystem
news	Network news subsystem
uucp	UUCP subsystem
cron	Clock daemon
authpriv	Security/authorization messages (private)
ftp	FTP daemon

Parameter	Description
msgtext	Exclude messages containing a certain text string.
<text-string>	A text string to match (maximum 128 characters). This is case sensitive, and must be the last text on the command line.

Default No log messages are excluded

Mode Global configuration

Example To remove messages that contain the string “example of irrelevant message”, use the following commands:

```
awplus# configure terminal
awplus(config)# log monitor exclude msgtext example of
irrelevant message
```

Related commands

- default log monitor
- log monitor (filter)
- show log config
- terminal monitor

log permanent

Overview This command configures the device to send permanent log messages to non-volatile storage (NVS) on the device. The content of the permanent log is retained over a reboot. Once the permanent log reaches its configured maximum allowable size old messages will be deleted to make way for new messages.

The **no** variant of this command configures the device not to send any messages to the permanent log. Log messages will not be retained over a restart.

Syntax `log permanent`
`no log permanent`

Mode Global Configuration

Examples To enable permanent logging use the following commands:

```
awplus# configure terminal
awplus(config)# log permanent
```

To disable permanent logging use the following commands:

```
awplus# configure terminal
awplus(config)# no log permanent
```

Related commands

- `clear log permanent`
- `copy permanent-log`
- `default log permanent`
- `log permanent (filter)`
- `log permanent exclude`
- `log permanent size`
- `show log config`
- `show log permanent`

log permanent (filter)

Overview This command creates a filter to select messages to be sent to the permanent log. Selection can be based on the priority/ severity of the message, the program that generated the message, the logging facility used, a sub-string within the message or a combination of some or all of these.

The **no** variant of this command removes the corresponding filter, so that the specified messages are no longer sent to the permanent log.

Syntax `log permanent [level <level>] [program <program-name>]
[facility <facility>] [msgtext <text-string>]`
`no log permanent [level <level>] [program <program-name>]
[facility <facility>] [msgtext <text-string>]`

Parameter	Description
level	Filter messages sent to the permanent log by severity level.
<level>	The minimum severity of message to send. The level can be specified as one of the following numbers or level names, where 0 is the highest severity and 7 is the lowest severity:
0 emergencies	System is unusable
1 alerts	Action must be taken immediately
2 critical	Critical conditions
3 errors	Error conditions
4 warnings	Warning conditions
5 notices	Normal, but significant, conditions
6 informational	Informational messages
7 debugging	Debug-level messages
program	Filter messages by program. Include messages from a specified program.
<program-name>	The name of a program to log messages from. You can enter either one of the following predefined program names (depending on your device model), or another program name that you find in the log output. The pre-defined names are not case sensitive but other program names from the log output are.
rip	Routing Information Protocol (RIP)
ripng	Routing Information Protocol - next generation (RIPng)
ospf	Open Shortest Path First (OSPF)
ospfv3	Open Shortest Path First (OSPF) version 3 (OSPFv3)
bgp	Border Gateway Protocol (BGP)
rsvp	Resource Reservation Protocol (RSVP)
pim-dm	Protocol Independent Multicast - Dense Mode (PIM-DM)
pim-sm	Protocol Independent Multicast - Sparse Mode (PIM-SM)

Parameter	Description
pim-smv6	PIM-SM version 6 (PIM-SMv6)
dot1x	IEEE 802.1X Port-Based Access Control
lacp	Link Aggregation Control Protocol (LACP)
stp	Spanning Tree Protocol (STP)
rstp	Rapid Spanning Tree Protocol (RSTP)
mstp	Multiple Spanning Tree Protocol (MSTP)
imi	Integrated Management Interface (IMI)
imish	Integrated Management Interface Shell (IMISH)
epsr	Ethernet Protection Switched Rings (EPSR)
irdp	ICMP Router Discovery Protocol (IRDP)
rmon	Remote Monitoring
loopprot	Loop Protection
poe	Power-inline (Power over Ethernet)
dhcpsn	DHCP snooping (DHPCPSN)
facility	Filter messages by syslog facility.
<facility>	Specify one of the following syslog facilities to include messages from:
kern	Kernel messages
user	Random user-level messages
mail	Mail system
daemon	System daemons
auth	Security/authorization messages
syslog	Messages generated internally by syslogd
lpr	Line printer subsystem
news	Network news subsystem
uucp	UUCP subsystem
cron	Clock daemon
authpriv	Security/authorization messages (private)
ftp	FTP daemon
msgtext	Select messages containing a certain text string.
<text-string>	A text string to match (maximum 128 characters). This is case sensitive, and must be the last text on the command line.

Default By default the buffered log has a filter to select messages whose severity level is `notices` (5) or higher. This filter may be removed using the **no** variant of this command.

Mode Global Configuration

Examples To create a filter to send all messages containing the text “Bridging initialization”, to the permanent log use the following commands:

```
awplus# configure terminal
awplus(config)# log permanent msgtext Bridging initialization
```

Related commands

- clear log permanent
- default log permanent
- log permanent
- log permanent exclude
- log permanent size
- show log config
- show log permanent

log permanent exclude

Overview Use this command to prevent specified log messages from being sent to the permanent log. You can exclude messages on the basis of:

- the priority/severity of the message
- the program that generated the message
- the logging facility used
- a sub-string within the message, or
- a combination of some or all of these.

Use the **no** variant of this command to stop excluding the specified messages.

Syntax `log permanent exclude [level <level>] [program <program-name>] [facility <facility>] [msgtext <text-string>]`
`no log permanent exclude [level <level>] [program <program-name>] [facility <facility>] [msgtext <text-string>]`

Parameter	Description
level	Exclude messages of the specified severity level.
<level>	The severity level to exclude. The level can be specified as one of the following numbers or level names, where 0 is the highest severity and 7 is the lowest severity:
0 emergencies	System is unusable
1 alerts	Action must be taken immediately
2 critical	Critical conditions
3 errors	Error conditions
4 warnings	Warning conditions
5 notices	Normal, but significant, conditions
6 informational	Informational messages
7 debugging	Debug-level messages
program	Exclude messages from a specified program.
<program-name>	The name of a program. You can enter either one of the following predefined program names (depending on your device model), or another program name that you find in the log output. The pre-defined names are not case sensitive but other program names from the log output are.
rip	Routing Information Protocol (RIP)
ripng	Routing Information Protocol - next generation (RIPng)
ospf	Open Shortest Path First (OSPF)
ospfv3	Open Shortest Path First (OSPF) version 3 (OSPFv3)
bgp	Border Gateway Protocol (BGP)

Parameter	Description
rsvp	Resource Reservation Protocol (RSVP)
pim-dm	Protocol Independent Multicast - Dense Mode (PIM-DM)
pim-sm	Protocol Independent Multicast - Sparse Mode (PIM-SM)
pim-smv6	PIM-SM version 6 (PIM-SMv6)
dot1x	IEEE 802.1X Port-Based Access Control
lacp	Link Aggregation Control Protocol (LACP)
stp	Spanning Tree Protocol (STP)
rstp	Rapid Spanning Tree Protocol (RSTP)
mstp	Multiple Spanning Tree Protocol (MSTP)
imi	Integrated Management Interface (IMI)
imish	Integrated Management Interface Shell (IMISH)
epsr	Ethernet Protection Switched Rings (EPSR)
irdp	ICMP Router Discovery Protocol (IRDP)
rmon	Remote Monitoring
loopprot	Loop Protection
poe	Power-inline (Power over Ethernet)
dhcpsn	DHCP snooping (DHPCPSN)
facility	Exclude messages from a syslog facility.
<facility>	Specify one of the following syslog facilities to exclude messages from:
kern	Kernel messages
user	Random user-level messages
mail	Mail system
daemon	System daemons
auth	Security/authorization messages
syslog	Messages generated internally by syslogd
lpr	Line printer subsystem
news	Network news subsystem
uucp	UUCP subsystem
cron	Clock daemon
authpriv	Security/authorization messages (private)
ftp	FTP daemon
msgtext	Exclude messages containing a certain text string.
<text-string>	A text string to match (maximum 128 characters). This is case sensitive, and must be the last text on the command line.

Default No log messages are excluded

Mode Global configuration

Example To remove messages that contain the string “example of irrelevant message”, use the following commands:

```
awplus# configure terminal
awplus(config)# log permanent exclude msgtext example of
irrelevant message
```

Related commands

- clear log permanent
- default log permanent
- log permanent
- log permanent (filter)
- log permanent size
- show log config
- show log permanent

log permanent size

Overview This command configures the amount of memory that the permanent log is permitted to use. Once this memory allocation has been filled old messages will be deleted to make room for new messages.

Use the **no** variant of this command to return to the default.

Syntax `log permanent size <50-250>`
`no log permanent size`

Parameter	Description
<50-250>	Size of the permanent log in kilobytes

Default 50 kilobytes

Mode Global Configuration

Example To allow the permanent log to use up to 100 kilobytes of NVS, use the commands:

```
awplus# configure terminal
awplus(config)# log permanent size 100
```

To return to the default value, use the commands:

```
awplus# configure terminal
awplus(config)# no log permanent size
```

Related commands

- [clear log permanent](#)
- [copy permanent-log](#)
- [default log permanent](#)
- [log permanent](#)
- [log permanent \(filter\)](#)
- [log permanent exclude](#)
- [show log config](#)
- [show log permanent](#)

log-rate-limit nsm

Overview This command limits the number of log messages generated by the device for a specified time interval.

Use the **no** variant of this command to revert to the default number of log messages, which is up to 200 log messages per second.

Syntax `log-rate-limit nsm messages <message-limit> interval <time-interval>`
`no log-rate-limit nsm`

Parameter	Description
<code><message-limit></code>	<code><1-65535></code> The number of log messages generated by the device.
<code><time-interval></code>	<code><0-65535></code> The time period for log message generation in 1/100 seconds. If an interval of 0 is specified then no log message rate limiting is applied.

Default By default, the device will allow 200 log messages to be generated per second.

Mode Global Configuration

Usage notes This command limits the rate that log messages are generated. Limiting log messages protects the device from running out of memory in extreme conditions, such as during a broadcast storm.

Once the specified number of log messages per interval is exceeded, any excess log messages are dropped. When this occurs a summary log message is generated at the end of the interval. This summary message includes the number of log messages dropped.

If you expect a lot of dropped log messages, we recommend setting the time interval to no less than 100. This limits the number of summary messages to one per second, which prevents the log from filling up with these summary messages.

Examples To allow the device to generate a maximum of 300 log messages per second, use the following commands:

```
awplus# configure terminal
awplus(config)# log-rate-limit nsm messages 300 interval 100
```

To return the device to the default setting, use the following commands:

```
awplus# configure terminal
awplus(config)# no log-rate-limit nsm
```

log trustpoint

Overview This command adds one or more trustpoints to be used with the syslog application. Multiple trustpoints may be specified, or the command may be executed multiple times, to add multiple trustpoints to the application.

The **no** version of this command removes one or more trustpoints from the list of trustpoints associated with the application.

Syntax `log trustpoint [<trustpoint-list>]`
`no log trustpoint [<trustpoint-list>]`

Parameter	Description
<code><trustpoint-list></code>	Specify one or more trustpoints to be added or deleted.

Default No trustpoints are created by default.

Mode Global Configuration

Usage notes The device certificate associated with first trustpoint added to the application will be transmitted to remote servers. The certificate received from the remote server must have an issuer chain that terminates with the root CA certificate for any of the trustpoints that are associated with the application.

If no trustpoints are specified in the command, the trustpoint list will be unchanged.

If **no log trustpoint** is issued without specifying any trustpoints, then all trustpoints will be disassociated from the application.

Example You can add multiple trustpoints by executing the command multiple times:

```
awplus# configure terminal
awplus(config)# log trustpoint trustpoint_1
awplus(config)# log trustpoint trustpoint_2
```

Alternatively, add multiple trustpoints with a single command:

```
awplus(config)# log trustpoint trustpoint_2 trustpoint_3
```

Disassociate all trustpoints from the syslog application using the command:

```
awplus(config)# no log trustpoint trustpoint_2 trustpoint_3
```

Related commands [log host](#)
[show log config](#)

log url-requests

Overview If URL Filtering is enabled, then by default, black list hits and issues with match criteria and list files are logged.

Use this command to enable logging of all HTTP and HTTPS URL requests (both permitted and denied) passing through the firewall.

Use the **no** variant of this command to disable extra logging of HTTP and HTTPS URL requests passing through the firewall.

Syntax `log url-requests`
`no log url-requests`

Default Disabled by default.

Mode URL Filter Configuration

Usage notes When enabled, additional log messages for HTTP and HTTPS URL requests passing through the firewall contain the:

- URL being accessed
- IP address of the user that requested the URL

Example To configure logging of all HTTP and HTTPS URL requests passing through the firewall (permitted as well as denied), use the following commands:

```
awplus# configure terminal
awplus(config)# url-filter
awplus(config-url-filter)# log url-requests
```

Related commands [url-filter](#)

Command changes Version 5.4.7-1.1: command added

show connection-log events

Overview This command displays the configuration state (enabled or disabled) for the logging of connections passing through the firewall, as configured by the [connection-log events](#) command.

Syntax `show connection-log events`

Mode User Exec

Example To show the logging configuration state for the connections passing through the firewall, use the command:

```
awplus# show connection-log events
```

Output Figure 8-1: Example output from **show connection-log events**

```
awplus#show connection-log events
Log new connection events:      Disabled
Log connection end events:     Enabled
```

Related commands [connection-log events](#)

Command changes Version 5.4.7-1.1: command added.

show counter log

Overview This command displays log counter information.

Syntax show counter log

Mode User Exec and Privileged Exec

Example To display the log counter information, use the command:

```
awplus# show counter log
```

Output Figure 8-2: Example output from the **show counter log** command

```
Log counters
Total Received      ..... 2328
Total Received P0   ..... 0
Total Received P1   ..... 0
Total Received P2   ..... 1
Total Received P3   ..... 9
Total Received P4   ..... 32
Total Received P5   ..... 312
Total Received P6   ..... 1602
Total Received P7   ..... 372
```

Table 9: Parameters in output of the **show counter log** command

Parameter	Description
Total Received	Total number of messages received by the log
Total Received P0	Total number of Priority 0 (Emergency) messages received
Total Received P1	Total number of Priority 1 (Alert) messages received
Total Received P2	Total number of Priority 2 (Critical) messages received
Total Received P3	Total number of Priority 3 (Error) messages received
Total Received P4	Total number of Priority 4 (Warning) messages received
Total Received P5	Total number of Priority 5 (Notice) messages received
Total Received P6	Total number of Priority 6 (Info) messages received
Total Received P7	Total number of Priority 7 (Debug) messages received

Related commands [show log config](#)

show exception log

Overview This command displays the contents of the exception log. If the device has unexpectedly restarted and has produced a core dump file, the output of this command shows the name and location of the file.

Syntax `show exception log`

Mode User Exec and Privileged Exec

Example To display the exception log, use the command:

```
awplus# show exception log
```

Output Figure 8-3: Example output from the **show exception log** command on a device that has never had an exception occur

```
awplus#show exception log
<date> <time> <facility>.<severity> <program[<pid>]: <message>
-----
None
-----
awplus#
```

show log

Overview This command displays the contents of the buffered log.
For information on filtering and saving command output, see the [“Getting Started with AlliedWare_Plus” Feature Overview and Configuration Guide](#).

Syntax `show log [tail [<10-250>]]`

Parameter	Description
tail	Display only the latest log entries.
<10-250>	Specify the number of log entries to display.

Default By default the entire contents of the buffered log is displayed.

Mode User Exec, Privileged Exec and Global Configuration

Usage notes If the optional **tail** parameter is specified, only the latest 10 messages in the buffered log are displayed. A numerical value can be specified after the **tail** parameter to select how many of the latest messages should be displayed.

The **show log** command is only available to users at privilege level 7 and above. To set a user’s privilege level, use the command:

```
awplus(config)# username <name> privilege <1-15>
```

Examples To display the contents of the buffered log use the command:

```
awplus# show log
```

To display the 10 latest entries in the buffered log use the command:

```
awplus# show log tail 10
```

Output Figure 8-4: Example output from **show log**

```
awplus#show log

<date> <time> <facility>.<severity> <program[<pid>]: <message>
-----
2019 May 29 07:55:22 kern.warning awplus kernel: No pci config register base in
dev tree, using default
2019 May 29 07:55:23 kern.notice awplus kernel: Kernel command line: console=tty
S0,9600 releasefile= ramdisk=14688 bootversion=1.1.0-rc12 loglevel=1
extraflash=00000000
2019 May 29 07:55:25 kern.notice awplus kernel: RAMDISK: squashfs filesystem fou
nd at block 0
2019 May 29 07:55:28 kern.warning awplus kernel: ipifwd: module license 'Proprie
tary' taints kernel.
...
```

**Related
commands**

clear log buffered
copy buffered-log
default log buffered
log buffered
log buffered (filter)
log buffered size
log buffered exclude
show log config

show log config

Overview This command displays information about the logging system. This includes the configuration of the various log destinations, such as buffered, permanent, syslog servers (hosts) and email addresses. This also displays the latest status information for each log destination.

Syntax `show log config`

Mode User Exec, Privileged Exec and Global Configuration

Example To display the logging configuration use the command:

```
awplus# show log config
```

Output Figure 8-5: Example output from **show log config**

```
Facility: default
PKI trustpoints: example_trustpoint

Buffered log:
Status ..... enabled
Maximum size ... 100kb
Filters:
*1 Level ..... notices
  Program ..... any
  Facility ..... any
  Message text . any
  2 Level ..... informational
  Program ..... auth
  Facility ..... daemon
  Message text . any
  Statistics .... 1327 messages received, 821 accepted by filter (2016 Oct 11
10:36:16)
Permanent log:
Status ..... enabled
Maximum size ... 60kb
Filters:
 1 Level ..... error
  Program ..... any
  Facility ..... any
  Message text . any
*2 Level ..... warnings
  Program ..... dhcp
  Facility ..... any
  Message text . "pool exhausted"
  Statistics .... 1327 messages received, 12 accepted by filter (2016 Oct 11
10:36:16)
```

```
Host 10.32.16.21:
  Time offset .... +2:00
  Offset type .... UTC
  Source ..... -
  Secured ..... enabled
  Filters:
  1 Level ..... critical
    Program ..... any
    Facility ..... any
    Message text . any
  Statistics ..... 1327 messages received, 1 accepted by filter (2016 Oct 11
10:36:16)
Email admin@alliedtelesis.com:
  Time offset .... +0:00
  Offset type .... Local
  Filters:
  1 Level ..... emergencies
    Program ..... any
    Facility ..... any
    Message text . any
  Statistics ..... 1327 messages received, 0 accepted by filter (2016 Oct 11
10:36:16)
...
```

In the above example the '*' next to filter 1 in the buffered log configuration indicates that this is the default filter. The permanent log has had its default filter removed, so none of the filters are marked with '*'.

NOTE: Terminal log and console log cannot be set at the same time. If console logging is enabled then the terminal logging is turned off.

Related commands

- [show counter log](#)
- [show log](#)
- [show log permanent](#)

show log external

Overview Use this command to display the contents of the external log, which is stored on a USB storage device.

Syntax `show log external [tail [<10-250>]]`

Parameter	Description
tail	Display only the latest log entries.
<10-250>	Specify the number of log entries to display.

Mode Global Configuration

Privileged Exec

User Exec

Usage notes If the optional **tail** parameter is specified, only the latest 10 messages in the permanent log are displayed. A numerical value can be specified after the **tail** parameter to change how many of the latest messages should be displayed.

Example To display the last 5 entries in the external log, use the command:

```
awplus# show log external tail 5
```

Related commands

- [clear log external](#)
- [default log external](#)
- [log external](#)
- [log external \(filter\)](#)
- [log external exclude](#)
- [log external rotate](#)
- [log external size](#)
- [show log config](#)
- [unmount](#)

Command changes Version 5.4.7-1.1: command added

show log permanent

Overview This command displays the contents of the permanent log.

Syntax show log permanent [tail [<10-250>]]

Parameter	Description
tail	Display only the latest log entries.
<10-250>	Specify the number of log entries to display.

Usage notes If the optional **tail** parameter is specified, only the latest 10 messages in the permanent log are displayed. A numerical value can be specified after the **tail** parameter to change how many of the latest messages should be displayed.

Mode User Exec, Privileged Exec and Global Configuration

Example To display the permanent log, use the command:

```
awplus# show log permanent
```

Output Figure 8-6: Example output from **show log permanent**

```
awplus#show log permanent
<date> <time> <facility>.<severity> <program[<pid>]>: <message>
-----
2014 Jun 10 09:30:09 syslog.notice syslog-ng[67]: syslog-ng starting up;
version='\`2.0rc3\`'
2014 Jun 10 09:30:09 auth.warning portmap[106]: user rpc not found, reverting to
user bin
2014 Jun 10 09:30:09 cron.notice crond[116]: crond 2.3.2 dillon, started, log
level 8
2014 Jun 10 09:30:14 daemon.err snmpd[181]: /flash/.configs/snmpd.conf: line 20:
Error: bad SUBTREE object
2014 Jun 10 09:30:14 user.info HSL[192]: HSL: INFO: Registering port port1.0.1
```

- Related commands**
- [clear log permanent](#)
 - [copy permanent-log](#)
 - [default log permanent](#)
 - [log permanent](#)
 - [log permanent \(filter\)](#)
 - [log permanent exclude](#)
 - [log permanent size](#)
 - [show log config](#)

show running-config log

Overview This command displays the current running configuration of the Log utility.

Syntax `show running-config log`

Mode Privileged Exec and Global Configuration

Example To display the current configuration of the log utility, use the command:

```
awplus# show running-config log
```

Related commands [show log](#)
[show log config](#)

unmount

Overview Use this command to unmount an external storage device. We recommend you unmount storage devices before removing them, to avoid file corruption. This is especially important if files may be automatically written to the storage device, such as external log files or AMF backup files.

Syntax `unmount usb`

Parameter	Description
usb	Unmount the USB storage device.

Mode Privileged Exec

Example To unmount a USB storage device and safely remove it from the device, use the command:

```
awplus# unmount usb
```

Related commands

- [clear log external](#)
- [log external](#)
- [show file systems](#)
- [show log config](#)
- [show log external](#)

Command changes Version 5.4.7-1.1: command added

9

Scripting Commands

Introduction

Overview This chapter provides commands used for command scripts.

- Command List**
- “[activate](#)” on page 438
 - “[echo](#)” on page 439
 - “[wait](#)” on page 440

activate

Overview This command activates a script file.

Syntax activate [background] <script>

Parameter	Description
background	Activate a script to run in the background. A process that is running in the background will operate as a separate task, and will not interrupt foreground processing. Generally, we recommend running short, interactive scripts in the foreground and longer scripts in the background. The default is to run the script in the foreground.
<script>	The file name of the script to activate. The script is a command script consisting of commands documented in this software reference. Note that you must use either a .scp or a .sh filename extension for a valid script text file, as described below in the usage section for this command.

Mode Privileged Exec

Usage notes When a script is activated, the privilege level is set to 1 enabling User Exec commands to run in the script. If you need to run Privileged Exec commands in your script you need to add an [enable \(Privileged Exec mode\)](#) command to the start of your script. If you need to run Global Configuration commands in your script you need to add a [configure terminal](#) command after the **enable** command at the start of your script.

The **activate** command executes the script in a new shell. A [terminal length](#) shell command, such as **terminal length 0** may also be required to disable a delay that would pause the display.

A script must be a text file with a filename extension of either **.sh** or **.scp** only for the AlliedWare Plus™ CLI to activate the script file. The **.sh** filename extension indicates the file is an ASH script, and the **.scp** filename extension indicates the file is an AlliedWare Plus™ script.

Examples To activate a command script to run as a background process, use the command:

```
awplus# activate background test.scp
```

Related commands

- [configure terminal](#)
- [echo](#)
- [enable \(Privileged Exec mode\)](#)
- [wait](#)

echo

Overview This command echoes a string to the terminal, followed by a blank line.

Syntax `echo <line>`

Parameter	Description
<code><line></code>	The string to echo

Mode User Exec and Privileged Exec

Usage This command may be useful in CLI scripts, to make the script print user-visible comments.

Example To echo the string `Hello World` to the console, use the command:

```
awplus# echo Hello World
```

Output

```
Hello World
```

Related commands [activate](#)
[wait](#)

wait

Overview This command pauses execution of the active script for the specified period of time.

Syntax `wait <delay>`

Parameter	Description
<code><delay></code>	<code><1-65535></code> Specify the time delay in seconds

Default No wait delay is specified by default.

Mode Privileged Exec (when executed from a script not directly from the command line)

Usage notes Use this command to pause script execution in an **.scp** (AlliedWare Plus™ script) or an **.sh** (ASH script) file executed by the [activate](#) command. The script must contain an **enable** command, because the **wait** command is only executed in the Privileged Exec mode.

Example See an **.scp** script file extract below that will show port counters for interface port1.0.2 over a 10 second interval:

```
enable

show interface port1.0.2

wait 10

show interface port1.0.2
```

Related commands

- [activate](#)
- [echo](#)
- [enable \(Privileged Exec mode\)](#)

10

Interface Commands

Introduction

Overview This chapter provides an alphabetical reference of commands used to configure and display interfaces.

- Command List**
- “[description \(interface\)](#)” on page 442
 - “[interface \(to configure\)](#)” on page 443
 - “[ip tcp adjust-mss](#)” on page 445
 - “[ipv6 tcp adjust-mss](#)” on page 447
 - “[mru jumbo](#)” on page 449
 - “[mtu](#)” on page 450
 - “[service statistics interfaces counter](#)” on page 452
 - “[show interface](#)” on page 453
 - “[show interface brief](#)” on page 457
 - “[show interface memory](#)” on page 458
 - “[show interface status](#)” on page 460
 - “[shutdown](#)” on page 462

description (interface)

Overview Use this command to add a description to a specific port or interface.

Syntax `description <description>`

Parameter	Description
<code><description></code>	Text describing the specific interface. Descriptions can contain any printable ASCII characters (ASCII 32-126).

Mode Interface Configuration

Example The following example uses this command to describe the device that an interface is connected to.

```
awplus# configure terminal
awplus(config)# interface port1.0.2
awplus(config-if)# description Boardroom PC
```

Command changes Version 5.4.7-1.1: valid character set changed to printable ASCII characters

interface (to configure)

Overview Use this command to select one or more interfaces to configure.

Syntax `interface <interface-list>`

Parameter	Description
<code><interface-list></code>	<p>The interfaces to configure. An interface-list can be:</p> <ul style="list-style-type: none">• a PPP interface (e.g. ppp0)• an Eth interface (e.g. eth1)• an 802.1Q Ethernet sub-interface (e.g. eth1.10, where '10' is the VLAN ID specified by the encapsulation dot1q command)• a VLAN (e.g. vlan2)• a switchport (e.g. port1.0.4)• a static channel group (e.g. sa2)• a dynamic (LACP) channel group (e.g. po2)• a bridge interface (e.g. br0)• a tunnel interface (e.g. tunnel0)• a 3G cellular interface (e.g. cellular0)• a WWAN interface (e.g. wwan0)• the loopback interface (lo)• a continuous range of interfaces, separated by a hyphen (e.g. ppp2-4)• a comma-separated list (e.g. ppp0,ppp2-4). Do not mix interface types in a list. <p>The specified interfaces must exist.</p>

Usage notes A local loopback interface is one that is always available for higher layer protocols to use and advertise to the network. Although a local loopback interface is assigned an IP address, it does not have the usual requirement of connecting to a lower layer physical entity. This lack of physical attachment creates the perception of a local loopback interface always being accessible via the network.

Local loopback interfaces can be utilized by a number of protocols for various purposes. They can be used to improve access to the device and also increase its reliability, security, scalability and protection. In addition, local loopback interfaces can add flexibility and simplify management, information gathering and filtering.

One example of this increased reliability is for OSPF to advertise a local loopback interface as an interface-route into the network irrespective of the physical links that may be 'up' or 'down' at the time. This provides a higher probability that the routing traffic will be received and subsequently forwarded.

Mode Global Configuration

Examples The following example shows how to enter Interface mode to configure VLAN interface vlan1. Note how the prompt changes.

```
awplus# configure terminal
awplus(config)# interface vlan1
awplus(config-if)#
```

The following example shows how to enter Interface mode to configure the PPP interface ppp0.

```
awplus# configure terminal
awplus(config)# interface ppp0
awplus(config-if)#
```

The following example shows how to enter Interface mode to configure the local loopback interface.

```
awplus# configure terminal
awplus(config)# interface lo
awplus(config-if)#
```

The following example shows how to enter Interface mode to configure bridge br2.

```
awplus# configure terminal
awplus(config)# interface br2
awplus(config-if)#
```

Related commands

- [ip address \(IP Addressing and Protocol\)](#)
- [show interface](#)
- [show interface brief](#)

ip tcp adjust-mss

Overview Use this command to set the Maximum Segment Size (MSS) size for an interface, where MSS is the maximum TCP data packet size that the interface can transmit before fragmentation.

Use the **no** variant of this command to remove a previously specified MSS size for a PPP interface, and restore the default MSS size.

Syntax `ip tcp adjust-mss {<mss-size>|pmtu}`
`no ip tcp adjust-mss`

Parameter	Description
<mss-size>	<64-1460> Specifies the MSS size in bytes.
pmtu	Adjust TCP MSS automatically with respect to the MTU on the interface.

Default The default setting allows a TCP server or a TCP client to set the MSS value for itself.

Mode Interface Configuration

Usage notes When a host initiates a TCP session with a server it negotiates the IP segment size by using the MSS option field in the TCP packet. The value of the MSS option field is determined by the Maximum Transmission Unit (MTU) configuration on the host.

You can set a feasible MSS value on the following interfaces:

- PPP
- Ethernet
- Tunnel
- VLAN

Examples To configure an MSS size of 1452 bytes on PPP interface ppp0, use the commands:

```
awplus# configure terminal
awplus(config)# interface ppp0
awplus(config-if)# ip tcp adjust-mss 1452
```

To configure an MSS size of 1452 bytes on Ethernet interface eth1, use the commands:

```
awplus# configure terminal
awplus(config)# interface eth1
awplus(config-if)# ip tcp adjust-mss 1452
```

To configure an MSS size of 1452 bytes on interface tunnel2, use the commands:

```
awplus# configure terminal
awplus(config)# interface tunnel2
awplus(config-if)# ip tcp adjust-mss 1452
```

To restore the MSS size to the default size on PPP interface ppp0, use the commands:

```
awplus# configure terminal
awplus(config)# interface ppp0
awplus(config-if)# no ip tcp adjust-mss
```

**Related
commands**

[mtu \(PPP\)](#)
[show interface](#)
[show interface \(PPP\)](#)
[show interface tunnel \(GRE\)](#)

**Command
changes**

Version 5.4.8-2.1: interface tunnel example added

ipv6 tcp adjust-mss

Overview Use this command to set the IPv6 Maximum Segment Size (MSS) size for an interface, where MSS is the maximum TCP data packet size that the interface can transmit before fragmentation.

Use the **no** variant of this command to remove a previously specified MSS size for a PPP interface, and restore the default MSS size.

Syntax `ipv6 tcp adjust-mss {<mss-size>|pmtu}`
`no ipv6 tcp adjust-mss`

Parameter	Description
<code><mss-size></code>	<code><64-1460></code> Specifies the MSS size in bytes.
<code>pmtu</code>	Adjust TCP MSS automatically with respect to the MTU on the interface.

Default The default setting allows a TCP server or a TCP client to set the MSS value for itself.

Mode Interface Configuration

Usage notes When a host initiates a TCP session with a server it negotiates the IP segment size by using the MSS option field in the TCP packet. The value of the MSS option field is determined by the Maximum Transmission Unit (MTU) configuration on the host.

You can set a feasible MSS value on the following interfaces:

- PPP
- Ethernet
- Tunnel
- VLAN

Examples To configure an IPv6 MSS size of 1452 bytes on PPP interface ppp0, use the commands:

```
awplus# configure terminal
awplus(config)# interface ppp0
awplus(config-if)# ipv6 tcp adjust-mss 1452
```

To configure an IPv6 MSS size of 1452 bytes on Ethernet interface eth1, use the commands:

```
awplus# configure terminal
awplus(config)# interface eth1
awplus(config-if)# ipv6 tcp adjust-mss 1452
```

To adjust IPv6 TCP MSS automatically with respect to the MTU on interface tunnel2, use the commands:

```
awplus# configure terminal
awplus(config)# interface tunnel2
awplus(config-if)# ipv6 tcp adjust-mss pmtu
```

To restore the MSS size to the default size on PPP interface ppp0, use the commands:

```
awplus# configure terminal
awplus(config)# interface ppp0
awplus(config-if)# no ipv6 tcp adjust-mss
```

**Related
commands**

[mtu \(PPP\)](#)
[show interface](#)
[show interface \(PPP\)](#)
[show interface tunnel \(GRE\)](#)

**Command
changes**

Version 5.4.8-2.1: interface tunnel example added

mru jumbo

Overview Use this command to enable the device to forward jumbo frames. For more information, see the [Switching Feature Overview and Configuration Guide](#).

When jumbo frame support is enabled, the maximum size of packets that the device can forward is 9688 bytes of payload.

Use the **no** variant of this command to remove jumbo frame support, and restore the default MRU size (1500 bytes) for switch ports.

NOTE: The number above specifies the payload only. For an IEEE 802.1q frame, provision is made (internally) for the following additional components:

- Source and Destination addresses
- EtherType field
- Priority and VLAN tag fields
- FCS

These additional components increase the frame size (to 1522 bytes in the default case).

Syntax mru jumbo
no mru

Default By default, jumbo frame support is not enabled.

Mode Interface Configuration for switch ports.

Usage notes Note that [show interface](#) output will only show MRU size for switch ports.

We recommend limiting the number of ports with jumbo frames support enabled to two.

Examples To enable the device to forward jumbo frames on port1.0.2, use the commands:

```
awplus# configure terminal
awplus(config)# interface port1.0.2
awplus(config-if)# mru jumbo
```

To remove the jumbo frame support, and therefore restore the MRU size of 1500 bytes on port1.0.2, use the commands:

```
awplus# configure terminal
awplus(config)# interface port1.0.2
awplus(config-if)# no mru
```

Related commands [show interface](#)

mtu

Overview Use this command to set the Maximum Transmission Unit (MTU) size for interfaces, where MTU is the maximum packet size that interfaces can transmit. The MTU size setting is applied to both IPv4 and IPv6 packet transmission.

Use the **no** variant of this command to remove a previously specified Maximum Transmission Unit (MTU) size, and restore the default MTU size. For example, the VLAN interface default is 1500 bytes.

Syntax `mtu <68-1582>`
`no mtu`

Parameter	Description
<code><68-1582></code>	The Maximum Transmission size in bytes.

Default The default MTU size, for example 1500 bytes for VLAN interfaces.

Mode Interface Configuration

Usage notes If a device receives an IPv4 packet for Layer 3 switching to another interface with an MTU size smaller than the packet size, and if the packet has the **'don't fragment'** bit set, then the device will send an ICMP **'destination unreachable'** (3) packet type and a **'fragmentation needed and DF set'** (4) code back to the source. For IPv6 packets bigger than the MTU size of the transmitting interface, an ICMP **'packet too big'** (ICMP type 2 code 0) message is sent to the source.

You can set an MTU value on the following interfaces:

- PPP
- Ethernet
- Tunnel
- VLAN

Note that you cannot configure MTU on bridge interfaces. The MTU of the bridge interface is determined by the member interface of the bridge which has the lowest MTU. For example, if you attach eth1 with MTU 1200, ppp1 with MTU 1400, and vlan1 with MTU 1500 to a bridge interface, the MTU for that interface will be 1200.

Note that `show interface` output will only show MTU size for VLAN interfaces.

Examples To configure an MTU size of 1555 bytes on vlan2, use the commands:

```
awplus# configure terminal
awplus(config)# interface vlan2
awplus(config-if)# mtu 1555
```

To configure an MTU size of 1555 bytes for tunnel 'tunnel2', use the commands:

```
awplus# configure terminal
awplus(config)# interface tunnel2
awplus(config-if)# mtu 1555
```

To restore the MTU size to the default MTU size of 1500 bytes on vlan2, use the commands:

```
awplus# configure terminal
awplus(config)# interface vlan2
awplus(config-if)# no mtu
```

Related commands [show interface](#)

Command changes Version 5.4.7-1.1: Behavior change when MTU set to less than 1500 on FS980M and GS980M.

Version 5.5.1-0.1: Layer 3 jumbo frames supported on SBx908 GEN2 and x950.

Version 5.5.1-1.2: Layer 3 jumbo frames supported on x530 and GS980MX.

service statistics interfaces counter

Overview Use this command to enable the interface statistics counter.
Use the **no** variant of this command to disable the interface statistics counter.

Syntax `service statistics interfaces counter`
`no service statistics interfaces counter`

Default The interface statistics counter is enabled by default.

Mode Global Configuration

Example To enable the interface statistics counter, use the following commands:

```
awplus# configure terminal  
awplus(config)# service statistics interfaces counter
```

To disable the interface statistics counter, use the following commands:

```
awplus# configure terminal  
awplus(config)# no service statistics interfaces counter
```

Command changes Version 5.4.7-2.1: command added

show interface

Overview Use this command to display interface configuration and status.

For information on filtering and saving command output, see the [“Getting Started with AlliedWare Plus” Feature Overview and Configuration Guide](#).

Syntax `show interface [<interface-list>]`

Parameter	Description
<code><interface-list></code>	<p>The interfaces or ports to display. An interface-list can be:</p> <ul style="list-style-type: none">• a PPP interface (e.g. ppp0)• an Eth interface (e.g. eth1)• an 802.1Q Ethernet sub-interface (e.g. eth1.10, where ‘10’ is the VLAN ID specified by the encapsulation dot1q command)• a VLAN (e.g. vlan2)• a switchport (e.g. port1.0.4)• a static channel group (e.g. sa2)• a dynamic (LACP) channel group (e.g. po2)• a bridge interface (e.g. br0)• a tunnel interface (e.g. tunnel0)• a 3G cellular interface (e.g. cellular0)• a WWAN interface (e.g. wwan0)• the loopback interface (lo)• a continuous range of interfaces, separated by a hyphen (e.g. ppp2-4)• a comma-separated list (e.g. ppp0,ppp2-4). Do not mix interface types in a list. <p>The specified interfaces must exist.</p>

Mode User Exec and Privileged Exec

Usage notes Note that the output displayed with this command will show MTU (Maximum Transmission Unit) size for VLAN interfaces, and MRU (Maximum Received Unit) size for switch ports.

Example To display configuration and status information for all interfaces, use the command:

```
awplus# show interface
```

Figure 10-1: Example output from the **show interface** command:

```
awplus#show interface
Interface port1.0.1
  Link is UP, administrative state is UP
  Hardware is Ethernet, address is 0000.cd38.026c
  index 5001 metric 1 mru 1500
  current duplex full, current speed 1000, current polarity mdix
  configured duplex auto, configured speed auto, configured polarity auto
  <UP,BROADCAST,RUNNING,MULTICAST>
  SNMP link-status traps: Disabled
  input packets 2927667, bytes 224929311, dropped 0, multicast packets 1242629
  output packets 378084, bytes 54372424, multicast packets 1, broadcast packets 10
  input average rate : 30 seconds 5.19 Kbps, 5 minutes 8.16 Kbps
  output average rate: 30 seconds 6.04 Kbps, 5 minutes 73.89 Kbps
  input peak rate 268.60 Kbps at 2018/04/10 17:46:43
  output peak rate 6.81 Mbps at 2018/04/10 18:15:44
  Time since last state change: 7 days 01:58:10
  ...
```

To display configuration and status information for the loopback interface lo, use the command:

```
awplus# show interface lo
```

Figure 10-2: Example output from the **show interface lo** command:

```
awplus#show interface lo
Interface lo
  Link is UP, administrative state is UP
  Hardware is Loopback
  index 1 metric 1
  <UP,LOOPBACK,RUNNING>
  VRF Binding: Not bound
  SNMP link-status traps: Disabled
  Router Advertisement is disabled
  Router Advertisement default routes are accepted
  Router Advertisement prefix info is accepted
  Time since last state change: 8 days 19:41:47
```

To display configuration and status information for interface vlan1, use the command:

```
awplus# show interface vlan1
```

Figure 10-3: Example output from the **show interface vlan1** command:

```
awplus#show interface vlan1
Interface vlan1
  Link is UP, administrative state is UP
  Hardware is VLAN, address is 0000.cd38.026c
  IPv4 address 192.168.1.1/24 broadcast 192.168.1.255
  index 301 metric 1 mtu 1500
  arp ageing timeout 300
  <UP,BROADCAST,RUNNING,MULTICAST>
  VRF Binding: Not bound
  SNMP link-status traps: Disabled
  Router Advertisement is disabled
  Router Advertisement default routes are accepted
  Router Advertisement prefix info is accepted
  input packets 0, bytes 0, dropped 0, multicast packets 0
  output packets 9, bytes 612, multicast packets 0, broadcast packets 0
  input average rate : 30 seconds 0 bps, 5 minutes 0 bps
  output average rate: 30 seconds 0 bps, 5 minutes 0 bps
  output peak rate 140 bps at 2018/04/10 16:40:56
  Time since last state change: 8 days 19:09:19
```

To display configuration and status information for br1, use the command:

```
awplus# show interface br1
```

```
awplus#show interface br1
Interface br1
  Link is UP, administrative state is UP
  Hardware is Bridge
  IPv6 address fe80::200:cdff:fe38:f7/64
  index 33555969 metric 1
  MAC ageing time 300
  <UP,BROADCAST,RUNNING,MULTICAST>
  SNMP link-status traps: Disabled
  input packets 1328, bytes 143605, dropped 0, multicast packets 0
  output packets 1847, bytes 218999, multicast packets 1 broadcast packets 3
  input average rate : 30 seconds 3.00 Kbps, 5 minutes 1.02 Kbps
  output average rate: 30 seconds 5.32 Kbps, 5 minutes 2.06 Kbps
  input peak rate 8.19 Kbps at 2017/11/13 05:09:59
  output peak rate 17.05 Kbps at 2017/11/13 05:11:23
  Time since last state change: 0 days 00:00:09
```

To display configuration and status information for eth1, use the command:

```
awplus# show interface eth1
```

Figure 10-4: Example output from the **show interface eth1** command:

```
awplus#show interface eth1
Interface eth1
  Link is DOWN, administrative state is UP
  Hardware is Ethernet, address is 0000.cd38.026a
  index 12 metric 1 mtu 1500
  configured duplex auto, configured speed auto, configured polarity auto
  <UP,BROADCAST,MULTICAST>
  VRF Binding: Not bound
  SNMP link-status traps: Disabled
  Bandwidth 1g
  Router Advertisement is disabled
  Router Advertisement default routes are accepted
  Router Advertisement prefix info is accepted
  input packets 0, bytes 0, dropped 0, multicast packets 0
  output packets 11, bytes 5848
  input average rate : 30 seconds 0 bps, 5 minutes 0 bps
  output average rate: 30 seconds 0 bps, 5 minutes 0 bps
  output peak rate 2.48 Kbps at 2018/04/10 18:22:14
  Time since last state change: 7 days 22:56:59
```

Related commands [mru jumbo](#)
[mtu](#)

[show interface brief](#)

[show interface status](#)

Command changes Version 5.4.7-2.1: average rate and peak rate added to output

show interface brief

Overview Use this command to display brief interface, configuration, and status information, including provisioning information.

For information on filtering and saving command output, see the [“Getting Started with AlliedWare Plus” Feature Overview and Configuration Guide](#).

Syntax `show interface brief`

Mode User Exec and Privileged Exec

Output Figure 10-5: Example output from **show interface brief**

```
awplus#show interface brief
Interface          Status           Protocol
port1.0.1         admin up        down
port1.0.2         admin up        down
port1.0.3         admin up        down
port1.0.4         admin up        down
...
eth1              admin up        down
lo               admin up        running
vlan1            admin up        down
ppp1             admin up        down
```

Table 10-1: Parameters in the output of **show interface brief**

Parameter	Description
Interface	The name or type of interface.
Status	The administrative state. This can be either admin up or admin down .
Protocol	The link state. This can be either down , running , or provisioned .

Related commands

- [show interface](#)
- [show interface status](#)
- [show interface memory](#)

show interface memory

Overview This command displays the shared memory used by either all interfaces, or the specified interface or interfaces. The output is useful for diagnostic purposes by Allied Telesis authorized service personnel.

For information on filtering and saving command output, see the [“Getting Started with AlliedWare Plus” Feature Overview and Configuration Guide](#).

Syntax `show interface memory`
`show interface <port-list> memory`

Parameter	Description
<code><port-list></code>	Display information about only the specified port or ports. The port list can be: <ul style="list-style-type: none">• an Eth port (e.g. eth1)• an 802.1Q Ethernet sub-interface (e.g. eth1.10, where ‘10’ is the VLAN ID specified by the encapsulation dot1q command)• a switchport (e.g. port1.0.4)• a static channel group (e.g. sa2)• a dynamic (LACP) channel group (e.g. po2)• a continuous range of ports separated by a hyphen (e.g. port1.0.1-1.0.4)• a comma-separated list (e.g. port1.0.1,port1.0.3-1.0.4). Do not mix port types in the same list.

Mode User Exec and Privileged Exec

Example To display the shared memory used by all interfaces, use the command:

```
awplus# show interface memory
```

To display the shared memory used by port1.0.1 and port1.0.3 to port1.0.4, use the command:

```
awplus# show interface port1.0.1,port1.0.3-port1.0.4 memory
```

Output Figure 10-6: Example output from the **show interface memory** command

```
awplus#show interface memory
Vlan blocking state shared memory usage
-----
Interface  shmid      Bytes Used  natch  Status
port1.0.1  294921     512        1      1
port1.0.2  491535     512        1      1
port1.0.3  458766     512        1      1
...
eth1       393228     512        1      1
lo         360459     512        1      1
```

Figure 10-7: Example output from **show interface <port-list> memory** for a list of interfaces

```
awplus#show interface port1.0.1,port1.0.3-port1.0.4 memory
Vlan blocking state shared memory usage
-----
Interface      shmid      Bytes Used      natch      Status
port1.0.1      589842     512              1
port1.0.3      688149     512              1
port1.0.4      327690     512              1
```

**Related
commands**

- [show interface brief](#)
- [show interface status](#)
- [show interface switchport](#)

show interface status

Overview Use this command to display the status of the specified interface or interfaces. Note that when no interface or interfaces are specified then the status of all interfaces on the device are shown.

Syntax `show interface [<port-list>] status`

Parameter	Description
<port-list>	The ports to display information about. The port list can be: <ul style="list-style-type: none">• an Eth port (e.g. eth1)• an 802.1Q Ethernet sub-interface (e.g. eth1.10, where '10' is the VLAN ID specified by the encapsulation dot1q command)• a switchport (e.g. port1.0.4)• a static channel group (e.g. sa2)• a dynamic (LACP) channel group (e.g. po2)• a continuous range of ports separated by a hyphen (e.g. port1.0.1-1.0.4)• a comma-separated list (e.g. port1.0.1,port1.0.3-1.0.4). Do not mix port types in the same list.

Examples To display the status of port1.0.1 to port1.0.3, use the command:

```
awplus# show interface port1.0.1-port1.0.3 status
```

Table 11: Example output from the **show interface <port-list> status** command

```
awplus#show interface port1.0.1-port1.0.3 status
```

Port	Name	Status	Vlan	Duplex	Speed	Type
port1.0.1		notconnect	1	auto	auto	1000BASE-T
port1.0.2		notconnect	1	auto	auto	1000BASE-T
port1.0.3		notconnect	1	auto	auto	1000BASE-T

To display the status of all ports, use the command:

```
awplus# show interface status
```

Table 12: Example output from the **show interface status** command

```
awplus#show interface status
```

Port	Name	Status	Vlan	Duplex	Speed	Type
port1.0.1	Trunk_Net	connected	trunk	a-full	a-1000	1000BaseTX
port1.0.2	Access_Net1	connected	1	full	1000	1000BaseTX
port1.0.3	Access_Net1	disabled	1	auto	auto	1000BaseTX
...						

Table 13: Parameters in the output from the **show interface status** command

Parameter	Description
Port	Name/Type of the interface.
Name	Description of the interface.
Status	The administrative and operational status of the interface; one of: <ul style="list-style-type: none"> disabled: the interface is administratively down. connect: the interface is operationally up. notconnect: the interface is operationally down.
Vlan	VLAN type or VLAN IDs associated with the port: <ul style="list-style-type: none"> When the VLAN mode is trunk, it displays trunk (it does not display the VLAN IDs). When the VLAN mode is access, it displays the VLAN ID. When the port is an Eth port, it displays none: there is no VLAN associated with it.
Duplex	The actual duplex mode of the interface, preceded by a- if it has autonegotiated this duplex mode. If the port is disabled or not connected, it displays the configured duplex setting.
Speed	The actual link speed of the interface, preceded by a- if it has autonegotiated this speed. If the port is disabled or not connected, it displays the configured speed setting.
Type	The type of interface, e.g. 1000BaseTX. For SFP bays, it displays Unknown if it does not recognize the type of SFP installed, or Not present if an SFP is not installed or is faulty.

Related commands

- [show interface](#)
- [show interface brief](#)
- [show interface memory](#)

shutdown

Overview This command shuts down the selected interface. This administratively disables the link and takes the link down at the physical (electrical) layer.

Use the **no** variant of this command to disable this function and bring the link back up again.

Syntax shutdown
no shutdown

Mode Interface Configuration

Usage notes If you shutdown an aggregator, the device shows the admin status of the aggregator and its component ports as “admin down”. While the aggregator is down, the device accepts **shutdown** and **no shutdown** commands on component ports, but these have no effect on port status. Ports will not come up again while the aggregator is down.

Example To shut down port1.0.1, use the commands:

```
awplus# configure terminal
awplus(config)# interface port1.0.1
awplus(config-if)# shutdown
```

To bring up port1.0.1, use the commands:

```
awplus# configure terminal
awplus(config)# interface port1.0.1
awplus(config-if)# no shutdown
```

To shut down vlan2, use the commands:

```
awplus# configure terminal
awplus(config)# interface vlan2
awplus(config-if)# shutdown
```

To bring up vlan2, use the commands:

```
awplus# configure terminal
awplus(config)# interface vlan2
awplus(config-if)# no shutdown
```

11

3G and 4G USB Cellular Modem Commands

Introduction

Overview This chapter provides an alphabetical reference of commands used to configure USB Cellular Modems.

For more information, see the [3G, 4G Cellular Modem Feature Overview and Configuration Guide](#).

- Command List**
- [“apn”](#) on page 464
 - [“chat-script”](#) on page 466
 - [“cid”](#) on page 467
 - [“encapsulation ppp”](#) on page 468
 - [“show cellular”](#) on page 470
 - [“show system usb”](#) on page 473
 - [“usb mode-switch”](#) on page 475

apn

Overview Use this command to set the Access Point Name (APN) to use to connect to a 3G serial cellular network.

Use the **no** variant of this command to unset the APN.

Syntax `apn <access-point-name>`
`no apn`

Parameter	Description
<code><access-point-name></code>	The APN to use to connect to a cellular network (for example, <code>www.example.com</code>).

Default No APN is set

Mode Interface Configuration (Cellular)

Usage notes The APN has to be set in order to initiate the cellular network connection. Some mobile network operators do not require a specific APN to be specified, in this case any APN can be used.

Examples To set the APN to `www.example.com` for a cellular interface, use the commands:

```
awplus# configure terminal
awplus(config)# int cellular0
awplus(config-if)# apn www.example.com
```

Output Figure 11-1: Example output from the **apn** command

```
awplus#configure terminal
awplus(config)#int cellular0
awplus(config-if)#apn www.example.com
```

To unset the APN, use the commands:

```
awplus# configure terminal
awplus(config)# int cellular0
awplus(config-if)# no apn
```

Output Figure 11-2: Example output from the **no apn** command

```
awplus#configure terminal
awplus(config)#int cellular0
awplus(config-if)#no apn
```

Related commands [chat-script](#)

show cellular
show system usb
usb mode-switch

chat-script

Overview Use this command to set a chat-script, instead of the default chat-script, to connect to a 3G serial cellular network.

Use the **no** variant of this command to set the chat-script back to the default.

Syntax `chat-script <file-name>`
`no chat-script`

Parameter	Description
<code><file-name></code>	The path to the chat-script file (this file has to have a ".chat" extension).

Default The default chat-script is a built-in chat-script that in most cases is sufficient for connecting to a cellular network.

Mode Interface Configuration (Cellular)

Usage notes The chat-script file must have the file extension ".chat". The chat-script consists of a sequence of expect-send pairs of strings. The send strings are AT (Hayes) commands. Any occurrence of the string \$APN in the chat-script will be substituted with the Access Point Name (APN) configured on a cellular interface.

Examples To use a non-default chat-script, "connect.chat", use the commands:

```
awplus# configure terminal
awplus(config)# interface cellular0
awplus(config-if)# #chat-script connect.chat
```

To use the default chat-script, use the commands:

```
awplus# configure terminal
awplus(config)# interface cellular0
awplus(config-if)# #no chat-script
```

Related commands

[apn](#)
[cid](#)
[show cellular](#)
[show system usb](#)
[usb mode-switch](#)

cid

Overview Use this command to set the PDP Context-ID (CID). The customer information in the CID is used to connect to a 3G cellular network.

Use the **no** variant of this command to set the CID back to the default value of 1.

Syntax `cid <context-id>`
`no cid`

Parameter	Description
<code>cid</code>	Context ID (CID) includes identifying information about the mobile customer. For example, the PDP Contexts include the Context-ID that contains the following information: Type, APN, Address, Header Compression, and Status.
<code><context-id></code>	The Context-ID is a number from the range 1 to 10.

Default Context-ID is set to 1

Mode Interface Configuration (cellular)

Usage notes Some cellular modems may have elements of the CID that are read-only.
Use this command to change the CID instead of using a custom chat-script.

Examples To set the Context ID to 2, use the following commands:

```
awplus# configure terminal
awplus(config)# interface cellular0
awplus(config-if)# cid 2
```

To set the Context ID back to the default value of 1, use the following commands:

```
awplus# configure terminal
awplus(config)# interface cellular0
awplus(config-if)# no cid
```

Related commands [apn](#)
[chat-script](#)
[show cellular](#)

Command changes Version 5.4.9-2.1: command added

encapsulation ppp

Overview Use this command to enable PPP encapsulation and create one or more PPP interfaces over Ethernet, a cellular interface, or an L2TPv2 managed VPN.

Use the **no** variant of this command to disable PPP encapsulation and remove the specified PPP interface.

Syntax `encapsulation ppp <index>`
`no encapsulation ppp <index>`

Parameter	Description
<index>	The PPP interface index number in the range from 0 to 255.

Default No PPP encapsulation or interfaces are configured by default.

Mode Interface Configuration mode for an Ethernet interface (e.g. **interface eth1**), or an Ethernet sub-interface (e.g. **interface eth1.1**), or a cellular interface (e.g. **interface cellular0**).

L2TP Tunnel Configuration mode for an L2TP tunnel (e.g. **l2tp tunnel tunnel0**).

Examples To configure a PPP interface with index 0 for Ethernet interface eth1, use the commands:

```
awplus# configure terminal
awplus(config)# interface eth1
awplus(config-if)# encapsulation ppp 0
```

To shut down the ppp0 interface and remove it from Ethernet interface eth1, use the commands:

```
awplus# configure terminal
awplus(config)# interface ppp0
awplus(config-if)# shutdown
awplus(config-if)# interface eth1
awplus(config-if)# no encapsulation ppp 0
```

To set the L2TP tunnel tunnel1 to encapsulate the PPP interface with index 1, use the commands:

```
awplus# configure terminal
awplus(config)# l2tp tunnel tunnel1
awplus(config-l2tp-tunnel)# encapsulation ppp 1
```

To remove the PPP interface with index 1 from L2TP tunnel tunnel1, use the commands:

```
awplus# configure terminal
awplus(config)# l2tp tunnel tunnel1
awplus(config-l2tp-tunnel)# no encapsulation ppp 1
```

**Related
commands**

[l2tp tunnel](#)
[ppp service-name \(PPPoE\)](#)
[show interface \(PPP\)](#)

show cellular

Overview Use this command to display status information about 3G serial USB cellular modems currently plugged into your AR-Series Firewall.

Syntax `show cellular <cellular-interface-name>`

Parameter	Description
<code><cellular-interface-name></code>	Specify the name of a cellular interface. This option displays status information for the cellular modem associated with that interface.

Default None

Mode Privileged Exec

Usage notes If a cellular interface is specified, then the command only shows information for the cellular modem associated with that interface. Different vendors, and models of cellular modems often provide different sets of information:

- Vendor-specific information will not be displayed if the information is unable to be obtained from the cellular modem.
- For information that is common to most cellular modems, "(unknown)" will be displayed if the information was not obtained successfully.

Examples To show status information about all cellular modems, use the command:

```
awplus# show cellular
```

Output Figure 11-3: Example output from **show cellular**

```
awplus#show cellular
Interface cellular0
  Manufacturer: huawei
  Model ID: E1762
  Revision ID: 11.126.10.00.74
  Serial ID: 351553036840711
  IMSI: 530011104647258
  Signal Quality:
    RSSI: -71 dBm
    Bit Error Rate: (unknown)
  Service Center Address:
    Phone Number: +6421600600
    Number Type: International
  GPRS Mobile Station Class: Class A
  Serial Port Configuration:
    Baud rate: 115200
    Character Format: 8-N-1
    Parity: Space
```

```
Terminal Equipment Character Set: IRA
Cable interface DTE-DCE local flow control:
  To DTE: RTS
  To DCE: CTS
System Time: 1980/01/06,03:37:39
GPRS Network Registration Status: Registered, home network
PIN Request Status: READY
Functionality Level: Full functionality (power-saving disabled)
Facility Lock Status:
  SIM card lock: Not active
  SIM fixed dialling memory feature: Not active
  Network personalization: Not active
  Network subset personalization: Not active
  Service provider personalization: Not active
  Corporate personalization: Not active
  Lock phone to first SIM card: Not active
Call Mode: Single mode
Wireless Data Service: 3GPP systems (GERAN, UTRAN and E-UTRAN)
GPRS Service Status: Mobile station is attached to a GPRS service
Dialling Number Type: National
Bearer Service Type:
  Autobauding: Enabled
  Service: Data circuit asynchronous (UDI or 3.1 kHz modem)
  Connection Element: Non-transparent
Automatic time and time zone update via NITS: Not enabled
PPP support between TE and MT: Supported
Last Error Report: No cause information available
PLMN selection method: User controlled PLMN selected from Access Technology
PDP Contexts:
  Context ID: 1
  Type: IP
  APN: www.vodafone.net.nz
  Address: 0.0.0.0
  Header Compression: Off
  Status: Not active
  Primary DNS: 0.0.0.0
  Secondary DNS: 0.0.0.0
  Diagnostic mode baud rate: 115200
  TE-DCE baud rate: 115200
  Tolerance to long delays in PDP call setup: Enabled
  Hardware Version: CD25TCPV
System Info:
  System Service State: Valid service
  System Service Domain: CS and PS service
  Roaming Status: Not roaming
  System Mode: WCDMA mode
  SIM card state: Valid USIM card state
  System Sub-mode: WCDMA mode
System Config:
  Supported System Mode: Auto-select
  Network Acquisition Order: WCDMA, then GSM
  Service Domain Support: CS and PS
Card-Lock:
  Lock Status: Unlock code does not need to be provided
  Remaining Unlock Attempts: 10
  PLMN ID of the operator who has locked this device: None
```

```
Signal Strength:
  RSSI (dBm): -64
  ECIO (dBm): -5
  RSCP (dBm): -69
ICCID: 984610411061462785F5
Software Version: E1762 11.126.10.00.74,CD25TCPV,Ver.B
HSUPA status: Enabled
HSDPA status: Enabled
Card Mode: USIM
Device Mode:
  Mode ID: 20
  Port Modes:
    Port 0: MDM
    Port 1: NDIS
    Port 2: DIAG
    Port 3: PCUI
    Port 4: CDROM
Data Service Traffic:
  Last Connection Time (s): 5134
  Last Bytes Transmitted: 0
  Last Bytes Received: 168
  Total Connection Time (s): 64354
  Total Bytes Transmitted: 910
  Total Bytes Received: 3168
PIN Status:
  Status: READY
  Remaining input attempts:
    PUK: 10
    PIN: 3
    PUK2: 10
    PIN2: 3
```

To show status information about the cellular modem associated with interface 'cellular0' only, use the command:

```
awplus# show cellular cellular0
```

**Related
commands**

[apn](#)
[chat-script](#)
[show system usb](#)
[usb mode-switch](#)

show system usb

Overview Use this command to display technical information about connected USB devices.

Syntax `show system usb [detail]`

Parameter	Description
detail	This option provides greater detail about the USB device, such as descriptors for the device, configuration and Interface.

Default None

Mode Privileged Exec

Examples To show information about USB devices connected to your AR-Series Firewall, use the command:

```
awplus# show system usb
```

Output Figure 11-4: Example output from **show system usb**

```
awplus#show system usb
Bus 001 Device 003: ID 12d1:140c Huawei Technologies Co., Ltd. E180v modem
```

To show greater detail of information about USB devices connected to your AR-Series Firewall, use the command:

```
awplus# show system usb detail
```

Output Figure 11-5: Example output from **show system usb detail**

```
awplus#show system usb detail

Bus 001 Device 002: ID 12d1:1001 Huawei Technologies Co., Ltd. E169/E620/E800 HS
DPA Modem
Device Descriptor:
  bLength                18
  bDescriptorType        1
  bcdUSB                  2.00
  bDeviceClass            0 (Defined at Interface level)
  bDeviceSubClass        0
  bDeviceProtocol         0
  bMaxPacketSize0        64
```

```
idVendor      0x12d1 Huawei Technologies Co., Ltd.
idProduct     0x1001 E169/E620/E800 HSDPA Modem
bcdDevice     0.00
iManufacturer 3 HUAWEI Technology
iProduct      2 HUAWEI Mobile
iSerial       0
bNumConfigurations 1
Configuration Descriptor:
  bLength      9
  bDescriptorType 2
  wTotalLength 85
  bNumInterfaces 3
  bConfigurationValue 1
  iConfiguration 1 Huawei Configuration
  bmAttributes 0xe0
    Self Powered
    Remote Wakeup
  MaxPower    500mA
Interface Descriptor:
  bLength      9
  bDescriptorType 4
  bInterfaceNumber 0
  bAlternateSetting 0
  bNumEndpoints 3
  bInterfaceClass 255 Vendor Specific Class
  bInterfaceSubClass 255 Vendor Specific Subclass
  bInterfaceProtocol 255 Vendor Specific Protocol
  iInterface 0
...

```

- Related commands**
- [apn](#)
 - [chat-script](#)
 - [show cellular](#)
 - [usb mode-switch](#)

usb mode-switch

Overview Use this command to map a specific USB device to a mode-switch configuration file.

The **no** variant of this command removes the configuration corresponding to a specific ID.

Syntax `usb mode-switch id <1-16> vendor-id <vendor-id> product-id <product-id> [manufacturer <manufacturer>|product <product>|serial <serial>|vendor <vendor>|model <model>|revision <revision>] file <file-name>`
`no usb mode-switch id <1-16>`

Parameter	Description
id	mode switch configuration ID.
<1-16>	Configuration ID number (from 1 through 16).
vendor-id	Specify the USB device's vendor ID.
<vendor-id>	4 digit hexadecimal value representing the device's vendor ID.
product-id	Specify the USB device's product ID.
<product-id>	4 digit hexadecimal value representing the device's product ID.
manufacturer	Specify the USB manufacturer descriptor.
<manufacturer>	All or part of the USB manufacturer string descriptor (with spaces replaced by underscores).
product	Specify the USB product descriptor.
<product>	All or part of the USB product string descriptor (with spaces replaced by underscores).
serial	Specify the USB serial descriptor.
<serial>	All or part of the USB serial string descriptor (with spaces replaced by underscores).
vendor	Specify the SCSI vendor descriptor.
<vendor>	All or part of the SCSI model descriptor (with spaces replaced by underscores).
model	Specify the SCSI model descriptor.
<model>	All or part of the SCSI revision descriptor (with spaces replaced by underscores).
revision	Specify the SCSI revision descriptor.
<revision>	All or part of the SCSI revision descriptor (with spaces replaced by underscores).

Parameter	Description
file	Specify the mode switch config file to be used instead of the default when the target device is inserted.
<file>	Mode switch configuration file URL with extension .conf.

Default Some USB devices will use a default mode switch configuration file if one is not specified.

Mode Global Configuration

Usage notes Some USB devices must be explicitly told to switch to a compatible mode. The **usb mode-switch** command does this by matching on a target device by its USB vendor and product IDs, and executing a specified configuration file.

Additional parameters can be defined which specify other USB and SCSI descriptors. These are useful if there are multiple devices that have the same product and vendor IDs, but differ in the other parameters. The mode switch configuration files must have the extension “.conf”.

Examples To add a mode switch configuration for a USB device, use the commands:

```
awplus# configure terminal
awplus(config)# usb mode-switch id 1 vendor-id 12d1 product-id
140c manufacturer HUAWEI file switch.conf
```

To remove a mode switch configuration for a USB device, use the commands:

```
awplus# configure terminal
awplus(config)# no usb mode-switch id 1
```

Related commands

- apn
- chat-script
- show cellular
- show system usb
- usb mode-switch

12

Port Mirroring Commands

Introduction

Overview This chapter provides an alphabetical reference of commands used to configure Port Mirroring.

For more information, see the [Mirroring Feature Overview and Configuration Guide](#).

- Command List**
- [“mirror interface”](#) on page 478
 - [“show mirror”](#) on page 480
 - [“show mirror interface”](#) on page 481

mirror interface

Overview Use this command to define a mirror port and mirrored (monitored) ports and direction of traffic to be mirrored. The port for which you enter interface mode will be the mirror port.

The destination port is removed from all VLANs, and no longer participates in other switching.

Use the **no** variant of this command to disable port mirroring by the destination port on the specified source port.

Syntax

```
mirror interface <source-port-list> direction  
{both|receive|transmit}  
  
no mirror interface <source-port-list>
```

Parameter	Description
<source-port-list>	The source switch ports to mirror. A port-list can be: <ul style="list-style-type: none">• a port (e.g. port1.0.2)• a continuous range of ports separated by a hyphen, e.g. port1.0.1-port1.0.3• a comma-separated list of ports and port ranges, e.g. port1.0.1,port1.0.2-port1.0.4 The source port list cannot include dynamic or static channel groups (link aggregators).
direction	Specifies whether to mirror traffic that the source port receives, transmits, or both.
both	Mirroring traffic both received and transmitted by the source port.
receive	Mirroring traffic received by the source port.
transmit	Mirroring traffic transmitted by the source port.

Mode Interface Configuration

Usage notes Use this command to send traffic to another device connected to the mirror port for monitoring.

For more information, see the [Mirroring Feature Overview and Configuration Guide](#).

A mirror port cannot be associated with a VLAN. If a switch port is configured to be a mirror port, it is automatically removed from any VLAN it was associated with.

This command can only be applied to a single mirror (destination) port, not to a range of ports, nor to a static or dynamic channel group. Do not apply multiple interfaces with an interface command before issuing the mirror interface command. One interface may have multiple mirror interfaces.

Example To mirror traffic received and transmitted on port1.0.1 to destination port1.0.2, use the commands:

```
awplus# configure terminal
awplus(config)# interface port1.0.2
awplus(config-if)# mirror interface port1.0.1 direction both
```

show mirror

Overview Use this command to display the status of all mirrored ports.

Syntax `show mirror`

Mode User Exec and Privileged Exec

Example To display the status of all mirrored ports, use the following command:

```
awplus# show mirror
```

Output Figure 12-1: Example output from the **show mirror** command

```
Mirror Test Port Name: port1.0.1  
Mirror option: Enabled  
Mirror direction: both  
Monitored Port Name: port1.0.2
```

show mirror interface

Overview Use this command to display port mirroring configuration for a mirrored (monitored) switch port.

Syntax `show mirror interface <port>`

Parameter	Description
<code><port></code>	The monitored switch port to display information about.

Mode User Exec, Privileged Exec and Interface Configuration

Example To display port mirroring configuration for port1.0.2, use the following commands:

```
awplus# configure terminal
awplus(config)# interface port1.0.2
awplus(config-if)# show mirror interface port1.0.2
```

Output Figure 12-2: Example output from the **show mirror interface** command

```
Mirror Test Port Name: port1.0.1
Mirror option: Enabled
Mirror direction: both
Monitored Port Name: port1.0.2
```

Part 2: Interfaces and Layer 2

13

Switching Commands

Introduction

Overview This chapter provides an alphabetical reference of commands used to configure switching.

For more information, see the [Switching Feature Overview and Configuration Guide](#).

- Command List**
- [“backpressure”](#) on page 485
 - [“clear mac address-table dynamic”](#) on page 487
 - [“clear mac address-table static”](#) on page 488
 - [“clear port counter”](#) on page 489
 - [“debug platform packet”](#) on page 490
 - [“duplex”](#) on page 492
 - [“flowcontrol \(switch port\)”](#) on page 493
 - [“linkflap action”](#) on page 495
 - [“mac address-table acquire”](#) on page 496
 - [“mac address-table ageing-time”](#) on page 497
 - [“mac address-table static”](#) on page 498
 - [“platform multicast-ratelimit”](#) on page 499
 - [“polarity”](#) on page 500
 - [“show debugging platform packet”](#) on page 501
 - [“show flowcontrol interface”](#) on page 502
 - [“show interface err-disabled”](#) on page 503
 - [“show interface switchport”](#) on page 504
 - [“show mac address-table”](#) on page 505

- [“show platform”](#) on page 507
- [“show platform port”](#) on page 509
- [“show storm-control”](#) on page 511
- [“speed”](#) on page 512
- [“storm-control level”](#) on page 514
- [“undebbug platform packet”](#) on page 515

backpressure

Overview This command provides a method of applying flow control to ports running in half duplex mode. The setting will only apply when the link is in the half-duplex state.

You can disable backpressure on an interface using the **off** parameter or the **no** variant of this command.

Syntax `backpressure {on|off}`
`no backpressure`

Parameters	Description
on	Enables half-duplex flow control.
off	Disables half-duplex flow control.

Default Backpressure is turned off by default. You can determine whether an interface has backpressure enabled by viewing the running-config output; **backpressure on** is shown for interfaces if this feature is enabled.

Mode Interface Configuration

Usage notes The backpressure feature enables half duplex Ethernet ports to control traffic flow during congestion by preventing further packets arriving. Backpressure utilizes a pre-802.3x mechanism in order to apply Ethernet flow control to switch ports that are configured in the half duplex mode.

The flow control applied by the [flowcontrol \(switch port\)](#) command operates only on full-duplex links, whereas backpressure operates only on half-duplex links.

If a port has insufficient capacity to receive further frames, the device will simulate a collision by transmitting a CSMA/CD jamming signal from this port until the buffer empties. The jamming signal causes the sending device to stop transmitting and wait a random period of time, before retransmitting its data, thus providing time for the buffer to clear. Although this command is only valid for switch ports operating in half-duplex mode the remote device (the one sending the data) can be operating in the full duplex mode.

To see the currently-negotiated duplex mode for ports whose links are up, use the command [show interface](#). To see the configured duplex mode (when different from the default), use the command [show running-config](#).

Examples To enable backpressure flow control on port1.0.2, enter the following commands:

```
awplus# configure terminal
awplus(config)# interface port1.0.2
awplus(config-if)# backpressure on
```

To disable backpressure flow control on interface port1.0.2, enter the following commands:

```
awplus# configure terminal
awplus(config)# interface port1.0.2
awplus(config-if)# backpressure off
```

**Related
commands**

[duplex](#)
[show interface](#)
[show running-config](#)

clear mac address-table dynamic

Overview Use this command to clear the filtering database of all entries learned for a selected MAC address, a switch port interface, or a VLAN interface.

Syntax `clear mac address-table dynamic`
`[address <mac-address>|interface <port>|vlan <vid>]`

Parameter	Description
<code>address</code> <code><mac-address></code>	Specify a MAC (Media Access Control) address to be cleared from the filtering database, in the format HHHH.HHHH.HHHH.
<code>interface <port></code>	Specify a switch port to be cleared from the filtering database. The port can be: <ul style="list-style-type: none">• a switchport (e.g. port1.0.4)• a static channel group (e.g. sa2)• a dynamic (LACP) channel group (e.g. po2)
<code>vlan <vid></code>	Specify a VID (VLAN ID) in the range 1 to 4094 to be cleared from the filtering database.

Mode Privileged Exec

Usage notes Use this command with options to clear the filtering database of all entries learned for a given MAC address, interface or VLAN. Use this command without options to clear any learned entries.

Examples This example shows how to clear all dynamically learned filtering database entries.

```
awplus# clear mac address-table dynamic
```

This example shows how to clear all dynamically learned filtering database entries when learned through device operation for the MAC address 0000.5E00.5302.

```
awplus# clear mac address-table dynamic address 0000.5E00.5302
```

Related commands [clear mac address-table static](#)
[show mac address-table](#)

clear mac address-table static

Overview Use this command to clear the filtering database of all statically configured entries for a selected MAC address, interface, or VLAN.

Syntax `clear mac address-table static [address <mac-address>|interface <port>|vlan <vid>]`

Parameter	Description
<code>address <mac-address></code>	Specify a MAC (Media Access Control) address to be cleared from the filtering database, in the format HHHH.HHHH.HHHH.
<code>interface <port></code>	Specify the port from which statically configured entries are to be cleared. The port can be <ul style="list-style-type: none">• a switchport (e.g. port1.0.4)• a static channel group (e.g. sa2)• a dynamic (LACP) channel group (e.g. po2)
<code>vlan <vid></code>	Specify a VID (VLAN ID) in the range 1 to 4094 to be cleared from the filtering database.

Mode Privileged Exec

Usage notes Use this command with options to clear the filtering database of all entries made from the CLI for a given MAC address, interface or VLAN. Use this command without options to clear any entries made from the CLI.

Compare this usage with [clear mac address-table dynamic](#) command.

Examples This example shows how to clear all filtering database entries configured through the CLI.

```
awplus# clear mac address-table static
```

This example shows how to clear all filtering database entries for a specific interface configured through the CLI.

```
awplus# clear mac address-table static interface port1.0.3
```

This example shows how to clear filtering database entries configured through the CLI for the MAC address 0000.5E00.5302.

```
awplus# clear mac address-table static address 0000.5E00.5302
```

Related commands

- [clear mac address-table dynamic](#)
- [mac address-table static](#)
- [show mac address-table](#)

clear port counter

Overview Use this command to clear the packet counters of the port.

Syntax `clear port counter [<port>]`

Parameter	Description
<code><port></code>	The port number or range

Mode Privileged Exec

Example To clear the packet counter for port1.0.1, use the command:

```
awplus# clear port counter port1.0.1
```

Related commands [show platform port](#)

debug platform packet

Overview This command enables platform to CPU level packet debug functionality on the device.

Use the **no** variant of this command to disable platform to CPU level packet debug. If the result means both send and receive packet debug are disabled, then any active timeout will be canceled.

Syntax `debug platform packet [recv] [send] [timeout <timeout>] [vlan <vid>|all]`

`no debug platform packet [recv] [send]`

Parameter	Description
recv	Debug packets received.
send	Debug packets sent.
timeout <timeout>	Stop debug after a specified time. Specify the time in seconds.
vlan <vid>	Specify a VID (VLAN ID) in the range 1 to 4094 to limit debug to that VLAN.
all	Debug all VLANs (default setting).

Default A 5 minute timeout is configured by default if no other timeout duration is specified.

Mode Privileged Exec and Global Configuration

Usage notes This command can be used to trace packets sent and received by the CPU. If a timeout is not specified, then a default 5 minute timeout will be applied.

If a timeout of 0 is specified, packet debug will be generated until the **no** variant of this command is used or another timeout value is specified. The timeout value applies to both send and receive debug and is updated whenever the **debug platform packet** command is used.

Examples To enable both receive and send packet debug for the default timeout of 5 minutes, enter:

```
awplus# debug platform packet
```

To enable receive packet debug for 10 seconds, enter:

```
awplus# debug platform packet recv timeout 10
```

To enable send packet debug with no timeout, enter:

```
awplus# debug platform packet send timeout 0
```

To enable VLAN packet debug for VLAN 1 with a timeout duration of 3 minutes, enter:

```
awplus# debug platform packet vlan 1 timeout 180
```

To disable receive packet debug, enter:

```
awplus# no debug platform packet recv
```

Related commands [show debugging platform packet](#)
[undebug platform packet](#)

duplex

Overview This command changes the duplex mode for the specified port.

To see the currently-negotiated duplex mode for ports whose links are up, use the command [show interface](#). To see the configured duplex mode (when different from the default), use the command [show running-config](#).

Syntax duplex {auto|full|half}

Parameter	Description
auto	Auto-negotiate duplex mode.
full	Operate in full duplex mode only.
half	Operate in half duplex mode only.

Default By default, ports auto-negotiate duplex mode (except for 100Base-FX ports which do not support auto-negotiation, so default to full duplex mode).

Mode Interface Configuration

Usage notes Switch ports in a static or dynamic (LACP) channel group must have the same port speed and be in full duplex mode. Once switch ports have been aggregated into a channel group, you can set the duplex mode of all the switch ports in the channel group by applying this command to the channel group.

Examples To specify full duplex for port1.0.4, enter the following commands:

```
awplus# configure terminal
awplus(config)# interface port1.0.4
awplus(config-if)# duplex full
```

To specify half duplex for port1.0.4, enter the following commands:

```
awplus# configure terminal
awplus(config)# interface port1.0.4
awplus(config-if)# duplex half
```

To auto-negotiate duplex mode for port1.0.4, enter the following commands:

```
awplus# configure terminal
awplus(config)# interface port1.0.4
awplus(config-if)# duplex auto
```

Related commands

- [polarity](#)
- [speed](#)
- [show interface](#)

flowcontrol (switch port)

Overview Use this command to enable flow control, and configure the flow control mode for the switch port.

Use the **no** variant of this command to disable flow control for the specified switch port.

Syntax `flowcontrol both`
`flowcontrol {receive|send} {off|on}`
`no flowcontrol`

Parameter	Description
<code>both</code>	Use this parameter to specify send and receive flow control for the port.
<code>receive</code>	When the port receives pause frames, it temporarily stops (pauses) sending traffic.
<code>send</code>	When the port is congested (receiving too much traffic), it sends pause frames to request the other end to temporarily stop (pause) sending traffic.
<code>on</code>	Enable the specified flow control.
<code>off</code>	Disable the specified flow control.

Default By default, flow control is disabled.

Mode Interface Configuration

Usage notes The flow control mechanism specified by 802.3x is only for full duplex links. It operates by sending PAUSE frames to the link partner to temporarily suspend transmission on the link.

Flow control enables connected Ethernet ports to control traffic rates during congestion by allowing congested nodes to pause link operation at the other end. If one port experiences congestion, and cannot receive any more traffic, it notifies the other port to stop sending until the condition clears. When the local device detects congestion at its end, it notifies the remote device by sending a pause frame. On receiving a pause frame, the remote device stops sending data packets, which prevents loss of data packets during the congestion period.

For half-duplex links, an older form of flow control known as backpressure is supported. See the related [backpressure](#) command.

For flow control on async serial (console) ports, see the [flowcontrol hardware \(asyn/console\)](#) command.

Examples To enable flow control on port1.0.2, use the commands:

```
awplus# configure terminal
awplus(config)# interface port1.0.2
awplus(config-if)# flowcontrol both
```

To disable flow control on port1.0.2, use the commands:

```
awplus# configure terminal
awplus(config)# interface port1.0.2
awplus(config-if)# no flowcontrol
```

To enable flow control on port1.0.2 (receive only), use the commands:

```
awplus# configure terminal
awplus(config)# interface port1.0.2
awplus(config-if)# flowcontrol receive on
```

To enable flow control on port1.0.2 (send only), use the commands:

```
awplus# configure terminal
awplus(config)# interface port1.0.2
awplus(config-if)# flowcontrol send on
```

To disable flow control on port1.0.2 (receive only), use the commands:

```
awplus# configure terminal
awplus(config)# interface port1.0.2
awplus(config-if)# flowcontrol receive off
```

To disable flow control on port1.0.2 (send only), use the commands:

```
awplus# configure terminal
awplus(config)# interface port1.0.2
awplus(config-if)# flowcontrol send off
```

Related commands [backpressure](#)
[show running-config](#)

linkflap action

Overview Use this command to detect flapping on all ports. If more than 15 flaps occur in less than 15 seconds the flapping port will shut down.

Use the **no** variant of this command to disable flapping detection at this rate.

Syntax linkflap action [shutdown]
no linkflap action

Parameter	Description
linkflap	Global setting for link flapping.
action	Specify the action for port.
shutdown	Shutdown the port.

Default Linkflap action is disabled by default.

Mode Global Configuration

Example To enable the linkflap action command on the device, use the following commands:

```
awplus# configure terminal  
awplus(config)# linkflap action shutdown
```

mac address-table acquire

Overview Use this command to enable MAC address learning on the device.

Use the **no** variant of this command to disable learning.

Syntax `mac address-table acquire`
`no mac address-table acquire`

Default Learning is enabled by default for all instances.

Mode Global Configuration

Example `awplus# configure terminal`
`awplus(config)# mac address-table acquire`

mac address-table ageing-time

Overview Use this command to specify an ageing-out time for a learned MAC address. The learned MAC address will persist for at least the specified time.

The **no** variant of this command will reset the ageing-out time back to the default of 300 seconds (5 minutes).

Syntax `mac address-table ageing-time <ageing-timer> none`
`no mac address-table ageing-time`

Parameter	Description
<code><ageing-timer></code>	<code><10-1000000></code> The number of seconds of persistence.
<code>none</code>	Disable learned MAC address timeout.

Default The default ageing time is 300 seconds.

Mode Global Configuration

Examples The following commands specify various ageing timeouts on the device:

```
awplus# configure terminal
awplus(config)# mac address-table ageing-time 1000
awplus# configure terminal
awplus(config)# mac address-table ageing-time none
awplus# configure terminal
awplus(config)# no mac address-table ageing-time
```

mac address-table static

Overview Use this command to statically configure the MAC address-table to forward or discard frames with a matching destination MAC address.

Syntax `mac address-table static <mac-addr> {forward|discard} interface <port> [vlan <vid>]`
`no mac address-table static <mac-addr> {forward|discard} interface <port> [vlan <vid>]`

Parameter	Description
<code><mac-addr></code>	The destination MAC address in HHHH . HHHH . HHHH format.
<code>interface <port></code>	Specify a switch port to be cleared from the filtering database. The port can be: <ul style="list-style-type: none">• a switchport (e.g. port1.0.4)• a static channel group (e.g. sa2)• a dynamic (LACP) channel group (e.g. po2)
<code>vlan <vid></code>	The ID of a VLAN to apply the command to, in the range 1 to 4094. If you do not specify a VLAN, the command applies to VLAN1.

Mode Global Configuration

Usage notes The **mac address-table static** command is only applicable to Layer 2 switched traffic within a single VLAN. Do not apply the **mac address-table static** command to Layer 3 switched traffic passing from one VLAN to another VLAN. Frames will not be discarded across VLANs because packets are routed across VLANs. This command only works on Layer 2 traffic.

Example `awplus# configure terminal`
`awplus(config)# mac address-table static 2222.2222.2222 forward`
`interface port1.0.4 vlan 3`

Related commands [clear mac address-table static](#)
[show mac address-table](#)

platform multicast-ratelimit

Overview Use this command to set the maximum number of multicast packets to be forwarded to the CPU (in packets per second). Setting the value to zero disables rate limiting.

This command should be used with care. Increasing or removing the limit could make the device less responsive under heavy multicast load.

Use the **no** variant of this command to return the limit to its default.

Syntax `platform multicast-ratelimit <0-1000>`
`no platform multicast-ratelimit`

Default 10 packets per second (pps)

Mode Global Configuration

Usage notes If you find that the CPU load on your device from multicast traffic is higher than desired, reducing this rate may reduce the CPU load.

If you need the device to process a large amount of multicast traffic, increasing this rate may improve performance.

Example To set the rate to 30pps, use the commands:

```
awplus# configure terminal
awplus(config)# platform multicast-ratelimit 30
```

Command changes Version 5.4.8-1.1: default changed to 100pps on SBx908 GEN2, SBx8100, and x930 Series switches.

polarity

Overview This command sets the MDI/MDIX polarity on a copper-based switch port.

Syntax `polarity {auto|mdi|mdix}`

Parameter	Description
mdi	Sets the polarity to MDI (medium dependent interface).
mdix	Sets the polarity to MDI-X (medium dependent interface crossover).
auto	The switch port sets the polarity automatically. This is the default option.

Default By default, switch ports set the polarity automatically (**auto**).

Mode Interface Configuration

Usage notes We recommend the default **auto** setting for MDI/MDIX polarity. Polarity applies to copper 10BASE-T, 100BASE-T, and 1000BASE-T switch ports; it does not apply to fiber ports. See the “MDI/MDIX Connection Modes” section in the [Switching Feature Overview and Configuration Guide](#) for more information.

Example To set the polarity for port1.0.4 to fixed MDI mode, use the following commands:

```
awplus# configure terminal
awplus(config)# interface port1.0.4
awplus(config-if)# polarity mdi
```

show debugging platform packet

Overview This command shows platform to CPU level packet debugging information.

Syntax show debugging platform packet

Mode User Exec and Privileged Exec

Example To display the platform packet debugging information, use the command:

```
awplus# show debugging platform packet
```

Related commands [debug platform packet](#)
[undebg platform packet](#)

show flowcontrol interface

Overview Use this command to display flow control information.

Syntax show flowcontrol interface <port>

Parameter	Description
<port>	Specifies the name of the port to be displayed.

Mode User Exec and Privileged Exec

Example To display the flow control for port1.0.3, use the command:

```
awplus# show flowcontrol interface port1.0.3
```

Output Figure 13-1: Example output from the **show flowcontrol interface** command for a specific interface

Port	Send admin	FlowControl oper	Receive admin	FlowControl oper	RxPause	TxPause
port1.0.3	on	on	on	on	0	0

show interface err-disabled

Overview Use this command to show the ports which have been dynamically shut down by protocols running on the device and the protocols responsible for the shutdown.

Syntax `show interface [<interface-range> err-disabled]`

Parameter	Description
<code><interface-range></code>	Interface range
<code>err-disabled</code>	Brief summary of interfaces shut down by protocols

Mode User Exec and Privileged Exec

Example To show which protocols have shut down ports, use the commands:

```
awplus# show interface err-disabled
```

show interface switchport

Overview Use this command to show VLAN information about each switch port.

Syntax `show interface switchport`

Mode User Exec and Privileged Exec

Example To display VLAN information about each switch port, enter the command:

```
awplus# show interface switchport
```

Output Figure 13-2: Example output from the **show interface switchport** command

```
Interface name      : port1.0.1
Switchport mode    : access
Ingress filter     : enable
Acceptable frame types : all
Default Vlan       : 1
Configured Vlans   : 2
Dynamic Vlans      :

Interface name      : port1.0.2
Switchport mode    : trunk
Ingress filter     : enable
Acceptable frame types : all
Default Vlan       : 1
Configured Vlans   : 1 4 5 6 7 8
Dynamic Vlans      :
...
```

Related commands [show interface memory](#)
[show vlan](#)

show mac address-table

Overview Use this command to display the MAC address-table for all configured VLANs.

Syntax show mac address-table

Mode User Exec and Privileged Exec

Usage notes The **show mac address-table** command is only applicable to view a MAC address-table for Layer 2 switched traffic within VLANs.

Example To display the MAC address-table, use the following command:

```
awplus# show mac address-table
```

Output See the following sample output captured when there was no traffic being switched:

```
awplus#show mac address-table

VLAN port      mac                type
1     unknown      0000.cd28.0752    forward  static
ARP  -             0000.cd00.0000    forward  static
```

See the sample output captured when packets were switched and MAC addresses were learned:

```
awplus#show mac address-table

VLAN port      mac                type
1     unknown      0000.cd28.0752    forward  static
1     port1.0.2    0030.846e.9bf4    forward  dynamic
1     port1.0.3    0030.846e.bac7    forward  dynamic
ARP  -             0000.cd00.0000    forward  static
```

Note the new MAC addresses learned for port1.0.2 and port1.0.3 added as dynamic entries.

Note the first column of the output below shows VLAN IDs if multiple VLANs are configured:

```
awplus#show mac address-table

VLAN port      mac                type
1     unknown      0000.cd28.0752    forward  static
1     port1.0.2    0030.846e.bac7    forward  dynamic
2     unknown      0000.cd28.0752    forward  static
2     port1.0.3    0030.846e.9bf4    forward  dynamic
ARP  -             0000.cd00.0000    forward  static
```

Also note if manually configured static MAC addresses exist, this is shown to the right of the type column:

```
awplus(config)#mac address-table static 0000.1111.2222 for int
port1.0.3 vlan 1
awplus(config)#end
awplus#
awplus#show mac address-table
```

VLAN	port	mac	type	
1	unknown	0000.cd28.0752	forward	static
1	port1.0.2	0030.846e.bac7	forward	dynamic
1	port1.0.3	0000.1111.2222	forward	static
...				

**Related
commands**

- [clear mac address-table dynamic](#)
- [clear mac address-table static](#)
- [mac address-table static](#)

show platform

Overview This command displays the settings configured by using the **platform** commands.

Syntax `show platform`

Mode Privileged Exec

Usage notes This command displays the settings in the running config. For changes in some of these settings to take effect, the device must be rebooted with the new settings in the startup config.

Example To check the settings configured with **platform** commands on the device, use the following command:

```
awplus# show platform
```

Output Figure 13-3: Example output from the **show platform** command:

```
awplus#show platform
MAC vlan hashing algorithm    unknown
```

Table 1: Parameters in the output of the **show platform** command. Note that the parameters displayed depend on your device, and that not all displayed parameters can be modified on all devices.

Parameter	Description
Routing Ratio	Whether all memory is allocated to IPv4 address table entries only, or whether it is allocated evenly to both IPv4 and IPv6 addresses (set with the platform routingratio command).
Route Weighting	The split between multicast and unicast route entries (set with the platform routingratio command).
MAC vlan hashing algorithm	The MAC VLAN hash-key-generating algorithm (set with the platform mac-vlan-hashing-algorithm command). The default algorithm is crc32l. The algorithm may need to be changed in rare circumstances in which hash collisions occur.
L3 hashing algorithm	The L3 VLAN hash-key-generating algorithm (set with the platform l3-vlan-hashing-algorithm command). The default algorithm is crc32l. The algorithm may need to be changed in rare circumstances in which hash collisions occur.
Load Balancing	Which packet fields are used in the channel load balancing algorithm (set with the platform load-balancing command).
Control-plane-prioritization	Maximum traffic rate on the CPU port (set with the platform control-plane-prioritization rate command).

Table 1: Parameters in the output of the **show platform** command. Note that the parameters displayed depend on your device, and that not all displayed parameters can be modified on all devices. (cont.)

Parameter	Description
Fdb-chain-length	The length of the FDB hash chain (set with the platform fdb-chain-length command). FDB entries are hashed and indexed using a hash. In rare circumstances it may be useful to reduce the chain length.
L2MC overlapped group check	Whether Layer 2 multicast entries are checked before deletion (set with the platform l2mc-overlap command).
silicon-profile	The silicon profile setting (set with the platform silicon-profile command) for the switch hardware; one of: <ul style="list-style-type: none"> • profile 1 • profile 2 • profile 3 • None (default)
fdb-l3-hosts mode	Whether Host Mode is turned on or not. Host Mode increases the number of host entries and is available for systems containing SBx81CFC960 controller cards and SBx81XLEM line cards. See platform silicon-profile and platform fdb-l3-hosts for details.
Jumboframe support	Whether the jumbo frames setting is enabled or disabled (set with the platform jumboframe command).
Traffic Manager	A test setting that is disabled by default.
stop-unreg-mc-flooding	Whether the stop-unreg-mc-flooding feature is on or off (set with the platform stop-unreg-mc-flooding command). This feature prevents flooding of unregistered multicast packets in the occasional situations in which IGMP snooping does not prevent it.
Port Mode	Whether each port on the AT-StackQS is configured as one 40Gbps port or four 10Gbps ports, if they are operating as network ports (set with the platform portmode interface command).
Vlan-stacking TPID	The value of the TPID set in the Ethernet type field when a frame has a double VLAN tag (set with the platform vlan-stacking-tpid command).
PBR enabled	Whether policy-based routing is globally enabled or not (set with the platform pbr-enable command).
Hardware Filter Size	Whether hardware ACLs can filter on IPv6 addresses (ipv4-full-ipv6) or not (ipv4-limited-ipv6). This is set with the platform hwfilter-size command.
Vlan Ingress Filter Hard Drop	The Bridge Vlan Ingress Filtering drops traffic if the VID assigned to the packet does not match with the port's VLAN membership. There are two ways the traffic is dropped by the Ingress Filtering mechanism: <ul style="list-style-type: none"> • HARD DROP - Traffic is dropped by the Bridge Engine and not forwarded or trapped. • SOFT DROP - Traffic may be mirrored or trapped by the Bridge Engine.

show platform port

Overview This command displays the various port registers or platform counters for specified switchports.

Syntax `show platform port [<port-list>] [counters]`

Parameter	Description
<code><port-list></code>	The ports to display information about. A port-list can be: <ul style="list-style-type: none">• a switchport (e.g. port1.0.4)• a continuous range of ports separated by a hyphen (e.g. port1.0.1-1.0.4)• a comma-separated list (e.g. port1.0.1,port1.0.3-1.0.4).
<code>counters</code>	Show the platform counters.

Mode Privileged Exec

Examples To display port registers for port1.0.1 to port1.0.4, use the command:

```
awplus# show platform port port1.0.1-port1.0.4
```

To display platform counters for port1.0.1 to port1.0.4, use the command:

```
awplus# show platform port port1.0.1-port1.0.4 counters
```

Output Figure 13-4: Example output from the **show platform port** command

```
awplus#show platform port port1.0.1
Phy register value for port1.0.1 (ifindex: 5001)

00:1140 01:7949 02:0362 03:5e14 04:01e1 05:0000 06:0064 07:2001
08:0000 09:0600 0a:0000 0b:0000 0c:0000 0d:4007 0e:0000 0f:3000
10:0020 11:0000 12:0000 13:0000 14:0000 15:0000 16:0000 17:0000
18:7277 19:1000 1a:0000 1b:ffff 1c:6cc7 1d:0000 1e:0000 1f:0000
sfp phy
00:1140 01:7949 02:0362 03:5e14 04:01e1 05:0000 06:0064 07:2001
08:0000 09:0600 0a:0000 0b:0000 0c:0000 0d:4007 0e:0000 0f:3000
10:0020 11:0000 12:0000 13:0000 14:0000 15:0000 16:0000 17:0000
18:7277 19:1000 1a:0000 1b:ffff 1c:6cc7 1d:0000 1e:0000 1f:0000

Port configuration for lport 0x08000000:
Phy Driver: 54680 Gigabit PHY Driver
enabled: 1
loopback: 0
link: 0
speed: 0 max speed: 1000
duplex: 0
linkscan: 1
autonegotiate: 1
master: 2
tx pause: 0 rx pause: 0
untagged vlan: 1
vlan filter: 1
stp state: 1
learn: 5
discard: 0
jam: 0
max frame size: 1518
MC Disable SA: no
MC Disable TTL: no
MC egress untag: 0
MC egress vid: 0
MC TTL threshold: 0
```

show storm-control

Overview Use this command to display storm-control information for all interfaces or a particular interface.

Syntax `show storm-control [<port>]`

Parameter	Description
<code><port></code>	The port to display information about. The port may be: <ul style="list-style-type: none">• a switchport (e.g. port1.0.4)• a static channel group (e.g. sa2)• a dynamic (LACP) channel group (e.g. po2)

Mode User Exec and Privileged Exec

Example To display storm-control information for port1.0.2, use the following command:

```
awplus# show storm-control port1.0.2
```

Output Figure 13-5: Example output from the **show storm-control** command for port1.0.2

Port	BcastLevel	McastLevel	DlfLevel
port1.0.2	40.0%	100.0%	100.0%

Related commands [storm-control level](#)

speed

Overview This command changes the speed of the specified port. You can optionally specify the speed or speeds that get autonegotiated, so autonegotiation is only attempted at the specified speeds.

To see the currently-negotiated speed for ports whose links are up, use the [show interface](#) command. To see the configured speed (when different from the default), use the [show running-config](#) command.

Depending on your switch model and the SFP or SFP+ modules you use, a subset of the following speed options will be available.

Syntax `speed {10|100|1000|2500|5000|10000|40000|100000}`
`speed auto [10] [100] [1000] [2500] [5000] [10000] [40000]`
`[100000]`

The following table shows the speed options for each type of port, depending on the model.

Port type	Speed Options (units are Mbps)
RJ5 copper ports	auto (default) 10 100 1000
RJ-45 copper ports	auto (default) 10 100 1000 2500 5000 10000
tri-speed copper SFPs	auto (default) 10 100 1000
100 Mbps fiber SFPs	100
1000 Mbps fiber SFPs	auto (default) 1000
1000 Mbps copper SFPs	auto (default) 1000
1000 Mbps fiber CSFPs (Compact SFPs)	auto (default) 1000
Multi-speed copper SFP+	auto (default) 1000 2500 5000 10000

Port type	Speed Options (units are Mbps)
10000 Mbps fiber SFP+	auto (default) 10000
10000 Mbps copper SFP+	auto (default) 10000
10000 Mbps Direct Attach Cable (DAC)	auto (default) 10000
40000 Mbps QSFP+	auto (default) 40000
40000 Mbps Direct Attach Cable (DAC)	auto (default) 40000
Breakout DACs for 4 x 10G connections	auto (default) 10000
100000 Mbps QSFP28	auto (default) 100000

Mode Interface Configuration

Default By default, ports autonegotiate speed.

Usage notes We recommend having autonegotiation enabled for link speeds of 1000 Mbps and above. For example, to apply a fixed speed of 1000 Mbps use the command **speed auto 1000**.

If multiple speeds are specified after the auto option to autonegotiate speeds, then the device only attempts autonegotiation at those specified speeds.

Switch ports in a static or dynamic (LACP) channel group must have the same port speed and be in full duplex mode. Once switch ports have been aggregated into a channel group, you can set the speed of all the switch ports in the channel group by applying this command to the channel group.

Examples

```
awplus# configure terminal
awplus(config)# interface port1.0.1
awplus(config-if)# speed auto 1000
```

To return the port to auto-negotiating its speed, enter the following commands:

```
awplus# configure terminal
awplus(config)# interface port1.0.1
awplus(config-if)# speed auto
```

Related commands

- [duplex](#)
- [polarity](#)
- [show interface](#)
- [speed \(asyn\)](#)

storm-control level

Overview Use this command to specify the speed limiting level for broadcast, multicast, or dlf (destination lookup failure) traffic for the port. Storm-control limits the selected traffic type to the specified percentage of the maximum port speed.

Use the **no** variant of this command to disable storm-control for broadcast, multicast or dlf traffic.

Syntax `storm-control {broadcast|multicast|dlf} level <level>`
`no storm-control {broadcast|multicast|dlf} level`

Parameter	Description
<level>	<0-100> Specifies the percentage of the maximum port speed allowed for broadcast, multicast or destination lookup failure traffic.
broadcast	Applies the storm-control to broadcast frames.
multicast	Applies the storm-control to multicast frames.
dlf	Applies the storm-control to destination lookup failure traffic.

Default Disabled

Mode Interface Configuration

Usage notes Flooding techniques are used to block the forwarding of unnecessary flooded traffic. A packet storm occurs when a large number of broadcast packets are received on a port. Forwarding these packets can cause the network to slow down or time out.

More than one limit type can be set at a time. For example, you can configure both broadcast and multicast levels on the same port, at the same time.

Example To limit broadcast traffic on port1.0.2 to 30% of the maximum port speed, use the following commands:

```
awplus# configure terminal
awplus(config)# interface port1.0.2
awplus(config-if)# storm-control broadcast level 30
```

Related commands [show storm-control](#)

Command changes Version 5.4.9-1.3: Multiple limit types available on x530 series

Version 5.5.0-2.1: Multiple limit types available on x220 and GS980M series

undebbug platform packet

Overview This command applies the functionality of the no `debug platform packet` command.

14

Bridging Commands

Introduction

Overview This chapter provides an alphabetical reference of commands used to configure bridging. For more information, see the [Bridging Feature Overview and Configuration Guide](#).

- Command List**
- “ageing-time” on page 518
 - “bridge” on page 519
 - “bridge-group” on page 520
 - “clear mac-filter counter” on page 522
 - “default-action” on page 523
 - “default-protocol-action” on page 525
 - “l3-filtering enable” on page 526
 - “mac-filter-group egress” on page 527
 - “mac-filter” on page 528
 - “mac-filter-group” on page 529
 - “mac-learning” on page 530
 - “protocol ethii (macfilter)” on page 531
 - “protocol novell (macfilter)” on page 533
 - “protocol sap (macfilter)” on page 535
 - “protocol snap (macfilter)” on page 537
 - “rule (macfilter)” on page 539
 - “rule ip (macfilter)” on page 541
 - “rule ipv6 (macfilter)” on page 543
 - “show bridge” on page 545

- [“show bridge macaddr”](#) on page 547
- [“show mac-filter”](#) on page 548

ageing-time

Overview This command specifies the time period that a learned MAC address will remain defined within the bridge's MAC address table.

Use the **no** variant of this command to set the ageing out time back to the default.

Syntax ageing-time <10-1000000>
no ageing-time

Parameter	Description
<10-1000000>	The number of seconds that the MAC addresses will remain in the table.

Default 300 seconds (5 minutes)

Mode Interface Configuration

Examples To change the ageing time on br2 to 60 seconds (1 minute), use the following commands:

```
awplus#configure terminal
awplus(config)#interface br2
awplus(config-if)#ageing-time 60
```

To reset the ageing time back to its default, use the following commands:

```
awplus#configure terminal
awplus(config-if)#no ageing-time
```

To reset the ageing time back to its default, you can also use the following commands:

```
awplus#configure terminal
awplus(config-if)#ageing-time 300
```

Output None

Related commands [bridge](#)
[bridge-group](#)
[show bridge](#)
[show bridge macaddr](#)

bridge

Overview Use this command to create a software bridge.
Use the **no** variant of this command to remove the specified bridge.

Syntax `bridge <bridge-id>`
`no bridge <bridge-id>`

Parameter	Description
<code><bridge-id></code>	The bridge ID (from 1 to 255). This is made up of the bridge priority and the bridge's MAC address.

Default No configured bridges

Mode Global Configuration

Usage notes The bridge interface name will be prefixed with 'br' followed by the bridge ID.
*If interfaces exist on a bridge, then the bridge cannot be removed. For example if interface eth1 exists on bridge 2, then the **no bridge 2** command will give you the following message:*

```
% failed to remove interface br2, there are still configured sub-interfaces.
```

Example To create a bridge with the ID of 2, use the following commands:

```
awplus#configure terminal  
awplus(config)#bridge 2
```

To remove the bridge with the ID of 2, use the following commands:

```
awplus#configure terminal  
awplus(config)##no bridge 2
```

Related commands

- [ageing-time](#)
- [bridge-group](#)
- [show bridge](#)
- [show bridge macaddr](#)

bridge-group

Overview Use this command to add an interface to a bridge. Interfaces that have been added to a bridge will lose their L3 properties.

Use the **no** variant of this command to remove an interface from a bridge.

Syntax `bridge-group <0-255> [port-protected]`
`no bridge-group`

Parameter	Description
<0-255>	The ID of the bridge that you are adding the interface to. Interface ID 0 is a VLAN-aware bridge. For more information about the VLAN-aware bridge, see the Bridging Feature Overview and Configuration Guide .
port-protected	Interfaces added to a bridge can be added in “protected” mode. Interfaces in this mode that are part of the same bridge-group will be unable to bridge to each other, but communication with unprotected interfaces will be unimpeded. Omitting this option from the command will add the interface in unprotected mode.

Default An interface is not part of any bridge by default

Mode Interface Configuration

Usage notes Interfaces can only be part of one bridge, so when removing the bridge no parameters are required.

Interfaces that have been added to a bridge will lose their Layer 3 properties. The bridge will act as the Layer 3 interface. The bridge will provide Layer 2 connectivity between interfaces that are a part of the same bridge-group.

You can attach interfaces such as Ethernet, VLAN, VTI (Tunnel) to your bridge.

Examples To add eth1 to bridge 2 in unprotected mode, use the following commands:

```
awplus# configure terminal
awplus(config)# interface eth1
awplus(config-if)# bridge-group 2
```

To add eth1 to bridge 2 in protected mode, use the following commands:

```
awplus# configure terminal
awplus(config)# interface eth1
awplus(config-if)# bridge-group 2 port-protected
```

To remove eth1 from bridge 2, use the following commands:

```
awplus# configure terminal
awplus(config)# interface eth1
awplus(config-if)# no bridge-group
```

**Related
commands**

ageing-time
bridge
show bridge
show bridge macaddr

clear mac-filter counter

Overview This command clears all the mac-filter counters on a bridge interface.

Syntax

```
clear mac-filter counter  
clear mac-filter counter ingress  
clear mac-filter counter egress  
clear mac-filter counter {ingress|egress} <interface-name>
```

Parameter	Description
ingress	Clear only the ingress counters
egress	Clear only the egress counters
<interface-name>	Clear counters on the specified interface

Default None

Mode Privileged Exec

Examples To clear all ingress counters on eth1, use the following command:

```
awplus#clear mac-filter counter ingress eth1
```

To clear all ingress counters, use the following command:

```
awplus#clear mac-filter counter ingress
```

To clear all mac-filter counters, use the following command:

```
awplus#clear mac-filter counter
```

Related commands

- [mac-filter](#)
- [mac-filter-group](#)
- [show mac-filter](#)
- [rule \(macfilter\)](#)

Command changes Version 5.4.8-0.2: command updated

default-action

Overview Use this command to set the default action for packets not hitting a particular mac-filter.

Use the **no** variant of this command to remove the configured default action. See the third example below for more information.

Syntax `default-action [permit|deny|none]`
`no default-action`

Parameter	Description
permit	Accept the traffic which didn't match any rule in the mac-filter. This means the traffic will not pass through any other mac-filters.
deny	Drop the traffic which didn't hit any rule in the mac-filter.
none	Allow the traffic (which didn't hit any rule in the mac-filter) to traverse the next mac-filter, if any are configured.

Default Deny.

Mode MAC Filter Configuration

Example 1 To set the default action to **none** for the mac-filter named: filter1, use the following commands:

```
awplus# configure terminal
awplus(config)# mac-filter filter1
awplus(config-macfilter)# default-action none
```

This means that if this filter is set on ingress traffic for eth1 and that traffic doesn't hit any rules in the filter, then the traffic will progress to any other filters present. For example, there could be a filter on bridge1 that eth1 is a part of. If bridge1 also has mac filters, then those filters have a chance to examine that traffic ingressing eth1.

Example 2 To set the default action to **permit** for the mac-filter named: filter1, use the following commands:

```
awplus# configure terminal
awplus(config)# mac-filter filter1
awplus(config-macfilter)# default-action permit
```

This means that if this filter is set on ingress traffic for eth1 and that traffic doesn't hit any rules in the filter, then the traffic will not progress to any other filters present, and will not undergo any more filtering.

Example 3 To set the default action to **deny** for the mac-filter named: filter1, use the following commands:

```
awplus# configure terminal
awplus(config)# mac-filter filter1
awplus(config-macfilter)# default-action deny
```

This means that if this filter is set on ingress traffic for eth1 and that traffic doesn't hit any rules in the filter, then the traffic will be dropped. This is the same as setting the command **no default-action**.

Related commands [mac-filter](#)

Command changes Version 5.4.7-2.1: command added

default-protocol-action

Overview Use this command to set the default behavior (permit or deny) when a packet does not match any configured protocol filter. Permit means to continue to the rules (if rules exist). If there are no rules or no rules match, then continue to the default action.

Use the **no** variant of this command to revert to the default filtering action of 'permit'.

Syntax `default-protocol-action {permit|deny}`
`no default-protocol-action`

Parameter	Description
permit	Allow the packet
deny	Drop the packet

Default Permit.

Mode MAC Filter Configuration

Example To designate ATL-router1 to deny all packets that do not match the configured protocol filters, use the following commands:

```
awplus# configure terminal
awplus(config)# mac-filter ATL-router1
awplus(config-macfilter)# default-protocol-action deny
```

Related commands [protocol ethii \(macfilter\)](#)
[protocol novell \(macfilter\)](#)
[protocol sap \(macfilter\)](#)
[protocol snap \(macfilter\)](#)

Command changes Version 5.4.8-0.2: command added

I3-filtering enable

Overview Use this command to enable traffic control for bridged traffic on a bridge interface.

Use the **no** variant of this command to disable traffic control for bridged traffic on a bridge interface.

Syntax l3-filtering enable
no l3-filtering enable

Default Traffic control is disabled by default for bridged traffic.

Mode Interface mode for a bridge interface

Example To enable traffic control for bridged traffic on br1, use the commands:

```
awplus# configure terminal
awplus(config)# interface br1
awplus(config-if)# l3-filtering enable
```

Related commands [traffic-control](#)

Command changes Version 5.4.7-0.1: command added. Previously, traffic control was enabled by default on all bridge interfaces.

mac-filter-group egress

Overview Use this command to apply an egress MAC-filter to a bridge interface, bridge port, or potential bridge port.

Use the **no** variant of this command to remove an egress MAC-filter on a specific bridge interface or bridge port.

Syntax `mac-filter-group egress <mac-filter-name>`
`no mac-filter-group egress`

Parameter	Description
<code><mac-filter-name></code>	The name of the MAC-filter that is applied to the bridge interface or bridge port on egress.

Default No mac-filter.

Mode Interface Configuration

Example To configure MAC-filter 'filter1' to operate on traffic egressing tunnel2, use the following commands:

```
awplus# configure terminal
awplus(config)# int tunnel2
awplus(config-if)# mac-filter-group egress filter1
```

To remove that same filter, use the following commands:

```
awplus# configure terminal
awplus(config)# int tunnel2
awplus(config-if)# no mac-filter-group egress
```

Related commands [mac-filter](#)
[show mac-filter](#)
[clear mac-filter counter](#)

Command changes Version 5.4.8-0.2 command updated.

mac-filter

Overview This command creates a Layer 2 MAC filter that can be applied on a bridge. Use the **no** variant of this command to remove the MAC filter.

Syntax `mac-filter [<mac-filter-name>]`
`no mac-filter [<mac-filter-name>]`

Parameter	Description
<mac-filter-name>	The name of the mac-filter (maximum of 16 characters).

Default None

Mode Interface Configuration

Usage notes You can only create one MAC filter at one time.

Examples To create a mac-filter with the name of ATL-router1, use the following commands:

```
awplus#configure terminal  
awplus(config)#mac-filter ATL-router1
```

To delete a mac-filter, use the following commands:

```
awplus#configure terminal  
awplus(config)#no mac-filter ATL-router1
```

Output None

Related commands [clear mac-filter counter](#)
[mac-filter-group](#)
[show mac-filter](#)

mac-filter-group

Overview This command applies a Layer two MAC filter on a bridge.
Use the **no** variant of this command to remove the mac-filter on a bridge.

Syntax `mac-filter-group [<mac-filter-name>]`
`no mac-filter-group`

Parameter	Description
<code><mac-filter-name></code>	The name of the mac-filter (maximum 16 characters).

Default None

Mode Interface Configuration

Usage notes You can only apply one MAC filter at one time.

Examples To apply a mac-filter with the name of ATL-router1 on bridge interface br1, use the following commands:

```
awplus#configure terminal
awplus(config)#interface br1
awplus(config-if)#mac-filter-group ATL-router1
```

To remove the mac-filter on a bridge, use the following commands:

```
awplus#configure terminal
awplus(config)#interface br1
awplus(config-if)#no mac-filter-group
```

Output Figure 14-1: Example output from the **mac-filter-group** command displaying information about all bridges:

```
mac-filter "ATL-router1" will be applied to the bridge interface
br1
```

Related commands

- [clear mac-filter counter](#)
- [mac-filter](#)
- [show mac-filter](#)

mac-learning

Overview Use this command to enable FDB MAC address learning on a bridge interface. In some circumstances, FDB MAC address learning on a software-based router bridge is not useful, and it is better to flood the traffic within interfaces associated with the bridge instance, to ensure the traffic reaches its destination.

Use the **no** variant of this command to disable or enable FDB MAC address learning on a bridge.

Syntax `mac-learning`
`no mac-learning`

Default Learning is enabled by default.

Mode Interface mode for a bridge interface

Example To turn off learning on bridge 2, use the following commands:

```
awplus# configure terminal
awplus(config)# interface br2
awplus(config-if)# no mac-learning
```

To turn learning on bridge 2 back on, use the following commands:

```
awplus# configure terminal
awplus(config)# interface br2
awplus(config-if)# mac-learning
```

Command changes Version 5.4.7-0.1: command added

protocol ethii (macfilter)

Overview Use this command to add a bridge protocol filter for Ethernet II packets. If ether-type is not specified, then all Ethernet II packets match the rule.

If ether-type is specified, then only packets having the specified ether-type matches the rule.

Use the **no** variant of this command to remove the protocol filter.

Syntax

```
protocol <filter-name> {permit|deny} ethii
protocol <filter-name> {permit|deny} ethii ether-type
<ether-type>
protocol <filter-name> {permit|deny} ethii {after|before}
protocol <filter-name>
protocol <filter-name> {permit|deny} ethii ether-type
<ether-type> {after|before} protocol <filter-name>
no protocol <filter-name>
```

Parameter	Description
<filter-name>	Protocol filter name.
permit	Allow the matched frame
deny	Drop the matched frame
ethii	Ethernet type II frame
ether-type	Ethertype of Ethernet II frame
<ether-type>	Ethertype (2 bytes in hexadecimal, e.g. 0800) or any of the well-known names..
arp	ARP (Address Resolution Protocol), 0806
atmf	ATMF (Allied Telesis Management Framework), fbae
atmf-agent	ATMF Agent, fbae
ip	IPv4 (Internet Protocol version 4), 0800
ipv6	IPv6 (Internet Protocol version 6), 86dd
loop	Loopback (Ethernet Configuration Testing Protocol), 9000
ppp	PPP (Point-to-Point Protocol), 880b
pppoe-disc	PPPoE Discovery, 8863
pppoe-sess	PPPoE Session, 8864
after	Add after the following protocol filter name
before	Add before the following protocol filter name.

Default The default action is permit.

Mode MAC Filter Configuration

Usage notes This command adds or deletes a protocol filter for bridged traffic in Mac filter mode.

By default all protocols are permitted, but this can be changed by using the command: **default-protocol-action**.

This command, examines packets for each protocol filter in the configured order.

- If a denied protocol filter is matched, then the packet is immediately dropped without examining the rest of protocol filters and rules
- If a permitted protocol filter is matched, then the packet skips the rest of protocol filters and continues to examine rules.

Example To allow all IPv4 packets, use the commands:

```
awplus# configure terminal
awplus(config)# mac-filter ATL-router1
awplus(config-macfilter)# protocol 1 permit ethii ether-type ip
```

Related commands

- [rule \(macfilter\)](#)
- [rule ip \(macfilter\)](#)
- [rule ipv6 \(macfilter\)](#)
- [default-protocol-action](#)
- [show mac-filter](#)
- [clear mac-filter counter](#)

Command changes Version 5.4.8-0.2: command added

protocol novell (macfilter)

Overview Use this command to add a bridge protocol filter for Novell raw IEEE 802.3 packets..
Use the **no** variant of this command to remove the protocol filter.

Syntax

```
protocol <filter-name> {permit|deny} novell  
protocol <filter-name> {permit|deny} novell {after|before}  
protocol <filter-name>  
  
no protocol <filter-name>
```

Parameter	Description
<filter-name>	Protocol filter name.
permit	Allow the matched frame
deny	Drop the matched frame
novell	Novell raw IEEE 802.3
after	Add after the following protocol filter name
before	Add before the following protocol filter name.

Default The default action is permit.

Mode MAC Filter Configuration

Usage notes This command adds or deletes a protocol filter for bridged traffic in Mac filter mode.

By default all protocols are permitted, but this can be changed by using the command: **default-protocol-action**.

This command, examines packets for each protocol filter in the configured order.

- If a denied protocol filter is matched, then the packet is immediately dropped without examining the rest of protocol filters and rules
- If a permitted protocol filter is matched, then the packet skips the rest of protocol filters and continues to examine rules.

Example To allow all Novell IEEE 802.3 packets, use the commands:

```
awplus# configure terminal  
awplus(config)# mac-filter ATL-router1  
awplus(config-macfilter)# protcol 1 permit novell
```

Related commands

- [rule \(macfilter\)](#)
- [rule ip \(macfilter\)](#)
- [rule ipv6 \(macfilter\)](#)

default-protocol-action

show mac-filter

clear mac-filter counter

Command changes Version 5.4.8-0.2: command added

protocol sap (macfilter)

Overview Use this command to add a bridge protocol filter for IEEE 802.3 packets. If `sap-type` is not specified, then all IEEE 802.3 packets (including Novell raw IEEE 802.3, IEEE 802.3 with 802.2 LLC and IEEE 802.3 with 802.2 SNAP) match the rule.

If `sap-type` is specified, then only packets having the specified `sap-type` matches the rule.

Use the **no** variant of this command to remove the protocol filter.

Syntax

```
protocol <filter-name> {permit|deny} sap
protocol <filter-name> {permit|deny} sap sap-type <sap-type>
protocol <filter-name> {permit|deny} sap {after|before}
protocol <filter-name>
protocol <filter-name> {permit|deny} sap sap-type <sap-type>
{after|before} protocol <filter-name>
no protocol <filter-name>
```

Parameter	Description
<filter-name>	Protocol filter name.
permit	Allow the matched frame
deny	Drop the matched frame
sap	SAP (IEEE 802.3)
sap-type	SAP type
<sap-type>	SAP type value (1 byte in hexadecimal, e.g. e0)
after	Add after the following protocol filter name
before	Add before the following protocol filter name.

Default The default action is permit. You can change the default by using the command: **default-protocol-action**.

Mode MAC Filter Configuration

Usage notes This command adds or deletes a protocol filter for bridged traffic in Mac filter mode.

This command, examines packets for each protocol filter in the configured order.

- If a denied protocol filter is matched, then the packet is immediately dropped without examining the rest of protocol filters and rules
- If a permitted protocol filter is matched, then the packet skips the rest of protocol filters and continues to examine rules.

Example To allow Novell Netware SAP type of 802.2 packets, use the commands:

```
awplus# configure terminal
awplus(config)# mac-filter ATL-router1
awplus(config-macfilter)# protocol 2 permit sap sap-type e0
```

**Related
commands**

rule (macfilter)
rule ip (macfilter)
rule ipv6 (macfilter)
default-protocol-action
show mac-filter
clear mac-filter counter

**Command
changes**

Version 5.4.8-0.2: command added

protocol snap (macfilter)

Overview Use this command to add a bridge protocol filter for SNAP (IEEE 802.3 with 802.2 SNAP) packets. If snap-type is not specified, then all snap packets match the rule.

If snap-type is specified, then only packets having the specified snap-type matches the rule.

Use the **no** variant of this command to remove the protocol filter.

Syntax

```
protocol <filter-name> {permit|deny} snap
protocol <filter-name> {permit|deny} snap-type <snap-type>
protocol <filter-name> {permit|deny} snap {after|before}
protocol <filter-name>
protocol <filter-name> {permit|deny} snap snap-type <snap-type>
{after|before} protocol <filter-name>
no protocol <filter-name>
```

Parameter	Description
<filter-name>	Protocol filter name.
permit	Allow the matched frame
deny	Drop the matched frame
snap	IEEE 802.2 SNAP
snap-type	SNAP type
<snap-type>	SNAP protocol ID (2 bytes in hexadecimal, e.g. 0800)
after	Add after the following protocol filter name
before	Add before the following protocol filter name.

Default The default action is permit.

Mode MAC Filter Configuration

Usage notes This command adds or deletes a protocol filter for bridged traffic in Mac filter mode.

By default all protocols are permitted, but this can be changed by using the command: **default-protocol-action**.

This command, examines packets for each protocol filter in the configured order.

- If a denied protocol filter is matched, then the packet is immediately dropped without examining the rest of protocol filters and rules
- If a permitted protocol filter is matched, then the packet skips the rest of protocol filters and continues to examine rules.

Example To allow all SNAP packets, use the commands:

```
awplus# configure terminal
awplus(config)# mac-filter ATL-router1
awplus(config-macfilter)# protocol 3 permit snap
```

**Related
commands**

rule (macfilter)
rule ip (macfilter)
rule ipv6 (macfilter)
default-protocol-action
show mac-filter
clear mac-filter counter

**Command
changes**

Version 5.4.8-0.2: command added

rule (macfilter)

Overview Use this command to add a filter rule to a specified mac-filter. The filter rule can also be configured to run after or before the specified rule.

Use the **no** variant of this command to remove a filter rule.

Syntax

```
rule <rule-name> {deny|permit} [dmac {<mac-addr>|any}] [smac {<mac-addr>|any}] [proto {<ether-type>|any}] [offset <0-1499> hex-string <match-string>] [{after|before} rule <rule-name>]  
no rule <rule-name>
```

Parameter	Description
<rule-name>	The name of the rule (maximum of 16 characters)
deny	Drop the matched frame
permit	Allow the matched frame
dmac	Destination MAC address
smac	Source MAC address
<mac-addr>	MAC address in HHHH.HHHH.HHHH format
<ether-type>	Ethernet protocol type
offset	Offset of Ethernet data to match
<0-1499>	Offset value (0 is the beginning of the Ethernet data)
hex-string	Match with the specified hexadecimal string
<match-string>	String to match in hexadecimal (e.g. 01ab)
after	Add after the following rule name
before	Add before the following rule name
rule <rule-name>	Mac Filter rule

Mode MAC Filter Configuration

Usage notes The filter rule can specify any combination of the following:

- destination MAC address
- source MAC address
- Ethernet protocol type
- string match from a specific offset of Ethernet data

Example To configure a bridge filter rule (RULE1) that permits any destination MAC address with the source address of 00c4.6d20.c0f4 with any protocol, use the following commands:

```
awplus# configure terminal
awplus(config)# mac-filter ATL-router1
awplus(config-macfilter)# rule RULE1 permit dmac any smac
00c4.6d20.c0f4 proto any
```

Example To configure a bridge filter rule (RULE2) that permits any broadcast traffic with 0xF2 at the offset of 28 (29th byte) in the Ethernet data, use the following commands:

```
awplus# configure terminal
awplus(config)# mac-filter ATL-router1
awplus(config-macfilter)# rule RULE2 permit dmac ffff.fff.ffff
offset 28 hex-string f2
```

Related commands

- [show mac-filter](#)
- [clear mac-filter counter](#)
- [rule ip \(macfilter\)](#)
- [rule ipv6 \(macfilter\)](#)

Command changes Version 5.4.8-0.2: command added

rule ip (macfilter)

Overview Use this command to add a bridge filter rule based on the IP protocol.

Use the **no** variant of this command to remove a bridge IP protocol filter.

Syntax

```
rule <name> {deny|permit} ip [src {<ip-addr>|<ip-subnet>}]  
[dst {<ip-addr>|<ip-subnet>}] [proto <1-255>] [{after|before}  
rule <name>]  
  
rule <name> {deny|permit} ip [src {<ip-addr>|<ip-subnet>}]  
[dst {<ip-addr>|<ip-subnet>}] [proto {tcp|udp} [sport  
<1-65535>] [dport <1-65535>]] [{after|before} rule <name>]  
  
no rule <name>
```

Parameter	Description
<name>	Rule name
deny	Drop the matched frame
permit	Permit the matched frame
src <ip-addr>	Source IP address
src <ip-subnet>	Source IP address with subnet prefix length
dst <ip-addr>	Destination IP address
dst <ip-subnet>	Destination IP address with subnet prefix length
proto <1-255>	IP protocol number
proto tcp	TCP protocol
proto udp	UDP protocol
sport <1-65535>	TCP or UDP source port number
dport <1-65535>	TCP or UDP destination port number
after	Add after the following rule name
before	Add before the following rule name
rule <name>	MAC Filter rule name

Mode MAC Filter Configuration

Example To add a bridge filter rule that permits IP packets with a source address of 192.168.1.1 and a destination address of 10.0.0.0/8 using the TCP protocol to destination port 23, use the following commands:

```
awplus# configure terminal  
awplus(config)# mac-filter ATL-router1  
awplus(config-macfilter)# rule 1 permit ip scr 192.168.1.1 dst  
10.0.0.0/8 proto tcp dport 23
```

Related commands show mac-filter
rule (macfilter)
default-protocol-action

Command changes Version 5.4.8-0.2: command added

rule ipv6 (macfilter)

Overview Use this command to add a bridge filter rule based on the IPv6 protocol.
Use the **no** variant of this command to remove a bridge IPv6 protocol filter.

Syntax

```
rule <name> {deny|permit} ipv6 [src
{<ipv6-addr>|<ipv6-addr/prefix-length>}]
[dst {<ipv6-addr>|<ipv6-addr/prefix-length>}] [proto <1-255>]
[after|before] rule <name>]

rule <name> {deny|permit} ipv6 [src
{<ipv6-addr>|<ipv6-addr/prefix-length>}]
[dst {<ipv6-addr>|<ipv6-addr/prefix-length>}] [proto {tcp|udp}
[sport <1-65535>] [dport <1-65535>]] [{after|before} rule
<name>]

no rule <name>
```

Parameter	Description
<name>	Rule name
deny	Drop the matched frame
permit	Permit the matched frame
src <ipv6-addr>	Source IPv6 address
src <ipv6-addr/prefix-length>	Source IPv6 address with subnet prefix length
dst <ipv6-addr>	Destination IPv6 address
dst <ipv6-addr/prefix-length>	Destination IPv6 address with subnet prefix length
proto <1-255>	IPv6 protocol number
proto tcp	TCP protocol
proto udp	UDP protocol
sport <1-65535>	TCP or UDP source port number
dport <1-65535>	TCP or UDP destination port number
after	Add after the following rule name
before	Add before the following rule name
rule <name>	MAC Filter rule name

Mode MAC Filter Configuration

Example To add a bridge filter rule that permits IPv6 packets with a source address of 2001::1 and a destination address of 3001::/64 using the TCP protocol to destination port 23, use the following commands:

```
awplus# configure terminal
awplus(config)# mac-filter ATL-router1
awplus(config-macfilter)# rule 1 permit ipv6 scr 2001::1 dst
3001::/64 proto tcp dport 23
```

Related commands [show mac-filter rule \(macfilter\)](#)
[protocol sap \(macfilter\)](#)

Command changes Version 5.4.8-0.2: command added

show bridge

Syntax Use this command to display detailed information about your bridge(s).

Syntax `show bridge [<bridge-list>]`

Parameter	Description
<bridge-list>	The bridge/s to display the information about. The <bridge-list> can be: <ul style="list-style-type: none">• a single bridge(e.g. br2)• a continuous range of bridges (e.g. br1-3)• a comma separated list of bridges and/or ranges (e.g. br1,br2,br3-br5)

Default Displays detailed information about all bridges, if no <bridge-list> is specified.

Mode Privileged Exec

Examples To display information about all bridges, use the following command:

```
awplus#show bridge
```

To display information about bridge 2, use the following command:

```
awplus#show bridge br2
```

To display information about bridge in the range 1 to 3, use the following command:

```
awplus#show bridge br1-3
```

To display information about bridges 1, and from 3 to 5, use the following command:

```
awplus#show bridge br1,br3-5
```

Output Figure 14-2: Example output from the **show bridge** command displaying information about all bridges:

```
awplus#show bridge
Bridge Name      Aging Timer      Interfaces
-----
br1              300              eth1
br3              300
br4              300
br5              300
```

Figure 14-3: Example output from the **show bridge** command displaying information about bridge 1.

```
awplus#show bridge br1
Bridge Name      Aging Timer      Interfaces
-----
br1              300              eth1
```

**Related
commands**

- [ageing-time](#)
- [bridge](#)
- [bridge-group](#)
- [show bridge macaddr](#)

show bridge macaddr

Overview Use this command to display the MAC entries learned in the MAC table for your bridge.

Syntax `show bridge macaddr <bridge-list>`

Parameter	Description
<code><bridge-list></code>	The bridge interfaces to display the information about. The <code><bridge-list></code> can be: <ul style="list-style-type: none">• a single bridge (e.g. br2)• a continuous range of bridges (e.g. br1-3)• a comma separated list of bridges and/or ranges (e.g. br1,br2,br3-br5)

Mode Global Configuration

Example To display the learned MAC entries for bridge 2, use the following commands:

```
awplus# configure terminal
awplus(config)# show bridge macaddr br2
```

Output Figure 14-4: Example output from the **show bridge macaddr** command displaying information about bridge 2:

```
awplus#show bridge macaddr br2
```

Bridge Name	Interface	mac addr	is local?	ageing
br2	vlan1	ec:cd:6d:20:c0:fb	no	41
br2	vlan1	00:c4:6d:20:c0:e6	no	0
br2	vlan1	ec:cd:6d:20:c0:bd	yes	0
...				

Related commands

- [ageing-time](#)
- [bridge](#)
- [bridge-group](#)
- [show bridge](#)

show mac-filter

Overview This command displays configured protocol filters and rules along with packet and byte counts on a bridge or an interface that is a member of a bridge.

Syntax `show mac-filter [<interface-name>]`

Parameter	Description
<interface-name>	The interface name. Mac-filters applied to this interface will be displayed.

Default Displays all MAC filters, rules, and counters for all interfaces on a bridge.

Mode Privileged Exec

Examples To display all MAC filters, rules, and counters for all interfaces on a bridge, use the following command:

```
awplus#show mac-filter
```

Output Figure 14-5: Example output from **show mac-filter**

```
awplus#show mac-filter
```

Iface	Rule	Options	Pkt Count
	Dir / Action		Byte Count
br1	a	Protocol : Ethernet II	0
	in / deny	Ether-type : ip	0
br1		Protocol (default action)	0
	in / permit		0
br1		Rule (default action)	0
	in / permit		0
vlan1	1	IPv4 Src : any	0
	out / deny	Dst : 192.168.1.20	0
		Proto: any	
vlan1	2	IPv6 Src : any	0
	out / deny	Dst : 2001::20	0
		Proto: any	
vlan1	20	DMAC : any	0
	out / permit	SMAC : any	0
		Proto : 0x0800	
vlan1	30	DMAC : any	
	out / permit	SMAC : any	0
		Proto : any	0
		Offset: 10	
		String: 010203abcd	
vlan1		Rule (default action)	0
	out / deny		0

Related commands [mac-filter](#)

mac-filter-group

Command changes Version 5.4.8-0.2: command updated

15

VLAN Commands

Introduction

Overview This chapter provides an alphabetical reference of commands used to configure VLANs. For more information see the [VLAN Feature Overview and Configuration Guide](#).

- Command List**
- “[show vlan](#)” on page 551
 - “[switchport access vlan](#)” on page 552
 - “[switchport mode access](#)” on page 553
 - “[switchport mode trunk](#)” on page 554
 - “[switchport trunk allowed vlan](#)” on page 555
 - “[switchport trunk native vlan](#)” on page 558
 - “[switchport voice dscp](#)” on page 559
 - “[switchport voice vlan](#)” on page 560
 - “[switchport voice vlan priority](#)” on page 562
 - “[vlan](#)” on page 563
 - “[vlan database](#)” on page 565

show vlan

Overview Use this command to display information about a particular VLAN by specifying its VLAN ID. Selecting **all** will display information for all the VLANs configured.

Syntax `show vlan`
{all|brief|dynamic|static|auto|static-ports|<1-4094>}

Parameter	Description
<1-4094>	Display information about the VLAN specified by the VLAN ID.
all	Display information about all VLANs on the device.
brief	Display information about all VLANs on the device.
dynamic	Display information about all VLANs learned dynamically.
static	Display information about all statically configured VLANs.
auto	Display information about all auto-configured VLANs.
static-ports	Display static egress/forbidden ports.

Mode User Exec and Privileged Exec

Example To display information about VLAN 2, use the command:

```
awplus# show vlan 2
```

Output Figure 15-1: Example output from the **show vlan** command

VLAN ID	Name	Type	State	Member ports
				(u)-Untagged, (t)-Tagged
2	VLAN0002	STATIC	ACTIVE	port1.0.3(u) port1.0.4(u) port1.0.5(u) port1.0.6(u)
...				

Related commands [vlan](#)

Command changes Version 5.5.0-1.3: Support for up to 5 VLANs added to AR1050V

switchport access vlan

Overview Use this command to change the port-based VLAN of the current port.
Use the **no** variant of this command to change the port-based VLAN of this port to the default VLAN, VLAN 1.

Syntax `switchport access vlan <vlan-id>`
`no switchport access vlan`

Parameter	Description
<vlan-id>	<1-4094> The port-based VLAN ID for the port.

Default VLAN 1

Mode Interface Configuration

Usage notes Any untagged frame received on this port will be associated with the specified VLAN.

Examples To change the port-based VLAN to VLAN 3 for port1.0.2, use the commands:

```
awplus# configure terminal
awplus(config)# interface port1.0.2
awplus(config-if)# switchport access vlan 3
```

To reset the port-based VLAN to the default VLAN 1 for port1.0.2, use the commands:

```
awplus# configure terminal
awplus(config)# interface port1.0.2
awplus(config-if)# no switchport access vlan
```

Related commands [show interface switchport](#)
[show vlan](#)

Command changes Version 5.5.0-1.3: Support for up to 5 VLANs added to AR1050V

switchport mode access

Overview Use this command to set the switching characteristics of the port to access mode. Received frames are classified based on the VLAN characteristics, then accepted or discarded based on the specified filtering criteria.

Syntax `switchport mode access [ingress-filter {enable|disable}]`

Parameter	Description
<code>ingress-filter</code>	Set the ingress filtering for the received frames.
<code>enable</code>	Turn on ingress filtering for received frames. This is the default.
<code>disable</code>	Turn off ingress filtering to accept frames that do not meet the classification criteria.

Default By default, ports are in access mode with ingress filtering on.

Usage notes Use access mode to send untagged frames only.

Mode Interface Configuration

Example

```
awplus# configure terminal
awplus(config)# interface port1.0.2
awplus(config-if)# switchport mode access ingress-filter enable
```

Related Commands [show interface switchport](#)

Command changes Version 5.5.0-1.3: Support for up to 5 VLANs added to AR1050V

switchport mode trunk

Overview Use this command to set the switching characteristics of the port to trunk. Received frames are classified based on the VLAN characteristics, then accepted or discarded based on the specified filtering criteria.

Syntax `switchport mode trunk [ingress-filter {enable|disable}]`

Parameter	Description
<code>ingress-filter</code>	Set the ingress filtering for the frames received.
<code>enable</code>	Turn on ingress filtering for received frames. This is the default.
<code>disable</code>	Turn off ingress filtering to accept frames that do not meet the classification criteria.

Default By default, ports are in access mode, are untagged members of the default VLAN (VLAN 1), and have ingress filtering on.

Mode Interface Configuration

Usage notes A port in trunk mode can be a tagged member of multiple VLANs, and an untagged member of one native VLAN.

To configure which VLANs this port will trunk for, use the [switchport trunk allowed vlan](#) command.

Example

```
awplus# configure terminal
awplus(config)# interface port1.0.3
awplus(config-if)# switchport mode trunk ingress-filter enable
```

Related Commands [show interface switchport](#)

Command changes Version 5.5.0-1.3: Support for up to 5 VLANs added to AR1050V

switchport trunk allowed vlan

Overview Use this command to add VLANs to be trunked over this switch port. Traffic for these VLANs can be sent and received on the port.

Use the **no** variant of this command to reset switching characteristics of a specified interface to negate a trunked configuration specified with **switchport trunk allowed vlan** command.

Syntax

```
switchport trunk allowed vlan all
switchport trunk allowed vlan none
switchport trunk allowed vlan add <vid-list>
switchport trunk allowed vlan remove <vid-list>
switchport trunk allowed vlan except <vid-list>
no switchport trunk
```

Parameter	Description
all	Allow all VLANs to transmit and receive through the port.
none	Allow no VLANs to transmit and receive through the port.
add	Add a VLAN to the list of VLANs that are allowed to transmit and receive through the port. Only use this parameter if a list of VLANs is already configured on a port.
remove	Remove a VLAN from the list of VLANs that are allowed to transmit and receive through the port. Only use this parameter if a list of VLANs is already configured on a port. If you are removing VLAN port membership for a large number of switchports and VLANs, note that this command may take a number of minutes to run.
except	All VLANs, except the VLAN for which the VID is specified, are part of its port member set. Only use this parameter to remove VLANs after either this parameter or the all parameter have added VLANs to a port.
<vid-list>	<2-4094> The ID of the VLAN or VLANs that will be added to, or removed from, the port. A single VLAN, VLAN range, or comma-separated VLAN list can be set. For a VLAN range, specify two VLAN numbers: lowest, then highest number in the range, separated by a hyphen. For a VLAN list, specify the VLAN numbers separated by commas. Do not enter spaces between hyphens or commas when setting parameters for VLAN ranges or lists.

Default By default, ports are untagged members of the default VLAN (VLAN 1).

Mode Interface Configuration

Usage notes The **all** parameter sets the port to be a tagged member of all the VLANs configured on the device. The **none** parameter removes all VLANs from the port's tagged member set. The **add** and **remove** parameters will add and remove VLANs to and from the port's member set. The **except** parameter creates an exception to the list.

If you use the **all** parameter, and then you want to remove VLANs from the port's member list, you must use the **except** parameter to remove the unwanted VLANs. Similarly, if you use the **except** parameter to remove a list of VLANs, and you want to change that list, you must use the **except** parameter to make that change (not the **add** and **remove** parameters).

For example, if you want to remove VLAN3-5 from a port and the port's configuration is currently **switchport trunk allowed vlan all**, then you should remove VLAN3-5 by entering the **except** parameter, instead of using the **remove** parameter. This means using the following commands:

```
awplus# configure terminal
awplus(config)# interface port1.0.6
awplus(config-if)# switchport trunk allowed vlan except 3-5
```

If you do this, then the configuration changes to:

```
awplus#show running-config
interface port1.0.6
switchport
switchport mode trunk
switchport trunk allowed vlan except 3-5
```

For example, if you want to add VLAN4 back in again, and the port configuration is currently **switchport trunk allowed vlan except 3-5**, then you should add VLAN4 by re-entering the **except** parameter with the list of VLANs to remove, instead of using the **add** parameter. This means using the following commands:

```
awplus# configure terminal
awplus(config)# interface port1.0.6
awplus(config-if)# switchport trunk allowed vlan except 3,5
```

If you do this, then the configuration changes to:

```
awplus#show running-config
interface port1.0.6
switchport
switchport mode trunk
switchport trunk allowed vlan except 3,5
```

Examples The following shows adding a single VLAN to a port's member set.

```
awplus# configure terminal
awplus(config)# interface port1.0.2
awplus(config-if)# switchport trunk allowed vlan add 2
```

The following shows adding a range of VLANs to a port's member set.

```
awplus# configure terminal
awplus(config)# interface port1.0.2
awplus(config-if)# switchport trunk allowed vlan add 2-4
```

The following shows adding a list of VLANs to a port's member set.

```
awplus# configure terminal
awplus(config)# interface port1.0.2
awplus(config-if)# switchport trunk allowed vlan add 2,3,4
```

**Command
changes**

Version 5.5.0-1.3: Support for up to 5 VLANs added to AR1050V

switchport trunk native vlan

Overview Use this command to configure the native VLAN for this port. The native VLAN is used for classifying the incoming untagged packets. Use the **none** parameter with this command to remove the native VLAN from the port and set the acceptable frame types to VLAN-tagged only.

Use the **no** variant of this command to reset the native VLAN to the default VLAN ID 1 and remove tagged VLANs from the port.

Syntax `switchport trunk native vlan {<vid>|none}`
`no switchport trunk native vlan`

Parameter	Description
<vid>	The ID of the VLAN that will be used to classify the incoming untagged packets, in the range 2-2094. The VLAN ID must be a part of the VLAN member set of the port.
none	No native VLAN specified. This option removes the native VLAN from the port and sets the acceptable frame types to vlan-tagged only. Note: Use the no variant of this command to revert to the default VLAN 1 as the native VLAN for the specified interface switchport - not none .

Default VLAN 1 (the default VLAN), which is reverted to using the **no** form of this command.

Mode Interface Configuration

Examples To set the native VLAN on interface port1.0.2 to VLAN 2, use the commands:

```
awplus# configure terminal
awplus(config)# interface port1.0.2
awplus(config-if)# switchport trunk native vlan 2
```

To remove the native VLAN from interface port1.0.2, use the commands:

```
awplus# configure terminal
awplus(config)# interface port1.0.2
awplus(config-if)# switchport trunk native vlan none
```

To reset the native VLAN on interface port1.0.2 to the default VLAN 1, use the commands:

```
awplus# configure terminal
awplus(config)# interface port1.0.2
awplus(config-if)# no switchport trunk native vlan
```

Command changes Version 5.5.0-1.3: Support for up to 5 VLANs added to AR1050V

switchport voice dscp

Overview Use this command for a specific port to configure the Layer 3 DSCP value advertised when the transmission of LLDP-MED Network Policy TLVs for voice devices is enabled. When LLDP-MED capable IP phones receive this network policy information, they transmit voice data with the specified DSCP value.

Use the **no** variant of this command to reset the DSCP value to the default, 0.

Syntax `switchport voice dscp <0-63>`
`no switchport voice dscp`

Parameter	Description
dscp	Specify a DSCP value for voice data.
<0-63>	DSCP value.

Default A DSCP value of 0 will be advertised.

Mode Interface Configuration

Usage notes LLDP-MED advertisements including Network Policy TLVs are transmitted via a port if:

- LLDP is enabled (`lldp run` command)
- Voice VLAN is configured for the port (`switchport voice vlan` command)
- The port is configured to transmit LLDP advertisements—enabled by default (`lldp transmit receive` command)
- The port is configured to transmit Network Policy TLVs—enabled by default (`lldp med-tlv-select` command)
- There is an LLDP-MED device connected to the port

Example To tell IP phones connected to port1.0.2 to send voice data with DSCP value 27, use the commands:

```
awplus# configure terminal
awplus(config)# interface port1.0.2
awplus(config-if)# switchport voice dscp 27
```

Related commands `lldp med-tlv-select`
`show lldp`
`switchport voice vlan`

switchport voice vlan

Overview Use this command to configure the Voice VLAN tagging advertised when the transmission of LLDP-MED Network Policy TLVs for voice endpoint devices is enabled. When LLDP-MED capable IP phones receive this network policy information, they transmit voice data with the specified tagging. This command also sets the ports to be spanning tree edge ports, that is, it enables spanning tree portfast on the ports.

Use the **no** variant of this command to remove LLDP-MED network policy configuration for voice devices connected to these ports. This does not change the spanning tree edge port status.

Syntax `switchport voice vlan [<vid>|dot1p|dynamic|untagged]`
`no switchport voice vlan`

Parameter	Description
dot1p	The IP phone should send User Priority tagged packets, that is, packets in which the tag contains a User Priority value, and a VID of 0. (The User Priority tag is also known as the 802.1p priority tag, or the Class of Service (CoS) tag.)
dynamic	The VLAN ID with which the IP phone should send tagged packets will be assigned by RADIUS authentication.
untagged	The IP phone should send untagged packets.

Default By default, no Voice VLAN is configured, and therefore no network policy is advertised for voice devices.

Mode Interface Configuration

Usage notes LLDP-MED advertisements including Network Policy TLVs are transmitted via a port if:

- LLDP is enabled (`lldp run` command)
- Voice VLAN is configured for the port using this command (`switchport voice vlan`)
- The port is configured to transmit LLDP advertisements—enabled by default (`lldp transmit receive` command)
- The port is configured to transmit Network Policy TLVs—enabled by default (`lldp med-tlv-select` command)
- There is an LLDP-MED device connected to the port.

To set the priority value to be advertised for tagged frames, use the `switchport voice vlan priority` command.

If the Voice VLAN details are to be assigned by RADIUS, then the RADIUS server must be configured to send the attribute “Egress-VLANID (56)” or

“Egress-VLAN-Name (58)” in the RADIUS Accept message when authenticating a phone attached to this port.

Examples To tell IP phones connected to port1.0.4 to send voice data tagged for VLAN 10, use the commands:

```
awplus# configure terminal
awplus(config)# interface port1.0.4
awplus(config-if)# switchport voice vlan 10
```

To tell IP phones connected to port1.0.2-port1.0.8 to send priority tagged packets (802.1p priority tagged with VID 0, so that they will be assigned to the port VLAN) use the following commands. The priority value is 5 by default, but can be configured with the [switchport voice vlan priority](#) command.

```
awplus# configure terminal
awplus(config)# interface port1.0.2-port1.0.8
awplus(config-if)# switchport voice vlan dot1p
```

To dynamically configure the VLAN ID advertised to IP phones connected to port1.0.1 based on the VLAN assigned by RADIUS authentication (with RADIUS attribute “Egress- VLANID” or “Egress-VLAN-Name” in the RADIUS accept packet), use the commands:

```
awplus# configure terminal
awplus(config)# interface port1.0.1
awplus(config-if)# switchport voice vlan dynamic
```

To remove the Voice VLAN, and therefore disable the transmission of LLDP-MED network policy information for voice devices on port1.0.8, use the following commands:

```
awplus# configure terminal
awplus(config)# interface port1.0.8
awplus(config-if)# no switchport voice vlan
```

Related commands [switchport voice dscp](#)
[switchport voice vlan priority](#)

switchport voice vlan priority

Overview Use this command to configure the Layer 2 user priority advertised when the transmission of LLDP-MED Network Policy TLVs for voice devices is enabled. This is the priority in the User Priority field of the IEEE 802.1Q VLAN tag, also known as the Class of Service (CoS), or 802.1p priority. When LLDP-MED capable IP phones receive this network policy information, they transmit voice data with the specified priority.

Syntax `switchport voice vlan priority <0-7>`
`no switchport voice vlan priority`

Parameter	Description
<code>priority</code>	Specify a user priority value for voice data.
<code><0-7></code>	Priority value.

vlan

Overview This command creates VLANs, assigns names to them, and enables or disables them. Disabling the VLAN causes all forwarding over the specified VLAN ID to cease. Enabling the VLAN allows forwarding of frames on the specified VLAN.

You can create a management-only VLAN that contains only one member port and may be used as a remote management port. Management-only VLANs process packets in the CPU rather than in hardware. See the parameter table below for more detail.

The **no** variant of this command destroys the specified VLANs or returns their MTU to the default.

Syntax

```
vlan <vid> [name <vlan-name>] [state {enable|disable|management-only}]
vlan <vid-range> [state {enable|disable|management-only}]
vlan {<vid>|<vlan-name>} [mtu <mtu-value>]
no vlan {<vid>|<vid-range>} [mtu]
```

Parameter	Description
<vid>	The VID of the VLAN to enable or disable, in the range 1-4094.
<vlan-name>	The ASCII name of the VLAN. Maximum length: 32 characters.
<vid-range>	Specifies a range of VLAN identifiers.
<mtu-value>	Specifies the Maximum Transmission Unit (MTU) size in bytes, in the range 68 to 1500 bytes, for the VLAN.
enable	Puts the VLAN into an enabled state.
disable	Puts the VLAN into a disabled state.
management-only	Management-only VLANs are VLANs which: <ul style="list-style-type: none"> • have one and only one access port (no aggregators, trunk port etc.) • do not route to/from other interfaces. • process packets in the CPU, rather than in hardware. • cannot be converted to a normal VLAN, nor can a normal VLAN be converted to a management-only VLAN. Delete and re-create the VLAN to convert a normal VLAN to/from a management-only VLAN.

Default By default, VLANs are enabled when they are created.

Mode VLAN Configuration

Examples To enable VLAN 45, use the commands:

```
awplus# configure terminal
awplus(config)# vlan database
awplus(config-vlan)# vlan 45 name accounts state enable
```

To destroy VLAN 45, use the commands:

```
awplus# configure terminal
awplus(config)# vlan database
awplus(config-vlan)# no vlan 45
```

To create a management-only VLAN with VID 100, use the commands:

```
awplus# configure terminal
awplus(config)# vlan database
awplus(config-vlan)# vlan 100 state management-only
```

Related commands

- [mtu](#)
- [vlan database](#)
- [show vlan](#)

Command changes

- Version 5.4.9-2.1: Parameter **management-only** added
- Version 5.5.0-1.3: Support for up to 5 VLANs added to AR1050V

vlan database

Overview Use this command to enter the VLAN Configuration mode. You can then add or delete a VLAN, or modify its values.

Syntax `vlan database`

Mode Global Configuration

Example In the following example, note the change to VLAN Configuration mode from Global Configuration mode:

```
awplus# configure terminal
awplus(config)# vlan database
awplus(config-vlan)#
```

Related commands [vlan](#)

Command changes Version 5.5.0-1.3: Support for up to 5 VLANs added to AR1050V

16

Spanning Tree Commands

Introduction

Overview This chapter provides an alphabetical reference for commands used to configure RSTP, STP or MSTP. For information about spanning trees, including configuration procedures, see the [STP Feature Overview and Configuration Guide](#).

- Command List**
- [“clear spanning-tree statistics”](#) on page 568
 - [“clear spanning-tree detected protocols \(RSTP and MSTP\)”](#) on page 569
 - [“debug mstp \(RSTP and STP\)”](#) on page 570
 - [“instance priority \(MSTP\)”](#) on page 574
 - [“instance vlan \(MSTP\)”](#) on page 576
 - [“region \(MSTP\)”](#) on page 578
 - [“revision \(MSTP\)”](#) on page 579
 - [“show debugging mstp”](#) on page 580
 - [“show spanning-tree”](#) on page 581
 - [“show spanning-tree brief”](#) on page 584
 - [“show spanning-tree mst”](#) on page 585
 - [“show spanning-tree mst config”](#) on page 586
 - [“show spanning-tree mst detail”](#) on page 587
 - [“show spanning-tree mst detail interface”](#) on page 589
 - [“show spanning-tree mst instance”](#) on page 591
 - [“show spanning-tree mst instance interface”](#) on page 592
 - [“show spanning-tree mst interface”](#) on page 593
 - [“show spanning-tree statistics”](#) on page 594
 - [“show spanning-tree statistics instance”](#) on page 596

- ["show spanning-tree statistics instance interface"](#) on page 597
- ["show spanning-tree statistics interface"](#) on page 599
- ["show spanning-tree vlan range-index"](#) on page 601
- ["spanning-tree autoedge \(RSTP and MSTP\)"](#) on page 602
- ["spanning-tree cisco-interoperability \(MSTP\)"](#) on page 603
- ["spanning-tree edgeport \(RSTP and MSTP\)"](#) on page 604
- ["spanning-tree enable"](#) on page 605
- ["spanning-tree errdisable-timeout enable"](#) on page 607
- ["spanning-tree errdisable-timeout interval"](#) on page 608
- ["spanning-tree force-version"](#) on page 609
- ["spanning-tree forward-time"](#) on page 610
- ["spanning-tree guard root"](#) on page 611
- ["spanning-tree hello-time"](#) on page 612
- ["spanning-tree link-type"](#) on page 613
- ["spanning-tree max-age"](#) on page 614
- ["spanning-tree max-hops \(MSTP\)"](#) on page 615
- ["spanning-tree mode"](#) on page 616
- ["spanning-tree mst configuration"](#) on page 617
- ["spanning-tree mst instance"](#) on page 618
- ["spanning-tree mst instance path-cost"](#) on page 619
- ["spanning-tree mst instance priority"](#) on page 621
- ["spanning-tree mst instance restricted-role"](#) on page 622
- ["spanning-tree mst instance restricted-tcn"](#) on page 624
- ["spanning-tree path-cost"](#) on page 625
- ["spanning-tree portfast \(STP\)"](#) on page 626
- ["spanning-tree portfast bpdu-filter"](#) on page 628
- ["spanning-tree portfast bpdu-guard"](#) on page 630
- ["spanning-tree priority \(bridge priority\)"](#) on page 632
- ["spanning-tree priority \(port priority\)"](#) on page 633
- ["spanning-tree restricted-role"](#) on page 634
- ["spanning-tree restricted-tcn"](#) on page 635
- ["spanning-tree transmit-holdcount"](#) on page 636
- ["undebg mstp"](#) on page 637

clear spanning-tree statistics

Overview Use this command to clear all the STP BPDU (Bridge Protocol Data Unit) statistics.

Syntax `clear spanning-tree statistics`
`clear spanning-tree statistics [instance <mstp-instance>]`
`clear spanning-tree statistics [interface <port> [instance <mstp-instance>]]`

Parameter	Description
<port>	The port to clear STP BPDU statistics for. The port may be a switch port (e.g. port1.0.4), a static channel group (e.g. sa2), or a dynamic (LACP) channel group (e.g. po2).
<mstp-instance>	The MSTP instance (MSTI - Multiple Spanning Tree Instance) to clear MSTP BPDU statistics.

Mode User Exec and Privileged Exec

Usage notes Use this command with the **instance** parameter in MSTP mode. Specifying this command with the **interface** parameter only not the instance parameter will work in STP and RSTP mode.

Examples `awplus# clear spanning-tree statistics`
`awplus# clear spanning-tree statistics instance 1`
`awplus# clear spanning-tree statistics interface port1.0.2`
`awplus# clear spanning-tree statistics interface port1.0.2 instance 1`

clear spanning-tree detected protocols (RSTP and MSTP)

Overview Use this command to clear the detected protocols for a specific port, or all ports.
Use this command in RSTP or MSTP mode only.

Syntax `clear spanning-tree detected protocols [interface <port>]`

Parameter	Description
<code><port></code>	The port to clear detected protocols for. The port may be a switch port (e.g. <code>port1.0.4</code>), a static channel group (e.g. <code>sa2</code>), or a dynamic (LACP) channel group (e.g. <code>po2</code>).

Mode Privileged Exec

Example `awplus# clear spanning-tree detected protocols`

debug mstp (RSTP and STP)

Overview Use this command to enable debugging for the configured spanning tree mode, and echo data to the console, at various levels. Note that although this command uses the keyword **mstp** it displays debugging output for RSTP and STP protocols as well the MSTP protocol.

Use the **no** variant of this command to disable spanning tree debugging.

Syntax

```
debug mstp {all|cli|protocol [detail]|timer [detail]}
debug mstp {packet {rx|tx} [decode] [interface <interface>]}
debug mstp {topology-change [interface <interface>]}
no debug mstp {all|cli|protocol [detail]|timer [detail]}
no debug mstp {packet {rx|tx} [decode] [interface <interface>]}
no debug mstp {topology-change [interface <interface>]}
```

Parameter	Description
all	Echoes all spanning tree debugging levels to the console.
cli	Echoes spanning tree commands to the console.
packet	Echoes spanning tree packets to the console.
rx	Received packets.
tx	Transmitted packets.
protocol	Echoes protocol changes to the console.
timer	Echoes timer information to the console.
detail	Detailed output.
decode	Interprets packet contents
topology-change	Interprets topology change messages
interface	Keyword before <interface> placeholder to specify an interface to debug
<interface>	Placeholder used to specify the name of the interface to debug.

Mode Privileged Exec and Global Configuration mode

Usage 1 Use the **debug mstp topology-change interface** command to generate debugging messages when the device receives an indication of a topology change in a BPDU from another device. The debugging can be activated on a per-port basis. Although this command uses the keyword **mstp**, it displays debugging output for RSTP and STP protocols as well as the MSTP protocol.

Due to the likely volume of output, these debug messages are best viewed using the [terminal monitor](#) command before issuing the relevant **debug mstp**

command. The default terminal monitor filter will select and display these messages. Alternatively, the messages can be directed to any of the other log outputs by adding a filter for the MSTP application using [log buffered \(filter\)](#) command:

```
awplus# configure terminal
awplus(config)# log buffered program mstp
```

Output 1

```
awplus#terminal monitor
awplus#debug mstp topology-change interface port1.0.4
10:09:09 awplus MSTP[1409]: Topology change rcvd on port1.0.4 (internal)
10:09:09 awplus MSTP[1409]: Topology change rcvd on MSTI 1 port1.0.4
awplus#debug mstp topology-change interface port1.0.6
10:09:29 awplus MSTP[1409]: Topology change rcvd on port1.0.6 (external)
10:09:29 awplus MSTP[1409]: Topology change rcvd on MSTI 1 port1.0.6
```

Usage 2 Use the **debug mstp packet rx|tx decode interface** command to generate debugging messages containing the entire contents of a BPDU displayed in readable text for transmitted and received xSTP BPDUs. The debugging can be activated on a per-port basis and transmit and receive debugging is controlled independently. Although this command uses the keyword **mstp**, it displays debugging output for RSTP and STP protocols as well as the MSTP protocol.

Due to the likely volume of output, these debug messages are best viewed using the [terminal monitor](#) command before issuing the relevant **debug mstp** command. The default terminal monitor filter will select and display these messages. Alternatively, the messages can be directed to any of the other log outputs by adding a filter for the MSTP application using the [log buffered \(filter\)](#) command:

```
awplus(config)# log buffered program mstp
```

Output 2 In MSTP mode - an MSTP BPDU with 1 MSTI:

```
awplus#terminal monitor
awplus#debug mstp packet rx decode interface port1.0.4
17:23:42 awplus MSTP[1417]: port1.0.4 xSTP BPDU rx - start
17:23:42 awplus MSTP[1417]: Protocol version: MSTP, BPDU type: RST
17:23:42 awplus MSTP[1417]: CIST Flags: Agree Forward Learn role=Desig
17:23:42 awplus MSTP[1417]: CIST root id      : 0000:0000cd1000fe
17:23:42 awplus MSTP[1417]: CIST ext pathcost : 0
17:23:42 awplus MSTP[1417]: CIST reg root id  : 0000:0000cd1000fe
17:23:42 awplus MSTP[1417]: CIST port id     : 8001 (128:1)
17:23:42 awplus MSTP[1417]: msg age: 0 max age: 20 hellotime: 2 fwd delay: 15
17:23:42 awplus MSTP[1417]: Version 3 length : 80
17:23:42 awplus MSTP[1417]: Format id       : 0
17:23:42 awplus MSTP[1417]: Config name    : test
17:23:42 awplus MSTP[1417]: Revision level : 0
17:23:42 awplus MSTP[1417]: Config digest  : 3ab68794d602fdf43b21c0b37ac3bca8
17:23:42 awplus MSTP[1417]: CIST int pathcost : 0
17:23:42 awplus MSTP[1417]: CIST bridge id   : 0000:0000cd1000fe
17:23:42 awplus MSTP[1417]: CIST hops remaining : 20
17:23:42 awplus MSTP[1417]: MSTI flags      : Agree Forward Learn role=Desig
17:23:42 awplus MSTP[1417]: MSTI reg root id  : 8001:0000cd1000fe
17:23:42 awplus MSTP[1417]: MSTI pathcost   : 0
17:23:42 awplus MSTP[1417]: MSTI bridge priority : 32768 port priority : 128
17:23:42 awplus MSTP[1417]: MSTI hops remaining : 20
17:23:42 awplus MSTP[1417]: port1.0.4 xSTP BPDU rx - finish
```

In STP mode transmitting a TCN BPDU:

```
awplus#terminal monitor
awplus#debug mstp packet tx decode interface port1.0.4
17:28:09 awplus MSTP[1417]: port1.0.4 xSTP BPDU tx - start
17:28:09 awplus MSTP[1417]: Protocol version: STP, BPDU type: TCN
17:28:09 awplus MSTP[1417]: port1.0.4 xSTP BPDU tx - finish
```

In STP mode receiving an STP BPDU:

```
awplus#terminal monitor
awplus#debug mstp packet rx decode interface port1.0.4
17:31:36 awplus MSTP[1417]: port1.0.4 xSTP BPDU rx - start
17:31:36 awplus MSTP[1417]: Protocol version: STP, BPDU type: Config
17:31:36 awplus MSTP[1417]: Flags: role=none
17:31:36 awplus MSTP[1417]: Root id       : 8000:0000cd1000fe
17:31:36 awplus MSTP[1417]: Root pathcost : 0
17:31:36 awplus MSTP[1417]: Bridge id    : 8000:0000cd1000fe
17:31:36 awplus MSTP[1417]: Port id     : 8001 (128:1)
17:31:36 awplus MSTP[1417]: msg age: 0 max age: 20 hellotime: 2 fwd delay: 15
17:31:36 awplus MSTP[1417]: port1.0.4 xSTP BPDU rx - finish
```

In RSTP mode receiving an RSTP BPDU:

```
awplus#terminal monitor
awplus#debug mstp packet rx decode interface port1.0.4
awplus#17:30:17 awplus MSTP[1417]: port1.0.4 xSTP BPDU rx - start
17:30:17 awplus MSTP[1417]: Protocol version: RSTP, BPDU type: RST
17:30:17 awplus MSTP[1417]: CIST Flags: Forward Learn role=Desig
17:30:17 awplus MSTP[1417]: CIST root id      : 8000:0000cd1000fe
17:30:17 awplus MSTP[1417]: CIST ext pathcost : 0
17:30:17 awplus MSTP[1417]: CIST reg root id  : 8000:0000cd1000fe
17:30:17 awplus MSTP[1417]: CIST port id     : 8001 (128:1)
17:30:17 awplus MSTP[1417]: msg age: 0 max age: 20 hellotime: 2 fwd delay: 15
17:30:17 awplus MSTP[1417]: port1.0.4 xSTP BPDU rx - finish
```

Examples

```
awplus# debug mstp all
awplus# debug mstp cli
awplus# debug mstp packet rx
awplus# debug mstp protocol detail
awplus# debug mstp timer
awplus# debug mstp packet rx decode interface port1.0.2
awplus# debug mstp packet tx decode interface port1.0.6
```

Related commands

- [log buffered \(filter\)](#)
- [show debugging mstp](#)
- [terminal monitor](#)
- [undebug mstp](#)

instance priority (MSTP)

Overview Use this command to set the priority for this device to become the root bridge for the specified MSTI (Multiple Spanning Tree Instance).

Use this command for MSTP only.

Use the **no** variant of this command to restore the root bridge priority of the device for the instance to the default.

Syntax `instance <instance-id> priority <priority>`
`no instance <instance-id> priority`

Parameter	Description
<code><instance-id></code>	Specify an MSTP instance in the range 1-5.
<code><priority></code>	Specify the root bridge priority for the device for the MSTI in the range <0-61440>. Note that a lower priority number indicates a greater likelihood of the device becoming the root bridge. The priority values can be set only in increments of 4096. If you specify a number that is not a multiple of 4096, it will be rounded down. The default priority is 32768.

Default The default priority value for all instances is 32768.

Mode MST Configuration

Usage notes MSTP lets you distribute traffic more efficiently across a network by blocking different links for different VLANs. You do this by making different devices into the root bridge for each MSTP instance, so that each instance blocks a different link.

If all devices have the same root bridge priority for the instance, MSTP selects the device with the lowest MAC address to be the root bridge. Give the device a higher priority for becoming the root bridge for a particular instance by assigning it a lower priority number, or vice versa.

Examples To set the root bridge priority for MSTP instance 2 to be the highest (0), so that it will be the root bridge for this instance when available, use the commands:

```
awplus# configure terminal
awplus(config)# spanning-tree mst configuration
awplus(config-mst)# instance 2 priority 0
```

To reset the root bridge priority for instance 2 to the default (32768), use the commands:

```
awplus# configure terminal
awplus(config)# spanning-tree mst configuration
awplus(config-mst)# no instance 2 priority
```

Related commands

- region (MSTP)
- revision (MSTP)
- show spanning-tree mst config
- spanning-tree mst instance
- spanning-tree mst instance priority

instance vlan (MSTP)

Overview Use this command to create an MST Instance (MSTI), and associate the specified VLANs with it. An MSTI is a spanning tree instance that exists within an MST region (MSTR).

When a VLAN is associated with an MSTI the member ports of the VLAN are automatically configured to send and receive spanning-tree information for the associated MSTI. You can disable this automatic configuration of member ports of the VLAN to the associated MSTI by using a **no spanning-tree mst instance** command to remove the member port from the MSTI.

Use the **instance vlan** command for MSTP only.

Use the **no** variant of this command to remove the specified VLANs from the MSTI.

Syntax `instance <instance-id> vlan <vid-list>`
`no instance <instance-id> vlan <vid-list>`

Parameter	Description
<code><instance-id></code>	Specify an MSTP instance in the range 1-5.
<code><vid-list></code>	Specify one or more VLAN identifiers (VID) to be associated with the MSTI specified. This can be a single VID in the range 1-4094, or a hyphen-separated range or a comma-separated list of VLAN IDs.

Mode MST Configuration

Usage notes The VLANs must be created before being associated with an MST instance (MSTI). If the VLAN range is not specified, the MSTI will not be created.

This command removes the specified VLANs from the CIST and adds them to the specified MSTI. If you use the **no** variant of this command to remove the VLAN from the MSTI, it returns it to the CIST. To move a VLAN from one MSTI to another, you must first use the **no** variant of this command to return it to the CIST.

Ports in these VLANs will remain in the control of the CIST until you associate the ports with the MSTI using the [spanning-tree mst instance](#) command.

Example To associate VLAN 30 with MSTI 2, use the commands:

```
awplus# configure terminal
awplus(config)# spanning-tree mode mstp
awplus(config)# spanning-tree mst configuration
awplus(config-mst)# instance 2 vlan 30
```

Related commands

- region (MSTP)
- revision (MSTP)
- show spanning-tree mst config
- spanning-tree mst instance
- vlan

region (MSTP)

Overview Use this command to assign a name to the device's MST Region. MST Instances (MSTI) of a region form different spanning trees for different VLANs.

Use this command for MSTP only.

Use the **no** variant of this command to remove this region name and reset it to the default.

Syntax `region <region-name>`
`no region`

Parameter	Description
<code><region-name></code>	Specify the name of the region, up to 32 characters. Valid characters are upper-case, lower-case, digits, underscore.

Default By default, the region name is My Name.

Mode MST Configuration

Usage The region name, the revision number, and the digest of the VLAN to MSTI configuration table must be the same on all devices that are intended to be in the same MST region.

Example

```
awplus# configure terminal
awplus(config)# spanning-tree mst configuration
awplus(config-mst)# region ATL
```

Related commands [revision \(MSTP\)](#)
[show spanning-tree mst config](#)

revision (MSTP)

Overview Use this command to specify the MST revision number to be used in the configuration identifier.

Use this command for MSTP only.

Syntax `revision <revision-number>`

Parameter	Description
<code><revision-number></code>	<code><0-65535></code> Revision number.

Default The default of revision number is 0.

Mode MST Configuration

Usage The region name, the revision number, and the digest of the VLAN to MSTI configuration table must be the same on all devices that are intended to be in the same MST region.

Example

```
awplus# configure terminal
awplus(config)# spanning-tree mst configuration
awplus(config-mst)# revision 25
```

Related commands

- [region \(MSTP\)](#)
- [show spanning-tree mst config](#)
- [instance vlan \(MSTP\)](#)

show debugging mstp

Overview Use this command to see what debugging is turned on for MSTP.
For information on filtering and saving command output, see the [“Getting Started with AlliedWare Plus” Feature Overview and Configuration Guide](#).

Syntax `show debugging mstp`

Mode User Exec and Privileged Exec

Example To display the MSTP debugging options set, enter the command:

```
awplus# show debugging mstp
```

Output Figure 16-1: Example output from **show debugging mstp**

```
MSTP debugging status:  
MSTP receiving packet debugging is on
```

Related commands [debug mstp \(RSTP and STP\)](#)

show spanning-tree

Overview Use this command to display detailed spanning tree information on the specified port or on all ports. Use this command for RSTP, MSTP or STP.

For information on filtering and saving command output, see the [“Getting Started with AlliedWare Plus” Feature Overview and Configuration Guide](#).

Syntax `show spanning-tree [interface <port-list>]`

Parameter	Description
<code>interface</code>	Display information about the following port only.
<code><port-list></code>	The ports to display information about. A port-list can be: <ul style="list-style-type: none">• a switch port (e.g. port1.0.6) a static channel group (e.g. sa2) or a dynamic (LACP) channel group (e.g. po2)• a continuous range of ports separated by a hyphen, e.g. port1.0.1-1.0.4, or sa1-2, or po1-2• a comma-separated list of ports and port ranges, e.g. port1.0.1,port1.0.4-1.0.6. Do not mix switch ports, static channel groups, and dynamic (LACP) channel groups in the same list

Mode User Exec and Privileged Exec

Usage notes Note that any list of interfaces specified must not span any interfaces that are not installed.

A topology change counter has been included for RSTP and MSTP. You can see the topology change counter for RSTP by using the **show spanning-tree** command. You can see the topology change counter for MSTP by using the **show spanning-tree mst instance** command.

Example To display spanning tree information about port1.0.3, use the command:

```
awplus# show spanning-tree interface port1.0.3
```

Output Figure 16-2: Example output from **show spanning-tree** in RSTP mode

```
awplus#show spanning-tree
% 1: Bridge up - Spanning Tree Enabled
% 1: Root Path Cost 0 - Root Port 0 - Bridge Priority 32768
% 1: Forward Delay 15 - Hello Time 2 - Max Age 20
% 1: Root Id 80000000cd24ff2d
% 1: Bridge Id 80000000cd24ff2d
% 1: last topology change Mon Oct 3 02:06:26 2016
% 1: portfast bpdu-filter disabled
% 1: portfast bpdu-guard disabled
% 1: portfast errdisable timeout disabled
% 1: portfast errdisable timeout interval 300 sec
% port1.0.1: Port 5001 - Id 8389 - Role Disabled - State Discarding
% port1.0.1: Designated Path Cost 0
% port1.0.1: Configured Path Cost 20000000 - Add type Explicit ref count 1
% port1.0.1: Designated Port Id 8389 - Priority 128 -
% port1.0.1: Root 80000000cd24ff2d
% port1.0.1: Designated Bridge 80000000cd24ff2d
% port1.0.1: Message Age 0 - Max Age 20
% port1.0.1: Hello Time 2 - Forward Delay 15
% port1.0.1: Forward Timer 0 - Msg Age Timer 0 - Hello Timer 0 - topo change
timer 0
% port1.0.1: forward-transitions 0
% port1.0.1: Version Rapid Spanning Tree Protocol - Received None - Send STP
% port1.0.1: No portfast configured - Current portfast off
% port1.0.1: portfast bpdu-guard default - Current portfast bpdu-guard off
% port1.0.1: portfast bpdu-filter default - Current portfast bpdu-filter off
% port1.0.1: no root guard configured - Current root guard off
% port1.0.1: Configured Link Type point-to-point - Current shared
%
% port1.0.2: Port 5002 - Id 838a - Role Disabled - State Discarding
% port1.0.2: Designated Path Cost 0
% port1.0.2: Configured Path Cost 20000000 - Add type Explicit ref count 1
% port1.0.2: Designated Port Id 838a - Priority 128 -
% port1.0.2: Root 80000000cd24ff2d
% port1.0.2: Designated Bridge 80000000cd24ff2d
% port1.0.2: Message Age 0 - Max Age 20
% port1.0.2: Hello Time 2 - Forward Delay 15
% port1.0.2: Forward Timer 0 - Msg Age Timer 0 - Hello Timer 0 - topo change
timer 0
% port1.0.2: forward-transitions 0
% port1.0.2: Version Rapid Spanning Tree Protocol - Received None - Send STP
% port1.0.2: No portfast configured - Current portfast off
% port1.0.2: portfast bpdu-guard default - Current portfast bpdu-guard off
% port1.0.2: portfast bpdu-filter default - Current portfast bpdu-filter off
% port1.0.2: no root guard configured - Current root guard off
% port1.0.2: Configured Link Type point-to-point - Current shared
```

Output Figure 16-3: Example output from **show spanning-tree**

```
% 1: Bridge up - Spanning Tree Enabled
% 1: Root Path Cost 0 - Root Port 0 - Bridge Priority 32768
% 1: Forward Delay 15 - Hello Time 2 - Max Age 20
% 1: Root Id 80000000cd20f093
% 1: Bridge Id 80000000cd20f093
% 1: last topology change Mon Oct 3 02:06:26 2016
% 1: portfast bpdu-filter disabled
% 1: portfast bpdu-guard disabled
% 1: portfast errdisable timeout disabled
% 1: portfast errdisable timeout interval 300 sec
% port1.0.3: Port 5023 - Id 839f - Role Designated - State Forwarding
% port1.0.3: Designated Path Cost 0
% port1.0.3: Configured Path Cost 200000 - Add type Explicit ref count 1
% port1.0.3: Designated Port Id 839f - Priority 128 -
% port1.0.3: Root 80000000cd20f093
% port1.0.3: Designated Bridge 80000000cd20f093
% port1.0.3: Message Age 0 - Max Age 20
% port1.0.3: Hello Time 2 - Forward Delay 15
% port1.0.3: Forward Timer 0 - Msg Age Timer 0 - Hello Timer 1 - topo change
timer 0
% port1.0.3: forward-transitions 32
% port1.0.3: Version Rapid Spanning Tree Protocol - Received None - Send RSTP
% port1.0.3: No portfast configured - Current portfast off
% port1.0.3: portfast bpdu-guard default - Current portfast bpdu-guard off
% port1.0.3: portfast bpdu-filter default - Current portfast bpdu-filter off
% port1.0.3: no root guard configured - Current root guard off
% port1.0.3: Configured Link Type point-to-point - Current point-to-point
...
```

show spanning-tree brief

Overview Use this command to display a summary of spanning tree status information on all ports. Use this command for RSTP, MSTP or STP.

Syntax `show spanning-tree brief`

Parameter	Description
brief	A brief summary of spanning tree information.

Mode User Exec and Privileged Exec

Usage notes Note that any list of interfaces specified must not span any interfaces that are not installed.

A topology change counter has been included for RSTP and MSTP. You can see the topology change counter for RSTP by using the **show spanning-tree** command. You can see the topology change counter for MSTP by using the **show spanning-tree mst instance** command.

Example To display a summary of spanning tree status information, use the command:

```
awplus# show spanning-tree brief
```

Output Figure 16-4: Example output from **show spanning-tree brief**

```
Default: Bridge up - Spanning Tree Enabled
Default: Root Path Cost 40000 - Root Port 4501 - Bridge Priority 32768
Default: Root Id 8000:0000cd250001
Default: Bridge Id 8000:0000cd296eb1

Port          Designated Bridge  Port Id  Role          State
sa1           8000:001577c9744b  8195    Rootport     Forwarding
po1           8000:0000cd296eb1  81f9    Designated   Forwarding
port1.0.1     8000:0000cd296eb1  8389    Disabled     Discarding
port1.0.2     8000:0000cd296eb1  838a    Disabled     Discarding
port1.0.3     8000:0000cd296eb1  838b    Disabled     Discarding
...
```

Related commands [show spanning-tree](#)

show spanning-tree mst

Overview This command displays bridge-level information about the CIST and VLAN to MSTI mappings.

For information on filtering and saving command output, see the [“Getting Started with AlliedWare Plus” Feature Overview and Configuration Guide](#).

Syntax `show spanning-tree mst`

Mode User Exec, Privileged Exec and Interface Configuration

Example To display bridge-level information about the CIST and VLAN to MSTI mappings, enter the command:

```
awplus# show spanning-tree mst
```

Output Figure 16-5: Example output from **show spanning-tree mst**

```
% 1: Bridge up - Spanning Tree Enabled
% 1: CIST Root Path Cost 0 - CIST Root Port 0 - CIST Bridge
Priority 32768
% 1: Forward Delay 15 - Hello Time 2 - Max Age 20 - Max-hops 20
% 1: CIST Root Id 8000000475e93ffe
% 1: CIST Reg Root Id 8000000475e93ffe
% 1: CST Bridge Id 8000000475e93ffe
% 1: portfast bpdu-filter disabled
% 1: portfast bpdu-guard disabled
% 1: portfast errdisable timeout disabled
% 1: portfast errdisable timeout interval 300 sec
%
% Instance      VLAN
% 0:            1
% 2:            4
```

Related commands [show spanning-tree mst interface](#)

show spanning-tree mst config

Overview Use this command to display MSTP configuration identifier for the device.

Syntax show spanning-tree mst config

Mode User Exec, Privileged Exec and Interface Configuration

Usage notes The region name, the revision number, and the digest of the VLAN to MSTI configuration table must be the same on all devices that are intended to be in the same MST region.

Example To display MSTP configuration identifier information, enter the command:

```
awplus# show spanning-tree mst config
```

Output Figure 16-6: Example output from **show spanning-tree mst config**

```
awplus#show spanning-tree mst config
%
%  MSTP Configuration Information:
%-----
%  Format Id      : 0
%  Name          : My Name
%  Revision Level : 0
%  Digest        : 0x80DEE46DA92A98CF21C603291B22880A
%-----
%
```

Related commands

- [instance vlan \(MSTP\)](#)
- [region \(MSTP\)](#)
- [revision \(MSTP\)](#)

show spanning-tree mst detail

Overview This command displays detailed information about each instance, and all interfaces associated with that particular instance.

For information on filtering and saving command output, see the [“Getting Started with AlliedWare Plus” Feature Overview and Configuration Guide](#).

Syntax show spanning-tree mst detail

Mode User Exec, Privileged Exec and Interface Configuration

Example To display detailed information about each instance, and all interfaces associated with them, enter the command:

```
awplus# show spanning-tree mst detail
```

Output Figure 16-7: Example output from **show spanning-tree mst detail**

```
% 1: Bridge up - Spanning Tree Enabled
% 1: CIST Root Path Cost 0 - CIST Root Port 0 - CIST Bridge Priority 32768
% 1: Forward Delay 15 - Hello Time 2 - Max Age 20 - Max-hops 20
% 1: CIST Root Id 80000000cd24ff2d
% 1: CIST Reg Root Id 80000000cd24ff2d
% 1: CIST Bridge Id 80000000cd24ff2d
% 1: portfast bpdu-filter disabled
% 1: portfast bpdu-guard disabled
% 1: portfast errdisable timeout disabled
% 1: portfast errdisable timeout interval 300 sec
% port1.0.1: Port 5001 - Id 8389 - Role Disabled - State Discarding
% port1.0.1: Designated External Path Cost 0 -Internal Path Cost 0
% port1.0.1: Configured Path Cost 20000000 - Add type Explicit ref count 1
% port1.0.1: Designated Port Id 8389 - CIST Priority 128 -
% port1.0.1: CIST Root 80000000cd24ff2d
% port1.0.1: Regional Root 80000000cd24ff2d
% port1.0.1: Designated Bridge 80000000cd24ff2d
% port1.0.1: Message Age 0 - Max Age 20
% port1.0.1: CIST Hello Time 2 - Forward Delay 15
% port1.0.1: CIST Forward Timer 0 - Msg Age Timer 0 - Hello Timer 0 - topo
change timer 0
...
% port1.0.2: forward-transitions 0
% port1.0.2: Version Multiple Spanning Tree Protocol - Received None - Send STP
% port1.0.2: No portfast configured - Current portfast off
% port1.0.2: portfast bpdu-guard default - Current portfast bpdu-guard off
% port1.0.2: portfast bpdu-filter default - Current portfast bpdu-filter off
% port1.0.2: no root guard configured - Current root guard off
% port1.0.2: Configured Link Type point-to-point - Current shared
%
```

```
% port1.0.3: Port 5003 - Id 838b - Role Disabled - State Discarding
% port1.0.3: Designated External Path Cost 0 -Internal Path Cost 0
% port1.0.3: Configured Path Cost 20000000 - Add type Explicit ref count 1
% port1.0.3: Designated Port Id 838b - CIST Priority 128 -
% port1.0.3: CIST Root 80000000cd24ff2d
% port1.0.3: Regional Root 80000000cd24ff2d
% port1.0.3: Designated Bridge 80000000cd24ff2d
% port1.0.3: Message Age 0 - Max Age 20
% port1.0.3: CIST Hello Time 2 - Forward Delay 15
% port1.0.3: CIST Forward Timer 0 - Msg Age Timer 0 - Hello Timer 0 - topo
change timer 0
% port1.0.3: forward-transitions 0
% port1.0.3: Version Multiple Spanning Tree Protocol - Received None - Send STP
% port1.0.3: No portfast configured - Current portfast off
% port1.0.3: portfast bpdu-guard default - Current portfast bpdu-guard off
% port1.0.3: portfast bpdu-filter default - Current portfast bpdu-filter off
% port1.0.3: no root guard configured - Current root guard off
% port1.0.3: Configured Link Type point-to-point - Current shared
```

show spanning-tree mst detail interface

Overview This command displays detailed information about the specified switch port, and the MST instances associated with it.

For information on filtering and saving command output, see the [“Getting Started with AlliedWare Plus” Feature Overview and Configuration Guide](#).

Syntax `show spanning-tree mst detail interface <port>`

Parameter	Description
<code><port></code>	The port to display information about. The port may be a switch port (e.g. <code>port1.0.4</code>), a static channel group (e.g. <code>sa2</code>), or a dynamic (LACP) channel group (e.g. <code>po2</code>).

Mode User Exec, Privileged Exec and Interface Configuration

Example To display detailed information about `port1.0.3` and the instances associated with it, enter the command:

```
awplus# show spanning-tree mst detail interface port1.0.3
```

Output Figure 16-8: Example output from **show spanning-tree mst detail interface**

```
% 1: Bridge up - Spanning Tree Enabled
% 1: CIST Root Path Cost 0 - CIST Root Port 0 - CIST Bridge Priority 32768
% 1: Forward Delay 15 - Hello Time 2 - Max Age 20 - Max-hops 20
% 1: CIST Root Id 80000000cd24ff2d
% 1: CIST Reg Root Id 80000000cd24ff2d
% 1: CIST Bridge Id 80000000cd24ff2d
% 1: portfast bpdu-filter disabled
% 1: portfast bpdu-guard disabled
% 1: portfast errdisable timeout disabled
% 1: portfast errdisable timeout interval 300 sec
% port1.0.2: Port 5002 - Id 838a - Role Disabled - State Discarding
% port1.0.2: Designated External Path Cost 0 -Internal Path Cost 0
% port1.0.2: Configured Path Cost 20000000 - Add type Explicit ref count 2
% port1.0.2: Designated Port Id 838a - CIST Priority 128 -
% port1.0.2: CIST Root 80000000cd24ff2d
% port1.0.2: Regional Root 80000000cd24ff2d
% port1.0.2: Designated Bridge 80000000cd24ff2d
% port1.0.2: Message Age 0 - Max Age 20
% port1.0.2: CIST Hello Time 2 - Forward Delay 15
% port1.0.2: CIST Forward Timer 0 - Msg Age Timer 0 - Hello Timer 0 - topo
change timer 0
% port1.0.2: forward-transitions 0
% port1.0.2: Version Multiple Spanning Tree Protocol - Received None - Send STP
```

```
% port1.0.2: No portfast configured - Current portfast off
% port1.0.2: portfast bpdu-guard default - Current portfast bpdu-guard off
% port1.0.2: portfast bpdu-filter default - Current portfast bpdu-filter off
% port1.0.2: no root guard configured - Current root guard off
% port1.0.2: Configured Link Type point-to-point - Current shared
%
% Instance 2: Vlans: 2
% 1: MSTI Root Path Cost 0 -MSTI Root Port 0 - MSTI Bridge Priority 32768
% 1: MSTI Root Id 80020000cd24ff2d
% 1: MSTI Bridge Id 80020000cd24ff2d
% port1.0.2: Port 5002 - Id 838a - Role Disabled - State Discarding
% port1.0.2: Designated Internal Path Cost 0 - Designated Port Id 838a
% port1.0.2: Configured Internal Path Cost 20000000
% port1.0.2: Configured CST External Path cost 20000000
% port1.0.2: CST Priority 128 - MSTI Priority 128
% port1.0.2: Designated Root 80020000cd24ff2d
% port1.0.2: Designated Bridge 80020000cd24ff2d
% port1.0.2: Message Age 0 - Max Age 0
% port1.0.2: Hello Time 2 - Forward Delay 15
% port1.0.2: Forward Timer 0 - Msg Age Timer 0 - Hello Timer 0
```

show spanning-tree mst instance

Overview This command displays detailed information for the specified instance, and all switch ports associated with that instance.

A topology change counter has been included for RSTP and MSTP. You can see the topology change counter for RSTP by using the [show spanning-tree](#) command. You can see the topology change counter for MSTP by using the **show spanning-tree mst instance** command.

For information on filtering and saving command output, see the [“Getting Started with AlliedWare Plus” Feature Overview and Configuration Guide](#).

Syntax `show spanning-tree mst instance <instance-id>`

Parameter	Description
<code><instance-id></code>	Specify an MSTP instance in the range 1-5.

Mode User Exec, Privileged Exec, and Interface Configuration

Example To display detailed information for **instance 2**, and all switch ports associated with that instance, use the command:

```
awplus# show spanning-tree mst instance 2
```

Output Figure 16-9: Example output from **show spanning-tree mst instance**

```
% 1: MSTI Root Path Cost 0 - MSTI Root Port 0 - MSTI Bridge Priority 32768
% 1: MSTI Root Id 80020000cd24ff2d
% 1: MSTI Bridge Id 80020000cd24ff2d
% port1.0.2: Port 5002 - Id 838a - Role Disabled - State Discarding
% port1.0.2: Designated Internal Path Cost 0 - Designated Port Id 838a
% port1.0.2: Configured Internal Path Cost 20000000
% port1.0.2: Configured CST External Path cost 20000000
% port1.0.2: CST Priority 128 - MSTI Priority 128
% port1.0.2: Designated Root 80020000cd24ff2d
% port1.0.2: Designated Bridge 80020000cd24ff2d
% port1.0.2: Message Age 0 - Max Age 0
% port1.0.2: Hello Time 2 - Forward Delay 15
% port1.0.2: Forward Timer 0 - Msg Age Timer 0 - Hello Timer 0
%
```

show spanning-tree mst instance interface

Overview This command displays detailed information for the specified MST (Multiple Spanning Tree) instance, and the specified switch port associated with that MST instance.

For information on filtering and saving command output, see the [“Getting Started with AlliedWare Plus” Feature Overview and Configuration Guide](#).

Syntax `show spanning-tree mst instance <instance-id> interface <port>`

Parameter	Description
<instance-id>	Specify an MSTP instance in the range 1-5.
<port>	The port to display information about. The port may be a switch port (e.g. port1.0.4), a static channel group (e.g. sa2), or a dynamic (LACP) channel group (e.g. po2).

Mode User Exec, Privileged Exec, and Interface Configuration

Example To display detailed information for instance 2, interface port1.0.2, use the command:

```
awplus# show spanning-tree mst instance 2 interface port1.0.2
```

Output Figure 16-10: Example output from **show spanning-tree mst instance**

```
% 1: MSTI Root Path Cost 0 - MSTI Root Port 0 - MSTI Bridge Priority 32768
% 1: MSTI Root Id 80020000cd24ff2d
% 1: MSTI Bridge Id 80020000cd24ff2d
% port1.0.2: Port 5002 - Id 838a - Role Disabled - State Discarding
% port1.0.2: Designated Internal Path Cost 0 - Designated Port Id 838a
% port1.0.2: Configured Internal Path Cost 20000000
% port1.0.2: Configured CST External Path cost 20000000
% port1.0.2: CST Priority 128 - MSTI Priority 128
% port1.0.2: Designated Root 80020000cd24ff2d
% port1.0.2: Designated Bridge 80020000cd24ff2d
% port1.0.2: Message Age 0 - Max Age 0
% port1.0.2: Hello Time 2 - Forward Delay 15
% port1.0.2: Forward Timer 0 - Msg Age Timer 0 - Hello Timer 0
%
```

show spanning-tree mst interface

Overview This command displays the number of instances created, and VLANs associated with it for the specified switch port.

For information on filtering and saving command output, see the [“Getting Started with AlliedWare Plus” Feature Overview and Configuration Guide](#).

Syntax `show spanning-tree mst interface <port>`

Parameter	Description
<code><port></code>	The port to display information about. The port may be a switch port (e.g. <code>port1.0.4</code>), a static channel group (e.g. <code>sa2</code>), or a dynamic (LACP) channel group (e.g. <code>po2</code>).

Mode User Exec, Privileged Exec, and Interface Configuration

Example To display detailed information about each instance, and all interfaces associated with them, for `port1.0.4`, use the command:

```
awplus# show spanning-tree mst interface port1.0.4
```

Output Figure 16-11: Example output from **show spanning-tree mst interface**

```
% 1: Bridge up - Spanning Tree Enabled
% 1: CIST Root Path Cost 0 - CIST Root Port 0 - CIST Bridge Priority 32768
% 1: Forward Delay 15 - Hello Time 2 - Max Age 20 - Max-hops 20
% 1: CIST Root Id 80000008c73a2b22
% 1: CIST Reg Root Id 80000008c73a2b22
% 1: CST Bridge Id 80000008c73a2b22
% 1: portfast bpdu-filter disabled
% 1: portfast bpdu-guard disabled
% 1: portfast errdisable timeout disabled
% 1: portfast errdisable timeout interval 1 sec
%
% Instance      VLAN
% 0:            1
% 1:            2-3
% 2:            4-5
```

show spanning-tree statistics

Overview This command displays BPDU (Bridge Protocol Data Unit) statistics for all spanning-tree instances, and all switch ports associated with all spanning-tree instances.

For information on filtering and saving command output, see the [“Getting Started with AlliedWare Plus” Feature Overview and Configuration Guide](#).

Syntax show spanning-tree statistics

Mode Privileged Exec

Usage notes To display BPDU statistics for all spanning-tree instances, and all switch ports associated with all spanning-tree instances, use the command:

```
awplus# show spanning-tree statistics
```

Output Figure 16-12: Example output from **show spanning-tree statistics**

```
=====
% BPDU Related Parameters
% -----
% Port Spanning Tree           : Disable
% Spanning Tree Type          : Rapid Spanning Tree Protocol
% Current Port State           : Discarding
% Port ID                      : 8393
% Port Number                  : 393
% Path Cost                    : 20000000
% Message Age                  : 0
% Designated Root              : ec:cd:6d:20:c0:ed
% Designated Cost              : 0
% Designated Bridge            : ec:cd:6d:20:c0:ed
% Designated Port Id          : 8393
% Top Change Ack               : FALSE
% Config Pending               : FALSE
% PORT Based Information & Statistics
% -----
% Config Bpdu's xmitted       : 0
% Config Bpdu's received      : 0
% TCN Bpdu's xmitted          : 0
% TCN Bpdu's received         : 0
% Forward Trans Count         : 0
```

```
% STATUS of Port Timers
% -----
% Hello Time Configured           : 2
% Hello timer                     : INACTIVE
% Hello Time Value                : 0
% Forward Delay Timer             : INACTIVE
% Forward Delay Timer Value       : 0
% Message Age Timer               : INACTIVE
% Message Age Timer Value        : 0
% Topology Change Timer          : INACTIVE
% Topology Change Timer Value    : 0
% Hold Timer                      : INACTIVE
% Hold Timer Value               : 0
% Other Port-Specific Info
% -----
% Max Age Transitions             : 1
% Msg Age Expiry                  : 0
% Similar BPDUS Rcvd             : 0
% Src Mac Count                   : 0
% Total Src Mac Rcvd              : 0
% Next State                      : Learning
% Topology Change Time           : 0
```

show spanning-tree statistics instance

Overview This command displays BPDU (Bridge Protocol Data Unit) statistics for the specified MST (Multiple Spanning Tree) instance, and all switch ports associated with that MST instance.

For information on filtering and saving command output, see the [“Getting Started with AlliedWare Plus” Feature Overview and Configuration Guide](#).

Syntax `show spanning-tree statistics instance <instance-id>`

Parameter	Description
<instance-id>	Specify an MSTP instance in the range 1-5.

Mode Privileged Exec

Example To display BPDU statistics information for MST instance 2, and all switch ports associated with that MST instance, use the command:

```
awplus# show spanning-tree statistics instance 2
```

Output Figure 16-13: Example output from **show spanning-tree statistics instance**

```
% % INST_PORT port1.0.3 Information & Statistics
% -----
% Config Bpdu's xmitted (port/inst)      : (0/0)
% Config Bpdu's received (port/inst)     : (0/0)
% TCN Bpdu's xmitted (port/inst)        : (0/0)
% TCN Bpdu's received (port/inst)       : (0/0)
% Message Age (port/Inst)                : (0/0)
% port1.0.3: Forward Transitions          : 0
% Next State                             : Learning
% Topology Change Time                   : 0
...

```

Related commands [show spanning-tree statistics](#)

show spanning-tree statistics instance interface

Overview This command displays BPDU (Bridge Protocol Data Unit) statistics for the specified MST (Multiple Spanning Tree) instance and the specified switch port associated with that MST instance.

For information on filtering and saving command output, see the [“Getting Started with AlliedWare Plus” Feature Overview and Configuration Guide](#).

Syntax `show spanning-tree statistics instance <instance-id> interface <port>`

Parameter	Description
<instance-id>	Specify an MSTP instance in the range 1-5.
<port>	The port to display information about. The port may be a switch port (e.g. port1.0.4), a static channel group (e.g. sa2), or a dynamic (LACP) channel group (e.g. po2).

Mode Privileged Exec

Example To display BPDU statistics for MST instance 2, interface port1.0.2, use the command:

```
awplus# show spanning-tree statistics instance 2 interface port1.0.2
```

Output Figure 16-14: Example output from **show spanning-tree statistics instance interface**

```
awplus#sh spanning-tree statistics interface port1.0.2 instance 1
Spanning Tree Enabled for Instance : 1
=====
% INST_PORT port1.0.2 Information & Statistics
% -----
% Config Bpdu's xmitted (port/inst)      : (0/0)
% Config Bpdu's received (port/inst)    : (0/0)
% TCN Bpdu's xmitted (port/inst)        : (0/0)
% TCN Bpdu's received (port/inst)       : (0/0)
% Message Age (port/Inst)                : (0/0)
% port1.0.2: Forward Transitions         : 0
% Next State                             : Learning
% Topology Change Time                   : 0

% Other Inst/Vlan Information & Statistics
% -----
% Bridge Priority                         : 0
% Bridge Mac Address                     : ec:cd:6d:20:c0:ed
% Topology Change Initiator              : 5023
% Last Topology Change Occured           : Mon Oct 3 05:42:06 2016
% Topology Change                        : FALSE
% Topology Change Detected                : FALSE
% Topology Change Count                  : 1
% Topology Change Last Recvd from        : 00:00:00:00:00:00
```

Related commands [show spanning-tree statistics](#)

show spanning-tree statistics interface

Overview This command displays BPDU (Bridge Protocol Data Unit) statistics for the specified switch port, and all MST instances associated with that switch port.

For information on filtering and saving command output, see the [“Getting Started with AlliedWare Plus” Feature Overview and Configuration Guide](#).

Syntax `show spanning-tree statistics interface <port>`

Parameter	Description
<code><port></code>	The port to display information about. The port may be a switch port (e.g. port1.0.2), a static channel group (e.g. sa2), or a dynamic (LACP) channel group (e.g. po2).

Mode Privileged Exec

Example To display BPDU statistics about each MST instance for port1.0.2, use the command:

```
awplus# show spanning-tree statistics interface port1.0.2
```

Output Figure 16-15: Example output from **show spanning-tree statistics interface**

```
awplus#show spanning-tree statistics interface port1.0.2

      Port number = 906 Interface = port1.0.2
      =====
% BPDU Related Parameters
% -----
% Port Spanning Tree           : Disable
% Spanning Tree Type          : Multiple Spanning Tree Protocol
% Current Port State           : Discarding
% Port ID                      : 838a
% Port Number                  : 38a
% Path Cost                    : 20000000
% Message Age                  : 0
% Designated Root              : ec:cd:6d:20:c0:ed
% Designated Cost              : 0
% Designated Bridge            : ec:cd:6d:20:c0:ed
% Designated Port Id           : 838a
% Top Change Ack               : FALSE
% Config Pending               : FALSE
```

```
% PORT Based Information & Statistics
% -----
% Config Bpdu's xmitted           : 0
% Config Bpdu's received          : 0
% TCN Bpdu's xmitted              : 0
% TCN Bpdu's received             : 0
% Forward Trans Count             : 0

% STATUS of Port Timers
% -----
% Hello Time Configured           : 2
% Hello timer                     : INACTIVE
% Hello Time Value                : 0
% Forward Delay Timer             : INACTIVE
% Forward Delay Timer Value       : 0
% Message Age Timer               : INACTIVE
% Message Age Timer Value         : 0
% Topology Change Timer          : INACTIVE
% Topology Change Timer Value    : 0
% Hold Timer                      : INACTIVE
% Hold Timer Value                : 0

% Other Port-Specific Info
% -----
% Max Age Transitions             : 1
% Msg Age Expiry                  : 0
% Similar BPDUS Rcvd             : 0
% Src Mac Count                   : 0
% Total Src Mac Rcvd             : 0
% Next State                      : Learning
% Topology Change Time           : 0
% Other Bridge information & Statistics
% -----
% STP Multicast Address           : 01:80:c2:00:00:00
% Bridge Priority                  : 32768
% Bridge Mac Address              : ec:cd:6d:20:c0:ed
% Bridge Hello Time               : 2
% Bridge Forward Delay            : 15
% Topology Change Initiator       : 5023
% Last Topology Change Occured    : Mon Oct 3 05:41:20 2016
% Topology Change                 : FALSE
% Topology Change Detected        : TRUE
% Topology Change Count           : 1
% Topology Change Last Recvd from : 00:00:00:00:00:00
```

Related commands [show spanning-tree statistics](#)

show spanning-tree vlan range-index

Overview Use this command to display information about MST (Multiple Spanning Tree) instances and the VLANs associated with them including the VLAN range-index value for the device.

Syntax `show spanning-tree vlan range-index`

Mode Privileged Exec

Example To display information about MST instances and the VLANs associated with them for the device, including the VLAN range-index value, use the following command:

```
awplus# show spanning-tree vlan range-index
```

Output Figure 16-16: Example output from **show spanning-tree vlan range-index**

```
awplus#show spanning-tree vlan range-index
% MST Instance  VLAN      RangeIdx
%      1         1         1%
```

Related commands [show spanning-tree statistics](#)

spanning-tree autoedge (RSTP and MSTP)

Overview Use this command to enable the autoedge feature on the port.

The autoedge feature allows the port to automatically detect that it is an edge port. If it does not receive any BPDUs in the first three seconds after linkup, enabling, or entering RSTP or MSTP mode, it sets itself to be an edgeport and enters the forwarding state.

Use this command for RSTP or MSTP.

Use the **no** variant of this command to disable this feature.

Syntax `spanning-tree autoedge`
`no spanning-tree autoedge`

Default Disabled

Mode Interface Configuration

Example `awplus# configure terminal`
`awplus(config)# interface port1.0.3`
`awplus(config-if)# spanning-tree autoedge`

Related commands [spanning-tree edgeport \(RSTP and MSTP\)](#)

spanning-tree cisco-interoperability (MSTP)

Overview Use this command to enable/disable Cisco-interoperability for MSTP.
Use this command for MSTP only.

Syntax `spanning-tree cisco-interoperability {enable|disable}`

Parameter	Description
enable	Enable Cisco interoperability for MSTP.
disable	Disable Cisco interoperability for MSTP.

Default If this command is not used, Cisco interoperability is disabled.

Mode Global Configuration

Usage For compatibility with certain Cisco devices, all devices in the switched LAN running the AlliedWare Plus™ Operating System must have Cisco-interoperability enabled. When the AlliedWare Plus Operating System is interoperating with Cisco, the only criteria used to classify a region are the region name and revision level. VLAN to instance mapping is not used to classify regions when interoperating with Cisco.

Examples To enable Cisco interoperability on a Layer 2 device:

```
awplus# configure terminal
awplus(config)# spanning-tree cisco-interoperability enable
```

To disable Cisco interoperability on a Layer 2 device:

```
awplus# configure terminal
awplus(config)# spanning-tree cisco-interoperability disable
```

spanning-tree edgeport (RSTP and MSTP)

Overview Use this command to set a port as an edge-port.

Use this command for RSTP or MSTP.

This command has the same effect as the [spanning-tree portfast \(STP\)](#) command, but the configuration displays differently in the output of some show commands.

Use the **no** variant of this command to set a port to its default state (not an edge-port).

Syntax `spanning-tree edgeport`
`no spanning-tree edgeport`

Default Not an edge port.

Mode Interface Configuration

Usage notes Use this command on a switch port connected to a LAN that has no other bridges attached. If a BPDU is received on the port that indicates that another bridge is connected to the LAN, then the port is no longer treated as an edge port.

Example `awplus# configure terminal`
`awplus(config)# interface port1.0.2`
`awplus(config-if)# spanning-tree edgeport`

Related commands [spanning-tree autoedge \(RSTP and MSTP\)](#)

spanning-tree enable

Overview Use this command in Global Configuration mode to enable the specified spanning tree protocol for all switch ports. Note that this must be the spanning tree protocol that is configured on the device by the [spanning-tree mode](#) command.

Use the **no** variant of this command to disable the configured spanning tree protocol. This places all switch ports in the forwarding state.

Syntax `spanning-tree {mstp|rstp|stp} enable`
`no spanning-tree {mstp|rstp|stp} enable`

Parameter	Description
mstp	Enables or disables MSTP (Multiple Spanning Tree Protocol).
rstp	Enables or disables RSTP (Rapid Spanning Tree Protocol).
stp	Enables or disables STP (Spanning Tree Protocol).

Default RSTP is enabled by default for all switch ports.

Mode Global Configuration

Usage With no configuration, spanning tree is enabled, and the spanning tree mode is set to RSTP. To change the mode, see [spanning-tree mode](#) command.

Examples To enable STP in Global Configuration mode, enter the below commands:

```
awplus# configure terminal
awplus(config)# spanning-tree stp enable
```

To disable STP in Global Configuration mode, enter the below commands:

```
awplus# configure terminal
awplus(config)# no spanning-tree stp enable
```

To enable MSTP in Global Configuration mode, enter the below commands:

```
awplus# configure terminal
awplus(config)# spanning-tree mstp enable
```

To disable MSTP in Global Configuration mode, enter the below commands:

```
awplus# configure terminal
awplus(config)# no spanning-tree mstp enable
```

To enable RSTP in Global Configuration mode, enter the below commands:

```
awplus# configure terminal
awplus(config)# spanning-tree rstp enable
```

To disable RSTP in Global Configuration mode, enter the below commands:

```
awplus# configure terminal
```

```
awplus(config)# no spanning-tree rstp enable
```

Related commands [spanning-tree mode](#)

spanning-tree errdisable-timeout enable

Overview Use this command to enable the errdisable-timeout facility, which sets a timeout for ports that are disabled due to the BPDU guard feature.

Use this command for RSTP or MSTP.

Use the **no** variant of this command to disable the errdisable-timeout facility.

Syntax `spanning-tree errdisable-timeout enable`
`no spanning-tree errdisable-timeout enable`

Default By default, the errdisable-timeout is disabled.

Mode Global Configuration

Usage The BPDU guard feature shuts down the port on receiving a BPDU on a BPDU-guard enabled port. This command associates a timer with the feature such that the port is re-enabled without manual intervention after a set interval. This interval can be configured by the user using the [spanning-tree errdisable-timeout interval](#) command.

Example `awplus# configure terminal`
`awplus(config)# spanning-tree errdisable-timeout enable`

Related commands [show spanning-tree](#)
[spanning-tree errdisable-timeout interval](#)
[spanning-tree portfast bpdu-guard](#)

spanning-tree errdisable-timeout interval

Overview Use this command to specify the time interval after which a port is brought back up when it has been disabled by the BPDU guard feature.

Use this command for RSTP or MSTP.

Syntax `spanning-tree errdisable-timeout interval <10-1000000>`
`no spanning-tree errdisable-timeout interval`

Parameter	Description
<code><10-1000000></code>	Specify the errdisable-timeout interval in seconds.

Default By default, the port is re-enabled after 300 seconds.

Mode Global Configuration

Example `awplus# configure terminal`
`awplus(config)# spanning-tree errdisable-timeout interval 34`

Related commands [show spanning-tree](#)
[spanning-tree errdisable-timeout enable](#)
[spanning-tree portfast bpdu-guard](#)

spanning-tree force-version

Overview Use this command in Interface Configuration mode for a switch port interface only to force the protocol version for the switch port. Use this command for RSTP or MSTP only.

Syntax `spanning-tree force-version <version>`
`no spanning-tree force-version`

Parameter	Description
<code><version></code>	<code><0-3></code> Version identifier.
0	Forces the port to operate in STP mode.
1	Not supported.
2	Forces the port to operate in RSTP mode. If it receives STP BPDUs, it can automatically revert to STP mode.
3	Forces the port to operate in MSTP mode (this option is only available if MSTP mode is configured). If it receives RSTP or STP BPDUs, it can automatically revert to RSTP or STP mode.

Default By default, no version is forced for the port. The port is in the spanning tree mode configured for the device, or a lower version if it automatically detects one.

Mode Interface Configuration mode for a switch port interface only.

Examples Set the value to enforce the spanning tree protocol (STP):

```
awplus# configure terminal
awplus(config)# interface port1.0.2
awplus(config-if)# spanning-tree force-version 0
```

Set the default protocol version:

```
awplus# configure terminal
awplus(config)# interface port1.0.2
awplus(config-if)# no spanning-tree force-version
```

Related commands [show spanning-tree](#)

spanning-tree forward-time

Overview Use this command to set the forward delay value. Use the **no** variant of this command to reset the forward delay value to the default setting of 15 seconds.

The **forward delay** sets the time (in seconds) to control how fast a port changes its spanning tree state when moving towards the forwarding state. If the mode is set to STP, the value determines how long the port stays in each of the listening and learning states which precede the forwarding state. If the mode is set to RSTP or MSTP, this value determines the maximum time taken to transition from discarding to learning and from learning to forwarding.

This value is used only when the device is acting as the root bridge. Devices not acting as the Root Bridge use a dynamic value for the **forward delay** set by the root bridge. The **forward delay**, **max-age**, and **hello time** parameters are interrelated.

Syntax `spanning-tree forward-time <forward-delay>`
`no spanning-tree forward-time`

Parameter	Description
<code><forward-delay></code>	<code><4-30></code> The forwarding time delay in seconds.

Default The default is 15 seconds.

Mode Global Configuration

Usage notes The allowable range for forward-time is 4-30 seconds.

The **forward delay**, **max-age**, and **hello time** parameters should be set according to the following formula, as specified in IEEE Standard 802.1d:

$2 \times (\text{forward delay} - 1.0 \text{ seconds}) \geq \text{max-age}$

$\text{max-age} \geq 2 \times (\text{hello time} + 1.0 \text{ seconds})$

Example

```
awplus# configure terminal
awplus(config)# spanning-tree forward-time 6
```

Related commands [show spanning-tree](#)
[spanning-tree forward-time](#)
[spanning-tree hello-time](#)
[spanning-tree mode](#)

spanning-tree guard root

Overview Use this command in Interface Configuration mode for a switch port only to enable the Root Guard feature for the switch port. The root guard feature disables reception of superior BPDUs. You can use this command for RSTP, STP or MSTP.

Use the **no** variant of this command to disable the root guard feature for the port.

Syntax `spanning-tree guard root`
`no spanning-tree guard root`

Mode Interface Configuration mode for a switch port interface only.

Usage notes The Root Guard feature makes sure that the port on which it is enabled is a designated port. If the Root Guard enabled port receives a superior BPDU, it goes to a Listening state (for STP) or discarding state (for RSTP and MSTP).

Example `awplus# configure terminal`
`awplus(config)# interface port1.0.2`
`awplus(config-if)# spanning-tree guard root`

spanning-tree hello-time

Overview Use this command to set the hello-time. This sets the time in seconds between the transmission of device spanning tree configuration information when the device is the Root Bridge of the spanning tree or is trying to become the Root Bridge.

Use this command for RSTP, STP or MSTP.

Use the **no** variant of this command to restore the default of the hello time.

Syntax `spanning-tree hello-time <hello-time>`
`no spanning-tree hello-time`

Parameter	Description
<code><hello-time></code>	<code><1-10></code> The hello BPDU interval in seconds.

Default Default is 2 seconds.

Mode Global Configuration and Interface Configuration for switch ports.

Usage notes The allowable range of values is 1-10 seconds.

The forward delay, max-age, and hello time parameters should be set according to the following formula, as specified in IEEE Standard 802.1d:

$2 \times (\text{forward delay} - 1.0 \text{ seconds}) \geq \text{max-age}$

$\text{max-age} \geq 2 \times (\text{hello time} + 1.0 \text{ seconds})$

Example `awplus# configure terminal`
`awplus(config)# spanning-tree hello-time 3`

Related commands [spanning-tree forward-time](#)
[spanning-tree max-age](#)
[show spanning-tree](#)

spanning-tree link-type

Overview Use this command in Interface Configuration mode for a switch port interface only to enable or disable point-to-point or shared link types on the switch port.

Use this command for RSTP or MSTP only.

Use the **no** variant of this command to return the port to the default link type.

Syntax `spanning-tree link-type {point-to-point|shared}`
`no spanning-tree link-type`

Parameter	Description
shared	Disable rapid transition.
point-to-point	Enable rapid transition.

Default The default link type is point-to-point.

Mode Interface Configuration mode for a switch port interface only.

Usage notes You may want to set link type to shared if the port is connected to a hub with multiple devices connected to it.

Examples `awplus# configure terminal`
`awplus(config)# interface port1.0.2`
`awplus(config-if)# spanning-tree link-type point-to-point`

spanning-tree max-age

Overview Use this command to set the max-age. This sets the maximum age, in seconds, that dynamic spanning tree configuration information is stored in the device before it is discarded.

Use this command for RSTP, STP or MSTP.

Use the **no** variant of this command to restore the default of max-age.

Syntax `spanning-tree max-age <max-age>`
`no spanning-tree max-age`

Parameter	Description
<code><max-age></code>	<code><6-40></code> The maximum time, in seconds.

Default The default of spanning-tree max-age is 20 seconds.

Mode Global Configuration

Usage Max-age is the maximum time in seconds for which a message is considered valid. Configure this value sufficiently high, so that a frame generated by the root bridge can be propagated to the leaf nodes without exceeding the max-age.

The **forward delay**, **max-age**, and **hello time** parameters should be set according to the following formula, as specified in IEEE Standard 802.1d:

$2 \times (\text{forward delay} - 1.0 \text{ seconds}) \geq \text{max-age}$

$\text{max-age} \geq 2 \times (\text{hello time} + 1.0 \text{ seconds})$

Example `awplus# configure terminal`
`awplus(config)# spanning-tree max-age 12`

Related commands [show spanning-tree](#)
[spanning-tree forward-time](#)
[spanning-tree hello-time](#)

spanning-tree max-hops (MSTP)

Overview Use this command to specify the maximum allowed hops for a BPDU in an MST region. This parameter is used by all the instances of the MST region.

Use the **no** variant of this command to restore the default.

Use this command for MSTP only.

Syntax `spanning-tree max-hops <hop-count>`
`no spanning-tree max-hops <hop-count>`

Parameter	Description
<code><hop-count></code>	Specify the maximum hops the BPDU will be valid for in the range <1-40>.

Default The default max-hops in a MST region is 20.

Mode Global Configuration

Usage Specifying the max hops for a BPDU prevents the messages from looping indefinitely in the network. The hop count is decremented by each receiving port. When a device receives an MST BPDU that has a hop count of zero, it discards the BPDU.

Examples `awplus# configure terminal`
`awplus(config)# spanning-tree max-hops 25`
`awplus# configure terminal`
`awplus(config)# no spanning-tree max-hops`

spanning-tree mode

Overview Use this command to change the spanning tree protocol mode on the device. The spanning tree protocol mode on the device can be configured to either STP, RSTP or MSTP.

Syntax `spanning-tree mode {stp|rstp|mstp}`

Default The default spanning tree protocol mode on the device is RSTP.

Mode Global Configuration

Usage With no configuration, the device will have spanning tree enabled, and the spanning tree mode will be set to RSTP. Use this command to change the spanning tree protocol mode on the device. MSTP is VLAN aware, but RSTP and STP are not VLAN aware. To enable or disable spanning tree operation, see the [spanning-tree enable](#) command.

Examples To change the spanning tree mode from the default of RSTP to MSTP, use the following commands:

```
awplus# configure terminal
awplus(config)# spanning-tree mode mstp
```

Related commands [spanning-tree enable](#)

spanning-tree mst configuration

Overview Use this command to enter the MST Configuration mode to configure the Multiple Spanning-Tree Protocol.

Syntax `spanning-tree mst configuration`

Mode Global Configuration

Examples The following example uses this command to enter MST Configuration mode. Note the change in the command prompt.

```
awplus# configure terminal
awplus(config)# spanning-tree mst configuration
awplus(config-mst)#
```

spanning-tree mst instance

Overview Use this command to assign a Multiple Spanning Tree instance (MSTI) to a switch port or channel group.

Note that ports are automatically configured to send and receive spanning-tree information for the associated MSTI when VLANs are assigned to MSTIs using the [instance vlan \(MSTP\)](#) command.

Use the **no** variant of this command in Interface Configuration mode to remove the MSTI from the specified switch port or channel group.

Syntax

```
spanning-tree mst instance <instance-id>  
no spanning-tree mst instance <instance-id>
```

Parameter	Description
<instance-id>	Specify an MSTP instance in the range 1-5. The MST instance must have already been created using the instance vlan (MSTP) command.

Default A port automatically becomes a member of an MSTI when it is assigned to a VLAN.

Mode Interface Configuration mode for a switch port or channel group.

Usage notes You can disable automatic configuration of member ports of a VLAN to an associated MSTI by using a **no spanning-tree mst instance** command to remove the member port from the MSTI. Use the **spanning-tree mst instance** command to add a VLAN member port back to the MSTI.

Examples To assign instance 3 to a switch port, use the commands:

```
awplus# configure terminal  
awplus(config)# interface port1.0.2  
awplus(config-if)# spanning-tree mst instance 3
```

To remove instance 3 from a switch port, use the commands:

```
awplus# configure terminal  
awplus(config)# interface port1.0.2  
awplus(config-if)# no spanning-tree mst instance 3
```

Related commands

- [instance vlan \(MSTP\)](#)
- [spanning-tree mst instance path-cost](#)
- [spanning-tree mst instance priority](#)
- [spanning-tree mst instance restricted-role](#)
- [spanning-tree mst instance restricted-tcn](#)

spanning-tree mst instance path-cost

Overview Use this command to set the cost of a path associated with a switch port, for the specified MSTI.

This specifies the switch port's contribution to the cost of a path to the MSTI regional root via that port. This applies when the port is the root port for the MSTI.

Use the **no** variant of this command to restore the default cost value of the path.

Syntax `spanning-tree mst instance <instance-id> path-cost <path-cost>`
`no spanning-tree mst instance <instance-id> path-cost`

Parameter	Description
<code><instance-id></code>	Specify an MSTP instance in the range 1-5.
<code><path-cost></code>	Specify the cost of path in the range of <1-200000000>, where a lower path-cost indicates a greater likelihood of the specific interface becoming a root.

Default The default path cost values and the range of recommended path cost values depend on the port speed, as shown in the following table from the IEEE 802.1q-2003 standard.

Port speed	Default path cost	Recommended path cost range
Less than 100 Kb/s	200,000,000	20,000,000-200,000,000
1Mbps	20,000,000	2,000,000-20,000,000
10Mbps	2,000,000	200,000-2,000,000
100 Mbps	200,000	20,000-200,000
1 Gbps	20,000	2,000-20,000
10 Gbps	2,000	200-2,000
100 Gbps	200	20-200
1Tbps	20	2-200
10 Tbps	2	2-20

Mode Interface Configuration mode for a switch port interface only.

Usage notes Before you can use this command to set a path-cost in a VLAN configuration, you must explicitly add an MST instance to a port using the [spanning-tree mst instance](#) command.

Examples To set a path cost of 1000 on instance 3, use the commands:

```
awplus# configure terminal
awplus(config)# interface port1.0.2
awplus(config-if)# spanning-tree mst instance 3 path-cost 1000
```

To return the path cost to its default value on instance 3, use the commands:

```
awplus# configure terminal
awplus(config)# interface port1.0.2
awplus(config-if)# no spanning-tree mst instance 3 path-cost
```

**Related
commands**

[instance vlan \(MSTP\)](#)
[spanning-tree mst instance](#)
[spanning-tree mst instance priority](#)
[spanning-tree mst instance restricted-role](#)
[spanning-tree mst instance restricted-tcn](#)

spanning-tree mst instance priority

Overview Use this command in Interface Configuration mode for a switch port interface only to set the port priority for an MST instance (MSTI).

Use the **no** variant of this command to restore the default priority value (128).

Syntax `spanning-tree mst instance <instance-id> priority <priority>`
`no spanning-tree mst instance <instance-id> [priority]`

Parameter	Description
<code><instance-id></code>	Specify an MSTP instance in the range 1-5.
<code><priority></code>	This must be a multiple of 16 and within the range <0-240>. A lower priority indicates greater likelihood of the port becoming the root port.

Default The default is 128.

Mode Interface Configuration mode for a switch port interface.

Usage notes This command sets the value of the priority field contained in the port identifier. The MST algorithm uses the port priority when determining the root port for the switch in the MSTI. The port with the lowest value has the highest priority, so it will be chosen as root port over a port that is equivalent in all other aspects but with a higher priority value.

Examples To set the priority to 112 on instance 3, use the commands:

```
awplus# configure terminal
awplus(config)# interface port1.0.2
awplus(config-if)# spanning-tree mst instance 3 priority 112
```

To return the priority to its default value of 128 on instance 3, use the commands:

```
awplus# configure terminal
awplus(config)# interface port1.0.2
awplus(config-if)# no spanning-tree mst instance 3 priority
```

Related commands

- [instance vlan \(MSTP\)](#)
- [spanning-tree priority \(port priority\)](#)
- [spanning-tree mst instance](#)
- [spanning-tree mst instance path-cost](#)
- [spanning-tree mst instance restricted-role](#)
- [spanning-tree mst instance restricted-tcn](#)

spanning-tree mst instance restricted-role

Overview Use this command in Interface Configuration mode for a switch port interface only to enable the restricted role for an MSTI (Multiple Spanning Tree Instance) on a switch port. Configuring the restricted role for an MSTI on a switch port prevents the switch port from becoming the root port in a spanning tree topology.

Use the **no** variant of this command to disable the restricted role for an MSTI on a switch port. Removing the restricted role for an MSTI on a switch port allows the switch port to become the root port in a spanning tree topology.

Syntax `spanning-tree mst instance <instance-id> restricted-role`
`no spanning-tree mst instance <instance-id> restricted-role`

Parameter	Description
<code><instance-id></code>	Specify an MSTP instance in the range 1-5. The MST instance must have already been created using the instance vlan (MSTP) command.

Default The restricted role for an MSTI instance on a switch port is disabled by default.

Mode Interface Configuration mode for a switch port interface only.

Usage notes The root port is the port providing the best path from the bridge to the root bridge. Use this command to disable a port from becoming a root port. Use the **no** variant of this command to enable a port to become a root port. See the [STP Feature Overview and Configuration Guide](#) for root port information.

Examples To prevent a switch port from becoming the root port, use the commands:

```
awplus# configure terminal
awplus(config)# interface port1.0.2
awplus(config-if)# spanning-tree mst instance 3 restricted-role
```

To stop preventing the switch port from becoming the root port, use the commands:

```
awplus# configure terminal
awplus(config)# interface port1.0.2
awplus(config-if)# no spanning-tree mst instance 3
restricted-role
```

Related commands

- instance vlan (MSTP)
- spanning-tree priority (port priority)
- spanning-tree mst instance
- spanning-tree mst instance path-cost
- spanning-tree mst instance restricted-tcn

spanning-tree mst instance restricted-tcn

Overview Use this command to prevent a switch port from propagating received topology change notifications and topology changes to other switch ports. This is named restricted TCN (Topology Change Notification). A TCN is a simple Bridge Protocol Data Unit (BPDU) that a bridge sends out to its root port to signal a topology change.

Use the **no** variant of this command to stop preventing the switch port from propagating received topology change notifications and topology changes to other switch ports for the specified MSTI (Multiple Spanning Tree Instance).

The restricted TCN setting applies only to the specified MSTI (Multiple Spanning Tree Instance).

Syntax `spanning-tree mst instance <instance-id> restricted-tcn`
`no spanning-tree mst instance <instance-id> restricted-tcn`

Parameter	Description
<code><instance-id></code>	Specify an MSTP instance in the range 1-5. The MST instance must have already been created using the instance vlan (MSTP) command.

Default Disabled. By default, switch ports propagate TCNs.

Mode Interface Configuration mode for a switch port interface only.

Examples To prevent a switch port from propagating received topology change notifications and topology changes to other switch ports, use the commands:

```
awplus# configure terminal
awplus(config)# interface port1.0.2
awplus(config-if)# spanning-tree mst instance 3 restricted-tcn
```

To stop preventing a switch port from propagating received topology change notifications and topology changes to other switch ports, use the commands:

```
awplus# configure terminal
awplus(config)# interface port1.0.2
awplus(config-if)# no spanning-tree mst instance 3
restricted-tcn
```

Related commands

- [instance vlan \(MSTP\)](#)
- [spanning-tree priority \(port priority\)](#)
- [spanning-tree mst instance](#)
- [spanning-tree mst instance path-cost](#)
- [spanning-tree mst instance restricted-role](#)

spanning-tree path-cost

Overview Use this command in Interface Configuration mode for a switch port interface only to set the cost of a path for the specified port. This value then combines with others along the path to the root bridge in order to determine the total cost path value from the particular port, to the root bridge. The lower the numeric value, the higher the priority of the path. This applies when the port is the root port.

Use this command for RSTP, STP or MSTP. When MSTP mode is configured, this will apply to the port's path cost for the CIST.

Syntax `spanning-tree path-cost <pathcost>`
`no spanning-tree path-cost`

Parameter	Description
<code><pathcost></code>	<code><1-200000000></code> The cost to be assigned to the port.

Default The default path cost values and the range of recommended path cost values depend on the port speed, as shown in the following table from the IEEE 802.1q-2003 and IEEE 802.1d-2004 standards.

Port speed	Default path cost	Recommended path cost range
Less than 100 Kb/s	200,000,000	20,000,000-200,000,000
1Mbps	20,000,000	2,000,000-20,000,000
10Mbps	2,000,000	200,000-2,000,000
100 Mbps	200,000	20,000-200,000
1 Gbps	20,000	2,000-20,000
10 Gbps	2,000	200-2,000
100 Gbps	200	20-200
1Tbps	20	2-200
10 Tbps	2	2-20

Mode Interface Configuration mode for switch port interface only.

Example `awplus# configure terminal`
`awplus(config)# interface port1.0.2`
`awplus(config-if)# spanning-tree path-cost 123`

spanning-tree portfast (STP)

Overview Use this command in Interface Configuration mode for a switch port interface only to set a port as an edge-port. The portfast feature enables a port to rapidly move to the forwarding state, without having first to pass through the intermediate spanning tree states. This command has the same effect as the [spanning-tree edgeport \(RSTP and MSTP\)](#) command, but the configuration displays differently in the output of some show commands.

NOTE: You can run either of two additional parameters with this command. To simplify the syntax these are documented as separate commands. See the following additional portfast commands:

- [spanning-tree portfast bpdu-filter](#) command
- [spanning-tree portfast bpdu-guard](#) command.

You can obtain the same effect by running the [spanning-tree edgeport \(RSTP and MSTP\)](#) command. However, the configuration output may display differently in some show commands.

Use the **no** variant of this command to set a port to its default state (not an edge-port).

Syntax `spanning-tree portfast`
`no spanning-tree portfast`

Default Not an edge port.

Mode Interface Configuration mode for a switch port interface only.

Usage notes Portfast makes a port move from a blocking state to a forwarding state, bypassing both listening and learning states. The portfast feature is meant to be used for ports connected to end-user devices. Enabling portfast on ports that are connected to a workstation or server allows devices to connect to the network without waiting for spanning-tree to converge.

For example, you may need hosts to receive a DHCP address quickly and waiting for STP to converge would cause the DHCP request to time out. Ensure you do not use portfast on any ports connected to another device to avoid creating a spanning-tree loop on the network.

Use this command on a switch port that connects to a LAN with no other bridges attached. An edge port should never receive BPDUs. Therefore if an edge port receives a BPDU, the portfast feature takes one of three actions.

- Cease to act as an edge port and pass BPDUs as a member of a spanning tree network ([spanning-tree portfast \(STP\)](#) command disabled).
- Filter out the BPDUs and pass only the data and continue to act as a edge port ([spanning-tree portfast bpdu-filter](#) command enabled).
- Block the port to all BPDUs and data ([spanning-tree portfast bpdu-guard](#) command enabled).

Example awplus# configure terminal
awplus(config)# interface port1.0.2
awplus(config-if)# spanning-tree portfast

Related commands spanning-tree edgeport (RSTP and MSTP)
show spanning-tree
spanning-tree portfast bpdu-filter
spanning-tree portfast bpdu-guard

spanning-tree portfast bpdu-filter

Overview This command sets the bpdu-filter feature and applies a filter to any BPDUs (Bridge Protocol Data Units) received. Enabling this feature ensures that configured ports will not transmit any BPDUs and will ignore (filter out) any BPDUs received. BPDU Filter is not enabled on a port by default.

Using the **no** variant of this command to turn off the bpdu-filter, but retain the port's status as an enabled port. If the port then receives a BPDU it will change its role from an **edge-port** to a **non edge-port**.

Syntax (Global Configuration)

```
spanning-tree portfast bpdu-filter  
no spanning-tree portfast bpdu-filter
```

Syntax (Interface Configuration)

```
spanning-tree portfast bpdu-filter  
{default|disable|enable}  
no spanning-tree portfast bpdu-filter
```

Parameter	Description
bpdu-filter	A port that has bpdu-filter enabled will not transmit any BPDUs and will ignore any BPDUs received. This port type has one of the following parameters (in Interface Configuration mode):
default	Takes the setting that has been configured for the whole device, i.e. the setting made from the Global configuration mode.
disable	Turns off BPDU filter.
enable	Turns on BPDU filter.

Default BPDU Filter is not enabled on any ports by default.

Mode Global Configuration and Interface Configuration

Usage notes This command filters the BPDUs and passes only data to continue to act as an edge port. Using this command in Global Configuration mode applies the portfast bpdu-filter feature to all ports on the device. Using it in Interface mode applies the feature to a specific port, or range of ports. The command will operate in both RSTP and MSTP networks.

Use the [show spanning-tree](#) command to display status of the bpdu-filter parameter for the switch ports.

Example To enable STP BPDU filtering in Global Configuration mode, enter the commands:

```
awplus# configure terminal  
awplus(config)# spanning-tree portfast bpdu-filter
```

To enable STP BPDU filtering in Interface Configuration mode, enter the commands:

```
awplus# configure terminal
awplus(config)# interface port1.0.2
awplus(config-if)# spanning-tree portfast bpdu-filter enable
```

**Related
commands**

[spanning-tree edgeport \(RSTP and MSTP\)](#)
[show spanning-tree](#)
[spanning-tree portfast \(STP\)](#)
[spanning-tree portfast bpdu-guard](#)

spanning-tree portfast bpdu-guard

Overview The AR3050S and AR4050S devices don't support BPDU protection in 5.4.5-0.1 release.

This command applies a BPDU (Bridge Protocol Data Unit) guard to the port. A port with the bpdu-guard feature enabled will block all traffic (BPDUs and user data), if it starts receiving BPDUs.

Use this command in Global Configuration mode to apply BPDU guard to all ports on the device. Use this command in Interface mode for an individual interface or a range of interfaces specified. BPDU Guard is not enabled on a port by default.

Use the **no** variant of this command to disable the BPDU Guard feature on a device in Global Configuration mode or to disable the BPDU Guard feature on a port in Interface mode.

Syntax (Global Configuration)

```
spanning-tree portfast bpdu-guard  
no spanning-tree portfast bpdu-guard
```

Syntax (Interface Configuration)

```
spanning-tree portfast bpdu-guard  
{default|disable|enable}  
no spanning-tree portfast bpdu-guard
```

Parameter	Description
bpdu-guard	A port that has bpdu-guard turned on will enter the STP blocking state if it receives a BPDU. This port type has one of the following parameters (in Interface Configuration mode):
default	Takes the setting that has been configured for the whole device, i.e. the setting made from the Global configuration mode.
disable	Turns off BPDU guard.
enable	Turns on BPDU guard and will also set the port as an edge port.

Default BPDU Guard is not enabled on any ports by default.

Mode Global Configuration or Interface Configuration

Usage notes This command blocks the port(s) to all devices and data when enabled. BPDU Guard is a port-security feature that changes how a portfast-enabled port behaves if it receives a BPDU. When **bpdu-guard** is set, then the port shuts down if it receives a BPDU. It does not process the BPDU as it is considered suspicious. When **bpdu-guard** is not set, then the port will negotiate spanning-tree with the device sending the BPDUs. By default, bpdu-guard is not enabled on a port.

You can configure a port disabled by the bpdu-guard to re-enable itself after a specific time interval. This interval is set with the [spanning-tree errdisable-timeout](#)

`interval` command. If you do not use the **errdisable-timeout** feature, then you will need to manually re-enable the port by using the **no shutdown** command.

Use the `show spanning-tree` command to display the device and port configurations for the BPDU Guard feature. It shows both the administratively configured and currently running values of `bpdu-guard`.

Example To enable STP BPDU guard in Global Configuration mode, enter the below commands:

```
awplus# configure terminal
awplus(config)# spanning-tree portfast bpdu-guard
```

To enable STP BPDU guard in Interface Configuration mode, enter the below commands:

```
awplus# configure terminal
awplus(config)# interface port1.0.2
awplus(config-if)# spanning-tree portfast bpdu-guard enable
```

Related commands

- `spanning-tree edgeport (RSTP and MSTP)`
- `show spanning-tree`
- `spanning-tree portfast (STP)`
- `spanning-tree portfast bpdu-filter`

spanning-tree priority (bridge priority)

Overview Use this command to set the bridge priority for the device. A lower priority value indicates a greater likelihood of the device becoming the root bridge.

Use this command for RSTP, STP or MSTP. When MSTP mode is configured, this will apply to the CIST.

Use the **no** variant of this command to reset it to the default.

Syntax `spanning-tree priority <priority>`
`no spanning-tree priority`

Parameter	Description
<code><priority></code>	<code><0-61440></code> The bridge priority, which will be rounded to a multiple of 4096.

Default The default priority is 32678.

Mode Global Configuration

Usage To force a particular device to become the root bridge use a lower value than other devices in the spanning tree.

Example `awplus# configure terminal`
`awplus(config)# spanning-tree priority 4096`

Related commands [spanning-tree mst instance priority](#)
[show spanning-tree](#)

spanning-tree priority (port priority)

Overview Use this command in Interface Configuration mode for a switch port interface only to set the port priority for port. A lower priority value indicates a greater likelihood of the port becoming part of the active topology.

Use this command for RSTP, STP, or MSTP. When the device is in MSTP mode, this will apply to the CIST.

Use the **no** variant of this command to reset it to the default.

Syntax `spanning-tree priority <priority>`
`no spanning-tree priority`

Parameter	Description
<code><priority></code>	<code><0-240></code> , in increments of 16. The port priority, which will be rounded down to a multiple of 16.

Default The default priority is 128.

Mode Interface Configuration mode for a switch port interface only.

Usage notes To force a port to be part of the active topology (for instance, become the root port or a designated port) use a lower value than other ports on the device. (This behavior is subject to network topology, and more significant factors, such as bridge ID.)

Example

```
awplus# configure terminal
awplus(config)# interface port1.0.2
awplus(config-if)# spanning-tree priority 16
```

Related commands

- [spanning-tree mst instance priority](#)
- [spanning-tree priority \(bridge priority\)](#)
- [show spanning-tree](#)

spanning-tree restricted-role

Overview Use this command in Interface Configuration mode for a switch port interface only to restrict the port from becoming a root port.

Use the **no** variant of this command to disable the restricted role functionality.

Syntax `spanning-tree restricted-role`
`no spanning-tree restricted-role`

Default The restricted role is disabled.

Mode Interface Configuration mode for a switch port interface only.

Example

```
awplus# configure terminal
awplus(config)# interface port1.0.2
awplus(config-if)# spanning-tree restricted-role
```

spanning-tree restricted-tcn

Overview Use this command in Interface Configuration mode for a switch port interface only to prevent TCN (Topology Change Notification) BPDUs (Bridge Protocol Data Units) from being sent on a port. If this command is enabled, after a topology change a bridge is prevented from sending a TCN to its designated bridge.

Use the **no** variant of this command to disable the restricted TCN functionality.

Syntax `spanning-tree restricted-tcn`
`no spanning-tree restricted-tcn`

Default The restricted TCN is disabled.

Mode Interface Configuration mode for a switch port interface only.

Example `awplus# configure terminal`
`awplus(config)# interface port1.0.2`
`awplus(config-if)# spanning-tree restricted-tcn`

spanning-tree transmit-holdcount

Overview Use this command to set the maximum number of BPDU transmissions that are held back.

Use the **no** variant of this command to restore the default transmit hold-count value.

Syntax `spanning-tree transmit-holdcount`
`no spanning-tree transmit-holdcount`

Default Transmit hold-count default is 3.

Mode Global Configuration

Example `awplus# configure terminal`
`awplus(config)# spanning-tree transmit-holdcount`

undebbug mstp

Overview This command applies the functionality of the no `debug mstp` (RSTP and STP) command.

17

Link Aggregation Commands

Introduction

Overview This chapter provides an alphabetical reference of commands used to configure a static channel group (static aggregator) and dynamic channel group (LACP channel group, etherchannel or LACP aggregator). Link aggregation is also sometimes referred to as channeling.

NOTE: *AlliedWare Plus™ supports IEEE 802.3ad link aggregation and uses the Link Aggregation Control Protocol (LACP). LACP does not interoperate with devices that use Port Aggregation Protocol (PAgP).*

Link aggregation does not necessarily achieve exact load balancing across the links. The load sharing algorithm is designed to ensure that any given data flow always goes down the same link. It also aims to spread data flows across the links as evenly as possible.

For example, for a 2 Gbps LAG that is a combination of two 1 Gbps ports, any one flow of traffic can only ever reach a maximum throughput of 1 Gbps. However, the hashing algorithm should spread the flows across the links so that when many flows are operating, the full 2 Gbps can be utilized.

For a description of static and dynamic link aggregation (LACP), and configuration examples, see the [Link Aggregation Feature Overview and Configuration Guide](#).

- Command List**
- “channel-group” on page 640
 - “clear lacp counters” on page 642
 - “debug lacp” on page 643
 - “lacp global-passive-mode enable” on page 644
 - “lacp port-priority” on page 645
 - “lacp system-priority” on page 646
 - “lacp timeout” on page 647
 - “show debugging lacp” on page 649
 - “show diagnostic channel-group” on page 650

- [“show etherchannel”](#) on page 651
- [“show etherchannel detail”](#) on page 652
- [“show etherchannel summary”](#) on page 653
- [“show lacp sys-id”](#) on page 654
- [“show lacp-counter”](#) on page 655
- [“show port etherchannel”](#) on page 656
- [“show static-channel-group”](#) on page 657
- [“static-channel-group”](#) on page 658
- [“undebg lacp”](#) on page 660

channel-group

Overview Use this command to create a dynamic channel group, or to add a port to an existing dynamic channel group.

You can create up to 2 channel groups, in any combination of static and dynamic (LACP) groups. This means you can create up to 2 dynamic channel groups, if you have no static channel groups.

Use the **no** variant of this command to turn off link aggregation on the device port. You will be returned to Global Configuration mode from Interface Configuration mode.

Syntax `channel-group <dynamic-channel-group-number> mode {active|passive}`
`no channel-group`

Parameter	Description
<code><dynamic-channel-group-number></code>	<1-248> Dynamic channel group number for an LACP link. You can create up to 2 dynamic channel groups, numbered in the range 1-248.
<code>active</code>	Enables initiation of LACP negotiation on a port. The port will transmit LACP dialogue messages whether or not it receives them from the partner device.
<code>passive</code>	Disables initiation of LACP negotiation on a port. The port will only transmit LACP dialogue messages if the partner device is transmitting them, i.e., the partner is in the active mode.

Mode Interface Configuration

Usage notes All the device ports in a channel-group must belong to the same VLANs, have the same tagging status, and can only be operated on as a group. All device ports within a channel group must have the same port speed and be in full duplex mode.

Once the LACP channel group has been created, it is treated as a device port. You can specify it in other commands. If you are specifying it in:

- an LACP command, then use the channel-group number on its own. For example, use the command **show etherchannel 2** to show details about channel group 2.
- a non-LACP command, then use **po** followed by the channel-group number. For example, use the command **show interface po2** to show details about channel group 2's interface.

For more information about LACP, see the [Link Aggregation Feature Overview and Configuration Guide](#) which is available on our website at [alliedtelesis.com](#).

Examples To add device port1.0.2 to a newly created LACP channel group 2, in active mode, use the commands below:

```
awplus# configure terminal
awplus(config)# interface port1.0.2
awplus(config-if)# channel-group 2 mode active
```

To remove device port1.0.2 from any created LACP channel groups, use the command below:

```
awplus# configure terminal
awplus(config)# interface port1.0.2
awplus(config-if)# no channel-group
```

To reference channel group 2 as an interface, use the following commands:

```
awplus# configure terminal
awplus(config)# interface po2
awplus(config-if)#
```

Related commands

- [show etherchannel](#)
- [show etherchannel detail](#)
- [show etherchannel summary](#)
- [show port etherchannel](#)

Command changes Version 5.4.9-0.1: Ability added to create up to 2 groups as any combination of static and dynamic channel groups. Also, numbering changed to 1-248.

clear lacp counters

Overview Use this command to clear all counters of all present LACP aggregators (channel groups) or a given LACP aggregator.

Syntax `clear lacp [<1-248>] counters`

Parameter	Description
<1-248>	Channel-group number.

Mode Privileged Exec

Example `awplus# clear lacp 2 counters`

debug lacp

Overview Use this command to enable all LACP troubleshooting functions.

Use the **no** variant of this command to disable this function.

Syntax `debug lacp {all|cli|event|ha|packet|sync|timer[detail]}`
`no debug lacp {all|cli|event|ha|packet|sync|timer[detail]}`

Parameter	Description
all	Turn on all debugging for LACP.
cli	Specifies debugging for CLI messages. Echoes commands to the console.
event	Specifies debugging for LACP events. Echoes events to the console.
ha	Specifies debugging for HA (High Availability) events. Echoes High Availability events to the console.
packet	Specifies debugging for LACP packets. Echoes packet contents to the console.
sync	Specified debugging for LACP synchronization. Echoes synchronization to the console.
timer	Specifies debugging for LACP timer. Echoes timer expiry to the console.
detail	Optional parameter for LACP timer-detail. Echoes timer start/stop details to the console.

Mode Privileged Exec and Global Configuration

Examples `awplus# debug lacp timer detail`
`awplus# debug lacp all`

Related commands [show debugging lacp](#)
[undebug lacp](#)

lacp global-passive-mode enable

Overview Use this command to enable LACP channel-groups to dynamically self-configure when they are connected to another device that has LACP channel-groups configured with Active Mode.

Syntax lacp global-passive-mode enable
no lacp global-passive-mode enable

Default Enabled

Mode Global Configuration

Usage notes Do not mix LACP configurations (manual and dynamic). When LACP global passive mode is turned on (by using the **lacp global-passive-mode enable** command), we do not recommend using a mixed configuration in a LACP channel-group; i.e. some links are manually configured (by the **channel-group** command) and others are dynamically learned in the same channel-group.

Example To enable global passive mode for LACP channel groups, use the command:

```
awplus(config)# lacp global-passive-mode enable
```

To disable global passive mode for LACP channel groups, use the command:

```
awplus(config)# no lacp global-passive-mode enable
```

Related commands [show etherchannel](#)
[show etherchannel detail](#)

lacp port-priority

Overview Use this command to set the priority of a device port. Ports are selected for aggregation based on their priority, with the higher priority (numerically lower) ports selected first.

Use the **no** variant of this command to reset the priority of port to the default.

Syntax lacp port-priority <1-65535>
no lacp port-priority

Parameter	Description
<1-65535>	Specify the LACP port priority.

Default The default is 32768.

Mode Interface Configuration

Example awplus# configure terminal
awplus(config)# interface port1.0.2
awplus(config-if)# lacp port-priority 34

lacp system-priority

Overview Use this command to set the system priority of a local system. This is used in determining the system responsible for resolving conflicts in the choice of aggregation groups.

Use the **no** variant of this command to reset the system priority of the local system to the default.

Syntax lacp system-priority <1-65535>
no lacp system-priority

Parameter	Description
<1-65535>	LACP system priority. Lower numerical values have higher priorities.

Default The default is 32768.

Mode Global Configuration

Example awplus# configure terminal
awplus(config)# lacp system-priority 6700

lacp timeout

Overview Use this command to set the short or long timeout on a port. Ports will time out of the aggregation if three consecutive updates are lost.

Syntax lacp timeout {short|long}

Parameter	Description
timeout	Number of seconds before invalidating a received LACP data unit (DU).
short	LACP short timeout. The short timeout value is 1 second.
long	LACP long timeout. The long timeout value is 30 seconds.

Default The default is **long** timeout (30 seconds).

Mode Interface Configuration

Usage notes This command enables the device to indicate the rate at which it expects to receive LACPDUs from its neighbor.

If the timeout is set to **long**, then the device expects to receive an update every **30** seconds, and this will time a port out of the aggregation if no updates are seen for 90 seconds (i.e. 3 consecutive updates are lost).

If the timeout is set to **short**, then the device expects to receive an update every second, and this will time a port a port out of the aggregation if no updates are seen for 3 seconds (i.e. 3 consecutive updates are lost).

The device indicates its preference by means of the Timeout field in the Actor section of its LACPDUs. If the Timeout field is set to 1, then the device has set the **short** timeout. If the Timeout field is set to 0, then the device has set the **long** timeout.

Setting the **short** timeout enables the device to be more responsive to communication failure on a link, and does not add too much processing overhead to the device (1 packet per second).

NOTE: It is not possible to configure the rate that the device sends LACPDUs; the device must send at the rate which the neighbor indicates it expects to receive LACPDUs.

Examples The following commands set the LACP long timeout period for 30 seconds on port1.0.2.

```
awplus# configure terminal
awplus(config)# interface port1.0.2
awplus(config-if)# lacp timeout long
```

The following commands set the LACP short timeout for 1 second on port1.0.2.

```
awplus# configure terminal
awplus(config)# interface port1.0.2
awplus(config-if)# lacp timeout short
```

show debugging lacp

Overview Use this command to see what debugging is turned on for LACP management. For information on filtering and saving command output, see the [“Getting Started with AlliedWare Plus” Feature Overview and Configuration Guide](#).

Syntax `show debugging lacp`

Mode User Exec and Privileged Exec

Example `awplus# show debugging lacp`

Output Figure 17-1: Example output from the **show debugging lacp** command

```
LACP debugging status:
LACP timer debugging is on
LACP timer-detail debugging is on
LACP cli debugging is on
LACP packet debugging is on
LACP event debugging is on
LACP sync debugging is on
```

Related commands [debug lacp](#)

show diagnostic channel-group

Overview This command displays dynamic and static channel group interface status information. The output of this command is useful for Allied Telesis authorized service personnel for diagnostic purposes.

For information on filtering and saving command output, see the [“Getting Started with AlliedWare Plus” Feature Overview and Configuration Guide](#).

Syntax `show diagnostic channel-group`

Mode User Exec and Privileged Exec

Example `awplus# show diagnostic channel-group`

Output Figure 17-2: Example output from the **show diagnostic channel-group** command

```
awplus# show diagnostic channel-group

Channel Group Info based on NSM:
Note: Pos - position in hardware table
-----
Dev  Interface  IfIndex  Member port  IfIndex  Active  Pos
-----
    po1        4601     port1.0.4   5004        No
    po1        4601     port1.0.5   5005        No

Channel Group Info based on HSL:
Note: Pos - position in hardware table
-----
Dev  Interface  IfIndex  Member port  IfIndex  Active  Pos
-----
    po1        4601                                N/a

Channel Group Info based on IPIFWD:
Note: Pos - position in hardware table
-----
Dev  Interface  IfIndex  Member port  IfIndex  Active  Pos
-----
    po1        4601                                N/a

No error found
```

Related commands [show tech-support](#)

show etherchannel

Overview Use this command to display information about an LACP channel specified by the channel group number.

For information on filtering and saving command output, see the [“Getting Started with AlliedWare Plus” Feature Overview and Configuration Guide](#), which is available on our website at alliedtelesis.com.

Syntax show etherchannel [<1-248>]

Parameter	Description
<1-248>	Channel-group number.

Mode User Exec and Privileged Exec

Example awplus# show etherchannel

Output Figure 17-3: Example output from **show etherchannel**

```
awplus#show etherchannel
LAG Maximum      : 2
LAG Static Count : 0
LAG Dynamic Count : 1
LAG Total Count  : 1
Lacp Aggregator: pol
Member:
  port1.0.1
  port1.0.2
```

Example awplus# show etherchannel 1

Output Figure 17-4: Example output from **show etherchannel** for a particular channel

```
awplus#show etherchannel 1
Aggregator pol (4601)
  Mac address: 00:00:00:00:00:00
  Admin Key: 0001 - Oper Key 0000
  Receive link count: 0 - Transmit link count: 0
  Individual: 0 - Ready: 0
  Partner LAG: 0x0000,00-00-00-00-00-00
  Link: port1.0.1 (5001) disabled
  Link: port1.0.2 (5002) disabled
```

show etherchannel detail

Overview Use this command to display detailed information about all LACP channels. For information on filtering and saving command output, see the [“Getting Started with AlliedWare Plus” Feature Overview and Configuration Guide](#), which is available on our website at alliedtelesis.com.

Syntax `show etherchannel detail`

Mode User Exec and Privileged Exec

Example `awplus# show etherchannel detail`

Output Example output from **show etherchannel detail**

```
awplus#show etherchannel detail
Aggregator po1 (IfIndex: 4601)
  Mac address: 00:00:cd:37:05:17
  Admin Key: 0001 - Oper Key 0001
  Receive link count: 2 - Transmit link count: 2
  Individual: 0 - Ready: 1
  Partner LAG: 0x8000,00-00-cd-37-02-9a,0x0001
    Link: port1.0.1 (IfIndex: 8002) synchronized
    Link: port1.0.2 (IfIndex: 20002) synchronized
Aggregator po2 (IfIndex: 4602)
  Mac address: 00:00:cd:37:05:17
  Admin Key: 0002 - Oper Key 0002
  Receive link count: 2 - Transmit link count: 2
  Individual: 0 - Ready: 1
  Partner LAG: 0x8000,ec-cd-6d-aa-c8-56,0x0002
    Link: port1.0.3 (IfIndex: 8001) synchronized
    Link: port1.0.4 (IfIndex: 20001) synchronized
```

show etherchannel summary

Overview Use this command to display a summary of all LACP channels.

For information on filtering and saving command output, see the [“Getting Started with AlliedWare Plus” Feature Overview and Configuration Guide](#), which is available on our website at alliedtelesis.com.

Syntax `show etherchannel summary`

Mode User Exec and Privileged Exec

Example `awplus# show etherchannel summary`

Output Example output from **show etherchannel summary**

```
awplus#show etherchannel summary
Aggregator po10 (IfIndex: 4610)
Admin Key: 0010 - Oper Key 0010
  Link: port1.0.1 (IfIndex: 7007) synchronized
  Link: port1.0.2 (IfIndex: 8007) synchronized
  Link: port1.0.3 (IfIndex: 11007) synchronized
```

show lacp sys-id

Overview Use this command to display the LACP system ID and priority.

For information on filtering and saving command output, see the [“Getting Started with AlliedWare Plus” Feature Overview and Configuration Guide](#), which is available on our website at alliedtelesis.com.

Syntax `show lacp sys-id`

Mode User Exec and Privileged Exec

Example `awplus# show lacp sys-id`

Output Example output from **show lacp sys-id**

```
System Priority: 0x8000 (32768)
MAC Address: 0200.0034.5684
```

show lacp-counter

Overview Use this command to display the packet traffic on all ports of all present LACP aggregators, or a given LACP aggregator.

For information on filtering and saving command output, see the [“Getting Started with AlliedWare Plus” Feature Overview and Configuration Guide](#), which is available on our website at alliedtelesis.com.

Syntax `show lacp-counter [<1-248>]`

Parameter	Description
<1-248>	Channel-group number.

Mode User Exec and Privileged Exec

Example `awplus# show lacp-counter 2`

Output Example output from **show lacp-counter**

```
% Traffic statistics
Port          LACPDU      Marker      Pckt err
              Sent   Recv   Sent   Recv   Sent   Recv
% Aggregator po2 (IfIndex: 4604)
port1.0.2    0       0       0       0       0       0
```

show port etherchannel

Overview Use this command to show LACP details of the device port specified.

For information on filtering and saving command output, see the [“Getting Started with AlliedWare Plus” Feature Overview and Configuration Guide](#), which is available on our website at alliedtelesis.com.

Syntax `show port etherchannel <port>`

Parameter	Description
<code><port></code>	Name of the device port to display LACP information about.

Mode User Exec and Privileged Exec

Example `awplus# show port etherchannel port1.0.2`

Output Example output from **show port etherchannel**

```
awplus#show port etherchannel port1.0.2
LACP link info: port1.0.2 - 7007
Link: port1.0.2 (IfIndex: 7007)
Aggregator: po10 (IfIndex: 4610)
Receive machine state: Current
Periodic Transmission machine state: Slow periodic
Mux machine state: Collecting/Distributing
Actor Information:
Selected ..... Selected
Physical Admin Key ..... 2
Port Key ..... 10
Port Priority ..... 32768
Port Number ..... 7007
Mode ..... Active
Timeout ..... Long
Individual ..... Yes
Synchronised ..... Yes
Collecting ..... Yes
Distributing ..... Yes
Defaulted ..... No
Expired ..... No
Partner Information:
Partner Sys Priority ..... 0x8000
Partner System .. ec-cd-6d-d1-64-d0
Port Key ..... 10
Port Priority ..... 32768
Port Number ..... 5001
Mode ..... Active
Timeout ..... Long
Individual ..... Yes
Synchronised ..... Yes
Collecting ..... Yes
Distributing ..... Yes
Defaulted ..... No
Expired ..... No
```

show static-channel-group

Overview Use this command to display all configured static channel groups and their corresponding member ports. Note that a static channel group is the same as a static aggregator.

For information on filtering and saving command output, see the [“Getting Started with AlliedWare Plus” Feature Overview and Configuration Guide](#), which is available on our website at alliedtelesis.com.

Syntax `show static-channel-group`

Mode User Exec and Privileged Exec

Example `awplus# show static-channel-group`

Output Example output from **show static-channel-group**

```
% LAG Maximum      : 2
% LAG Static Count  : 2
% LAG Dynamic Count : 0
% LAG Total Count   : 2
% Static Aggregator: sa2
% Member:
  port1.0.1
port1.0.2
% Static Aggregator: sa3
% Member:
  port1.0.3
port1.0.4
```

Related commands [static-channel-group](#)

static-channel-group

Overview Use this command to create a static channel group, or to add a port to an existing static channel group. Static channel groups are also known as static aggregators.

You can create up to 2 channel groups, in any combination of static and dynamic (LACP) groups. This means you can create up to 2 static channel groups, if you have no dynamic channel groups.

Use the **no** variant of this command to remove the device port from the static channel group.

Syntax `static-channel-group <static-channel-group-number>`
`no static-channel-group`

Parameter	Description
<code><static-channel-group-number></code>	<1-248> Static channel group number. You can create up to 2 static channel groups, numbered in the range 1-248.

Mode Interface Configuration

Usage notes This command adds the device port to the static channel group with the specified channel group number. If the channel group does not exist, it is created, and the port is added to it. The **no** prefix detaches the port from the static channel group. If the port is the last member to be removed, the static channel group is deleted.

All the ports in a channel group must have the same VLAN configuration: they must belong to the same VLANs and have the same tagging status, and can only be operated on as a group.

Once the static channel group has been created, it is treated as a device port. You can specify it in other commands by using **sa** followed by the channel-group number. For example, use the command **show interface sa2** to show details about channel group 2's interface:

Examples To define static channel group 2 on port1.0.2, use the commands:

```
awplus# configure terminal
awplus(config)# interface port1.0.2
awplus(config-if)# static-channel-group 2
```

To reference static channel group 2 as an interface, use the commands:

```
awplus# configure terminal
awplus(config)# interface sa2
awplus(config-if)#
```

Related commands [show static-channel-group](#)

Command changes Version 5.4.9-0.1: Ability added to create up to 2 groups as any combination of static and dynamic channel groups. Also, numbering changed to 1-248.

undebbug lacp

Overview This command applies the functionality of the no `debug lacp` command.

18

802.1Q Encapsulation Commands

Introduction

Overview This chapter provides an alphabetical reference of commands used to configure 802.1Q Encapsulation. For more information, see the [Interface Feature Overview and Configuration Guide](#).

Command List • “encapsulation dot1q” on page 662

encapsulation dot1q

Overview Use this command to enable 802.1Q encapsulation on Ethernet interfaces, L2 tunnel interfaces (e.g. OpenVPN or L2TPv3 Ethernet pseudowire), or the VLAN-aware bridge 0.

Use the **no** variant of this command to disable 802.1Q encapsulation for the VLAN identified by the VLAN ID (VID).

Syntax `encapsulation dot1q <vid>`
`no encapsulation dot1q <vid>`

Parameter	Description
<code><vid></code>	Enter a VLAN ID in the range from 1 through 4094. The VLAN ID identifies the VLAN to which the frames belong. It also identifies the index of the subinterface of the Ethernet interface or Layer 2 tunnel interface.

Default 802.1Q encapsulation is disabled by default on all Ethernet interfaces, Layer 2 tunnel interfaces, and bridge interfaces.

Mode Interface Configuration

Usage notes You should enter the Ethernet interface or tunnel interface configuration mode to enable 802.1Q encapsulation and configure the VID first. Then you can use the VID to configure the sub-interface associated with the Ethernet interface or tunnel interface. Sub-interfaces are logical interfaces. The sub interface index must be the same as the VID. For example, if you configure VID 1 for eth1, then the sub-interface for eth1 is eth1.1. If you configure VID 2 for tunnel20, then the sub-interface for tunnel20 is tunnel20.2.

Examples To enable 802.1Q encapsulation on Ethernet interface eth1, use the commands:

```
awplus# configure terminal
awplus(config)# interface eth1
awplus(config-if)# encapsulation dot1q 1
```

To enable 802.1Q encapsulation on tunnel interface tunnel20, use the commands:

```
awplus# configure terminal
awplus(config)# interface tunnel20
awplus(config-if)# encapsulation dot1q 2
```

To enable multiple 802.1Q encapsulation on Ethernet interface eth1, use the commands:

```
awplus# configure terminal
awuplus(config)# interface eth1
awplus(config-if)# encapsulation dot1q 1
awplus(config-if)# encapsulation dot1q 2
awplus(config-if)# encapsulation dot1q 3
```

To disable 802.1Q encapsulation on eth1, use the commands:

```
awplus# configure terminal
awuplus(config)# interface eth1
awuplus(config-if)# no encapsulation dot1q 1
```

Related commands [interface \(to configure\)](#)
[show interface](#)

19

PPP Commands

Introduction

Overview This chapter provides an alphabetical reference of commands used to configure and validate the PPP (Point-To-Point) protocol. For more information about PPP, see the [Point-to-Point Protocol \(PPP\) Feature Overview and Configuration Guide](#).

- Command List**
- “[debug ppp](#)” on page 666
 - “[encapsulation ppp](#)” on page 669
 - “[interface \(PPP\)](#)” on page 671
 - “[ip address negotiated](#)” on page 672
 - “[ip tcp adjust-mss](#)” on page 674
 - “[ip unnumbered](#)” on page 676
 - “[ipv6 tcp adjust-mss](#)” on page 678
 - “[keepalive \(PPP\)](#)” on page 680
 - “[mtu \(PPP\)](#)” on page 682
 - “[peer default ip address](#)” on page 683
 - “[peer neighbor-route](#)” on page 685
 - “[ppp authentication](#)” on page 687
 - “[ppp authentication refuse](#)” on page 689
 - “[ppp hostname](#)” on page 691
 - “[ppp ipcp dns](#)” on page 693
 - “[ppp ipcp dns suffix-list](#)” on page 695
 - “[ppp ipcp ip-override](#)” on page 697
 - “[ppp password](#)” on page 698
 - “[ppp service-name \(PPPoE\)](#)” on page 699

- [“ppp timeout idle”](#) on page 700
- [“ppp username”](#) on page 701
- [“show debugging ppp”](#) on page 702
- [“show interface \(PPP\)”](#) on page 703
- [“undebug ppp”](#) on page 707

debug ppp

Overview Use this command to enable PPP protocol debugging on an optionally specified PPP interface or range of PPP interfaces to analyze PPP behavior when diagnosing PPP connectivity issues. If no interface is specified then debugging for all PPP interfaces is enabled.

Use the **no** variant of this command to disable PPP protocol debugging on the specified PPP interface. If no PPP interface is specified then PPP debugging for all PPP interfaces is disabled.

Syntax `debug ppp [interface <ppp-interface-list>]`
`no debug ppp [interface <ppp-interface-list>]`

Parameter	Description
<code><ppp-interface-list></code>	Specify a PPP interface or a range of PPP interfaces in the range <code>ppp<0-255></code> . Use a hyphen between PPP interfaces to include all PPP interfaces in a given range, or use commas between PPP interfaces to specify non-contiguous PPP interfaces.

Default No diagnostic messages are enabled for PPP debugging. PPP debugging is disabled by default.

Mode Global Configuration and Privileged Exec

Usage notes Debugging messages are sent to the logging system and can be viewed in log output, filtered in permanent or buffered logs, and viewed on the terminal using the [terminal monitor](#) command. See the status of PPP debugging with the [show debugging ppp](#) command.

Note that debugging output for PPP shows packet debugging and events debugging, see output below.

Note that disabling all debugging with the [no debug all](#) or the [undebug all](#) commands also disables PPP debugging configured with this command.

Note that the negated form of this command is an alias of the [undebug ppp](#) command.

Examples To enable PPP debugging on all PPP interfaces and send diagnostic messages to the system log, use the below command:

```
awplus# debug ppp
```

To enable PPP debugging on PPP interfaces `ppp0` through `ppp2` and display them on the console, use the below commands:

```
awplus# terminal monitor
```

```
awplus# debug ppp interface ppp0-ppp2
```

Output of packet debugging

Figure 19-1: Example output from the **debug ppp** command on the console

```
awplus#terminal monitor
awplus#debug ppp

05:35:46 awplus pppd[24767]: [ppp0] [05:35:46.901] sent [IPCP
ConfReq id=0x1 <addr
0.0.0.0> <ms-dns1 0.0.0.0> <ms-dns2 0.0.0.0>]
05:35:46 awplus pppd[24767]: [ppp0] [05:35:46.901] sent [IPV6CP
ConfReq id=0x1
<addr fe80::eecd:6dff:fe3a:0d23>]
05:35:46 awplus pppd[24767]: [ppp0] [05:35:46.901] rcvd [LCP
ConfAck id=0x1 <magic
0xd9153444>]
05:35:46 awplus pppd[24767]: [ppp0] [05:35:46.919] rcvd [IPCP
ConfReq id=0x1 <addr
192.168.1.1>]
05:35:46 awplus pppd[24767]: [ppp0] [05:35:46.919] sent [IPCP
ConfAck id=0x1 <addr
192.168.1.1>]
05:35:46 awplus pppd[24767]: [ppp0] [05:35:46.919] rcvd [IPCP
ConfNak id=0x1 <addr
192.168.1.2> <ms-dns1 1.1.1.1> <ms-dns2 2.2.2.2>]
05:35:46 awplus pppd[24767]: [ppp0] [05:35:46.920] sent [IPCP
ConfReq id=0x2 <addr
192.168.1.2> <ms-dns1 1.1.1.1> <ms-dns2 2.2.2.2>]
05:35:46 awplus pppd[24767]: [ppp0] [05:35:46.921] rcvd [LCP
ProtRej id=0x2 80 57
01 01 00 0e 01 0a ee cd 6d ff fe 3a 0d 23]
05:35:46 awplus pppd[24767]: [ppp0] [05:35:46.921] Protocol-Reject
for 'IPv6
Control Protocol' (0x8057) received
05:35:46 awplus pppd[24767]: [ppp0] [05:35:46.922] rcvd [IPCP
ConfAck id=0x2 <addr
192.168.1.2> <ms-dns1 1.1.1.1> <ms-dns2 2.2.2.2>]
02:25:35 awplus pppd[2388]: [ppp1] [02:25:35.990] sent [LCP
EchoReq id=0x3b
magic=0xe1e041db]
02:25:35 awplus pppd[2388]: [ppp1] [02:25:35.991] rcvd [LCP
EchoReq id=0x3b
magic=0xe3e331b1]
02:25:35 awplus pppd[2388]: [ppp1] [02:25:35.991] sent [LCP
EchoRep id=0x3b
magic=0xe1e041db]
02:25:35 awplus pppd[2388]: [ppp1] [02:25:35.992] rcvd [LCP
EchoRep id=0x3b
magic=0xe3e331b1]
```

Output of event debugging

Figure 19-2: Example output from the **debug ppp** command for a PPP interface

```
awplus#terminal monitor
awplus#debug ppp interface ppp0

05:35:43 awplus pppd[24767]: [ppp0] [05:35:43.710] using channel 1
05:35:43 awplus pppd[24767]: [ppp0] [05:35:43.712] Using interface
ppp0
05:35:43 awplus pppd[24767]: [ppp0] [05:35:43.712] Connect: ppp0
<--> hdlc0
05:35:46 awplus PPP: IP is up on interface ppp0 [local-IP:
192.168.1.2, remote-IP:
192.168.1.1]
05:35:46 awplus PPP: IPCP [ppp0]: add IP interface [IP-addr:
192.168.1.2, mask: ]
05:35:46 awplus PPP: IPCP [ppp0]: add host route [peer-IP:
192.168.1.1]
05:35:47 awplus PPP: IPCP [ppp0]: add domain name server [DNS:
1.1.1.1]
05:35:47 awplus PPP: IPCP [ppp0]: add domain name server [DNS:
2.2.2.2]
```

To record messages relating to PPP packets in the buffered log, first configure a buffered log filter to select the messages using the commands:

```
awplus# configure terminal
awplus(config)# log buffered level debug program pppd
awplus(config)# end
```

Then configure PPP debugging, using the below command:

```
awplus# debug ppp
```

To disable PPP debugging for all PPP interfaces, use the below command:

```
awplus# no debug ppp
```

Related commands

- [terminal monitor](#)
- [encapsulation ppp](#)
- [no debug all](#)
- [ppp authentication](#)
- [show debugging ppp](#)
- [show interface \(PPP\)](#)
- [undebug all](#)

encapsulation ppp

Overview Use this command to enable PPP encapsulation and create one or more PPP interfaces over Ethernet, a cellular interface, or an L2TPv2 managed VPN.

Use the **no** variant of this command to disable PPP encapsulation and remove the specified PPP interface.

Syntax encapsulation ppp <index>
no encapsulation ppp <index>

Parameter	Description
<index>	The PPP interface index number in the range from 0 to 255.

Default No PPP encapsulation or interfaces are configured by default.

Mode Interface Configuration mode for an Ethernet interface (e.g. **interface eth1**), or an Ethernet sub-interface (e.g. **interface eth1.1**), or a cellular interface (e.g. **interface cellular0**).

L2TP Tunnel Configuration mode for an L2TP tunnel (e.g. **l2tp tunnel tunnel0**).

Examples To configure a PPP interface with index 0 for Ethernet interface eth1, use the commands:

```
awplus# configure terminal
awplus(config)# interface eth1
awplus(config-if)# encapsulation ppp 0
```

To shut down the ppp0 interface and remove it from Ethernet interface eth1, use the commands:

```
awplus# configure terminal
awplus(config)# interface ppp0
awplus(config-if)# shutdown
awplus(config-if)# interface eth1
awplus(config-if)# no encapsulation ppp 0
```

To set the L2TP tunnel tunnel1 to encapsulate the PPP interface with index 1, use the commands:

```
awplus# configure terminal
awplus(config)# l2tp tunnel tunnel1
awplus(config-l2tp-tunnel)# encapsulation ppp 1
```

To remove the PPP interface with index 1 from L2TP tunnel tunnel1, use the commands:

```
awplus# configure terminal
awplus(config)# l2tp tunnel tunnel1
awplus(config-l2tp-tunnel)# no encapsulation ppp 1
```

**Related
commands**

[l2tp tunnel](#)
[ppp service-name \(PPPoE\)](#)
[show interface \(PPP\)](#)

interface (PPP)

Overview Use this command to select a PPP interface to configure.

You need to use the [encapsulation ppp](#) command to enable PPP encapsulation and create PPP interfaces first.

Syntax `interface <PPP-interface-list>`

Parameter	Description
<code><PPP-interface-list></code>	The PPP interfaces or ports to configure. An interface-list can be: <ul style="list-style-type: none">• a PPP interface (e.g. ppp0)• a continuous range of PPP interfaces, separated by a hyphen (e.g. ppp0-ppp2)• a comma-separated non-continuous list of PPP interfaces (e.g. ppp0, ppp2) The specified interfaces must exist.

Mode Global Configuration

Example The following example shows how to enter Interface mode to configure a PPP interface.

```
awplus# configure terminal
awplus(config)# interface ppp0
awplus(config-if)#
```

Related commands

- [ip address \(IP Addressing and Protocol\)](#)
- [show interface](#)
- [show interface brief](#)

ip address negotiated

Overview Use this command to obtain an IP address with the peer for a PPP interface via IPCP (Internet Protocol Control Protocol) address negotiation when configuring a PPP link for IP traffic.

Use the **no** variant of this command to remove IP address negotiation settings.

Syntax `ip address negotiated [<default-ip-address>]`
`no ip address negotiated`

Parameter	Description
<code><default-ip-addr></code>	Specify an optional default IP address for use instead of an IP address assigned from the peer that is otherwise configured for a PPP interface.

Default No IP address negotiation with the peer is configured by default.

Mode Interface Configuration for a PPP interface

Usage notes Use this command to enable the device to automatically negotiate an IP address for a PPP interface, and to enable all remote hosts to access the device using this IP address. When the peer does not send an IP address via IPCP negotiation, the specified default IP address will be used.

Examples To configure the PPP interface ppp0 to use IPCP to negotiate an IP address for itself, use the below commands:

```
awplus# configure terminal
awplus(config)# interface ppp0
awplus(config-if)# ip address negotiated
```

To configure the PPP interface ppp0 to a default IP address of 10.9.9.2, for use when the peer does not send an IP address via IPCP negotiation, use the below commands:

```
awplus# configure terminal
awplus(config)# interface ppp0
awplus(config-if)# ip address negotiated 10.9.9.2
```

To stop the PPP interface ppp0 from using IPCP to negotiate an IP address for itself, use the below commands:

```
awplus# configure terminal
awplus(config)# interface ppp0
awplus(config-if)# no ip address negotiated
```

Output To verify IPCP address negotiation is configured on PPP interface ppp0, use the following command:

```
awplus# show running-config interface ppp0
```

Figure 19-3: Example output from **show running-config interface ppp0** to verify IPCP configuration:

```
!  
interface ppp0  
 ip address negotiated  
!
```

Related commands

- [show ip interface](#)
- [encapsulation ppp](#)
- [peer default ip address](#)
- [show running-config interface](#)

ip tcp adjust-mss

Overview Use this command to set the Maximum Segment Size (MSS) size for an interface, where MSS is the maximum TCP data packet size that the interface can transmit before fragmentation.

Use the **no** variant of this command to remove a previously specified MSS size for a PPP interface, and restore the default MSS size.

Syntax `ip tcp adjust-mss {<mss-size>|pmtu}`
`no ip tcp adjust-mss`

Parameter	Description
<code><mss-size></code>	<code><64-1460></code> Specifies the MSS size in bytes.
<code>pmtu</code>	Adjust TCP MSS automatically with respect to the MTU on the interface.

Default The default setting allows a TCP server or a TCP client to set the MSS value for itself.

Mode Interface Configuration

Usage notes When a host initiates a TCP session with a server it negotiates the IP segment size by using the MSS option field in the TCP packet. The value of the MSS option field is determined by the Maximum Transmission Unit (MTU) configuration on the host.

You can set a feasible MSS value on the following interfaces:

- PPP
- Ethernet
- Tunnel
- VLAN

Examples To configure an MSS size of 1452 bytes on PPP interface ppp0, use the commands:

```
awplus# configure terminal
awplus(config)# interface ppp0
awplus(config-if)# ip tcp adjust-mss 1452
```

To configure an MSS size of 1452 bytes on Ethernet interface eth1, use the commands:

```
awplus# configure terminal
awplus(config)# interface eth1
awplus(config-if)# ip tcp adjust-mss 1452
```

To configure an MSS size of 1452 bytes on interface tunnel2, use the commands:

```
awplus# configure terminal
awplus(config)# interface tunnel2
awplus(config-if)# ip tcp adjust-mss 1452
```

To restore the MSS size to the default size on PPP interface ppp0, use the commands:

```
awplus# configure terminal
awplus(config)# interface ppp0
awplus(config-if)# no ip tcp adjust-mss
```

**Related
commands**

[mtu \(PPP\)](#)
[show interface](#)
[show interface \(PPP\)](#)
[show interface tunnel \(GRE\)](#)

**Command
changes**

Version 5.4.8-2.1: interface tunnel example added

ip unnumbered

Overview Use this command to borrow an IP address from the specified interface, on an unnumbered PPP interface.

Use the **no** variant of this command to remove the borrowed IP address.

Syntax `ip unnumbered <interface-name>`
`no ip unnumbered`

Parameter	Description
<code><interface-name></code>	Name of the interface from which the IP address is to be borrowed. Valid interface types from which the IP address can be borrowed are VLAN, Ethernet, loopback, and bridge.

Default IP unnumbered is disabled by default.

Mode Interface Configuration for a PPP interface

Usage notes An unnumbered PPP interface can process IP packets without explicitly assigning an IP address. This is achieved by borrowing the primary IP address from the specified VLAN, Ethernet, loopback, or bridge interface.

Examples To borrow an IP address on unnumbered PPP from vlan2, use the following commands:

```
awplus# configure terminal
awplus(config)# interface vlan2
awplus(config-if)# ip address 6.6.6.6/24
awplus(config-if)# exit
awplus(config)# interface ppp0
awplus(config-if)# ip unnumbered vlan2
```

To remove the borrowed IP address, use the following commands:

```
awplus# configure terminal
awplus(config)# interface ppp0
awplus(config-if)# no ip unnumbered
```

To verify borrowed address is configured on PPP interface ppp0, use the following command:

```
awplus# show interface ppp0
```

Figure 19-4: Example output from a **show interface** ppp0 to verify PPP IP borrowing configuration:

```
awplus#show interface ppp0
Interface ppp0
  Link is UP, administrative state is UP
  Hardware is PPP
  Interface is unnumbered. Using IPv4 address of vlan2 (2.2.2.2)
  index 16778240 metric 1 mtu 1492
  <UP,POINT-TO-POINT,RUNNING,NOARP,MULTICAST>
  PPP is running over interface eth1
  LCP Opened IPCP Opened
  MRU(bytes): Local config 1492, Local negotiated 1492, Peer
  negotiated 1492
  Magic number: Local config ON, Local negotiated ON, Peer
  negotiated ON
  Authentication: Local config None, Local neg None, Peer neg CHAP
  IPv4 addresses: Local config 0.0.0.0
                  Local neg 2.2.2.2, Peer neg 1.1.1.1
  IPv6 Id Local config: 0000:0000:0000:0000
  PPPoE is using the default service
  SNMP link-status traps: Disabled
    input packets 2, bytes 20, dropped 0, multicast packets 0
    output packets 2, bytes 20, multicast packets 0 broadcast
  packets 0
  Time since last state change: 0 days 00:00:13
```

Related commands

- [show ip interface](#)
- [show interface tunnel \(L2TPv3\)](#)
- [show running-config interface](#)

ipv6 tcp adjust-mss

Overview Use this command to set the IPv6 Maximum Segment Size (MSS) size for an interface, where MSS is the maximum TCP data packet size that the interface can transmit before fragmentation.

Use the **no** variant of this command to remove a previously specified MSS size for a PPP interface, and restore the default MSS size.

Syntax `ipv6 tcp adjust-mss {<mss-size>|pmtu}`
`no ipv6 tcp adjust-mss`

Parameter	Description
<code><mss-size></code>	<code><64-1460></code> Specifies the MSS size in bytes.
<code>pmtu</code>	Adjust TCP MSS automatically with respect to the MTU on the interface.

Default The default setting allows a TCP server or a TCP client to set the MSS value for itself.

Mode Interface Configuration

Usage notes When a host initiates a TCP session with a server it negotiates the IP segment size by using the MSS option field in the TCP packet. The value of the MSS option field is determined by the Maximum Transmission Unit (MTU) configuration on the host.

You can set a feasible MSS value on the following interfaces:

- PPP
- Ethernet
- Tunnel
- VLAN

Examples To configure an IPv6 MSS size of 1452 bytes on PPP interface ppp0, use the commands:

```
awplus# configure terminal
awplus(config)# interface ppp0
awplus(config-if)# ipv6 tcp adjust-mss 1452
```

To configure an IPv6 MSS size of 1452 bytes on Ethernet interface eth1, use the commands:

```
awplus# configure terminal
awplus(config)# interface eth1
awplus(config-if)# ipv6 tcp adjust-mss 1452
```

To adjust IPv6 TCP MSS automatically with respect to the MTU on interface tunnel2, use the commands:

```
awplus# configure terminal
awplus(config)# interface tunnel2
awplus(config-if)# ipv6 tcp adjust-mss pmtu
```

To restore the MSS size to the default size on PPP interface ppp0, use the commands:

```
awplus# configure terminal
awplus(config)# interface ppp0
awplus(config-if)# no ipv6 tcp adjust-mss
```

**Related
commands**

[mtu \(PPP\)](#)
[show interface](#)
[show interface \(PPP\)](#)
[show interface tunnel \(GRE\)](#)

**Command
changes**

Version 5.4.8-2.1: interface tunnel example added

keepalive (PPP)

Overview Use this command to enable LCP (Link Control Protocol) Echo keepalive request messages and change LCP echo parameters on a given PPP interface in Interface Configuration mode.

Use the **no** variant of this command to disable LCP Echo keepalive request messages on a given PPP interface in Interface Configuration mode. Note that disabling the sending of LCP Echo keepalive request messages does not stop a device responding to LCP Echo requests.

Syntax `keepalive [[interval <interval>] [attempts <attempt-limit>]]no keepalive`

Parameter	Description
<interval>	Specify the interval in seconds in the range <1-600> seconds between LCP Echo keepalive request messages, for a PPP interface. Default: 10
<attempt-limit>	Specify the number of missing LCP Echo keepalive response messages, in the range <1-10> for a PPP interface, before the link is considered as being link down and link renegotiation starts to reestablish the link. Default: 3

Default The sending of LCP Echo keepalive messages on a PPP interface is disabled by default. If no optional **interval** is specified then the default interval duration is configured to 10 seconds. If no optional **attempts** are specified then the default attempt limit is configured to 3 attempts.

Mode Interface Configuration for a PPP interface

Example To enable the device to send LCP Echo keepalive messages on the PPP interface `ppp0` with the default 10 second interval when no interval is specified and the default 3 attempts when no attempt is specified, enter the below commands:

```
awplus# configure terminal
awplus(config)# interface ppp0
awplus(config-if)# keepalive
```

To enable the device to send LCP Echo keepalive messages on the PPP interface `ppp0` with double the default values for a 20 second interval and 6 attempts, enter the below commands:

```
awplus# configure terminal
awplus(config)# interface ppp0
awplus(config-if)# keepalive interval 20 attempts 6
```

To disable the device from sending LCP Echo keepalive messages on the PPP interface ppp0, enter the below commands:

```
awplus# configure terminal
awplus(config)# interface ppp0
awplus(config-if)# no keepalive
```

Related commands [show running-config interface](#)

mtu (PPP)

Overview Use this command to set the Maximum Transmission Unit (MTU) size for a PPP interface, where MTU is the maximum packet size that PPP interfaces can transmit.

Use the **no** variant of this command to remove a previously specified MTU size for a PPP interface, and restore the default MTU size (1492 bytes) for PPP interfaces.

Syntax `mtu <mtu-size>`
`no mtu`

Parameter	Description
<code><mtu-size></code>	<code><68-1492></code> Specifies the Maximum Transmission Unit (MTU) size in bytes, where 1492 bytes is the default MTU size for a PPPoE interface and 1500 bytes for PPP via other lower layer interface types. This allows for the 8-byte PPPoE header that is added to make up the total of a 1582 byte packet that matches the default MTU size for the Ethernet link..

NOTE: For PPPoE the minimum MTU value is 128.

Default The default MTU size is 1492 bytes for PPPoE interfaces. The MTU should be greater than, or equal to, the MSS.

Mode Interface Configuration for PPP interfaces.

Usage notes If a router receives an IPv4 packet for another PPP interface with an MTU size smaller than the packet size, and if the packet has the '**don't fragment**' bit set, then the switch will send an ICMP '**destination unreachable**' (3) packet type and a '**fragmentation needed and DF set**' (4) code back to the source.

See the `ip tcp adjust-mss` command to set the Maximum Segment Size (MSS) after first setting the MTU size.

Examples To configure an MTU size of 1492 bytes on PPP interface ppp0, use the commands:

```
awplus# configure terminal
awplus(config)# interface ppp0
awplus(config-if)# mtu 1492
```

To restore the MTU size to the default MTU size of 1492 bytes on PPP interface ppp0, use the commands

```
awplus# configure terminal
awplus(config)# interface ppp0
awplus(config-if)# no mtu
```

Related commands `ip tcp adjust-mss`
`show interface (PPP)`

peer default ip address

Overview Use this command to set the default IP address assigned to the peer if required for a given PPP interface.

Use the optional **required** keyword with this command to specify that the peer must use this address for a given PPP interface, or drop the connection.

Use the **no** variant of this command to remove the previously specified peer default IP address for a given PPP interface.

Syntax peer default ip address <default-ip-address> [required]
no peer default ip address

Parameter	Description
<default-ip-address>	Specify the IPv4 address to be assigned to the peer upon request.
required	Optionally specify the peer to acknowledge the default IP address, which requires the peer to use the address or drop the connection.

Default No default IP address is configured to be assigned to the peer.

Mode Interface Configuration for a PPP interface

Examples To configure the PPP interface `ppp0` to assign the IP address of `192.168.0.1` to its peer upon request, use the below commands:

```
awplus# configure terminal
awplus(config)# interface ppp0
awplus(config-if)# peer default ip address 192.168.0.1
```

To configure the PPP interface `ppp0` to have the default peer IP address of `192.168.0.1`, and be required to use it or drop the connection, use the below commands:

```
awplus# configure terminal
awplus(config)# interface ppp0
awplus(config-if)# peer default ip address 192.168.0.1
required
```

To remove the default peer IP address of `192.168.0.1` from the PPP interface `ppp0`, enter the below commands:

```
awplus# configure terminal
awplus(config)# interface ppp0
awplus(config-if)# no peer default ip address
```

To verify the required peer default IP address 192.168.0.1 is configured on PPP interface ppp0, use the following command:

```
awplus# show running-config interface ppp0
```

Output

Table 1: Example output from the **show running-config interface ppp0** command

```
awplus# show running-config interface ppp0
!
interface ppp0
  peer default ip address 192.168.0.1 required
!
```

Related commands [ip address negotiated](#)
[show running-config interface](#)

peer neighbor-route

Overview Use this command in Interface Configuration mode for a PPP interface to re-enable the creation of peer neighbor routes after the default behavior has been disabled.

Use the **no** form of this command in Interface Configuration mode for a PPP interface to disable the default behavior of creating a neighbor route for the peer.

Syntax peer neighbor-route
no peer neighbor-route

Default A 32-bit host route (with a /32 mask) is created to the peer address on a PPP interface after PPP IPCP negotiation finishes.

Usage notes Use the **no** form of this command if the default behavior creates issues within your network. Use the [show ip route](#) command to validate the route behavior after issuing this command.

Mode Interface Configuration for a PPP interface

Examples To re-enable the default behavior for the PPP interface `ppp1`, where a 32-bit host route (with a /32 mask) is created to the peer address on a PPP interface after PPP IPCP negotiation finishes, enter the commands:

```
awplus# configure terminal
awplus(config)# interface ppp1
awplus(config-if)# peer neighbor-route
```

To disable the default behavior for the PPP interface `ppp0`, to prevent a 32-bit host route being added to the IP router table, enter the commands:

```
awplus# configure terminal
awplus(config)# interface ppp0
awplus(config-if)# no peer neighbor-route
```

Related commands [show interface \(PPP\)](#)
[show ip route](#)

Output Figure 19-5: Example validation output from the **show interface** and **show ip route** commands issued before and after the **no peer neighbor-route** command (see IPv4 address in **show interface** output and see connected routes **show ip route** output):

```
awplus#show interface pppl
Interface pppl
  Scope: both
  Link is UP, administrative state is UP
  Hardware is PPP
  IPv4 address 4.1.1.2/32 pointopoint 4.1.1.1
  index 16778241 metric 1 mtu 1460
  <UP,POINTOPOINT,RUNNING,NOARP,MULTICAST>
  VRF Binding: Not bound
  PPP is running over interface tunnell
  LCP Opened IPCP Opened
  L2TP session ID is 59451
  SNMP link-status traps: Disabled
    input packets 5, bytes 66, dropped 0, multicast packets 0
    output packets 4, bytes 46, multicast packets 0 broadcast packets 0
  Time since last state change: 0 days 00:02:24
awplus#show ip route
Codes: C - connected, S - static, R - RIP, B - BGP
       O - OSPF, IA - OSPF inter area
       N1 - OSPF NSSA external type 1, N2 - OSPF NSSA external type 2
       E1 - OSPF external type 1, E2 - OSPF external type 2
       * - candidate default

C       4.1.1.1/32 is directly connected, pppl
C       4.1.1.2/32 is directly connected, pppl
C       192.168.10.0/24 is directly connected, vlan1
awplus#configure terminal
Enter configuration commands, one per line.  End with CNTL/Z.
awplus(config)#interface pppl
awplus(config-if)#no peer neighbor-route
awplus(config-if)#exit
awplus(config)#exit
awplus#show interface pppl
Interface pppl
  Scope: both
  Link is UP, administrative state is UP
  Hardware is PPP
  IPv4 address 4.1.1.2/32
  index 16778241 metric 1 mtu 1460
  <UP,POINTOPOINT,RUNNING,NOARP,MULTICAST>
  VRF Binding: Not bound
  PPP is running over interface tunnell
  LCP Opened IPCP Opened
  L2TP session ID is 6262
  SNMP link-status traps: Disabled
    input packets 5, bytes 66, dropped 0, multicast packets 0
    output packets 4, bytes 46, multicast packets 0 broadcast packets 0
  Time since last state change: 0 days 00:00:09
awplus#show ip route
Codes: C - connected, S - static, R - RIP, B - BGP
       O - OSPF, IA - OSPF inter area
       N1 - OSPF NSSA external type 1, N2 - OSPF NSSA external type 2
       E1 - OSPF external type 1, E2 - OSPF external type 2
       * - candidate default

C       4.1.1.2/32 is directly connected, pppl
C       192.168.10.0/24 is directly connected, vlan1
```

ppp authentication

Overview Use this command in Interface Configuration mode for a PPP interface to configure PAP (Password Authentication Protocol), CHAP (Challenge Authentication Protocol), or EAP (Extensible Authentication Protocol).

Use the **no** form of this command in Interface Configuration mode for a PPP interface to disable all PAP, CHAP, and EAP authentication for a specified PPP interface.

Syntax `ppp authentication {eap|chap|pap}`
`no ppp authentication`

Parameter	Description
eap	Specify this parameter to enable EAP on a PPP interface
chap	Specify this parameter to enable CHAP on a PPP interface.
pap	Specify this parameter to enable PAP on a PPP interface.

Default There is no PPP authentication protocol defined or configured to a PPP interface by default.

Mode Interface Configuration for a PPP interface

Examples To enable PPP PAP authentication on the PPP interface `ppp0`, enter the commands:

```
awplus# configure terminal
awplus(config)# interface ppp0
awplus(config-if)# ppp authentication pap
```

To enable PPP CHAP authentication on the PPP interface `ppp0`, enter the commands:

```
awplus# configure terminal
awplus(config)# interface ppp0
awplus(config-if)# ppp authentication chap
```

To enable PPP EAP authentication on the PPP interface `ppp0`, enter the commands:

```
awplus# configure terminal
awplus(config)# interface ppp0
awplus(config-if)# ppp authentication eap
```

To attempt PPP EAP authentication, then fall back to PPP CHAP authentication if the attempt to enable PPP EAP authentication fails on the PPP interface `ppp0`, enter the commands:

```
awplus# configure terminal
awplus(config)# interface ppp0
awplus(config-if)# ppp authentication eap chap
```

To attempt PPP CHAP authentication, then fall back to PPP PAP authentication if the attempt to enable PPP CHAP authentication fails on the PPP interface `ppp0`, enter the commands:

```
awplus# configure terminal
awplus(config)# interface ppp0
awplus(config-if)# ppp authentication chap pap
```

To disable all PPP authentication on the PPP interface `ppp0`, enter the commands:

```
awplus# configure terminal
awplus(config)# interface ppp0
awplus(config-if)# no ppp authentication
```

Related commands

- [ppp authentication refuse](#)
- [ppp hostname](#)
- [ppp password](#)
- [ppp username](#)

ppp authentication refuse

Overview Use this command in Interface Configuration mode for a PPP interface to refuse EAP, CHAP (Challenge Handshake Authentication Protocol) or PAP (Password Authentication Protocol) authentication from peers requesting it.

Use the **no** form of this command in Interface Configuration mode for a PPP interface to allow authentication from peers requesting it.

Syntax `ppp authentication refuse {eap|chap|pap}`
`no ppp authentication refuse`

Parameter	Description
eap	Use this parameter to specify the router will refuse LCP configuration requests containing the authentication protocol option with EAP received on this PPP interface.
chap	Use this parameter to specify the router will refuse LCP configuration requests containing the authentication protocol option with CHAP received on this PPP interface.
pap	Use this parameter to specify the router will refuse LCP configuration requests containing the authentication protocol option with PAP on this PPP interface.

Mode Interface Configuration for a PPP interface

Usage notes This command specifies that EAP, CHAP or PAP authentication is disabled, so all requests by the peer for the user to authenticate using EAP, CHAP or PAP are refused.

Examples To refuse the use of PAP authentication if a peer requests PAP authentication, enter the commands:

```
awplus# configure terminal
awplus(config)# interface ppp0
awplus(config-if)# ppp authentication refuse pap
```

To refuse the use of CHAP authentication if a peer requests CHAP authentication, enter the commands:

```
awplus# configure terminal
awplus(config)# interface ppp0
awplus(config-if)# ppp authentication refuse chap
```

To refuse the use of EAP authentication if a peer requests EAP authentication, enter the commands:

```
awplus# configure terminal
awplus(config)# interface ppp0
awplus(config-if)# ppp authentication refuse eap
```

To allow the use of EAP, CHAP or PAP authentication if a peer requests EAP, CHAP or PAP authentication, enter the commands:

```
awplus# configure terminal
awplus(config)# interface ppp0
awplus(config-if)# no ppp authentication refuse
```

Related commands [ppp authentication](#)

ppp hostname

Overview Use this command in Interface Configuration mode for a PPP interface to configure a unique identifier for that PPP authenticator. This is used by the authenticator to fill the Name field in a CHAP challenge packet, or is used to fill the Server Name field in an EAP SRP-SHA1 (Subtype 1 Request) packet. The hostname sent with PPP packet exchanges is normally the hostname of the router, as configured with the [hostname](#) command.

Use the **no** form of this command in Interface Configuration mode for a PPP interface to disable a configured alternate hostname and revert to using the hostname, as configured with the [hostname](#) command.

See the Usage section below for information about when you may want to specify another hostname, instead of the system hostname configured from the [hostname](#) command, using this command.

Syntax `ppp hostname <hostname>`
`no ppp hostname <hostname>`

Parameter	Description
<code><hostname></code>	Specify this parameter to use an alternate hostname for PPP EAP and CHAP authentication instead of the hostname specified by the hostname command. The name can contain up to 255 characters. The name can contain any printable ASCII characters (ASCII 32-126). If the name contains the special characters backslash, double-quote or space, those characters should be escaped with a backslash.

Default The default PPP hostname is the system hostname as specified with the [hostname](#) command.

Mode Interface Configuration for a PPP interface

Usage notes This command allows the PPP username that is sent to be independent of the router hostname for a specific PPP interface.

Examples To enable the use of the alternate hostname `remote_router` for PPP authentication, enter the commands:

```
awplus# configure terminal
awplus(config)# interface ppp0
awplus(config-if)# ppp hostname remote_router
```

To disable the use of the alternate hostname `remote_router` for PPP authentication, enter the commands:

```
awplus# configure terminal
awplus(config)# interface ppp0
awplus(config-if)# no ppp hostname remote_router
```

Related commands [hostname](#)
[ppp authentication](#)

ppp ipcp dns

Overview Use this command to configure the primary and secondary DNS (Domain Name System) IP addresses for IPCP (Internet Protocol Control Protocol) on a given PPP interface.

Use the **no** variant of this command to remove the primary and secondary DNS IP addresses for IPCP on a given PPP interface, and remove any optional parameters configured for DNS.

Syntax `ppp ipcp dns [<primary> [<secondary>]] [required|reject|request]`
`no ppp ipcp dns`

Parameter	Description
<code><primary></code>	Specify the primary DNS address for a given PPP interface to the peer.
<code><secondary></code>	Specify the secondary DNS address for a given PPP interface to the peer.
<code>required</code>	Request DNS addresses from the peer, and close the link if none is given.
<code>reject</code>	Reject negotiations with the peer (default).
<code>request</code>	Request DNS addresses from the peer.

Default By default no IPCP DNS server request is sent to the peer.

Mode Interface Configuration

Usage notes Use the optional parameters to configure PPP IPCP DNS options for accepting, rejecting or requesting DNS addresses from the peer. Use the optional primary and secondary or primary only DNS server address placeholders to specify DNS server addresses to the peer.

The no variant of this command also stops IPCP DNS request messages being sent to the peer.

Examples To configure the PPP interface `ppp0` to require a DNS IP address from the peer, and close the link if a DNS IP address is not given, enter the below commands:

```
awplus# configure terminal
awplus(config)# interface ppp0
awplus(config-if)# ppp ipcp dns required
```

To configure the PPP interface `ppp0` to require a DNS IP address from the peer, enter the below commands:

```
awplus# configure terminal
awplus(config)# interface ppp0
awplus(config-if)# ppp ipcp dns request
```

To configure the PPP interface `ppp0` to reject a DNS IP address from the peer, enter the below commands:

```
awplus# configure terminal
awplus(config)# interface ppp0
awplus(config-if)# ppp ipcp dns reject
```

To configure the PPP interface `ppp0` to supply primary and secondary DNS server addresses to the peer, enter the below commands:

```
awplus# configure terminal
awplus(config)# interface ppp0
awplus(config-if)# ppp ipcp dns 10.1.1.2 10.1.1.3
```

To configure the PPP interface `ppp0` to supply a primary but not a secondary DNS server address to the peer, enter the below commands:

```
awplus# configure terminal
awplus(config)# interface ppp0
awplus(config-if)# ppp ipcp dns 10.1.1.2
```

**Related
commands**

[ip address negotiated](#)
[peer default ip address](#)
[peer neighbor-route](#)
[show running-config interface](#)

ppp ipcp dns suffix-list

Overview Use this command to configure a suffix-list to be associated with DNS name-servers learned over the PPP connection.

Use the **no** variant of this command to remove the suffix-list.

Syntax `ppp ipcp dns suffix-list <domain-list-name>`
`no ppp ipcp dns suffix-list`

Parameter	Description
<code><domain-list-name></code>	The name of the DNS domain-list

Mode Interface Configuration

Usage notes A PPP connection can be configured to learn DNS servers from the remote peer by using the command `ppp ipcp dns` command.

This command allows a user to associate a domain-list to be used to match against the suffixes of incoming DNS requests. For example, a customer branch office may have a router that is used to give remote-access to their head office, over which they learn the IP address of the head office's DNS server. A domain list can be created that contains a suffix used for services internal to that company, for example, "example.lc". This domain-list is associated as a suffix-list to the PPP connection. So when the PPP connection is completed with the head office, users at the branch office that browse to "intranet.example.lc" will have the DNS request forwarded to the DNS server learned over the PPP connection. Without having the suffix-list configured, the DNS request for "intranet.example.lc" would instead be sent to the primary DNS server, which is likely to be the branch office's ISP, and they will simply respond with a negative reply, because .example.lc is not a globally routable domain.

Examples At a branch office, to direct DNS lookups for domains with suffixes of "engineering.acme" or "intranet.acme" to an internal corporate name-server run at head-office that was learned over a PPP connection, use the commands:

```
awplus# configure terminal
awplus(config)# ip dns forwarding domain-list corporatedomains
host(config-domain-list)# description Our internal network
domains; do not send DNS requests to internet
host(config-domain-list)# domain engineering.acme
host(config-domain-list)# domain intranet.acme
awplus(config)# interface ppp0
awplus(config-if)# ppp ipcp dns required
awplus(config-if)# ppp ipcp dns suffix-list corporatedomains
```

**Related
commands** [ip dns forwarding domain-list](#)
[ppp ipcp dns](#)

ppp ipcp ip-override

Overview Use this command to override the IP address negotiated via IPCP with peer and use the statically configured address on a given PPP interface.

Use the **no** variant of this command to use any address negotiated with the peer via IPCP on a given PPP interface.

Syntax `ppp ipcp ip-override`
`no ppp ipcp ip-override`

Default By default the address is negotiated with the peer via IPCP.

Mode Interface Configuration

Examples To override the IP address negotiated with the peer via IPCP and use statically configured address on interface ppp0, use the commands below:

```
awplus# configure terminal
awplus(config)# interface ppp0
awplus(config-if)# ip address 192.168.1.100/24
awplus(config-if)# ppp ipcp ip-override
```

Related commands [show running-config interface](#)

ppp password

Overview Use this command in Interface Configuration mode for a PPP interface to configure a PPP secret password to be used in response to a challenge from an unknown remote peer.

Use the **no** form of this command in Interface Configuration mode for a PPP interface to disable a configured PPP secret password.

Syntax `ppp password <password>`
`no ppp password`

Parameter	Description
<code><password></code>	Specify this parameter to configure a PPP secret password to be used in response to an unknown remote peer. You can use any printable characters, including spaces. A password can contain up to 255 printable characters.

Default There is no PPP password defined or configured to a PPP interface by default.

Mode Interface Configuration for a PPP interface

Examples To enable the use of the PPP secret password `bobs_secret` for PPP authentication, enter the commands:

```
awplus# configure terminal
awplus(config)# interface ppp0
awplus(config-if)# ppp password bobs_secret
```

To disable the use of the PPP secret password `bobs_secret` for PPP authentication, enter the commands:

```
awplus# configure terminal
awplus(config)# interface ppp0
awplus(config-if)# no ppp password
```

Related commands [ppp authentication](#)
[ppp username](#)

ppp service-name (PPPoE)

Overview This command configures the PPPoE service name used to select a service from an access concentrator. This can only be applied when the PPP interface has been configured over an underlying eth interface.

Use the **no** variant of this command to set the service name for the connection back to the default (unset).

Syntax `ppp service-name <service-name>`
`no ppp service-name`

Parameter	Description
<code><service-name></code>	Specifies the PPPoE service name to select from an access concentrator. The service-name is 1 to 18 characters long, is case-sensitive, and for a PPPoE client is usually supplied by the ISP. The name can contain any printable ASCII characters (ASCII 32-126). If the name contains the special characters backslash, double-quote or space, those characters should be escaped with a backslash. The default is no service name.

Default The default option is not to specify a service name. This results in a connection to the default service specified by the access concentrator.

Mode Interface Configuration for a PPP interface

Usage notes You can only apply a single service name to each PPPoE interface.

Examples To connect to a service called "Internet", use the command:

```
awplus(config)# interface ppp0  
awplus(config-if)# ppp service-name Internet
```

Related commands [encapsulation ppp](#)
[show interface \(PPP\)](#)

ppp timeout idle

Overview Use this command to specify an idle time when a PPP connection is disconnected. Use the **no** variant of this command to reset the idle time to the default of 60 seconds.

Syntax `ppp timeout idle <0-99999>`
`no ppp timeout idle`

Parameter	Description
<code><0-99999></code>	The time in seconds before the idle timeout disconnects. If this is not specified the default value of 60 seconds is used.

Default PPP timeout idle is not set and the PPP Dial on Demand feature is disabled. If no idle time is set, the default value of 60 seconds is used.

Mode Interface Configuration

Usage notes This command allows an idle timer to disconnect a PPP connection after a specified time. The timer is reset upon either ingress or regress user traffic. Non-user traffic such as Link Control Protocol (LCP) keepalives and Network Control Protocol (NCP) negotiation packets do not reset the idle timer.

Examples To set the idle time to 30 seconds, enter the below commands:

```
awplus# configure terminal
awplus(config)# interface ppp0
awplus(config-if)# ppp timeout idle
30
```

To disable the use of the timer and disable the PPP Dial on Demand feature, enter the below commands:

```
awplus# configure terminal
awplus(config)# interface ppp0
awplus(config-if)# no ppp timeout
idle 30
```

Validation Commands `show running-config interface`

ppp username

Overview This command creates or modifies a username for a PPP user on a configured PPP interface.

Syntax `ppp username <username>`
`no ppp username`

Parameter	Description
<code><username></code>	Specify a login name for the user. The name can contain up to 255 characters. The name can contain any printable ASCII characters (ASCII 32-126). If the name contains the special characters backslash, double-quote or space, those characters should be escaped with a backslash.

Default There is no default PPP username defined or configured to a PPP interface.

Mode Interface Configuration for a PPP interface.

Examples To create the PPP username `bob`, for the PPP interface `ppp0`, use the commands:

```
awplus# configure terminal
awplus(config)# interface ppp0
awplus(config-if)# ppp username bob
```

To remove the PPP username `bob`, for the PPP interface `ppp0`, use the commands:

```
awplus# configure terminal
awplus(config)# interface ppp0
awplus(config-if)# no ppp username
```

Related commands [ppp authentication](#)
[ppp password](#)

show debugging ppp

Overview Use this command to display PPP debug settings for optionally specified PPP interfaces. If no PPP interfaces are specified then PPP debug settings are shown for all available PPP interfaces.

Syntax `show debugging ppp [interface <0-255>]`

Parameter	Description
<0-255>	Specify a PPP interface or a range of PPP interfaces in the range ppp<0-255>. Use a hyphen between PPP interfaces to include all PPP interfaces in a given range, or use commas between PPP interfaces to specify non-contiguous PPP interfaces.

Mode Privileged Exec

Examples The following example shows how to display PPP debug information for PPP interface ppp0:

```
awplus# show debugging ppp interface ppp0
```

The following example shows how to display PPP debug information for PPP interface ppp0 through ppp2:

```
awplus# show debugging ppp interface ppp0-ppp2
```

The following example shows how to display PPP debug information for PPP interface ppp0 and ppp2:

```
awplus# show debugging ppp interface ppp0,ppp2
```

The following example shows how to display PPP debug information for all available PPP interfaces:

```
awplus# show debugging ppp
```

Figure 19-6: Example output from the **show debugging ppp** command

```
awplus# show debugging ppp
PPP debugging status:
  PPP debug on interface ppp0: enabled
  PPP debug on interface ppp1: disabled
```

Related commands

- [debug ppp](#)
- [no debug all](#)
- [undebug all](#)
- [show interface \(PPP\)](#)

show interface (PPP)

Overview Use this command to display configuration and status information for a configured PPP (Point-to-Point) interface.

Syntax `show interface ppp<ppp_index>`

Parameter	Description
<code><ppp_index></code>	Display configuration and status information for the specified and configured PPP interface (0 to 255).

Mode User Exec and Privileged Exec

Usage notes See the [show interface brief](#) command for brief interface, configuration and status information.

Note the negotiated options, including those for DNS addresses, are shown in console output:

- Local DNS addresses as displayed in console output are provided from the peer.
- Peer DNS addresses as displayed in console output are provided to the peer.
- Only Peer DNS addresses or Local DNS addresses are shown, but not both.
- Echo Request Timer value as displayed in console output is the local setting.

Example The following example shows how to display the configuration and status information for a configured PPP interface named `ppp0`.

```
awplus# show interface ppp0
```

Figure 19-7: Example output from the **show interface** command for a PPPoE interface

```
awplus#show interface ppp0

Interface ppp0
  Scope: both
  Link is UP, administrative state is UP
  Hardware is PPP
  IPv4 address 10.1.0.2/32
  IPv6 address fe80::200:cdff:fe28:8a1/10
  index 16778440 metric 1
  <UP, POINTOPOINT, RUNNING, NOARP, MULTICAST>
  VRF Binding: Not bound
  PPP is running over interface eth0
  PPPoE is using the default service
  SNMP link-status traps: Disabled
    input packets 12, bytes 458, dropped 0, multicast packets 0
    output packets 6, bytes 122, multicast packets 0 broadcast
  packets 0
  Time since last state change: 0 days 00:01:57
```

Figure 19-8: Example output from the **show interface ppp1** command showing negotiated DNS addresses, where the peer provided the DNS information (see the **Local DNS addresses** field output below):

```
awplus#sh interface ppp1
Interface ppp1
  Scope: both
  Link is UP, administrative state is UP
  Hardware is PPP
  IPv4 address 192.168.1.1/30 pointopoint 192.168.1.2
  IPv6 address fe80::200:cdff:fe28:89f/10
  index 16778241 metric 1 mtu 1460
  <UP, POINTOPOINT, RUNNING, NOARP, MULTICAST>
  VRF Binding: Not bound
  PPP is running over interface tunnel1
  LCP Opened IPCP Opened IPV6CP Opened
  MRU(bytes): Local config 1460, Local negotiated 1460, Peer
  negotiated 1460
  Magic number: Local config ON, Local negotiated ON, Peer
  negotiated ON
  Authentication: Local config None, Local neg None, Peer neg None
  Echo Request Timer (seconds): 10
  IPv4 addresses: Local config 192.168.1.1, Peer neg 192.168.1.2
  IPv6 interface ID: Local eecd:6dff:fe3a:0d18, Peer neg
  eecd:6dff:fe3a:0d18
  Local DNS addresses: 192.168.60.1, 192.168.60.2
  L2TP session ID is 15288
  SNMP link-status traps: Disabled
    input packets 5, bytes 96, dropped 0, multicast packets 0
    output packets 5, bytes 96, multicast packets 0 broadcast
  packets 0
  Time since last state change: 0 days 00:06:29
awplus#
```

Figure 19-9: Example output from the **show interface ppp1** command showing negotiated DNS addresses, where the peer was provided with DNS information (see the **Peer DNS addresses** field output below):

```
awplus#sh interface ppp1
Interface ppp1
  Scope: both
  Link is UP, administrative state is UP
  Hardware is PPP
  IPv4 address 192.168.1.1/30 pointopoint 192.168.1.2
  IPv6 address fe80::200:cdff:fe28:89f/10
  index 16778241 metric 1 mtu 1460
  <UP, POINTOPOINT, RUNNING, NOARP, MULTICAST>
  VRF Binding: Not bound
  PPP is running over interface tunnell1
  LCP Opened IPCP Opened IPV6CP Opened
  MRU(bytes): Local config 1460, Local negotiated 1460, Peer
  negotiated 1460
  Magic number: Local config ON, Local negotiated ON, Peer
  negotiated ON
  Authentication: Local config None, Local neg None, Peer neg None
  Echo Request Timer (seconds): 10
  IPv4 addresses: Local config 192.168.1.1, Peer neg 192.168.1.2
  IPv6 interface ID: Local eecd:6dff:fe3a:0d18, Peer neg
  eecd:6dff:fe3a:0d18
  Peer DNS addresses: 1.1.1.1, 2.2.2.2
  L2TP session ID is 15288
  SNMP link-status traps: Disabled
    input packets 5, bytes 96, dropped 0, multicast packets 0
    output packets 5, bytes 96, multicast packets 0 broadcast
  packets 0
  Time since last state change: 0 days 00:06:29
awplus#
```

- Related commands**
- [encapsulation ppp](#)
 - [ppp service-name \(PPPoE\)](#)
 - [show interface](#)
 - [show interface brief](#)

undebbug ppp

Overview Use this command to disable PPP protocol debugging on the specified PPP interface or interfaces. If no PPP interface is specified then PPP debugging for all PPP interfaces is disabled.

This command has the same functionality as the **no** variant of the [debug ppp](#) command.

Syntax `undebbug ppp [interface <ppp-interface-list>]`

Parameter	Description
<code><ppp-interface-list></code>	Specify a PPP interface or a range of PPP interfaces in the range <code>ppp<0-255></code> . Use a hyphen between PPP interfaces to include all PPP interfaces in a given range, or use commas between PPP interfaces to specify non-contiguous PPP interfaces.

Default No diagnostic messages are enabled for PPP debugging. PPP debugging is disabled by default.

Mode Privileged Exec

Usage notes Note that this command is an alias of the negated form of the [debug ppp](#) command.

Examples To disable PPP debugging for all PPP interfaces, enter the below command:

```
awplus# undebbug ppp
```

To disable PPP debugging for PPP interfaces `ppp0`, enter the below command:

```
awplus# undebbug ppp interface ppp0
```

To disable PPP debugging for PPP interfaces `ppp0` through `ppp2`, enter the below command:

```
awplus# undebbug ppp interface ppp0-ppp2
```

To disable PPP debugging for PPP interfaces `ppp0` and `ppp2`, enter the below command:

```
awplus# undebbug ppp interface ppp0,ppp2
```

Related commands

- [debug ppp](#)
- [no debug all](#)
- [show debugging ppp](#)
- [undebbug all](#)

20

PPP over Ethernet (PPPoE) Commands

Introduction

Overview This chapter provides an alphabetical reference of commands used to configure Point to Point Protocol over Ethernet (PPPoE) related features. This includes PPPoE Client, PPPoE Access Concentrator, and PPPoE Relay.

For more information, see the [PPP Feature Overview and Configuration Guide](#) and the [L2TPv2 Tunneling of PPP Feature Overview and Configuration Guide](#).

- Command List**
- [“clear pppoe-ac statistics”](#) on page 710
 - [“client \(pppoe-relay\)”](#) on page 711
 - [“debug pppoe-ac”](#) on page 712
 - [“destination l2tp”](#) on page 713
 - [“l2tp peer-address dns-lookup”](#) on page 714
 - [“l2tp peer-address radius-lookup group”](#) on page 716
 - [“l2tp peer-address static”](#) on page 717
 - [“l2tp profile”](#) on page 719
 - [“max-sessions”](#) on page 721
 - [“ppp-auth-protocol”](#) on page 722
 - [“pppoe-ac”](#) on page 723
 - [“pppoe-ac-service”](#) on page 724
 - [“pppoe-relay”](#) on page 725
 - [“proxy-auth”](#) on page 726
 - [“server \(pppoe-relay\)”](#) on page 727
 - [“service-name”](#) on page 728
 - [“show debugging pppoe ac”](#) on page 730
 - [“show pppoe-ac config-check”](#) on page 731

- [“show pppoe-ac connections”](#) on page 733
- [“show pppoe-ac statistics”](#) on page 735
- [“show running-config pppoe-ac”](#) on page 738
- [“show running-config pppoe-relay”](#) on page 739
- [“timeout \(pppoe-relay\)”](#) on page 740

clear pppoe-ac statistics

Overview Use this command to zero all the PPPoE Access Concentrator statistics counters, and restart the counters incrementing from zero.

To see the affected counter values, use the command [show pppoe-ac statistics](#).

Syntax `clear pppoe-ac statistics`

Default n/a

Mode Privileged Exec

Example To set all the PPPoE Access Concentrator statistics counters to zero, use the command:

```
awplus# clear pppoe-ac statistics
```

Related commands [show pppoe-ac statistics](#)

client (pppoe-relay)

Overview Use this command to configure a PPPoE relay client interface.
Use the **no** variant of this command to remove a PPPoE relay client interface.

Syntax `client <client-interface>`
`no client <client-interface>`

Parameter	Description
<code><client-interface></code>	The PPPoE relay client interface. The valid interface types are: eth and vlan.

Default None.

Mode PPPoE Relay Configuration

Example To configure eth1 as the client interface on PPPoE relay instance 'Telco1', use the commands:

```
awplus# pppoe-relay Telco1  
awplus(config-pppoe-relay)# client eth1
```

To remove the eth1 client interface configured on PPPoE relay instance 'Telco1', use the commands:

```
awplus# pppoe-relay Telco1  
awplus(config-pppoe-relay)# no client eth1
```

Related commands [server \(pppoe-relay\)](#)
[timeout \(pppoe-relay\)](#)
[max-sessions](#)
[pppoe-relay](#)
[show running-config pppoe-relay](#)

Command changes Version 5.5.0-1.3: command added

debug pppoe-ac

Overview Use this command to enable debugging of the PPPoE Access Concentrator. Use the **no** variant of this command to disable debugging of the PPPoE Access Concentrator.

Syntax debug pppoe-ac
no debug pppoe-ac

Parameter	Description
<varname>	Description of varname

Default PPPoE Access Concentrator debugging is disabled by default.

Mode Privileged Exec

Example To enable PPPoE AC debugging, use the commands:

```
awplus# debug pppoe-ac  
awplus# terminal monitor  
% Warning: Console logging enabled
```

Related commands debug l2tp
show debugging pppoe ac

destination l2tp

Overview Use this command to set the destination to forward all PPPoE packets to the peer over L2TP.

Use the **no** variant of this command to unset the destination for PPPoE packets.

Syntax `destination l2tp`
`no destination`

Default This command is not configured by default.

Mode PPPoE Access Concentrator Configuration

Example To sets the destination to forward all PPPoE packets for the service 'ISP-service' to the peer over L2TP, use the commands:

```
awplus# configure terminal
awplus(config)# pppoe-ac ISP-service
awplus(config-pppoe-ac)# destination l2tp
```

To unset the destination for PPPoE packets for the service 'ISP-service', use the commands:

```
awplus# configure terminal
awplus(config)# pppoe-ac ISP-service
awplus(config-pppoe-ac)# no destination
```

Related commands

- [l2tp peer-address dns-lookup](#)
- [l2tp peer-address radius-lookup group](#)
- [l2tp peer-address static](#)
- [l2tp profile](#)
- [pppoe-ac](#)
- [ppp-auth-protocol](#)
- [service-name](#)
- [show running-config pppoe-ac](#)

l2tp peer-address dns-lookup

Overview Use this command to set the LNS address to use via a DNS lookup from the username email domain for this PPPoE Access Concentrator service.

Use the **no** variant of this command to remove the DNS lookup setting for this PPPoE AC service.

Syntax `l2tp peer-address dns-lookup [prefix <prefix>|]`
`no l2tp peer-address`

Parameter	Description
<prefix>	A string to prepend to the domain name portion of the username.

Default This command is not set by default.

Mode PPPoE Access Concentrator Configuration

Example To set the LNS address to use via a DNS lookup for the PPPoE AC service 'ISP-service', use the commands:

```
awplus# configure terminal
awplus(config)# pppoe-ac ISP-service
awplus(config-pppoe-ac)# l2tp peer-address dns-lookup
```

To set the LNS address to use via a DNS lookup and prepend "lns" to the domain name portion of the username, use the commands:

```
awplus# configure terminal
awplus(config)# pppoe-ac ISP-service
awplus(config-pppoe-ac)# l2tp peer-address dns-lookup prefix
lns
```

To remove the DNS lookup setting for the PPPoE AC service 'ISP-service', use the commands:

```
awplus# configure terminal
awplus(config)# pppoe-ac ISP-service
awplus(config-pppoe-ac)# no l2tp peer-address
```

Related commands

- [destination l2tp](#)
- [l2tp peer-address radius-lookup group](#)
- [l2tp peer-address static](#)
- [l2tp profile](#)
- [pppoe-ac](#)
- [ppp-auth-protocol](#)

service-name

show running-config pppoe-ac

l2tp peer-address radius-lookup group

Overview Use this command to set this PPPoE Access Concentrator (AC) service to get the LNS address by a RADIUS lookup.

Use the **no** variant of this command to remove the L2TP peer address setting.

Syntax `l2tp peer-address radius-lookup group <radius-group-name>`
`no l2tp peer-address`

Parameter	Description
<code><radius-group-name></code>	The name of the RADIUS group to lookup.

Default No L2TP peer address is set by default.

Mode PPPoE Access Concentrator Configuration

Example To find peer address via RADIUS lookup from Radius server group called "GROUP1", use the commands:

```
awplus# configure terminal
awplus(config)# pppoe-ac ISP-service
awplus(config-pppoe-ac)# l2tp peer-address radius-lookup group
GROUP1
```

To remove the RADIUS lookup setting for the PPPoE AC service 'ISP-service', use the commands:

```
awplus# configure terminal
awplus(config)# pppoe-ac ISP-service
awplus(config-pppoe-ac)# no l2tp peer-address
```

Related commands

- [aaa group server](#)
- [destination l2tp](#)
- [l2tp peer-address dns-lookup](#)
- [l2tp peer-address static](#)
- [l2tp profile](#)
- [pppoe-ac](#)
- [ppp-auth-protocol](#)
- [service-name](#)
- [show running-config pppoe-ac](#)

l2tp peer-address static

Overview Use this command to set the IP address or fully qualified domain name of the L2TP peer (LNS) to which the L2TP tunnel should be established for this PPPoE Access Concentrator route.

Use the **no** variant of this command to remove the configured L2TP peer (LNS) address.

Syntax `l2tp peer-address static`
`{<l2tp-peer-ip-address>|<l2tp-peer-domain-name>}`
`no l2tp peer-address`

Parameter	Description
<code><l2tp-peer-ip-address></code>	The IPv4 address of the L2TP peer (LNS) for this PPPoE AC route, in dotted-decimal format.
<code><l2tp-peer-domain-name></code>	The fully-qualified domain name of the L2TP peer (LNS) for this PPPoE AC route.

Default No L2TP peer address is configured by default.

Mode PPPoE Access Concentrator Configuration

Example To configure L2TP to tunnel all users to the LNS located at IP address 192.168.11.2, use the commands:

```
awplus# configure terminal
awplus(config)# pppoe-ac ISP-service
awplus(cinfig-pppoe-ac)# l2tp peer-address static 192.168.11.2
```

To configure L2TP to tunnel all users to the LNS located at domain foo.mydomain.org, use the commands:

```
awplus# configure terminal
awplus(config)# pppoe-ac ISP-service
awplus(config-pppoe-ac)# l2tp peer-address static
foo.mydomain.org
```

To remove the configured peer (LNS) address, use the commands:

```
awplus# configure terminal
awplus(config)# pppoe-ac ISP-service
awplus(cinfig-pppoe-ac)# no l2tp peer-address
```

Related commands [destination l2tp](#)
[l2tp peer-address dns-lookup](#)
[l2tp peer-address radius-lookup group](#)

l2tp profile
ppp-auth-protocol
service-name
show running-config pppoe-ac

I2tp profile

Overview Use this command to set the profile to use for L2TP traffic for this PPPoE Access Concentrator (AC).

Use the **no** variant of this command to remove L2TP profile setting from this PPPoE AC.

Syntax `l2tp profile <l2tp-profile-name>`
`no l2tp profile <l2tp-profile-name>`

Parameter	Description
<code><l2tp-profile-name></code>	The name of the L2TP profile that the PPPoE AC is to use. to use.

Default This command is not configured by default.

Mode PPPoE Access Concentrator Configuration

Usage The L2TP profile name used in this command is created by the **l2tp-profile** command.

Example To allow AC service "ISP-service" to use the L2TP profile called "PUBLIC", use the commands:

```
awplus# configure terminal
awplus(config)# pppoe-ac ISP-service
awplus(config-pppoe-ac)# l2tp profile PUBLIC
```

To unset the L2TP profile for the AC service "ISP-service", use the commands:

```
awplus# configure terminal
awplus(config)# pppoe-ac ISP-service
awplus(config-pppoe-ac)# no l2tp profile PUBLIC
```

Related commands

- [destination l2tp](#)
- [l2tp-profile](#)
- [l2tp peer-address dns-lookup](#)
- [l2tp peer-address radius-lookup group](#)
- [l2tp peer-address static](#)
- [l2tp-profile](#)
- [pppoe-ac](#)
- [ppp-auth-protocol](#)
- [service-name](#)

`show running-config pppoe-ac`

max-sessions

Overview Use this command to configure the maximum concurrent sessions for a PPPoE relay instance.

Use the **no** variant of this command to set a PPPoE relay maximum concurrent sessions to the default value.

Syntax `max-sessions <1-65534>`
`no max-sessions`

Parameter	Description
<code><1-65534></code>	The maximum number of concurrent sessions per PPPoE relay instance.

Default 5000

Mode PPPoE Relay Configuration

Example To set the PPPoE relay maximum concurrent sessions to 50, use the commands:

```
awplus# configure terminal
awplus(config)# pppoe-relay Telco1
awplus(config-pppoe-relay)# max-sessions 50
```

To set the PPPoE relay maximum concurrent sessions to the default, use the commands:

```
awplus# configure terminal
awplus(config)# pppoe-relay Telco1
awplus(config-pppoe-relay)# no max-sessions
```

Related commands

- [client \(pppoe-relay\)](#)
- [server \(pppoe-relay\)](#)
- [timeout \(pppoe-relay\)](#)
- [pppoe-relay](#)
- [show running-config pppoe-relay](#)

Command changes Version 5.5.0-1.3: command added

ppp-auth-protocol

Overview Use this command to set the authentication protocol to be used for this PPPoE Access Concentrator (AC) service.

Use the **no** variant of this command to reset the authentication protocol to the default.

Syntax `ppp-auth-protocol {chap|pap|eap}`
`no ppp-auth-protocol`

Parameter	Description
chap	Set the PPP authentication protocol to Challenge Handshake Authentication Protocol (default).
pap	Set the PPP authentication protocol to Password Authentication Protocol.
eap	Set the PPP authentication protocol to Extensible Authentication Protocol.

Default Default PPP authentication protocol is CHAP.

Mode PPPoE Access Concentrator Configuration

Example To set PPP authentication for the PPPoE AC service 'ISP-service' to use PAP, use the commands:

```
awplus# configure terminal
awplus(config)# pppoe-ac ISP-service
awplus(config-pppoe-ac)# ppp-auth-protocol pap
```

To set PPP authentication to use the default (CHAP), use the commands:

```
awplus# configure terminal
awplus(config)# pppoe-ac ISP-service
awplus(config-pppoe-ac)# no ppp-auth-protocol
```

Related commands

- [destination l2tp](#)
- [l2tp peer-address dns-lookup](#)
- [l2tp peer-address radius-lookup group](#)
- [l2tp peer-address static](#)
- [l2tp profile](#)
- [pppoe-ac](#)
- [service-name](#)
- [show running-config pppoe-ac](#)

pppoe-ac

Overview Use this command to create a PPPoE Access Concentrator (AC) and put the device into PPPoE Access Concentrator Configuration mode, in which subsequent commands can be entered.

Use the **no** variant of this command to remove the PPPoE AC and all its configuration.

Syntax `pppoe-ac <label>`
`no pppoe-ac <label>`

Parameter	Description
<code><label></code>	A unique label for the PPPoE AC service.

Default No PPPoE AC services are configured by default.

Mode Global Configuration

Example To configure a PPPoE AC called "ISP-service", use the commands:

```
awplus# configure terminal
awplus(config)# pppoe-ac ISP-service
awplus(config-pppoe-ac)#
```

To remove a PPPoE AC called "ISP-service" and its configuration, use the commands:

```
awplus# configure terminal
awplus(config)# no pppoe-ac ISP-service
```

Related commands

- [destination l2tp](#)
- [l2tp peer-address dns-lookup](#)
- [l2tp peer-address radius-lookup group](#)
- [l2tp peer-address static](#)
- [l2tp profile](#)
- [pppoe-ac](#)
- [ppp-auth-protocol](#)
- [pppoe-ac-service](#)
- [service-name](#)
- [show running-config pppoe-ac](#)

pppoe-ac-service

Overview Use this command to attach the specified PPPoE Access Concentrator (AC) service to the interface. An AC service can be offered on several interfaces. Up to six PPPoE AC services can be set for one interface. Only ETH and VLAN interfaces accept this command.

Use the **no** variant of this command to remove the AC service from the interface.

Syntax `pppoe-ac-service <label>`
`no pppoe-ac-service <label>`

Parameter	Description
<label>	The name (label) of the PPPoE AC service to be attached to the interface.

Default No PPPoE AC service is attached to an interface by default.

Mode Interface Configuration

Usage notes The label of the PPPoE AC service specified in this command is created by the **pppoe-ac** command.

Example To provide a PPPoE AC service labeled 'ISP-service' for client requests received on interface eth1, use the commands:

```
awplus# configure terminal
awplus(config)# interface eth1
awplus(config-if)# pppoe-ac-service ISP-service
```

To remove the PPPoE AC service 'isp1' from interface eth1, use the commands:

```
awplus# configure terminal
awplus(config)# interface eth1
awplus(config-if)# no pppoe-ac-service isp1
```

Related commands [pppoe-ac](#)

pppoe-relay

Overview Use this command to create a PPPoE relay instance and put the device into PPPoE Relay Configuration mode, in which subsequent commands can be entered.

Use the **no** variant of this command to remove the PPPoE relay instance and all its configuration.

Syntax `pppoe-relay <relay-name>`
`no pppoe-relay <relay-name>`

Parameter	Description
<code><relay-name></code>	Name of the PPPoE relay instance

Default None.

Mode Global Configuration

Usage notes PPPoE relay tracks state information for multiple Layer 2 PPPoE sessions, and allows multiple PPPoE client connections to be relayed between one or more client LANs and a WAN.

This allows the PPPoE client connections to have access to one or more service provider PPPoE Access Concentrators - whilst at the same time allowing Layer 3 IP traffic routing from the internal LAN(s) to the Internet.

Use this command to first create a PPPoE relay instance, then add a client and server interface to the instance.

Example To configure a PPPoE relay instance, use the commands:

```
awplus# configure terminal
awplus(config)# pppoe-relay test
awplus(config-pppoe-relay)#
```

Related commands [client \(pppoe-relay\)](#)
[server \(pppoe-relay\)](#)
[timeout \(pppoe-relay\)](#)
[max-sessions](#)
[show running-config pppoe-relay](#)

Command changes Version 5.5.0-1.3: command added

proxy-auth

Overview Use this command to enable the proxy authentication to allow PPP authentication data to be collected and sent to an L2TP peer in additional L2TP AVPs when the L2TP session is established.

Use the **no** variant of this command to disable the proxy authentication.

Syntax proxy-auth
no proxy-auth

Default Proxy authentication is enabled by default.

Mode PPPoE Access Concentrator Configuration

Example To enable proxy authentication for the PPPoE AC service "ISP-service", use the commands:

```
awplus# configure terminal
awplus(config)# pppoe-ac ISP-service
awplus(config-pppoe-ac)# proxy-auth
```

Disable proxy authentication for PPPoE AC service "ISP-service:

```
awplus# configure terminal
awplus(config)# pppoe-ac ISP-service
awplus(config-pppoe-ac)# no proxy-auth
```

Related commands

- [destination l2tp](#)
- [l2tp peer-address dns-lookup](#)
- [l2tp peer-address radius-lookup group](#)
- [ppp-auth-protocol](#)
- [pppoe-ac-service](#)
- [service-name](#)
- [show running-config pppoe-ac](#)

server (pppoe-relay)

Overview Use this command to configure a PPPoE relay server interface.
Use the **no** variant of this command to remove a PPPoE relay server interface.

Syntax `server <server-interface>`
`no server <server-interface>`

Parameter	Description
<code><server-interface></code>	The PPPoE relay server interface. The valid interface types are: eth and vlan.

Default None.

Mode PPPoE Relay Configuration

Example To configure eth1 as the server interface on PPPoE relay instance 'Telco2', use the commands:

```
awplus# configure terminal
awplus(config)# pppoe-relay Telco2
awplus(config-pppoe-relay)# server eth1
```

To remove the eth1 server interface configured on PPPoE relay instance 'Telco2', use the commands:

```
awplus# configure terminal
awplus(config)# pppoe-relay Telco2
awplus(config-pppoe-relay)# no server eth1
```

Related commands [client \(pppoe-relay\)](#)
[timeout \(pppoe-relay\)](#)
[max-sessions](#)
[pppoe-relay](#)
[show running-config pppoe-relay](#)

Command changes Version 5.5.0-1.3: command added

service-name

Overview Use this command to configure the PPPoE service name offered by the Access Concentrator (AC).

Use the **no** variant of this command to remove the service offered by the AC.

Syntax `service-name {any|<service-name> [advertised]}`
`no service-name {any|<service-name>}`

Parameter	Description
<code><service-name></code>	The name of the service to be offered.
<code>any</code>	The service should be provided to any client requesting it, regardless of the service name they request.
<code>advertised</code>	Whether the service is advertised to other clients.

Default No PPPoE service is configured by default.

Mode PPPoE Access Concentrator Configuration

Example To set the PPPoE AC labelled 'ISP-service' to provide service to any client requesting it, regardless of the service name they request, use the commands:

```
awplus# configure terminal
awplus(config)# pppoe-ac ISP-service
awplus(config-pppoe-ac)# service-name any
```

To offer a private (unadvertised) PPPoE service "internet" and an advertised PPPoE service "remote-office" to a client, use the commands:

```
awplus# configure terminal
awplus(config)# pppoe-ac ISP-service
awplus(config-pppoe-ac)# service-name internet
awplus(config-pppoe-ac)# service-name remote-office advertised
```

To remove the non-matching (any) PPPoE service so that it is no longer offered to a client, use the commands:

```
awplus# configure terminal
awplus(config)# pppoe-ac ISP-service
awplus(config-pppoe-ac)# no service-name any
```

To remove the private PPPoE service "internet" and advertised service "remote-office", so they are no longer offered to a client, use the commands:

```
awplus# configure terminal
awplus(config)# pppoe-ac ISP-service
awplus(config-pppoe-ac)# no service-name internet
awplus(config-pppoe-ac)# no service-name remote-office
```

**Related
commands**

[destination l2tp](#)
[l2tp peer-address dns-lookup](#)
[l2tp peer-address radius-lookup group](#)
[l2tp peer-address static](#)
[l2tp profile](#)
[pppoe-ac](#)
[ppp-auth-protocol](#)
[show running-config pppoe-ac](#)

show debugging pppoe ac

Overview Use this command to display the status of the PPPoE AC debugging.

Syntax `show debugging pppoe ac`

Mode Privileged Exec

Usage notes Enable PPPoE AC debugging with the **debug pppoe-ac** command.

Example To display the status of PPPoE AC debugging, use the command:

```
awplus# show debugging pppoe ac
```

Output Figure 20-1: Example output from **show debugging pppoe ac**

```
awplus#show debugging pppoe ac
PPPoE-AC Debugging is on
```

Related commands [debug pppoe-ac](#)

show pppoe-ac config-check

Overview Use this command to display information about the validity of the configurations for PPPoE AC routes.

Syntax show pppoe-ac [*<label>*] config-check

Parameter	Description
<i><label></i>	The label for the PPPoE AC service.

Mode Privileged Exec

Example To display the validity of the configurations for all PPPoE AC services, use the command:

```
awplus# show pppoe-ac config-check
```

To display the validity of the configurations for the PPPoE AC labelled "ac1" only, use the command:

```
awplus# show pppoe-ac ac1 config-check
```

Output Figure 20-2: Example output from **show pppoe-ac config-check**

```
awplus#sh pppoe-ac config-check

PPPoE Access Concentrator ac:
  Incomplete Configuration
  Required: add pppoe-ac-service to one or more interfaces
  Required: destination
  Required: service-name
  Required: l2tp peer-address
  Required: l2tp profile

PPPoE Access Concentrator ac1:
  Incomplete Configuration
  Required: add pppoe-ac-service to one or more interfaces

PPPoE Access Concentrator pppoeservice:
  Complete Configuration
```

Table 20-1: Parameters in the output from **show pppoe-ac config-check**

Parameter	Description
Incomplete configuration	Further configuration is required to create a valid PPPoE AC service.

Table 20-1: Parameters in the output from **show pppoe-ac config-check** (cont.)

Parameter	Description
Complete configuration	There is sufficient configuration of this PPPoE AC service to be valid.
Required	Parameters that still need to be configured for this PPPoE AC service.

Related commands

[pppoe-ac](#)
[show running-config pppoe-ac](#)

show pppoe-ac connections

Overview Use this command to display information about current routes for the specified PPPoE Access Concentrator (AC) service or for all PPPoE AC services.

Syntax show pppoe-ac [*label*] connections

Parameter	Description
<i>label</i>	The label for the PPPoE AC service.

Mode User Exec and Privileged Exec

Example To display current routes information for all PPPoE AC services, use the command:

```
awplus# show pppoe-ac connections
```

To display information about connected routes for the PPPoE AC service 'pppoeservice' only, use the command:

```
awplus# show pppoe-ac pppoeservice connections
```

Output Figure 20-3: Example output from **show pppoe-ac connections**

```
awplus#show pppoe-ac connections
PPPoE Access Concentrator Connection Status
-----
Route Name: pppoeservice-eth1
Route ID: 29785
Source Information
  Interface: eth1
  Session ID: 14204
  Service Name: test
  State: Open
  Peer MAC: 00:00:cd:38:01:4f
Destination Information
  Type: L2TP
  Tunnel ID: 11223
  Session ID: 57309
```

Table 20-2: Parameters in the output from **show pppoe-ac connections**

Parameter	Description
Route Name	The name of the route.
Route ID	The ID of the route.
Source Information	Information about the source of the PPPoE route.

Table 20-2: Parameters in the output from **show pppoe-ac connections** (cont.)

Parameter	Description
Interface	The incoming interface name.
Session ID	The PPPoE session ID.
Service Name	The service name that this PPPoE AC is offering. This is the service name assigned by the service-name command.
State	The state of the PPPoE connection; e.g. open.
Peer MAC	The MAC address of the LNS.
Destination Information	Information about the destination for this PPPoE route.
Type	The type of destination of this PPPoE connection, for example, L2TP.
Tunnel ID	The ID of the L2TP tunnel.
Session ID	The ID of the PPPoE session.

Related commands [pppoe-ac](#)

show pppoe-ac statistics

Overview Use this command to displays the statistics for the PPPoE Access Concentrator (AC).

Syntax show pppoe-ac statistics

Mode Privileged Exec

Example To display statistics for PPPoE AC, use the command:

```
awplus# show pppoe-ac statistics
```

Output Figure 20-4: Example output from **show pppoe-ac statistics**

```
awplus#sh pppoe-ac statistics
PPPoE Access Concentrator Statistics
Name                                     Value
-----
lnsLookupSuccessfulRequests             0
lnsLookupFailedRequests                 0
lnsLookupDnsFailures                    0
lnsLookupRadiusFailures                 0
l2tpTunnelsOpened                       2
l2tpSessionsOpened                      2
l2tpSessionsClosed                      0
l2tpDnsFailures                         0
pppoePadiReceived                       2
pppoeInvalidPadi                        0
pppoePadoSent                           2
pppoePadsSent                           2
pppoePadrReceived                       2
pppoeInvalidPadr                        0
pppoeResentPadr                         0
pppoePadtReceived                       0
pppoeInvalidPadt                        0
pppoePadtSent                           0
routesCreated                           2
routesCreateFail                        0
routesDeleted                           0
routesDeleteFail                        0
routesDstOpenFail                       0
routesDestCloseFail                     0
routesSourceCloseFail                   0
routesClosedByDest                      0
routesClosedBySource                     0
```

Table 20-3: Parameters in the output from **show pppoe-ac statistic**

Parameter	Description
lnsLookupSuccessfulRequests	The number of successful LNS address lookup requests.
lnsLookupFailedRequests	The number of failed LNS address lookup requests.
lnsLookupDnsFailures	The number of LNS address DNS lookup failures.
lnsLookupRadiusFailures	The number of LNS address RADIUS lookup failures.
l2tpTunnelsOpened	The number of L2TP tunnels opened.
l2tpSessionsOpened	The number of L2TP sessions opened.
l2tpSessionsClosed	The number of L2TP sessions closed.
l2tpDnsFailures	The number of L2TP DNS lookup failures.
pppoePadiReceived	The number of PADI packets received.
pppoeInvalidPadi	The number of invalid PADI packets received.
pppoePadoSent	The number of PADO packets sent.
pppoePadsSent	The number of PADS packets sent.
pppoePadrReceived	The number of PADR packets received.
pppoeInvalidPadr	The number of invalid PADR packets received.
pppoeResentPadr	The number of resent PADR packets received.
pppoePadtReceived	The number of PADT packets received.
pppoeInvalidPadt	The number of invalid PADT packets received.
pppoePadtSent	The number of PADT packets sent.
routesCreated	The number of routes created.
routesCreateFail	The number of route create failures.
routesDeleted	The number of routes deleted.
routesDeleteFail	The number of route delete failures.
routesDstOpenFail	The number of destination open failures.

Table 20-3: Parameters in the output from **show pppoe-ac statistic** (cont.)

Parameter	Description
routesDestCloseFail	The number of destination close failures.
routesSourceCloseFail	The number of source close failures.
routesClosedByDest	The number of routes closed by the destination.
routesClosedBySource	The number of routes closed by the source.

Related commands [clear pppoe-ac statistics](#)
[pppoe-ac](#)

show running-config pppoe-ac

Overview Use this command to display the PPPoE Access Concentrator (AC) running configuration.

Syntax `show running-config pppoe-ac`

Mode Privileged Exec

Example To display the running configuration for the PPPoE AC, use the command:

```
awplus# running-config pppoe-ac
```

Output Figure 20-5: Example output from **show running-config pppoe-ac**

```
awplus#show running-config pppoe-ac
pppoe-ac-service ISP-service
  service-name remote-office advertised
  ppp-auth-protocols pap
  destination l2tp
  l2tp peer-address static 192.168.11.2
  l2tp profile PUBLIC
```

Related commands

[destination l2tp](#)
[l2tp peer-address dns-lookup](#)
[l2tp peer-address radius-lookup group](#)
[l2tp peer-address static](#)
[l2tp profile](#)
[pppoe-ac](#)
[ppp-auth-protocol](#)
[proxy-auth](#)
[service-name](#)
[show pppoe-ac config-check](#)

show running-config pppoe-relay

Overview Use this command to display the running configuration for PPPoE relay.

Syntax `show running-config pppoe-relay [<relay-name>]`

Parameter	Description
<code><relay-name></code>	Name of the PPPoE relay instance.

Default None.

Mode Privileged Exec

Example To show all PPPoE relay configurations, use the command:

```
awplus# show running-config pppoe-relay
```

To show the PPPoE relay configuration for Telco1, use the command:

```
awplus# show running-config pppoe-relay Telco1
```

Output Figure 20-6: Example output from **show running-config pppoe-relay**

```
awplus#show running-config pppoe-relay
pppoe-relay Telco1
  client eth2
  server vlan4
  max-sessions 50
  timeout 100
!
pppoe-relay Telco2
  client eth1
  server vlan1
!
```

Related commands

- [client \(pppoe-relay\)](#)
- [server \(pppoe-relay\)](#)
- [timeout \(pppoe-relay\)](#)
- [max-sessions](#)
- [pppoe-relay](#)

Command changes Version 5.5.0-1.3: command added

timeout (pppoe-relay)

Overview Use this command to configure the PPPoE relay idle session timeout.
Use the **no** variant of this command to set the PPPoE relay idle session timeout to the default value.

Syntax `timeout {0|<30-86400>}`
`no timeout`

Parameter	Description
0	Sets the idle session timeout to never terminate PPPoE relay sessions.
<30-86400>	The PPPoE relay idle session timeout in seconds.

Default 600 seconds.

Mode PPPoE Relay Configuration

Example To set the PPPoE relay idle session timeout to 30 minutes, use the commands:

```
awplus# configure terminal
awplus(config)# pppoe-relay Telco1
awplus(config-pppoe-relay)# timeout 1800
```

To set the PPPoE relay idle session timeout to never timeout, use the commands:

```
awplus# configure terminal
awplus(config)# pppoe-relay Telco1
awplus(config-pppoe-relay)# timeout 0
```

To set the PPPoE relay idle session timeout to the default value, use the commands:

```
awplus# configure terminal
awplus(config)# pppoe-relay Telco1
awplus(config-pppoe-relay)# no timeout
```

Related commands [client \(pppoe-relay\)](#)
[server \(pppoe-relay\)](#)
[max-sessions](#)
[pppoe-relay](#)
[show running-config pppoe-relay](#)

Command changes Version 5.5.0-1.3: command added

Part 3: Routing

21

IP Addressing and Protocol Commands

Introduction

Overview This chapter provides an alphabetical reference of commands used to configure various IP features, including the following protocols:

- Address Resolution Protocol (ARP)

For more information, see the [IP Feature Overview and Configuration Guide](#).

- Command List**
- [“arp-aging-timeout”](#) on page 744
 - [“arp”](#) on page 745
 - [“arp log”](#) on page 747
 - [“arp opportunistic-nd”](#) on page 750
 - [“arp-loose-check”](#) on page 752
 - [“arp-reply-bc-dmac”](#) on page 754
 - [“clear arp-cache”](#) on page 755
 - [“debug ip packet interface”](#) on page 757
 - [“ip address \(IP Addressing and Protocol\)”](#) on page 759
 - [“ip directed-broadcast”](#) on page 761
 - [“ip forwarding”](#) on page 763
 - [“ip forward-protocol udp”](#) on page 764
 - [“ip gratuitous-arp-link”](#) on page 766
 - [“ip helper-address”](#) on page 768
 - [“ip icmp error-interval”](#) on page 770
 - [“ip icmp-timestamp”](#) on page 771
 - [“ip limited-local-proxy-arp”](#) on page 772
 - [“ip local-proxy-arp”](#) on page 774

- ["ip proxy-arp"](#) on page 775
- ["ip redirects"](#) on page 776
- ["ip tcp synack-retries"](#) on page 777
- ["ip tcp timeout established"](#) on page 778
- ["ip tcp-timestamp"](#) on page 779
- ["ip unreachable"](#) on page 780
- ["local-proxy-arp"](#) on page 782
- ["optimistic-nd"](#) on page 783
- ["ping"](#) on page 784
- ["show arp"](#) on page 786
- ["show debugging ip packet"](#) on page 788
- ["show ip flooding-next hops"](#) on page 789
- ["show ip forwarding"](#) on page 790
- ["show ip interface"](#) on page 791
- ["show ip interface vrf"](#) on page 792
- ["show ip sockets"](#) on page 794
- ["show ip traffic"](#) on page 797
- ["tcpdump"](#) on page 799
- ["traceroute"](#) on page 800
- ["undebbug ip packet interface"](#) on page 801

arp-aging-timeout

Overview This command sets a timeout period on dynamic ARP entries associated with a specific interface. If your device stops receiving traffic for the host specified in a dynamic ARP entry, it deletes the ARP entry from the ARP cache after this timeout is reached.

Your device times out dynamic ARP entries to ensure that the cache does not fill with entries for hosts that are no longer active. Static ARP entries are not aged or automatically deleted.

By default the time limit for dynamic ARP entries is 300 seconds on all interfaces. The **no** variant of this command sets the time limit to the default of 300 seconds.

Syntax `arp-aging-timeout <0-432000>`
`no arp-aging timeout`

Parameter	Description
<code><0-432000></code>	The timeout period in seconds.

Default 300 seconds (5 minutes)

Mode Interface Configuration for a VLAN interface.

Example To set the ARP entries on interface vlan2 to time out after two minutes, use the commands:

```
awplus# configure terminal
awplus(config)# interface vlan2
awplus(config-if)# arp-aging-timeout 120
```

Related commands [clear arp-cache](#)
[show arp](#)

arp

Overview This command adds a static ARP entry to the ARP cache. This is typically used to add entries for hosts that do not support ARP or to speed up the address resolution function for a host. The ARP entry must not already exist. Use the **alias** parameter to allow your device to respond to ARP requests for this IP address.

If VRF-lite is configured, you can add ARP entries to either the global cache or for a specific VRF instance.

The **no** variant of this command removes the static ARP entry. Use the **clear arp-cache** command to remove the dynamic ARP entries in the ARP cache.

Syntax `arp <ip-addr> <mac-address> [alias]`
`no arp <ip-addr>`

Syntax (VRF-lite) `arp [vrf <vrf-name>] <ip-addr> <mac-address> [<port-number>]`
`[alias]`
`no arp [vrf <vrf-name>] <ip-addr>`

Parameter	Description
<code><ip-addr></code>	The IPv4 address of the device you are adding as a static ARP entry.
<code><mac-address></code>	The MAC address of the device you are adding as a static ARP entry, in hexadecimal notation with the format HHHH.HHHH.HHHH.
<code>alias</code>	Allows your device to respond to ARP requests for the IP address. Proxy ARP must be enabled on the interface before using this parameter.
<code>vrf</code>	Apply this command to a VRF instance.
<code><vrf-name></code>	The name of the VRF instance.

Mode Global Configuration

Examples To add the IP address 10.10.10.9 with the MAC address 0010.2533.4566 into the ARP cache, and have your device respond to ARP requests for this address, use the commands:

```
awplus# configure terminal
awplus(config)# arp 10.10.10.9 0010.2533.4566 alias
```

Example (VRF-lite) To apply the above example within a VRF instance called `red` use the following commands:

```
awplus# configure terminal
awplus(config)# arp vrf red 10.10.10.9 0010.2533.4566 alias
```

Related commands `clear arp-cache`
`ip proxy-arp`
`show arp`

Command changes Version 5.4.6-2.1: VRF-lite support added.

arp log

Overview This command enables the logging of dynamic and static ARP entries in the ARP cache. The ARP cache contains mappings of device ports, VLAN IDs, and IP addresses to physical MAC addresses for hosts.

This command can display the MAC addresses in the ARP log either using the notation HHHH.HHHH.HHHH, or using the IEEE standard hexadecimal notation (HH-HH-HH-HH-HH-HH).

Use the **no** variant of this command to disable the logging of ARP entries.

Syntax `arp log [mac-address-format ieee]`
`no arp log [mac-address-format ieee]`

Parameter	Description
<code>mac-address-format ieee</code>	Display the MAC address in the standard IEEE format (HH-HH-HH-HH-HH-HH), instead of displaying the MAC address with the format HHHH.HHHH.HHHH.

Default The ARP logging feature is disabled by default.

Mode Global Configuration

Usage notes You have the option to change how the MAC address is displayed in the ARP log message. The output can either use the notation HHHH.HHHH.HHHH or HH-HH-HH-HH-HH-HH.

Enter **arp log** to use HHHH.HHHH.HHHH notation.

Enter **arp log mac-address-format ieee** to use HH-HH-HH-HH-HH-HH notation.

Enter **no arp log mac-address-format ieee** to revert from HH-HH-HH-HH-HH-HH to HHHH.HHHH.HHHH.

Enter **no arp log** to disable ARP logging.

To display ARP log messages use the command **show log | include ARP_LOG**.

Examples To enable ARP logging and specify that the MAC address in the log message is displayed in HHHH.HHHH.HHHH notation, use the following commands:

```
awplus# configure terminal
awplus(config)# arp log
```

To disable ARP logging on the device, use the following commands:

```
awplus# configure terminal
awplus(config)# no arp log
```

To enable ARP logging and specify that the MAC address in the log message is displayed in the standard IEEE format hexadecimal notation (HH-HH-HH-HH-HH-HH), use the following commands:

```
awplus# configure terminal
awplus(config)# arp log mac-address-format ieee
```

To leave ARP logging enabled, but stop using HH-HH-HH-HH-HH-HH format and use HHHH.HHHH.HHHH format instead, use the following commands:

```
awplus# configure terminal
awplus(config)# no arp log mac-address-format ieee
```

To display ARP log messages, use the following command:

```
awplus# show log | include ARP_LOG
```

Output Figure 21-1: Output from **show log | include ARP_LOG** after enabling ARP logging using **arp log**. Note that this output uses HHHH.HHHH.HHHH format.

```
awplus#configure terminal
awplus(config)#arp log
awplus(config)#exit
awplus#show log | include ARP_LOG
2022 Mar 6 06:21:01 user.notice awplus HSL[1007]: ARP_LOG port1.0.1 vlan1 add
0013.4078.3b98 (192.168.2.4)
2022 Mar 6 06:22:30 user.notice awplus HSL[1007]: ARP_LOG port1.0.1 vlan1 del
0013.4078.3b98 (192.168.2.4)
2022 Mar 6 06:23:26 user.notice awplus HSL[1007]: ARP_LOG port1.0.1 vlan1 add
0030.940e.136b (192.168.2.20)
2022 Mar 6 06:23:30 user.notice awplus IMISH[1830]: show log | include ARP_LOG
```

Figure 21-2: Output from **show log | include ARP_LOG** after enabling ARP logging using **arp log mac-address format ieee**. Note that this output uses HH-HH-HH-HH-HH-HH format.

```
awplus#configure terminal
awplus(config)#arp log mac-address-format ieee
awplus(config)#exit
awplus#show log | include ARP_LOG
2022 Mar 6 06:25:28 user.notice awplus HSL[1007]: ARP_LOG port1.0.1 vlan1 add
00-17-9a-b6-03-69 (192.168.2.12)
2022 Mar 6 06:25:30 user.notice awplus HSL[1007]: ARP_LOG port1.0.1 vlan1 add
00-03-37-6b-a6-a5 (192.168.2.10)
2022 Mar 6 06:26:53 user.notice awplus HSL[1007]: ARP_LOG port1.0.1 vlan1 del
00-30-94-0e-13-6b (192.168.2.20)
2022 Mar 6 06:27:31 user.notice awplus HSL[1007]: ARP_LOG port1.0.1 vlan1 del
00-17-9a-b6-03-69 (192.168.2.12)
2022 Mar 6 06:28:09 user.notice awplus HSL[1007]: ARP_LOG port1.0.1 vlan1 del
00-03-37-6b-a6-a5 (192.168.2.10)
2022 Mar 6 06:28:14 user.notice awplus IMISH[1830]: show log | include ARP_LOG
```

The following table lists the parameters shown in the output of the **show log | include ARP_LOG** command. The ARP log message format is:

```
<date> <time> <severity> <hostname> <program-name>  
ARP_LOG <port-number> <vid> <operation> <MAC> <IP>
```

Table 21-1: Parameters in the output from **show log | include ARP_LOG**

Parameter	Description
ARP_LOG	Indicates that ARP log entry information follows.
<operation>	Indicates "add" if the ARP log entry displays an ARP addition. Indicates "del" if the ARP log entry displays an ARP deletion.
<MAC>	Indicates the MAC address for the ARP log entry, either in the default hexadecimal notation (HHHH.HHHH.HHHH) or in the IEEE standard format hexadecimal notation (HH-HH-HH-HH-HH-HH) as specified with the arp log or the arp log mac-address-format ieee command.
<IP>	Indicates the IP address for the ARP log entry.

Related commands [show log](#)
[show running-config](#)

arp opportunistic-nd

Overview Use this command to enable opportunistic neighbor discovery for the global ARP cache. This command changes the behavior for unsolicited ARP packet forwarding on the device.

CAUTION: *Opportunistic neighbor discovery can make your device more vulnerable to ARP/ND cache poisoning attacks. We recommend disabling it unless necessary.*

When using VRF-lite, you can use this command to enable opportunistic neighbor discovery for a named VRF instance.

Use the **no** variant of this command to disable opportunistic neighbor discovery for the global ARP cache.

Syntax `arp opportunistic-nd`
`no arp opportunistic-nd`

Syntax (VRF-lite) `arp opportunistic-nd [vrf <vrf-name>]`
`no arp opportunistic-nd [vrf <vrf-name>]`

Parameter	Description
<code>vrf</code>	Apply this command to a VRF instance.
<code><vrf-name></code>	The name of the VRF instance.

Default Opportunistic neighbor discovery is disabled by default.

Mode Global Configuration

Usage notes When opportunistic neighbor discovery is enabled, the device will reply to any received unsolicited ARP packets (but not gratuitous ARP packets). The source MAC address for the unsolicited ARP packet is added to the ARP cache, so the device forwards the ARP packet. When opportunistic neighbor discovery is disabled, the source MAC address for the ARP packet is not added to the ARP cache, so the ARP packet is not forwarded by the device.

Note this command enables or disables opportunistic neighbor discovery for a VRF instance if the **vrf** parameter and an instance name are applied. If a VRF instance is not specified, then opportunistic neighbor discovery is enabled or disabled for device ports configured for IPv4.

Examples To enable opportunistic neighbor discovery for the global ARP cache, enter:

```
awplus# configure terminal
awplus(config)# arp opportunistic-nd
```

To disable opportunistic neighbor discovery for the global ARP cache, enter:

```
awplus# configure terminal
awplus(config)# no arp opportunistic-nd
```

Example (VRF-lite) To enable opportunistic neighbor discovery for the VRF instance 'blue', enter:

```
awplus# configure terminal
awplus(config)# arp opportunistic-nd vrf blue
```

To disable opportunistic neighbor discovery for the VRF instance 'blue', enter:

```
awplus# configure terminal
awplus(config)# no arp opportunistic-nd vrf blue
```

Related commands

- ipv6 opportunistic-nd
- show arp
- show running-config interface

Command changes Version 5.4.6-2.1: VRF-lite support added.

arp-loose-check

Overview Use this command to let AlliedWare Plus process ARPs that have a sender protocol address from outside the interface's local subnets.

Use the **no** variant of this command to return to the default ARP processing behavior. By default, AlliedWare Plus will only process ARP packets that are local to the incoming interface.

Syntax `arp-loose-check`
`no arp-loose-check`

Default Disabled.

Mode Interface Configuration for VLAN, Eth, WWAN, L2TP tunnel, Multipoint VPN GRE, and bridge interfaces and 802.1Q sub-interfaces.

Usage notes By default, AlliedWare Plus will only process ARP packets that are local to the incoming interface, to prevent ARP poisoning. This means the packets must have:

- a sender protocol address inside one of the incoming interface's local subnets, and
- a target protocol address equal to one of the incoming interface's IP addresses.

If you enable loose ARP processing and then use the **no** variant of this command to return to default processing, you may need to clear the ARP cache. Use the [clear arp-cache](#) command. This will remove any undesired existing ARPs.

You cannot use this command at the same time as Proxy ARP. Proxy ARP also allows AlliedWare Plus to process ARPs that have a sender protocol address from outside the interface's local subnets.

Example To process ARPs that have a sender protocol address from outside vlan2's local subnets, use the commands:

```
awplus# configure terminal
awplus(config)# interface vlan2
awplus(config-if)# arp-loose-check
```

To return to the default behavior on vlan2, use the commands:

```
awplus# configure terminal
awplus(config)# interface vlan2
awplus(config-if)# no arp-loose-check
```

Related commands

- [arp](#)
- [clear arp-cache](#)
- [ip proxy-arp](#)
- [show arp](#)

Command changes Version 5.5.2-0.1: command added

arp-reply-bc-dmac

Overview Use this command to allow processing of ARP replies that arrive with a broadcast destination MAC (ffff.ffff.ffff). This makes neighbors reachable if they send ARP responses that contain a broadcast destination MAC.

Use the **no** variant of this command to turn off processing of ARP replies that arrive with a broadcast destination MAC.

Syntax `arp-reply-bc-dmac`
`no arp-reply-bc-dmac`

Default By default, this functionality is disabled.

Mode Interface Configuration for VLAN, Eth, WWAN, L2TP tunnel, Multipoint VPN GRE, and bridge interfaces and 802.1Q sub-interfaces.

Example To allow processing of ARP replies that arrive on vlan2 with a broadcast destination MAC, use the commands:

```
awplus# configure terminal
awplus(config)# interface vlan2
awplus(config-if)# arp-reply-bc-dmac
```

Related commands `clear arp-cache`
`show arp`

clear arp-cache

Overview This command deletes dynamic ARP entries from the ARP cache. You can optionally specify the IPv4 address of an ARP entry to be cleared from the ARP cache.

When running VRF-lite, this command deletes dynamic ARP entries either from the ARP cache of a specific VRF instance, or from the ARP cache of the Global VRF instance. To delete all ARP entries from both the Global VRF instance and all VRF instances, use the command with no parameters. You can optionally specify the IPv4 address for the VRF instance to clear an ARP entry from the ARP cache.

Syntax `clear arp-cache [<ip-address>]`

Syntax (VRF-lite) `clear arp-cache [vrf <vrf-name>|global] [<ip-address>]`

Parameter	Description
<ip-address>	Specifies a specific IPv4 address for a VRF instance whose entries are to be cleared from the ARP cache.
global	When VRF-lite is configured, apply this command to the global routing and forwarding table.
vrf	Apply this command to the specified VRF instance.
<vrf-name>	The VRF instance name.

Mode Privileged Exec

Usage notes To display the entries in the ARP cache, use the [show arp](#) command. To remove static ARP entries, use the no variant of the [arp](#) command.

Example To clear all dynamic ARP entries, use the command:

```
awplus# clear arp-cache
```

To clear all dynamic ARP entries associated with the IPv4 address 192.168.1.1, use the command:

```
awplus# clear arp-cache 192.168.1.1
```

Example (VRF-lite) To clear the dynamic ARP entries from the VRF instance named blue, use the commands:

```
awplus# clear arp-cache vrf blue
```

To clear the dynamic ARP entries from the VRF instance named blue with the IPv4 address 192.168.1.1, use the commands:

```
awplus# clear arp-cache vrf blue 192.168.1.1
```

When running VRF-lite, to clear the dynamic ARP entries from the global VRF-lite and all VRF instances, use the command:

```
awplus# clear arp-cache
```

**Related
commands**

[arp](#)

[show arp](#)

debug ip packet interface

Overview The **debug ip packet interface** command enables IP packet debug and is controlled by the **terminal monitor** command.

If the optional **icmp** keyword is specified then ICMP packets are shown in the output.

The **no** variant of this command disables the **debug ip packet interface** command.

Syntax

```
debug ip packet interface {<interface-name>|all} [address <ip-address>|verbose|hex|arp|udp|tcp|icmp]
no debug ip packet interface [<interface-name>]
```

Parameter	Description
<interface-name>	Specify a single Layer 3 interface name (not a range of interfaces) This keyword can be specified as either all or as a single Layer 3 interface to show debugging for either all interfaces or a single interface.
all	Specify all Layer 3 interfaces on the device.
<ip-address>	Specify an IPv4 address. If this keyword is specified, then only packets with the specified IP address as specified in the ip-address placeholder are shown in the output.
verbose	Specify verbose to output more of the IP packet. If this keyword is specified then more of the packet is shown in the output.
hex	Specify hex to output the IP packet in hexadecimal. If this keyword is specified, then the output for the packet is shown in hex.
arp	Specify arp to output ARP protocol packets. If this keyword is specified, then ARP packets are shown in the output.
udp	Specify udp to output UDP protocol packets. If this keyword is specified then UDP packets are shown in the output.
tcp	Specify tcp to output TCP protocol packets. If this keyword is specified, then TCP packets are shown in the output.
icmp	Specify icmp to output ICMP protocol packets. If this keyword is specified, then ICMP packets are shown in the output.

Mode Privileged Exec and Global Configuration

Examples To turn on ARP packet debugging on vlan2, use the command:

```
awplus# debug ip packet interface vlan2 arp
```

To turn off IP packet interface debugging on interface vlan2, use the command:

```
awplus# no debug ip packet interface vlan2
```

To turn on all packet debugging on all interfaces on the device, use the command:

```
awplus# debug ip packet interface all
```

To turn off IP packet interface debugging on all interfaces, use the command:

```
awplus# no debug ip packet interface
```

To turn on TCP packet debugging on vlan2 and IP address 192.168.2.4, use the command:

```
awplus# debug ip packet interface vlan2 address 192.168.2.4 tcp
```

**Related
commands**

[no debug all](#)

[show debugging ip dns forwarding](#)

[tcpdump](#)

[terminal monitor](#)

[undebug ip packet interface](#)

ip address (IP Addressing and Protocol)

Overview This command sets a static IP address on an interface.

The **no** variant of this command removes the IP address from the interface.

You cannot remove the primary address when a secondary address is present.

Syntax `ip address <ip-addr/prefix-length> [secondary] [label <label>]`
`no ip address [<ip-addr/prefix-length>] [secondary]`

Parameter	Description
<ip-addr/prefix-length>	The IPv4 address and prefix length you are assigning to the interface.
secondary	Secondary IP address.
label	Adds a user-defined description of the secondary IP address.
<label>	A user-defined description of the secondary IP address. Valid characters are any printable character and spaces.

Mode Interface Configuration for a VLAN interface, an Eth interface, an 802.1Q sub-interface, a local loopback interface, a PPP interface, a bridge, or a tunnel.

Usage notes To set the primary IP address on the interface, specify only **ip address** <ip-addr/prefix-length>. This overwrites any configured primary IP address. To add additional IP addresses on this interface, use the **secondary** parameter. You must configure a primary address on the interface before configuring a secondary address.

NOTE: Use **show running-config interface**, instead of **show ip interface brief**, when you need to view a secondary address configured on an interface. **show ip interface brief** will only show the primary address, not a secondary address for an interface.

Examples To add the IP address 10.10.10.50/24 to the interface vlan2, use the following commands:

```
awplus# configure terminal
awplus(config)# interface vlan2
awplus(config-if)# ip address 10.10.10.50/24
```

To add the secondary IP address 10.10.11.50/24 to the same interface, use the following commands:

```
awplus# configure terminal
awplus(config)# interface vlan2
awplus(config-if)# ip address 10.10.11.50/24 secondary
```

To add the IP address 10.10.11.50/24 to the local loopback interface lo, use the following commands:

```
awplus# configure terminal
awplus(config)# interface lo
awplus(config-if)# ip address 10.10.11.50/24
```

To add the IP address 10.10.11.50/24 to the PPP interface ppp0, use the following commands:

```
awplus# configure terminal
awplus(config)# interface ppp0
awplus(config-if)# ip address 10.10.11.50/24
```

To add the IP address 10.10.11.50/24 to the tunnel tunnel0, use the following commands:

```
awplus# configure terminal
awplus(config)# interface tunnel0
awplus(config-if)# ip address 10.10.11.50/24
```

**Related
commands**

[interface \(to configure\)](#)
[show ip interface](#)
[show running-config interface](#)

ip directed-broadcast

Overview Use this command to enable flooding of directed broadcast packets into a directly connected subnet. If this command is configured on an interface, then directed broadcasts received on other interfaces, destined for the subnet on this interface, will be flooded to the subnet broadcast address of this interface.

Use the **no** variant of this command to disable **ip directed-broadcast**. When this feature is disabled using the **no** variant of this command, directed broadcasts are not forwarded.

Syntax `ip directed-broadcast`
`no ip directed-broadcast`

Default The **ip directed-broadcast** command is disabled by default.

Mode Interface Configuration for a VLAN interface, an Eth interface, an 802.1Q sub-interface, a local loopback interface, a PPP interface, a bridge, or a tunnel.

Usage notes IP directed-broadcast is enabled and disabled per interface. When enabled a directed broadcast packet is forwarded to an enabled interface if received on another subnet.

An IP directed broadcast is an IP packet whose destination address is a broadcast address for some IP subnet, but originates from a node that is not itself part of that destination subnet. When a directed broadcast packet reaches a device that is directly connected to its destination subnet, that packet is flooded as a broadcast on the destination subnet.

The **ip directed-broadcast** command controls the flooding of directed broadcasts when they reach target subnets. The command affects the final transmission of the directed broadcast on its destination subnet. It does not affect the transit unicast routing of IP directed broadcasts. If directed broadcast is enabled for an interface, incoming directed broadcast IP packets intended for the subnet assigned to the interface will be flooded as broadcasts on that subnet.

If the **no ip directed-broadcast** command is configured for an interface, directed broadcasts destined for the subnet where the interface is attached will be dropped instead of broadcast.

Examples To enable the flooding of broadcast packets via the interface eth1, use the following commands:

```
awplus# configure terminal
awplus(config)# interface eth1
awplus(config-if)# ip directed-broadcast
```

To disable the flooding of broadcast packets via the interface eth1, use the following commands:

```
awplus# configure terminal
awplus(config)# interface eth1
awplus(config-if)# no ip directed-broadcast
```

Related commands

- [ip forward-protocol udp](#)
- [ip helper-address](#)
- [show running-config](#)

ip forwarding

Overview This command enables IP forwarding on your device. When enabled, your device routes IP packets.

The **no** variant of this command disables IP forwarding on your device. Even when IP forwarding is not enabled, the device can still work as an IP host; in particular, it can be managed by IP-based applications, such as SNMP, Telnet and SSH.

Syntax `ip forwarding`
`no ip forwarding`

Default IP forwarding is enabled by default.

Mode Global Configuration

Examples To enable your device to route IP packets, use the commands:

```
awplus# configure terminal
awplus(config)# ip forwarding
```

To stop your device from routing IP packets, use the commands

```
awplus# configure terminal
awplus(config)# no ip forwarding
```

Related commands [show ip forwarding](#)

ip forward-protocol udp

Overview This command enables you to control which UDP broadcasts will be forwarded to the helper address(es). A UDP broadcast will only be forwarded if the destination UDP port number in the packet matches one of the port numbers specified using this command.

Refer to the IANA site (www.iana.org) for a list of assigned UDP port numbers for protocols to forward using **ip forward-protocol udp**.

Use the **no** variant of this command to remove a port number from the list of destination port numbers that are used as the criterion for deciding if a given UDP broadcast should be forwarded to the IP helper address(es).

Syntax `ip forward-protocol udp <port>`
`no ip forward-protocol udp <port>`

Parameter	Description
<port>	UDP Port Number.

Default The **ip forward-protocol udp** command is not enabled by default.

Mode Global Configuration

Usage notes Combined with the **ip helper-address** command in interface mode, the **ip forward-protocol udp** command in Global Configuration mode allows control of which protocols (destination port numbers) are forwarded. The **ip forward-protocol udp** command configures protocols for forwarding, and the **ip helper-address** command configures the destination address(es).

NOTE:

*The types of UDP broadcast packets that the device will forward are ONLY those specified by the **ip forward-protocol** command(s). There are no other UDP packet types that the IP helper process forwards by default.*

Examples To configure forwarding of packets on a UDP port, use the following commands:

```
awplus# configure terminal
awplus(config)# ip forward-protocol udp <port>
```

To delete a UDP port from the UDP ports that the device forwards, use the following commands:

```
awplus# configure terminal
awplus(config)# no ip forward-protocol udp <port>
```

**Related
commands** [ip helper-address](#)
[ip directed-broadcast](#)
[show running-config](#)

ip gratuitous-arp-link

Overview This command sets the Gratuitous ARP time limit for all interfaces. The time limit restricts the sending of Gratuitous ARP packets to one Gratuitous ARP packet within the time in seconds.

The **no** variant of the command sets the Gratuitous ARP time limit to the default.

NOTE: This command specifies time between sequences of Gratuitous ARP packets, and time between individual Gratuitous ARP packets occurring in a sequence, to allow legacy support for older devices and inter-operation between other devices that are not ready to receive and forward data until several seconds after linkup.

Additionally, jitter has been applied to the delay following linkup, so Gratuitous ARP packets applicable to a given port are spread over a period of 1 second so are not all sent at once. Remaining Gratuitous ARP packets in the sequence occur after a fixed delay from the first one.

Syntax ip gratuitous-arp-link <0-300>
no ip gratuitous-arp-link

Parameter	Description
<0-300>	Specify the minimum time between sequences of Gratuitous ARPs and the fixed time between Gratuitous ARPs occurring in a sequence, in seconds. 0 disables the sending of Gratuitous ARP packets. The default is 8 seconds.

Default The default Gratuitous ARP time limit for all interfaces is 8 seconds.

Mode Global Configuration

Usage Every switchport will send a sequence of 3 Gratuitous ARP packets to each VLAN that the switchport is a member of, whenever the switchport moves to the forwarding state. The first Gratuitous ARP packet is sent 1 second after the switchport becomes a forwarding switchport. The second and third Gratuitous ARP packets are each sent after the time period specified by the Gratuitous ARP time limit.

Additionally, the Gratuitous ARP time limit specifies the minimum time between the end of one Gratuitous ARP sequence and the start of another Gratuitous ARP sequence. When a link is flapping, the switchport's state is set to forwarding several times. The Gratuitous ARP time limit is imposed to prevent Gratuitous ARP packets from being sent undesirably often.

Examples To disable the sending of Gratuitous ARP packets, use the commands :

```
awplus# configure terminal
awplus(config)# ip gratuitous-arp-link 0
```

To restrict the sending of Gratuitous ARP packets to one every 20 seconds, use the commands:

```
awplus# configure terminal
awplus(config)# ip gratuitous-arp-link 20
```

**Related
Commands** [show running-config](#)

ip helper-address

Overview Use this command to add a forwarding destination address for IP Helper to enable forwarding of User Datagram Protocol (UDP) broadcasts on an interface.

Use the **no** variant of this command to disable the forwarding of broadcast packets to specific addresses.

Syntax `ip helper-address <ip-addr>`
`no ip helper-address <ip-addr>`

Parameter	Description
<code><ip-addr></code>	Forwarding destination IP address for IP Helper.

Default The destination address for the **ip helper-address** command is not configured by default.

Mode Interface Configuration for a VLAN interface, an Eth interface, an 802.1Q sub-interface, a local loopback interface, a PPP interface, a bridge, or a tunnel.

Usage notes Combined with the **ip forward-protocol udp** command in global configuration mode, the **ip helper-address** command in interface mode allows control of which protocols (destination port numbers) are forwarded. The **ip forward-protocol udp** command configures protocols for forwarding, and the **ip helper-address** command configures the destination address(es).

The destination address can be a unicast address or a subnet broadcast address. The UDP destination port is configured separately with the **ip forward-protocol udp** command. If multiple destination addresses are registered then UDP packets are forwarded to each IP address added to an IP Helper. Up to 32 destination addresses may be added using IP Helper.

The device will only forward the types of UDP broadcast packets that are specified by the **ip forward-protocol** command(s). The device does not forward any other UDP packet types by default.

The **ip helper-address** command does not support BOOTP / DHCP Relay. The **service dhcp-relay** command must be used instead. For this reason, you may not configure UDP ports 67 and 68 with the **ip forward-protocol** command.

See the [IP Feature Overview and Configuration Guide](#) for more information about DHCP Relay.

Examples The following example defines IPv4 address 192.168.1.100 as an IP Helper destination address to which to forward UDP broadcasts received on eth1:

```
awplus# configure terminal
awplus(config)# interface eth1
awplus(config-if)# ip helper-address 192.168.1.100
```

The following example removes IPv4 address 192.168.1.100 as an IP Helper destination address to which to forward UDP broadcasts received on eth1:

```
awplus# configure terminal
awplus(config)# interface eth1
awplus(config-if)# no ip helper-address 192.168.1.100
```

Related commands

- [ip forward-protocol udp](#)
- [ip directed-broadcast](#)
- [show running-config](#)

ip icmp error-interval

Overview Use this command to limit how often IPv4 ICMP error messages are sent. The maximum frequency of messages is specified in milliseconds.

Use the **no** variant of this command to reset the frequency to the default.

Syntax `ip icmp error-interval <interval>`
`no ip icmp error-interval`

Parameter	Description
<code><interval></code>	0-2147483647, interval in milliseconds.

Default 1000

Mode Global Configuration

Example To configure the rate to be at most one packet every 10 seconds, use the commands:

```
awplus# configure terminal
awplus(config)# ip icmp error-interval 10000
```

To reset the rate to the default of one packet every second, use the commands:

```
awplus# configure terminal
awplus(config)# no ip icmp error-interval
```

Related commands [ipv6 icmp error-interval](#)

ip icmp-timestamp

Overview Use this command to allow ICMP timestamp request and response packets. Use the **no** variant of this command to drop ICMP timestamp request and response packets.

You may wish to drop these packets because the ICMP timestamp response contains the device's date and time. This information could theoretically be used against some systems to exploit weak time-based random number generators in other services. In addition, it may be possible to fingerprint devices by analyzing their responses to invalid ICMP timestamp requests.

Syntax `ip icmp-timestamp`
`no ip icmp-timestamp`

Default Allowed

Mode Global Configuration

Example To drop ICMP timestamp packets, use the commands:

```
awplus# configure terminal
awplus(config)# no ip icmp-timestamp
```

To allow ICMP timestamp packets again, use the commands:

```
awplus# configure terminal
awplus(config)# ip icmp-timestamp
```

Related commands [ip tcp-timestamp](#)

Command changes Version 5.5.2-0.1: command added

ip limited-local-proxy-arp

Overview Use this command to enable local proxy ARP, but only for a specified set of IP addresses. This makes the device respond to ARP requests for those IP addresses when the addresses are reachable via the interface you are configuring.

To specify the IP addresses, use the command [local-proxy-arp](#).

Use the **no** variant of this command to disable limited local proxy ARP. This stops your device from intercepting and responding to ARP requests for the specified hosts. This allows the hosts to use MAC address resolution to communicate directly with one another.

Syntax `ip limited-local-proxy-arp`
`no ip limited-local-proxy-arp`

Default Limited local proxy ARP is disabled by default.

Mode Interface Configuration for VLAN, Eth, WWAN, L2TP tunnel, Multipoint VPN GRE, and bridge interfaces and 802.1Q sub-interfaces.

Usage Limited local proxy ARP supports Static NAT configurations in which the NAT configuration's public address is different to the Ethernet interface's address.

On such Ethernet interfaces, the device needs to respond to ARP requests for the public address so that it will receive packets targeted at that address.

Limited local proxy ARP makes this possible. It is especially useful when you have a number of 1-1 NAT configurations and each public address falls within the public interface's subnet. If you enable limited local proxy ARP on the public interface and specify suitable addresses, the device will respond to ARP requests for those addresses, as long as the addresses are routed out the interface the ARP requests are received on. The device responds with its own MAC address.

Example The following configuration snippet shows how to use limited local proxy ARP, if you are using NAT for an HTTP server with an address of 172.22.0.3 connected via eth1, and eth1 has an address of 172.22.0.1:

```
! Create a private zone for the HTTP server with address 172.22.200.3:
zone private
network vlan1
ip subnet 172.22.200.0/24
host http_server
ip address 172.22.200.3
!
! Create a public zone for the HTTP server with address 172.22.0.3:
zone public
network eth1
ip subnet 0.0.0.0/0 interface eth1
host http_server
ip address 172.22.0.3
!
! Create a NAT rule to map from the public to the private zone:
nat
rule 10 portfwd http from public.eth1 to public.eth1.http_server with dst
private.vlan1.http_server
enable
!
! Configure eth1. It has a different public address than the HTTP server:
interface eth1
ip limited local-proxy-arp
ip address 172.22.0.1/24
!
! Configure vlan1:
interface vlan1
ip address 172.22.200.5/24
!
! Tell the device to respond to ARPs for the HTTP server public address:
local-proxy-arp 172.22.0.3/32
```

Related commands [ip local-proxy-arp](#)
[local-proxy-arp](#)

ip local-proxy-arp

Overview This command allows you to stop MAC address resolution between hosts within a subnet. Local Proxy ARP works by intercepting ARP requests between hosts within a subnet and responding with your device's own MAC address details instead of the destination host's details. This stops hosts from learning the MAC address of other hosts within its subnet through ARP requests.

Local Proxy ARP ensures that devices within a subnet cannot send traffic that bypasses Layer 3 routing on your device. This lets you monitor and filter traffic between hosts in the same subnet, and enables you to have control over which hosts may communicate with one another.

When Local Proxy ARP is operating on an interface, your device does not generate or forward any ICMP-Redirect messages on that interface. This command does not enable proxy ARP on the interface; see the [ip proxy-arp](#) command for more information on enabling proxy ARP.

The **no** variant of this command disables Local Proxy ARP to stop your device from intercepting and responding to ARP requests between hosts within a subnet. This allows the hosts to use MAC address resolution to communicate directly with one another. Local Proxy ARP is disabled by default.

Syntax `ip local-proxy-arp`
`no ip local-proxy-arp`

Default Local Proxy ARP is disabled by default.

Mode Interface Configuration for VLAN, Eth, WWAN, L2TP tunnel, Multipoint VPN GRE, and bridge interfaces and 802.1Q sub-interfaces.

Examples To enable your device to apply Local Proxy ARP on the interface `vlan2`, use the following commands:

```
awplus# configure terminal
awplus(config)# interface vlan2
awplus(config-if)# ip local-proxy-arp
```

To stop your device from doing Local Proxy ARP on the interface `vlan2`, use the following commands:

```
awplus# configure terminal
awplus(config)# interface vlan2
awplus(config-if)# no ip local-proxy-arp
```

Related commands [ip proxy-arp](#)
[show arp](#)
[show running-config](#)

ip proxy-arp

Overview This command enables Proxy ARP responses to ARP requests on an interface. When enabled, your device intercepts ARP broadcast packets and substitutes its own physical address for that of the remote host. By responding to the ARP request, your device ensures that subsequent packets from the local host are directed to its physical address, and it can then forward these to the remote host.

Your device responds only when it has a specific route to the address being requested, excluding the interface route that the ARP request arrived from. It ignores all other ARP requests. See the [ip local-proxy-arp](#) command about enabling your device to respond to other ARP messages.

The **no** variant of this command disables Proxy ARP responses on an interface. Proxy ARP is disabled by default.

Syntax `ip proxy-arp`
`no ip proxy-arp`

Default Proxy ARP is disabled by default.

Mode Interface Configuration for VLAN, Eth, WWAN, L2TP tunnel, Multipoint VPN GRE, and bridge interfaces and 802.1Q sub-interfaces.

Examples To enable your device to do Proxy ARP on the interface `vlan2`, use the following commands:

```
awplus# configure terminal
awplus(config)# interface vlan2
awplus(config-if)# ip proxy-arp
```

To stop your device from doing Proxy ARP on the interface `vlan2`, use the following commands:

```
awplus# configure terminal
awplus(config)# interface vlan2
awplus(config-if)# no ip proxy-arp
```

Related commands [arp](#)
[ip local-proxy-arp](#)
[show arp](#)
[show running-config](#)

ip redirects

Overview This command enables the device to send ICMP redirects.

Use the **no** variant of this command to stop the device from sending ICMP redirects.

Syntax `ip redirects`
`no ip redirects`

Default ICMP redirects are disabled by default.

Mode Global Configuration.

Usage notes ICMP redirect messages are used to notify hosts that a better route is available to a destination.

ICMP redirects are used when a packet is routed into the device on the same interface that the packet is routed out of the device. ICMP redirects are only sent to packet sources that are directly connected to the device.

Examples To enable the switch to send ICMP redirects, use the following commands:

```
awplus# configure terminal
awplus(config)# ip redirects
```

To stop the switch from sending ICMP redirects, use the following commands:

```
awplus# configure terminal
awplus(config)# no ip redirects
```

ip tcp synack-retries

Overview Use this command to specify how many times the switch will retry sending a SYN ACK for a TCP connection for which it has received a SYN but not an ACK. Such connections are called half-open TCP connections. This command allows you to influence how long half-open TCP connections take to time out.

Use the **no** variant of this command to return to the default setting of 5 retries.

Syntax `ip tcp synack-retries <0-255>`
`no ip tcp synack-retries`

Parameter	Description
<0-255>	Number of times to retry sending the SYN ACK

Default 5 retries

Mode Global Configuration

Usage notes The following table shows the approximate correlation between the number of retries and the time half-open TCP connections take to time out.

Number of retries	Approximate lower bound for the timeout
0 retries	1 second
1 retry	3 seconds
2 retries	7 seconds
3 retries	15 seconds
4 retries	31 seconds
5 retries	63 seconds

Example To retry twice, which leads to a timeout of approximately 7 seconds, use the commands:

```
awplus# configure terminal  
awplus(config)# ip tcp synack-retries 2
```

Related commands [show running-config](#)

Command changes Version 5.4.7-0.2: command added

ip tcp timeout established

Overview Use this command to set the idle timeout for all established TCP connections. Use the **no** variant of this command to set the idle timeout back to the default of 3600 seconds.

Syntax `ip tcp timeout established <1-31536000>`
`no ip tcp timeout established`

Parameter	Description
<code><1-31536000></code>	Idle timeout for established TCP connections in seconds from 1 to 3153600.

Default 3600 seconds (1 hour)

Mode Global Configuration

Usage notes By default, when a TCP session is successfully established through the firewall, when the session goes idle, it automatically times out of the firewall connection tracking table after 3600 seconds. In some situations it may be beneficial to time out unused established TCP sessions earlier.

For example, in a busy environment where there is an excessive number of sessions being established, the firewall connection tracking table could become oversubscribed, with new connections being blocked until older sessions are timed out.

Example To set a non-default TCP session timeout for established idle sessions of 1800 seconds (30 minutes), use the commands:

```
awplus# configure terminal
awplus(config)# ip tcp timeout established 1800
```

Example To set the TCP session timeout for established idle sessions back to the default setting of 3600 seconds, use the commands:

```
awplus# configure terminal
awplus(config)# no ip tcp timeout established
```

Related commands [show running-config](#)

Command changes Version 5.4.6-1.1: command added

ip tcp-timestamp

Overview Use this command to enable TCP timestamp responses.

Use the **no** variant of this command to disable TCP timestamp responses.

You may wish to disable timestamp responses because TCP timestamps may allow other parties to remotely calculate the system uptime and boot time of the device and the device's clock. To prevent this information leaking to potential attackers, we recommend you disable TCP timestamps on the device, unless you need to use them.

Syntax `ip tcp-timestamp`
`no ip tcp-timestamp`

Default Enabled

Mode Global Configuration

Example To disable TCP timestamp responses, use the commands:

```
awplus# configure terminal
awplus(config)# no ip tcp-timestamp
```

To enable TCP timestamp responses again, use the commands:

```
awplus# configure terminal
awplus(config)# ip tcp-timestamp
```

Related commands [ip icmp-timestamp](#)

Command changes Version 5.5.2-0.1: command added

ip unreachables

Overview Use this command to enable ICMP (Internet Control Message Protocol) type 3, destination unreachable, messages.

Use the **no** variant of this command to disable destination unreachable messages. This prevents an attacker from using these messages to discover the topology of a network.

Syntax `ip unreachables`
`no ip unreachables`

Default Destination unreachable messages are enabled by default.

Mode Global Configuration

Usage notes When a device receives a packet for a destination that is unreachable it returns an ICMP type 3 message, this message includes a reason code, as per the table below. An attacker can use these messages to obtain information regarding the topology of a network. Disabling destination unreachable messages, using the **no ip unreachables** command, secures your network against this type of probing.

NOTE: *Disabling ICMP destination unreachable messages breaks applications such as traceroute and Path MTU Discovery (PMTUD), which depend on these messages to operate correctly.*

Table 21-2: ICMP type 3 reason codes and description

Code	Description [RFC]
0	Network unreachable [RFC792]
1	Host unreachable [RFC792]
2	Protocol unreachable [RFC792]
3	Port unreachable [RFC792]
4	Fragmentation required, and DF flag set [RFC792]
5	Source route failed [RFC792]
6	Destination network unknown [RFC1122]
7	Destination host unknown [RFC1122]
8	Source host isolated [RFC1122]
9	Network administratively prohibited [RFC768]
10	Host administratively prohibited [RFC869]
11	Network unreachable for Type of Service [RFC908]
12	Host unreachable for Type of Service [RFC938]
13	Communication administratively prohibited [RFC905]

Table 21-2: ICMP type 3 reason codes and description (cont.)

Code	Description [RFC]
14	Host Precedence Violation [RFC1812]
15	Precedence cutoff in effect [RFC1812]

Example To disable destination unreachable messages, use the commands

```
awplus# configure terminal  
awplus(config)# no ip unreachable
```

To enable destination unreachable messages, use the commands

```
awplus# configure terminal  
awplus(config)# ip unreachable
```

local-proxy-arp

Overview Use this command to specify an IP subnet for use with limited local proxy ARP. When limited local proxy ARP is enabled with the command `ip limited-local-proxy-arp`, the device will respond to ARP requests for addresses in that subnet.

Use the **no** variant of this command to stop specifying a subnet for use with limited local proxy ARP.

Syntax `local-proxy-arp [<ip-add/mask>]`
`no local-proxy-arp [<ip-add/mask>]`

Parameter	Description
<code><ip-add/mask></code>	The IP subnet to use with limited local proxy ARP, in dotted decimal format (A.B.C.D/M). To specify a single IP address, use a 32-bit mask.

Default No subnets are specified for use with limited local proxy ARP.

Mode Global Configuration

Example To specify limited local proxy ARP for the address 172.22.0.3, use the following commands:

```
awplus# configure terminal
awplus(config)# local-proxy-arp 172.22.0.3/32
```

This is part of a configuration snippet that shows how to use limited local proxy ARP with static NAT. See the command `ip limited-local-proxy-arp` for the whole example.

Related commands `ip limited-local-proxy-arp`

optimistic-nd

Overview Use this command to enable the optimistic neighbor discovery feature for both IPv4 and IPv6.

Use the **no** variant of this command to disable the optimistic neighbor discovery feature.

Syntax `optimistic-nd`
`no optimistic-nd`

Default The optimistic neighbor discovery feature is enabled by default.

Mode Interface Configuration for a VLAN interface.

Usage notes The optimistic neighbor discovery feature allows the device, after learning an IPv4 or IPv6 neighbor, to refresh the neighbor before it is deleted from the ARP or neighbor tables. The optimistic neighbor discovery feature enables the device to sustain L3 traffic switching to a neighbor without interruption.

If a neighbor receiving optimistic neighbor solicitations does not answer optimistic neighbor solicitations with neighbor advertisements, then the device puts the neighbor entry into the 'stale' state, and subsequently deletes it from the L3 switching tables.

Examples To enable the optimistic neighbor discovery feature on vlan2, use the following commands:

```
awplus# configure terminal
awplus(config)# interface vlan2
awplus(config-if)# optimistic-nd
```

To disable the optimistic neighbor discovery feature on vlan2, use the following commands:

```
awplus# configure terminal
awplus(config)# interface vlan2
awplus(config-if)# no optimistic-nd
```

Related commands [show running-config](#)

ping

Overview This command sends a query to another IPv4 host (send Echo Request messages).

Syntax ping [ip] <host> [broadcast] [df-bit {yes|no}] [interval <0-128>] [pattern <hex-data-pattern>] [repeat {<1-2147483647>|continuous}] [size <36-18024>] [source <ip-addr>] [timeout <1-65535>] [tos <0-255>]

Syntax (VRF-lite) ping [vrf <vrf-name>] [ip] <host> [broadcast] [df-bit {yes|no}] [interval <0-128>] [pattern <hex-data-pattern>] [repeat {<1-2147483647>|continuous}] [size <36-18024>] [source <ip-addr>] [timeout <1-65535>] [tos <0-255>]

Parameter	Description
<host>	The destination IP address or hostname.
broadcast	Allow pinging of a broadcast address.
df-bit	Enable or disable the do-not-fragment bit in the IP header.
interval <0-128>	Specify the time interval in seconds between sending ping packets. The default is 1. You can use decimal places to specify fractions of a second. For example, to ping every millisecond, set the interval to 0.001.
pattern <hex-data-pattern>	Specify the hex data pattern.
repeat	Specify the number of ping packets to send.
<1-2147483647>	Specify repeat count. The default is 5.
continuous	Continuous ping
size <36-18024>	The number of data bytes to send, excluding the 8 byte ICMP header. The default is 56 (64 ICMP data bytes).
source <ip-addr>	The IP address of a configured IP interface to use as the source in the IP header of the ping packet.
timeout <1-65535>	The time in seconds to wait for echo replies if the ARP entry is present, before reporting that no reply was received. If no ARP entry is present, it does not wait.
tos <0-255>	The value of the type of service in the IP header.
vrf	Apply the command to the specified VRF instance.
<vrf-name>	The name of the VRF instance.

Mode User Exec and Privileged Exec

Example To ping the IP address 10.10.0.5 use the following command:

```
awplus# ping 10.10.0.5
```

Example (VRF-lite) To ping the IP address 10.10.0.5 from VRF instance 'red', use the following command:

```
awplus# ping vrf red 10.10.0.5
```

NOTE: *Unless a cross-domain static or leaked route exists to the destination IP address, you must run this command from within the same routing domain as the address being pinged.*

Command changes Version 5.4.6-2.1: VRF-lite support added.

show arp

Overview Use this command to display entries in the ARP routing and forwarding table—the ARP cache contains mappings of IP addresses to physical addresses for hosts. To have a dynamic entry in the ARP cache, a host must have used the ARP protocol to access another host.

For information on filtering and saving command output, see the [“Getting Started with AlliedWare Plus” Feature Overview and Configuration Guide](#).

Syntax show arp

Syntax (VRF-lite) show arp [global|vrf <vrf-name>]

Parameter	Description
global	When VRF-lite is configured, apply this command to the global routing and forwarding table
vrf	Apply this command to the specified VRF instance.
<vrf-name>	The VRF instance name

Mode User Exec and Privileged Exec

Usage notes Running this command with no additional parameters will display all entries in the ARP routing and forwarding table.

With VRF-lite configured, and no additional parameters entered, the command output displays all entries, listed by their VRF instance. By adding either a specific VRF instance or global parameter entry, you can selectively list ARP entries by their membership of a specific VRF instance.

Example To display all ARP entries in the ARP cache, use the following command:

```
awplus# show arp
```

Output Figure 21-3: Example output from the **show arp** command

```
awplus#show arp
IP Address      LL Address      Interface  Port           Type
192.168.27.10   192.168.4.1     vlan1      port1.0.1      dynamic
192.168.27.100 0000.daaf.cd24  vlan1      port1.0.2      dynamic
...
```

Example (VRF-lite) To display the dynamic ARP entries in the global routing instance, use the command:

```
awplus# show arp global
```

Output Figure 21-4: Example output from the **show arp global** command

```
awplus#show arp global
IP Address      LL Address      Interface      Port           Type
192.168.10.2    0015.77ad.fad8 vlan1          port1.0.1     dynamic
192.168.20.2    0015.77ad.fa48 vlan2          port1.0.2     dynamic
192.168.1.100  00d0.6b04.2a42 vlan2          port1.0.3     static
```

Example (VRF-lite) To display the dynamic ARP entries for a VRF instance 'red', use the command:

```
awplus# show arp vrf red
```

Output Figure 21-5: Example output from the **show arp vrf red** command

```
awplus# show arp vrf red
[VRF: red]
IP Address      LL Address      Interface      Port           Type
192.168.10.2    0015.77ad.fad8 vlan1          port1.0.1     dynamic
```

Table 22: Parameters in the output of the **show arp** command

Parameter	Meaning
IP Address	IP address of the network device this entry maps to.
LL Address	Hardware address of the network device.
Interface	Interface over which the network device is accessed.
Port	Physical port that the network device is attached to.
Type	Whether the entry is a static or dynamic entry. Static entries are added using the arp command. Dynamic entries are learned from ARP request/reply message exchanges.
VRF	The name of the VRF instance. The VRF-lite components only display when VRF-lite is configured.

Related commands

- [arp](#)
- [clear arp-cache](#)
- [ip vrf](#)

Command changes

- Version 5.4.6-2.1: VRF-lite support added.
- Version 5.4.9-0.1: Link layer addresses now shown as the hardware address (MAC Address output parameter has been renamed to LL Address).

show debugging ip packet

Overview Use this command to see what debugging is turned on for IP interfaces. IP interface debugging is set using the **debug ip packet interface** command.

For information on filtering and saving command output, see the [“Getting Started with AlliedWare Plus” Feature Overview and Configuration Guide](#).

Syntax show debugging ip packet

Mode User Exec and Privileged Exec

Example To display the IP interface debugging status when the terminal monitor is off, use the commands:

```
awplus# terminal no monitor
awplus# show debugging ip packet
```

Output Figure 21-6: Example output from the **show debugging ip packet** command with **terminal monitor** off

```
awplus#terminal no monitor
awplus#show debugging ip packet
IP debugging status:
interface all tcp (stopped)
...
```

Example To display the IP interface debugging status when the terminal monitor is on, use the commands:

```
awplus# terminal monitor
awplus# show debugging ip packet
```

Output Figure 21-7: Example output from the **show debugging ip packet** command with **terminal monitor** on

```
awplus#terminal monitor
awplus#show debugging ip packet
IP debugging status:
interface all tcp (running)
...
```

Related commands [debug ip packet interface](#)
[terminal monitor](#)

show ip flooding-nextops

Overview Use this command to display the static and dynamic ARP entries in the ARP cache that flood packets to multiple ports.

When VRF-lite is configured, you can apply this command to a specific VRF instance.

Syntax `show ip flooding-nextops`

Syntax (VRF-lite) `show ip flooding-nextops [vrf <vrf-name>|global]`

Parameter	Description
<code>vrf <vrf-name></code>	VRF instance
<code>global</code>	Global Routing/Forwarding table

Mode User Exec and Privileged Exec

Usage notes To display the flooding nexthop entries associated with a VRF instance, use the **show ip flooding-nextops vrf** command in User Exec and Privileged Exec mode.

To display the entries in the global ARP table only, use the **show ip flooding-nextop global** command.

Example To display all of the flooding nexthop entries in the ARP cache, use the command:

```
awplus# show ip flooding-nextops
```

Output Figure 21-8: Example output from **show ip flooding-nextops**

```
awplus#show ip flooding-nextops
IP Address      MAC Address      Interface      Flooding Mode      Type
11.11.11.10     0300.0000.0011  vlan1         port-group         static
[VRF: test]
IP Address      MAC Address      Interface      Flooding Mode      Type
10.10.10.10     0100.0000.0000  vlan2         port-group         static
```

Related commands [show arp](#)

Command changes Version 5.4.8-2.1: command added

show ip forwarding

Overview Use this command to display the IP forwarding status.

Syntax `show ip forwarding`

Mode User Exec and Privileged Exec

Example `awplus# show ip forwarding`

Output Figure 21-9: Example output from the **show ip forwarding** command

```
awplus#show ip forwarding
IP forwarding is on
```

Related commands [ip forwarding](#)

show ip interface

Overview Use this command to display information about interfaces and the IP addresses assigned to them. To display information about a specific interface, specify the interface name with the command.

For information on filtering and saving command output, see the [“Getting Started with AlliedWare Plus” Feature Overview and Configuration Guide](#).

Syntax `show ip interface [<interface-list>] [brief]`

Parameter	Description
<code><interface-list></code>	The interfaces to display information about. An interface-list can be: <ul style="list-style-type: none">• a PPP interface (e.g. ppp0)• an Eth interface (e.g. eth1)• an 802.1Q Ethernet sub-interface (e.g. eth1.10, where '10' is the VLAN ID specified by the encapsulation dot1q command)• a VLAN (e.g. vlan2)• a bridge interface (e.g. br0)• a tunnel interface (e.g. tunnel0)• a WWAN interface (e.g. wwan0)• the loopback interface (lo)• a continuous range of interfaces, separated by a hyphen (e.g. ppp2-4)• a comma-separated list (e.g. ppp0,ppp2-4). Do not mix interface types in a list. The specified interfaces must exist.

Mode User Exec and Privileged Exec

Examples To show the IP addresses assigned to ppp0, use the command:

```
awplus# show ip interface ppp0 brief
```

Output Figure 21-10: Example output from the **show ip interface brief** command

Interface	IP-Address	Status	Protocol
port1.0.1	unassigned	admin up	down
...			
vlan1	192.168.1.1	admin up	running
...			

show ip interface vrf

Overview Use this command to display protocol and status information about configured interfaces and their assigned IP addresses in VRF instances.

For information on filtering and saving command output, see the [“Getting Started with AlliedWare Plus” Feature Overview and Configuration Guide](#).

Syntax `show ip interface [vrf <vrf-name>|global]`

Parameter	Description
vrf	A VRF instance.
<vrf-name>	The name of a specific VRF instance.
global	The global routing and forwarding table.

Mode User Exec and Privileged Exec

Examples To display all interfaces and IP addresses associated with a VRF instance ‘red’, use the command:

```
awplus# show ip interface vrf red
```

Output Figure 21-11: Example output from **show ip interface vrf red**

[VRF: red]			
Interface	IP-Address	Status	Protocol
lo1	unassigned	admin up	running
vlan1	192.168.10.1/24	admin up	running

Example To display all interfaces and IP addresses associated with all VRF instances, use the command:

```
awplus# show ip interface
```

Output Figure 21-12: Example output from the **show ip interface** with VRF-lite configured

Interface	IP-Address	Status	Protocol
eth0	unassigned	admin up	down
lo	unassigned	admin up	running
vlan1	192.168.1.1/24	admin up	running
vlan4	172.30.4.43/24	admin up	down
[VRF: red]			
Interface	IP-Address	Status	Protocol
lo1	unassigned	admin up	running
[VRF: blue]			
Interface	IP-Address	Status	Protocol
lo2	unassigned	admin up	running

Command changes Version 5.4.6-2.1: VRF-lite support added.

show ip sockets

Overview Use this command to display information about the IP or TCP sockets that are present on the device. It includes TCP and UDP listen sockets, and displays the associated IP address and port.

The information displayed for established TCP sessions includes the remote IP address, port, and session state. Raw IP protocol listen socket information is also displayed for protocols such as VRRP and ICMP6, which are configured to receive IP packets with the associated protocol number.

For information on filtering and saving command output, see the [“Getting Started with AlliedWare Plus” Feature Overview and Configuration Guide](#).

Syntax `show ip sockets`

Mode Privileged Exec

Usage notes Use this command to verify that the socket being used is opening correctly. If there is a local and remote endpoint, a connection is established with the ports indicated.

Note that this command does not display sockets that are used internally for exchanging data between the various processes that exist on the device and are involved in its operation and management. It only displays sockets that are present for the purposes of communicating with other external devices.

Example To display IP sockets currently present on the device, use the command:

```
awplus# show ip sockets
```

Output Figure 21-13: Example output from **show ip sockets**

```
Socket information

Not showing 40 local connections
Not showing 7 local listening ports
```

Typ	Local Address	Remote Address	State
tcp	0.0.0.0:111	0.0.0.0:*	LISTEN
tcp	0.0.0.0:80	0.0.0.0:*	LISTEN
tcp	0.0.0.0:23	0.0.0.0:*	LISTEN
tcp	0.0.0.0:443	0.0.0.0:*	LISTEN
tcp	0.0.0.0:4743	0.0.0.0:*	LISTEN
tcp	0.0.0.0:873	0.0.0.0:*	LISTEN
tcp	:::23	:::*	LISTEN
udp	0.0.0.0:111	0.0.0.0:*	
udp	226.94.1.1:5405	0.0.0.0:*	
udp	0.0.0.0:161	0.0.0.0:*	
udp	:::161	:::*	
raw	0.0.0.0:112	0.0.0.0:*	112
raw	:::58	:::*	58
raw	:::112	:::*	112

Table 21-1: Parameters in the output from **show ip sockets**

Parameter	Description
Not showing <number> local connections	This field refers to established sessions between processes internal to the device, that are used in its operation and management. These sessions are not displayed as they are not useful to the user. <number> is some positive integer.
Not showing <number> local listening ports	This field refers to listening sockets belonging to processes internal to the device, that are used in its operation and management. They are not available to receive data from other devices. These sessions are not displayed as they are not useful to the user. <number> is some positive integer.
Typ	This column displays the type of the socket. Possible values for this column are: tcp : IP Protocol 6 udp : IP Protocol 17 raw : Indicates that socket is for a non port-orientated protocol (i.e. a protocol other than TCP or UDP) where all packets of a specified IP protocol type are accepted. For raw socket entries the protocol type is indicated in subsequent columns.
Local Address	For TCP and UDP listening sockets this shows the destination IP address and destination TCP or UDP port number for which the socket will receive packets. The address and port are separated by ':'. If the socket will accept packets addressed to any of the device's IP addresses, the IP address will be 0.0.0.0 for IPv4 or :: for IPv6. For active TCP sessions the IP address will display which of the devices addresses the session was established with. For raw sockets this displays the IP address and IP protocol for which the socket will accept IP packets. The address and protocol are separated by ':'. If the socket will accept packets addressed to any of the device's IP addresses, the IP address will be 0.0.0.0 for IPv4 and :: for IPv6. IP Protocol assignments are described at: www.iana.org/assignments/protocol-numbers

Table 21-1: Parameters in the output from **show ip sockets** (cont.)

Parameter	Description
Remote Address	For TCP and UDP listening sockets this shows the source IP address (either IPv4 or IPv6) and source TCP or UDP port number for which the socket will accept packets. The address and port are separated by ':'. If the socket will accept packets addressed from any IP address, the IP address will be 0.0.0.0 for IPv4 . This is the usual case for a listening socket. Normally for a listen socket any source port will be accepted. This is indicated by '. For active TCP sessions the IP address will display the remote address and port the session was established with. For raw sockets the entry in this column will be 0.0.0.0: for IPv4 .
State	This column shows the state of the socket. For TCP sockets this shows the state of the TCP state machine. For UDP sockets this column is blank. For raw sockets it contains the IP protocol number. The possible TCP states are: LISTEN SYN-SENT SYN-RECEIVED ESTABLISHED FIN-WAIT-1 FIN-WAIT-2 CLOSE-WAIT CLOSING LAST-ACK TIME-WAIT CLOSED RFC793 contains the TCP state machine diagram with Section 3.2 describing each of the states.

show ip traffic

Overview Use this command to display statistics regarding IP traffic sent and received by all interfaces on the device, showing totals for IP and IPv6 and then broken down into sub-categories such as TCP, UDP, ICMP and their IPv6 equivalents when appropriate.

For information on filtering and saving command output, see the [“Getting Started with AlliedWare Plus” Feature Overview and Configuration Guide](#).

Syntax show ip traffic

Mode Privileged Exec

Example To display IP traffic statistics, use the command:

```
awplus# show ip traffic
```

Output Figure 21-14: Example output from the **show ip traffic** command

```
awplus#show ip traffic
IP:
    168475 packets received
    168475 delivered
    208099 sent
    35 dropped due to missing route
    22646409 bytes received
    126783216 bytes sent
    InCsumErrors 0
    InNoECTPkts 168475
    InECT1Pkts 0
    InECT0Pkts 0
    InCEPkts 0
    In107 Destination Unreachable
    Out11 Destination Unreachable
IPv6:
    14 packets received
    14 received packets delivered
    18 packets transmitted
...
ICMP6:
    4 messages sent
...
UDP6:
    Udp6RcvbufErrors 0
...
UDPLite6:
    UdpLite6RcvbufErrors 0
...
```

```
TCP:
    8 remote connections established
...
UDP:
    79797 datagrams received
...
UDPLite:
    InCsumErrors 0
...
```

tcpdump

Overview Use this command to start a tcpdump, which gives the same output as the Unix-like **tcpdump** command to display TCP/IP traffic. Press <ctrl> + c to stop a running tcpdump.

Syntax tcpdump <line>

Syntax (VRF-lite) tcpdump [vrf <vrf-name>] <line>

Parameter	Description
<line>	Specify the dump options. For more information on the options for this placeholder see http://www.tcpdump.org/tcpdump_man.html
vrf	Apply the command to the specified VRF instance.
<vrf-name>	The name of the VRF instance.

Mode Privileged Exec

Example To start a tcpdump running to capture IP packets, enter the command:

```
awplus# tcpdump ip
```

Example (VRF-lite) To start a tcpdump on interface vlan2 associated with a VRF instance red, enter the command:

```
awplus# tcpdump vrf red vlan2
```

Output Figure 21-15: Example output from the **tcpdump** command

```
03:40:33.221337 IP 192.168.1.1 > 224.0.0.13: PIMv2, Hello,
length: 34
1 packets captured
2 packets received by filter
0 packets dropped by kernel
```

Related commands [debug ip packet interface](#)

Command changes Version 5.4.6-2.1: VRF-lite support added.

traceroute

Overview Use this command to trace the route to the specified IPv4 host.

Syntax `traceroute {<ip-addr>|<hostname>}`

Syntax (VRF-lite) `traceroute [vrf <vrf-name>] {<ip-addr>|<hostname>}`

Parameter	Description
<code><ip-addr></code>	The destination IPv4 address. The IPv4 address uses the format A.B.C.D.
<code><hostname></code>	The destination hostname.
<code>vrf</code>	Apply the command to the specified VRF instance.
<code><vrf-name></code>	The name of the VRF instance.

Mode User Exec and Privileged Exec

Example `awplus# traceroute 10.10.0.5`

Example (VRF-lite) `awplus# traceroute vrf red 192.168.0.1`

Command changes Version 5.4.6-2.1: VRF-lite support added.

undebug ip packet interface

Overview This command applies the functionality of the no `debug ip packet interface` command.

22

Domain Name Service (DNS) Commands

Introduction

Overview This chapter provides an alphabetical reference of commands used to configure Domain Name Service (DNS) features, including the following:

- DNS client
- DNS forwarding (DNS relay)
- Domain lists
- DDNS (Dynamic Domain Name System)

For more information about DNS and DDNS for AR-Series Firewalls, see the [Domain Name System \(DNS\) for AlliedWare Plus AR-Series Firewalls Feature Overview and Configuration Guide](#).

- Command List**
- `"accept-invalid-sslcert"` on page 805
 - `"clear ip dns forwarding cache"` on page 806
 - `"custom-failure"` on page 807
 - `"custom-success"` on page 808
 - `"ddns enable"` on page 809
 - `"ddns-update-method"` on page 810
 - `"ddns-update now"` on page 812
 - `"debug ddns"` on page 813
 - `"debug ip dns forwarding"` on page 814
 - `"description (domain-list)"` on page 815
 - `"domain"` on page 816
 - `"expect-html-response"` on page 817
 - `"follow-redirects"` on page 818
 - `"get-before-submit"` on page 819

- [“get-params”](#) on page 820
- [“host-name \(ddns-update-method\)”](#) on page 821
- [“ip ddns-update-method”](#) on page 822
- [“ip dns forwarding”](#) on page 823
- [“ip dns forwarding cache”](#) on page 824
- [“ip dns forwarding dead-time”](#) on page 826
- [“ip dns forwarding domain-list”](#) on page 827
- [“ip dns forwarding retry”](#) on page 828
- [“ip dns forwarding source-interface”](#) on page 829
- [“ip dns forwarding timeout”](#) on page 830
- [“ip domain-list”](#) on page 831
- [“ip domain-lookup”](#) on page 832
- [“ip domain-name”](#) on page 834
- [“ip name-server”](#) on page 835
- [“ip name-server preferred-order”](#) on page 837
- [“ipv6 ddns-update-method”](#) on page 838
- [“obey-form”](#) on page 839
- [“password \(ddns-update-method\)”](#) on page 840
- [“ppp ipcp dns”](#) on page 841
- [“ppp ipcp dns suffix-list”](#) on page 843
- [“retry-interval”](#) on page 845
- [“show ddns-update-method status”](#) on page 846
- [“show debugging ip dns forwarding”](#) on page 847
- [“show hosts”](#) on page 848
- [“show ip dns forwarding”](#) on page 849
- [“show ip dns forwarding cache”](#) on page 850
- [“show ip dns forwarding server”](#) on page 852
- [“show ip domain-list”](#) on page 854
- [“show ip domain-name”](#) on page 855
- [“show ip name-server”](#) on page 856
- [“suppress-ipv4-updates”](#) on page 858
- [“undebg ddns”](#) on page 859
- [“update-interval \(ddns-update-method\)”](#) on page 860
- [“update-url \(ddns-update-method\)”](#) on page 861
- [“use-ipv4-for-ipv6-updates”](#) on page 864

- [“username \(ddns-update-method\)”](#) on page 865

accept-invalid-sslcert

Overview Use this command to tell the dynamic DNS client to connect to an HTTPS server even if the server is producing an invalid SSL certificate (because it is self-signed, for a different host, expired, etc.).

Use the **no** variant of this command to return to the default.

Syntax `accept-invalid-sslcert`
`no accept-invalid-sslcert`

Default Not set

Mode Dynamic DNS Update Method Configuration

Example If the HTTPS server you are using for the dynamic DNS configuration "test" does not have a valid SSL certificate, then use the following commands:

```
awplus# configure terminal
awplus(config)# ddns-update-method test
awplus(config-ddns-update-method)# accept-invalid-sslcert
```

Command changes Version 5.5.0-0.1: command added

clear ip dns forwarding cache

Overview Use this command to clear the DNS Relay name resolver cache.

When using VRF-lite, use this command to clear the DNS Relay name resolver cache for either the whole device or for a specific VRF instance.

Syntax `clear ip dns forwarding cache`

Syntax (VRF-lite) `clear ip dns [vrf <name>|global] forwarding cache`

Parameter	Description
vrf	Apply this command to the specified VRF instance.
<name>	The name of the specific VRF instance
global	When VRF-lite is configured, apply this command to the global routing and forwarding table.

Mode Privileged Exec

Examples To clear all cached data, use the command:

```
awplus# clear ip dns forwarding cache
```

Example (VRF-lite) To clear the cached data for VRF instance red, use the command:

```
awplus# clear ip dns vrf red forwarding cache
```

To clear the cached data for the default global VRF instance only, use the command:

```
awplus# clear ip dns global forwarding cache
```

Related commands [ip dns forwarding cache](#)

Command changes Version 5.4.6-2.1: VRF-lite support added.

custom-failure

Overview Use this command to specify the update server's failure message for Dynamic DNS. You only need to do this if the failure message is different to the ones in DDNS's built-in list.

Use the **no** variant of this command to remove the customized failure message.

Syntax `custom-failure <failure-word>`
`no custom-failure`

Parameter	Description
<code><failure-word></code>	A word that the update server sends to indicate a failed update.

Default No customized failure message

Mode Dynamic DNS Update Method Configuration

Example If the update server sends a message of 'AllBad' to indicate a failed update, use the commands:

```
awplus# configure terminal
awplus(config)# ddns-update-method test
awplus(config-ddns-update-method)# custom-failure AllBad
```

Related commands [custom-success](#)
[ddns-update-method](#)
[show ddns-update-method status](#)

Command changes Version 5.5.1-1.1: command added

custom-success

Overview Use this command to specify the update server's success message for Dynamic DNS. You only need to do this if the success message is different to the ones in DDNS's built-in list.

Use the **no** variant of this command to remove the customized success message.

Syntax `custom-success <success-word>`
`no custom-success`

Parameter	Description
<code><success-word></code>	A word that the update server sends to indicate a successful update.

Default No customized success message

Mode Dynamic DNS Update Method Configuration

Example If the update server sends a message of 'AllGood' to indicate a successful update, use the commands:

```
awplus# configure terminal
awplus(config)# ddns-update-method test
awplus(config-ddns-update-method)# custom-success AllGood
```

Related commands [custom-failure](#)
[ddns-update-method](#)
[show ddns-update-method status](#)

Command changes Version 5.5.1-1.1: command added

ddns enable

Overview Use this command to globally enable or disable DDNS updates. DDNS updates are disabled by default. DDNS configuration will remain when the updates are disabled and DDNS will still be configurable when updates are disabled.

Use the **no** variant of this command to disable DDNS updates.

Syntax `ddns enable`
`no ddns enable`

Default Disabled

Mode Global Configuration

Example To globally enable DDNS updates, use the commands:

```
awplus# configure terminal
awplus(config)# ddns enable
```

To globally disable DDNS updates, use the commands:

```
awplus# configure terminal
awplus(config)# no ddns enable
```

Related commands [ddns-update-method](#)

Command changes Version 5.4.7-0.1: command added

ddns-update-method

Overview Use this command to create a new DDNS update method and enter DDNS Update Method Configuration mode.

Use the **no** variant of this command to remove a DDNS update method.

Syntax `ddns-update-method <method-name>`
`no ddns-update-method <method-name>`

Parameter	Description
<code><method-name></code>	The name of the DDNS method.

Default None

Mode Global Configuration

Example To create a method named "dyndns", use the commands:

```
awplus# configure terminal
awplus(config)# ddns-update-method dyndns
awplus(config-ddns-update-method)#
```

Related commands

- custom-failure
- custom-success
- ddns enable
- ddns-update now
- debug ddns
- expect-html-response
- host-name (ddns-update-method)
- ip ddns-update-method
- ipv6 ddns-update-method
- password (ddns-update-method)
- retry-interval
- show ddns-update-method status
- suppress-ipv4-updates
- update-interval (ddns-update-method)
- update-url (ddns-update-method)
- use-ipv4-for-ipv6-updates
- username (ddns-update-method)

Command changes Version 5.4.7-0.1: command added

ddns-update now

Overview Use this command to manually update DDNS methods.

Syntax `ddns-update now`
`ddns-update method <method-name> now`

Parameter	Description
<code><method-name></code>	The DDNS update method name to use for the manual update.

Default None

Mode Privileged Exec

Usage notes When no method name is entered, all DDNS update methods are updated. If a method name is specified, then only that method will update.

Example To manually update all DDNS update methods, use the command:

```
awplus# ddns-update now
```

To manually update the method "dyndns", use the command:

```
awplus# ddns-update method dyndns now
```

Related commands [ddns-update-method](#)

Command changes Version 5.4.7-0.1: command added

debug ddns

Overview Use this command to enable debugging for the DDNS process.
Use the **no** variant of this command to disable debugging for the DDNS process.

Syntax debug ddns
no debug ddns

Default Disabled

Mode Privileged Exec

Example To enable debugging for the DDNS process, use the command:

```
awplus# debug ddns
```

To disable debugging for the DDNS process, use the command:

```
awplus# no debug ddns
```

Related commands [ddns-update-method](#)
[undebug ddns](#)

Command changes Version 5.4.7-0.1: command added

debug ip dns forwarding

Overview Use this command to enable DNS Relay debugging.
Use the **no** variant of this command to disable DNS Relay debugging.

Syntax `debug ip dns forwarding`
`no debug ip dns forwarding`

Default DNS Relay debugging is disabled by default.

Mode Privileged Exec

Examples To enable DNS forwarding debugging, use the commands:

```
awplus# debug ip dns forwarding
```

To disable DNS forwarding debugging, use the commands:

```
awplus# no debug ip dns forwarding
```

Related commands [ip dns forwarding](#)
[show debugging ip dns forwarding](#)

description (domain-list)

Overview Use this command to give a description to a domain-list.
Use the **no** variant of this command to delete the description.

Syntax `description <text>`
`no description`

Parameter	Description
<code><text></code>	Description string, 128 characters maximum. The string may contain spaces.

Mode Domain List

Usage notes When creating a domain-list, it is helpful to write a short description of what the list is to be used for.

Examples To add a description to a domain list, use the commands:

```
awplus# configure terminal
awplus(config)# ip dns forwarding domain-list mydomains
awplus(config-domain-list)# description This is a useful
description of my domain list
```

To delete the description, use the commands:

```
awplus# configure terminal
awplus(config)# ip dns forwarding domain-list mydomains
awplus(config-domain-list)# no description
```

Related commands [ip dns forwarding domain-list](#)

domain

Overview Use this command to add a domain to a domain list.
Use the **no** variant of this command to delete the domain.

Syntax `domain <domain-string>`
`no domain <domain-string>`

Parameter	Description
<code><domain-string></code>	<ul style="list-style-type: none">• A domain name must only contain a-z, A-Z, 0-9, '-' (en-dash) and '.' (period) characters.• Each sub-section of the domain must not start or end with the '-' character.• Each sub-section must have no more than 64 characters including the '.'.• The last section must not have a '.' at the end.• The whole domain must be less than 254 characters long.

Mode Domain List

Usage notes Domain lists are objects that contain unsorted lists of domain names. After a domain list has been created, you can use this command to add domains to the domain list. There is no limit on the number of domains that can be added to a domain list.

Examples To add the domain "acme-solutions.com" to a domain list, use the commands:

```
awplus# configure terminal
awplus(config)# ip dns forwarding domain-list acme-corporation
awplus(config-domain-list)# domain acme-solutions.com
```

To delete the domain, use the commands:

```
awplus# configure terminal
awplus(config)# ip dns forwarding domain-list acme-corporation
awplus(config-domain-list)# no domain acme-solutions.com
```

Related commands [ip dns forwarding domain-list](#)

expect-html-response

Overview Use this command to allow Dynamic DNS to accept HTML formatted responses from the update server (and reject non-HTML responses). You need this if the update server sends HTML responses instead of plain text responses.

Use the **no** variant of this command to stop Dynamic DNS from accepting HTML responses.

Syntax `expect-html-response`
`no expect-html-response`

Default Disabled (HTML responses are rejected)

Mode Dynamic DNS Update Method Configuration

Example To configure DDNS to only accept an HTML response, use the commands:

```
awplus# configure terminal
awplus(config)# ddns-update-method test
awplus(config-ddns-update-method)# expect-html-response
```

Related commands [ddns-update-method](#)
[show ddns-update-method status](#)

Command changes Version 5.5.1-1.1: command added

follow-redirects

Overview Use this command to accept redirects during the initial GET request and during the update. See the command **get-before-submit**. The behavior without this command is to treat redirects as a failure.

Use the **no** variant of this command to disable following redirects.

Syntax follow-redirects
no follow-redirects

Default disabled

Mode Dynamic DNS Update Method Configuration

Example To configure DDNS to accept redirects, use the commands:

```
awplus# configure terminal
awplus(config)# ddns-update-method dyndns
awplus(config-ddns-update-method)# follow-redirects
```

Related commands [ddns-update-method](#)
[get-before-submit](#)
[obey-form](#)

Command changes Version 5.5.1-0.1: command added

get-before-submit

Overview Use this command to make DDNS perform a GET request for the page without any parameters before making the DDNS update submission.

Use the **no** variant of this command to disable this process.

Syntax `get-before-submit`
`no get-before-submit`

Default Disabled

Mode Dynamic DNS Update Method Configuration

Usage notes This command may be required if the service you are using either:

- follows a series of redirects before accepting the update submission (see the command **follow-redirects**).
- or
- if the update submission is normally submitted by the browser and contains either a CSRF token or Session ID (see the command **get-params**).

NOTE: *Cookies from this GET request are used during the update submission.*

Example To configure DDNS to perform a GET request for the page without any parameters before making the DDNS update submission, use the commands:

```
awplus# configure terminal
awplus(config)# ddns-update-method dyndns
awplus(config-ddns-update-method)# get-before-submit
```

Related commands [ddns-update-method](#)
[follow-redirects](#)
[get-params](#)
[obey-form](#)

Command changes Version 5.5.1-0.1: command added

get-params

Overview Use this command to support update services that use CSRF and other session tracking. This command picks up the required input fields and adds them to the request when it is sent.

Use the **no** variant of this command to remove parameters.

Syntax `get-params <parameter-name>`
`no get-params`

Parameter	Description
<code><parameter-name></code>	A comma separated list of input fields to include the values in the update.

Default No parameters are set

Mode Dynamic DNS Update Method Configuration

Usage notes During the **get-before-submit** stage, the HTML of the page is interpreted, and any input fields that match any of the names in the list are included as extra parameters when the update is submitted.

Example To configure the support update services that use CSRF, use the commands:

```
awplus# configure terminal
awplus(config)# ddns-update-method dyndns
awplus(config-ddns-update-method)# get-before-submit
awplus(config-ddns-update-method)# get-params session,csrf
```

Related commands [ddns-update-method](#)
[get-before-submit](#)

Command changes Version 5.5.1-0.1: command added

host-name (ddns-update-method)

Overview Use this command to add a host name for the current DDNS update method.

NOTE: A DDNS update method can only have one host name.

Use the **no** variant of this command to remove the host name from the current DDNS update method.

Syntax host-name <host-name>
no host-name

Parameter	Description
<host-name>	The name of the host to be configured in conjunction with the user name and password.

Default None

Mode Dynamic DNS Update Method Configuration

Example To add the host name "test.dyndns.org" for the DDNS update method "dyndns", use the commands:

```
awplus# configure terminal
awplus(config)# ddns-update-method dyndns
awplus(config-ddns-update-method)# host-name test.dyndns.org
```

To remove the host name "test.dyndns.org" from the DDNS update method "dyndns", use the commands:

```
awplus# configure terminal
awplus(config)# ddns-update-method dyndns
awplus(config-ddns-update-method)# no host-name
```

Related commands [ddns-update-method](#)

Command changes Version 5.4.7-0.1: command added

ip ddns-update-method

Overview Use this command to enable an IPv4 interface to update DDNS with the specified DDNS update method.

Use the **no** variant of this command to disable an IPv4 interface to update DDNS with the specified DDNS update method.

Syntax `ip ddns-update-method <method-name>`
`no ip ddns-update-method <method-name>`

Parameter	Description
<code><method-name></code>	A name given to a DDNS update method.

Default None

Mode Interface Configuration

Usage notes A DDNS update method cannot be attached to multiple interfaces, however multiple DDNS update methods can be assigned to the same interface.

Example To enable IPv4 DDNS updates for a DDNS update method named “dyndns” using interface eth1, use the commands:

```
awplus# configure terminal
awplus(config)# interface eth1
awplus(config-if)# ip ddns-update-method dyndns
```

To disable IPv4 DDNS updates for a DDNS update method named “dyndns” using interface eth1, use the commands:

```
awplus# configure terminal
awplus(config)# interface eth1
awplus(config-if)# no ip ddns-update-method dyndns
```

Related commands [ddns-update-method](#)

Command changes Version 5.4.7-0.1: command added

ip dns forwarding

Overview Use this command to enable DNS Relay, the forwarding of incoming DNS queries for IP hostname-to-address translation.

Use the **no** variant of this command to disable the forwarding of incoming DNS queries for IP hostname-to-address translation.

Syntax `ip dns forwarding`
`no ip dns forwarding`

Default The forwarding of incoming DNS query packets is disabled by default.

Mode Global Configuration

Usage notes DNS Relay is independent of the configuration of [ip domain-lookup](#) (which is enabled by default). If [ip domain-lookup](#) is disabled, but DNS Relay is enabled, the router will continue to forward DNS queries by hosts in the network to its configured name-servers.

See the [ip dns forwarding dead-time](#) command used with this command.

NOTE: *When running VRF-lite, the DNS Relay functions will apply separately within each VRF instance.*

Examples To enable the forwarding of incoming DNS query packets, use the commands:

```
awplus# configure terminal
awplus(config)# ip dns forwarding
```

To disable the forwarding of incoming DNS query packets, use the commands:

```
awplus# configure terminal
awplus(config)# no ip dns forwarding
```

Related commands

- [clear ip dns forwarding cache](#)
- [debug ip dns forwarding](#)
- [ip dns forwarding cache](#)
- [ip dns forwarding dead-time](#)
- [ip dns forwarding retry](#)
- [ip dns forwarding source-interface](#)
- [ip dns forwarding timeout](#)
- [ip domain-lookup](#)
- [ip name-server](#)
- [show ip dns forwarding](#)
- [show ip dns forwarding cache](#)
- [show ip dns forwarding server](#)

ip dns forwarding cache

Overview Use this command to set the DNS Relay name resolver cache size and cache entry lifetime period. The DNS Relay name resolver cache stores the mappings between domain names and IP addresses.

Use the **no** variant of this command to set the default DNS Relay name resolver cache size and cache entry lifetime period.

Note that the lifetime period of the cache entry can be overwritten by the time-out period of the DNS reply from the DNS server if the time-out period of the DNS reply from the DNS server is smaller than the configured time-out period. The time-out period of the cache entry will only be used when the time-out period of the DNS reply from the DNS server is bigger than the time-out period configured on the device.

Syntax `ip dns forwarding cache [size <0-10000>] [timeout <60-3600>]`
`no ip dns forwarding cache [size|timeout]`

Parameter	Description
<0-10000>	Number of entries in the DNS Relay name resolver cache.
<60-3600>	Timeout value in seconds. Note that when running VRF-lite the number of entries configured will apply to each VRF instance.

Default The default cache size is 0 (no entries) and the default lifetime is 1800 seconds.

Mode Global Configuration

Examples To set the cache size to 10 entries and the lifetime to 500 seconds, use the commands:

```
awplus# configure terminal
awplus(config)# ip dns forwarding cache size 10 time 500
```

To set the cache size to the default, use the commands:

```
awplus# configure terminal
awplus(config)# no ip dns forwarding cache size
```

Related commands

- [clear ip dns forwarding cache](#)
- [debug ip dns forwarding](#)
- [ip dns forwarding](#)
- [show ip dns forwarding](#)
- [show ip dns forwarding cache](#)

Command changes Version 5.4.8-1.1: maximum cache limit increased to 10000

ip dns forwarding dead-time

Overview Use this command to set the time period in seconds when the device stops sending any DNS requests to an unresponsive server and all retries set using [ip dns forwarding retry](#) are used. This time period is the DNS forwarding dead-time. The device stops sending DNS requests at the DNS forwarding dead-time configured and when all of the retries are used.

Use the **no** variant of this command to restore the default DNS forwarding dead-time value of 3600 seconds.

Syntax `ip dns forwarding dead-time <60-43200>`
`no ip dns forwarding retry`

Default The default time to stop sending DNS requests to an unresponsive server is 3600 seconds.

Mode Global Configuration

Usage notes See the [ip dns forwarding retry](#) command used with this command.

Examples To set the DNS forwarding retry count to 50 and to set the DNS forwarding dead-time to 1800 seconds, use the commands:

```
awplus# configure terminal
awplus(config)# ip dns forwarding dead-time 1800
awplus(config)# ip dns forwarding retry 50
```

To reset the DNS retry count to the default of 2 and the DNS forwarding dead-time to the default of 3600, use the commands:

```
awplus# configure terminal
awplus(config)# no ip dns forwarding dead-time
awplus(config)# no ip dns forwarding retry
```

Related commands

- [debug ip dns forwarding](#)
- [ip dns forwarding](#)
- [ip dns forwarding retry](#)
- [show ip dns forwarding](#)
- [show ip dns forwarding server](#)

ip dns forwarding domain-list

Overview Use this command to create a domain-list that can be used as a suffix-list for DNS lookups. This command puts the device into a new mode where subsequent commands can be entered. The new mode is "Domain List Configuration" mode.

Use the **no** variant of this command to delete the domain-list.

Syntax `ip dns forwarding domain-list <domain-list-name>`
`no ip dns forwarding domain-list <domain-list-name>`

Parameter	Description
<code><domain-list-name></code>	Name of the list.

Mode Global Configuration

Usage notes The domain list can be used by features that need to match against domains. A domain list by itself does nothing; it must be attached to another feature to have functionality (like a prefix-list). For example, the domain list can be used as a suffix list on an DNS name-server. The DNS server can be either statically configured, or learned over a PPP connection.

Note that this command is separate from the **ip domain-list** command, which is used by DNS client to append a domain on to the end of a partial hostname to form a fully-qualified domain.

Examples To create a domain list to include domains that are internal to the company such as "engineering.acme" or "intranet.acme", use the commands:

```
awplus# configure terminal
awplus(config)# ip dns forwarding domain-list corporatedomains
awplus(config-domain-list)# description internal network domain
awplus(config-domain-list)# domain engineering.acme
awplus(config-domain-list)# domain intranet.acme
```

To delete the domain list, use the commands:

```
awplus# configure terminal
awplus(config)# no ip dns forwarding domain-list
corporatedomains
```

Related commands [description \(domain-list\)](#)
[domain](#)

ip dns forwarding retry

Overview Use this command to set the number of times DNS Relay will retry to forward DNS queries. The device stops sending DNS requests to an unresponsive server at the time set using the [ip dns forwarding dead-time](#) command and when all of the retries are used.

Use the **no** variant of this command to set the number of retries to the default of 2.

Syntax `ip dns forwarding retry <0-100>`
`no ip dns forwarding retry`

Default The default number of retries is 2 DNS requests to an unresponsive server.

Mode Global Configuration

Usage notes See the [ip dns forwarding dead-time](#) command used with this command.

Examples To set the DNS forwarding retry count to 50 and to set the DNS forwarding dead-time to 1800 seconds, use the commands:

```
awplus# configure terminal
awplus(config)# ip dns forwarding retry 50
awplus(config)# ip dns forwarding dead-time 1800
```

To reset the DNS retry count to the default of 2 and the DNS forwarding dead-time to the default of 3600 seconds, use the commands:

```
awplus# configure terminal
awplus(config)# no ip dns forwarding retry
awplus(config)# no ip dns forwarding dead-time
```

Related commands

- [debug ip dns forwarding](#)
- [ip dns forwarding](#)
- [ip dns forwarding dead-time](#)
- [show ip dns forwarding](#)

ip dns forwarding source-interface

Overview Use this command to set the interface to use for forwarding and receiving DNS queries.

Use the **no** variant of this command to unset the interface used for forwarding and receiving DNS queries.

Syntax `ip dns forwarding source-interface <interface-name>`
`no ip dns forwarding source-interface`

Parameter	Description
<code><interface-name></code>	An alphanumeric string that is the interface name.

Default The default is that no interface is set and the device selects the appropriate source IP address automatically.

Mode Global Configuration

Examples To set eth1.2 as the source interface for relayed DNS queries, use the commands:

```
awplus# configure terminal  
awplus(config)# ip dns forwarding source-interface eth1.2
```

To clear the source interface for relayed DNS queries, use the commands:

```
awplus# configure terminal  
awplus(config)# no ip dns forwarding source-interface
```

Related commands [debug ip dns forwarding](#)
[ip dns forwarding](#)
[show ip dns forwarding](#)

ip dns forwarding timeout

Overview Use this command to set the time period for the DNS Relay to wait for a DNS response.

Use the **no** variant of this command to set the time period to wait for a DNS response to the default of 3 seconds.

Syntax `ip dns forwarding timeout <0-3600>`
`no ip dns forwarding timeout`

Default The default timeout value is 3 seconds.

Mode Global Configuration

Examples To set the timeout value to 12 seconds, use the commands:

```
awplus# configure terminal
awplus(config)# ip dns forwarding timeout 12
```

To set the timeout value to the default of 3 seconds, use the commands:

```
awplus# configure terminal
awplus(config)# no ip dns forwarding timeout
```

Related commands [debug ip dns forwarding](#)
[ip dns forwarding](#)
[show ip dns forwarding](#)

ip domain-list

Overview This command adds a domain to the DNS list. Domains are appended to incomplete host names in DNS requests. Each domain in this list is tried in turn in DNS lookups. This list is ordered so that the first entry you create is checked first.

The **no** variant of this command deletes a domain from the list.

Syntax `ip domain-list <domain-name>`
`no ip domain-list <domain-name>`

Parameter	Description
<code><domain-name></code>	Domain string, for example "company.com".

Mode Global Configuration

Usage notes If there are no domains in the DNS list, then your device uses the domain specified with the `ip domain-name` command. If any domain exists in the DNS list, then the device does not use the domain set using the `ip domain-name` command.

Example To add the domain `example.net` to the DNS list, use the following commands:

```
awplus# configure terminal
awplus(config)# ip domain-list example.net
```

Related commands `ip domain-lookup`
`ip domain-name`
`show ip domain-list`

ip domain-lookup

Overview This command enables the DNS client on your device. This allows you to use domain names instead of IP addresses in commands. The DNS client resolves the domain name into an IP address by sending a DNS inquiry to a DNS server, specified with the `ip name-server` command.

It is possible to configure the DNS client to use the DNS relay to resolve domain lookups originating from the device itself. This configuration may be preferred, as the DNS relay provides additional functionality that is not available in the DNS client, such as caching, a configurable timeout length, and other options.

The **no** variant of this command disables the DNS client. The client will not attempt to resolve domain names. You must use IP addresses to specify hosts in commands.

Syntax `ip domain-lookup [via-relay]`
`no ip domain-lookup`

Parameter	Description
<code>via-relay</code>	Perform resolution via DNS relay

Mode Global Configuration

Usage notes The client is enabled by default. However, it does not attempt DNS inquiries unless there is a DNS server configured.

Examples To enable the DNS client on your device, use the following commands:

```
awplus# configure terminal
awplus(config)# ip domain-lookup
```

To configure the DNS client to perform resolution via the DNS relay, use the following commands:

```
awplus# configure terminal
awplus(config)# ip domain-lookup via-relay
awplus(config)# ip dns forwarding
```

To disable the DNS client on your device, use the following commands:

```
awplus# configure terminal
awplus(config)# no ip domain-lookup
```

Related commands

- ip domain-list
- ip domain-name
- ip name-server
- show hosts
- show ip name-server

Command changes Version 5.4.8-1.1: via-relay parameter added

ip domain-name

Overview This command sets a default domain for the DNS. The DNS client appends this domain to incomplete host-names in DNS requests.

The **no** variant of this command removes the domain-name previously set by this command.

Syntax `ip domain-name <domain-name>`
`no ip domain-name <domain-name>`

Mode Global Configuration

Usage notes If there are no domains in the DNS list (created using the [ip domain-list](#) command) then your device uses the domain specified with this command. If any domain exists in the DNS list, then the device does not use the domain configured with this command.

When your device is using its DHCP client for an interface, it can receive Option 15 from the DHCP server. This option replaces the domain name set with this command.

Example To configure the domain name, enter the following commands:

```
awplus# configure terminal
awplus(config)# ip domain-name company.com
```

Related commands [ip domain-list](#)
[show ip domain-list](#)
[show ip domain-name](#)

ip name-server

Overview Use this command to add IPv4 or IPv6 DNS server addresses. The DNS client on your device sends DNS queries to IP addresses in this list when trying to resolve a host name. Host names cannot be resolved until you have added at least one server to this list. A maximum of three name servers can be added to this list.

If you are running VRF-lite, you can add IPv4 or IPv6 DNS server addresses for either the global VRF instance or for a specific VRF instance. Host names cannot be resolved from within a VRF instance until you have added at least one name-server to that VRF instance.

The **no** variant of this command removes the specified DNS name-server address.

Syntax `ip name-server <ip-addr> [suffix-list <domain-list>]`
`no ip name-server <ip-addr> [suffix-list]`

Syntax (VRF-lite) `ip name-server [vrf <name>] <ip-addr>`
`no ip name-server [vrf <name>] <ip-addr>`

Parameter	Description
<code><ip-addr></code>	The IP address of the DNS server that is being added to the name server list. The address is entered in the form A.B.C.D for an IPv4 address, or in the form X:X::X:X for an IPv6 address. The order that you enter the servers in, is the order in which they will be used.
<code>vrf</code>	Apply this command to the specified VRF instance.
<code><name></code>	The name of the specific VRF instance
<code>suffix-list</code>	Specify domain suffixes that should be directed to this name server
<code><domain-list></code>	The name of the DNS domain-list

Mode Global Configuration

Usage notes To allow the device to operate as a DNS proxy, your device must have learned about a DNS name-server to forward requests to. Name-servers can be learned through the following means:

- Manual configuration, using the **ip name-server** command
- Learned from DHCP server with Option 6
- Learned over a PPP tunnel if the neighbor advertises the DNS server

Use this command to statically configure a DNS name-server for the device to use.

The order that you enter the servers in, is the order in which they will be used.

For more information about PPP and DNS, see the [PPP Feature Overview and Configuration Guide](#).

Examples To allow a device to send DNS queries to a DNS server with the IPv4 address 10.10.10.5, use the commands:

```
awplus# configure terminal
awplus(config)# ip name-server 10.10.10.5
```

To enable your device to send DNS queries to a DNS server with the IPv6 address 2001:0db8:010d::1, use the commands:

```
awplus# configure terminal
awplus(config)# ip name-server 2001:0db8:010d::1
```

For DNS relay, to direct DNS lookups for domains with suffixes of "engineering.acme" or "intranet.acme" to an internal corporate name-server, use the commands:

```
awplus# configure terminal
awplus(config)# ip dns forwarding domain-list corporatedomains
awplus(config-domain-list)# description Our internal network
domains; do not send DNS requests to internet
awplus(config-domain-list)# domain engineering.acme
awplus(config-domain-list)# domain intranet.acme
awplus(config-domain-list)# exit
awplus(config)# ip name-server 172.16.0.1 suffix-list
corporatedomains
```

Example (VRF-lite) To enable your switch to send DNS queries (on VRF instance RED) to a DNS server with the IPv4 address 10.10.10.5 use the commands:

```
awplus# configure terminal
awplus(config)# ip name-server vrf RED 10.10.10.5
```

Related commands

- [ip domain-list](#)
- [ip domain-lookup](#)
- [ip domain-name](#)
- [show ip dns forwarding cache](#)
- [show ip name-server](#)

Command changes Version 5.4.6-2.1: VRF-lite support added to AR-series devices.

ip name-server preferred-order

Overview Use this command to choose between using statically-configured DNS servers or dynamically-learned DNS servers.

Use the **no** variant of this command to set the DNS servers back to the default setting of dynamic.

Syntax `ip name-server preferred-order {dynamic|static}`
`no ip name-server preferred-order`

Parameter	Description
dynamic	Use dynamically learned DNS servers first.
static	Use statically configured DNS servers first.

Default dynamic

Mode Global Configuration

Usage notes This command is used to choose which DNS server set to use first. Select either the **dynamic** or **static** parameter.

Examples To configure the preference to use static servers first, use the commands:

```
awplus# configure terminal  
awplus(config)# ip name-server preferred-order static
```

To configure the preference to use dynamically-learned servers first, use the commands:

```
awplus# configure terminal  
awplus(config)# ip name-server preferred-order dynamic
```

or

```
awplus# configure terminal  
awplus(config)# no ip name-server preferred-order
```

Related commands [ip address dhcp](#)
[ip name-server](#)
[ipv6 address dhcp](#)
[ppp ipcp dns](#)
[show ip name-server](#)

Command changes Version 5.4.9-0.1: command added

ipv6 ddns-update-method

Overview Use this command to enable an IPv6 interface to update DDNS with the specified DDNS update method.

Use the **no** variant of this command to disable an IPv6 interface to update DDNS with the specified DDNS update method.

Syntax `ipv6 ddns-update-method <method-name>`
`no ipv6 ddns-update-method <method-name>`

Parameter	Description
<code><method-name></code>	A name given to a DDNS update method.

Default None

Mode Interface Configuration

Usage notes A DDNS update method cannot be attached to multiple interfaces, however multiple DDNS update methods can be assigned to the same interface.

Example To enable IPv6 DDNS updates for a DDNS update method named "dyndns" using interface eth1, use the following commands:

```
awplus# configure terminal
awplus(config)# interface eth1
awplus(config-if)# ipv6 ddns-update-method dyndns
```

To disable IPv6 DDNS updates for a DDNS update method named "dyndns" using interface eth1, use the following commands:

```
awplus# configure terminal
awplus(config)# interface eth1
awplus(config-if)# no ipv6 ddns-update-method dyndns
```

Related commands [ddns-update-method](#)

Command changes Version 5.4.7-0.1: command added

obey-form

Overview Use this command to read the action URL from the form and submit to that URL instead of the current page's URL. This is needed for forms that don't submit to the current page's URL.

Use the **no** variant of this command to disable form submission.

Syntax obey-form
no obey-form

Default Disabled

Mode Dynamic DNS Update Method Configuration

Usage notes This command applies after the **follow-redirects** and **get-before-submit** commands are applied.

Example To turn on obey-form, use the commands:

```
awplus# configure terminal
awplus(config)# ddns-update-method dyndns
awplus(config-ddns-update-method)# get-before-submit
awplus(config-ddns-update-method)# obey-form
```

Related commands [ddns-update-method](#)
[get-before-submit](#)
[follow-redirects](#)

Command changes Version 5.5.0.1: command added

password (ddns-update-method)

Overview Use this command to add a password to the current DDNS update method.
Use the **no** variant of this command to remove a password from the current DDNS update method.

Syntax password <password>
no password

Parameter	Description
<password>	The password to be configured in conjunction with the user name and host name.

Default None

Mode Dynamic DNS Update Method Configuration

Example To configure the password "test" for the method "dyndns", use the following commands:

```
awplus# configure terminal
awplus(config)# ddns-update-method dyndns
awplus(config-ddns-update-method)# password test
```

To remove the password "test" from the method "dyndns", use the following commands:

```
awplus# configure terminal
awplus(config)# ddns-update-method dyndns
awplus(config-ddns-update-method)# no password
```

Related commands [ddns-update-method](#)

Command changes Version 5.4.7-0.1: command added

ppp ipcp dns

Overview Use this command to configure the primary and secondary DNS (Domain Name System) IP addresses for IPCP (Internet Protocol Control Protocol) on a given PPP interface.

Use the **no** variant of this command to remove the primary and secondary DNS IP addresses for IPCP on a given PPP interface, and remove any optional parameters configured for DNS.

Syntax `ppp ipcp dns [<primary> [<secondary>]] [required|reject|request]`
`no ppp ipcp dns`

Parameter	Description
<code><primary></code>	Specify the primary DNS address for a given PPP interface to the peer.
<code><secondary></code>	Specify the secondary DNS address for a given PPP interface to the peer.
<code>required</code>	Request DNS addresses from the peer, and close the link if none is given.
<code>reject</code>	Reject negotiations with the peer (default).
<code>request</code>	Request DNS addresses from the peer.

Default By default no IPCP DNS server request is sent to the peer.

Mode Interface Configuration

Usage notes Use the optional parameters to configure PPP IPCP DNS options for accepting, rejecting or requesting DNS addresses from the peer. Use the optional primary and secondary or primary only DNS server address placeholders to specify DNS server addresses to the peer.

The no variant of this command also stops IPCP DNS request messages being sent to the peer.

Examples To configure the PPP interface `ppp0` to require a DNS IP address from the peer, and close the link if a DNS IP address is not given, enter the below commands:

```
awplus# configure terminal
awplus(config)# interface ppp0
awplus(config-if)# ppp ipcp dns required
```

To configure the PPP interface `ppp0` to require a DNS IP address from the peer, enter the below commands:

```
awplus# configure terminal
awplus(config)# interface ppp0
awplus(config-if)# ppp ipcp dns request
```

To configure the PPP interface `ppp0` to reject a DNS IP address from the peer, enter the below commands:

```
awplus# configure terminal
awplus(config)# interface ppp0
awplus(config-if)# ppp ipcp dns reject
```

To configure the PPP interface `ppp0` to supply primary and secondary DNS server addresses to the peer, enter the below commands:

```
awplus# configure terminal
awplus(config)# interface ppp0
awplus(config-if)# ppp ipcp dns 10.1.1.2 10.1.1.3
```

To configure the PPP interface `ppp0` to supply a primary but not a secondary DNS server address to the peer, enter the below commands:

```
awplus# configure terminal
awplus(config)# interface ppp0
awplus(config-if)# ppp ipcp dns 10.1.1.2
```

**Related
commands**

[ip address negotiated](#)
[peer default ip address](#)
[peer neighbor-route](#)
[show running-config interface](#)

ppp ipcp dns suffix-list

Overview Use this command to configure a suffix-list to be associated with DNS name-servers learned over the PPP connection.

Use the **no** variant of this command to remove the suffix-list.

Syntax `ppp ipcp dns suffix-list <domain-list-name>`
`no ppp ipcp dns suffix-list`

Parameter	Description
<code><domain-list-name></code>	The name of the DNS domain-list

Mode Interface Configuration

Usage notes A PPP connection can be configured to learn DNS servers from the remote peer by using the command `ppp ipcp dns` command.

This command allows a user to associate a domain-list to be used to match against the suffixes of incoming DNS requests. For example, a customer branch office may have a router that is used to give remote-access to their head office, over which they learn the IP address of the head office's DNS server. A domain list can be created that contains a suffix used for services internal to that company, for example, "example.lc". This domain-list is associated as a suffix-list to the PPP connection. So when the PPP connection is completed with the head office, users at the branch office that browse to "intranet.example.lc" will have the DNS request forwarded to the DNS server learned over the PPP connection. Without having the suffix-list configured, the DNS request for "intranet.example.lc" would instead be sent to the primary DNS server, which is likely to be the branch office's ISP, and they will simply respond with a negative reply, because .example.lc is not a globally routable domain.

Examples At a branch office, to direct DNS lookups for domains with suffixes of "engineering.acme" or "intranet.acme" to an internal corporate name-server run at head-office that was learned over a PPP connection, use the commands:

```
awplus# configure terminal
awplus(config)# ip dns forwarding domain-list corporatedomains
host(config-domain-list)# description Our internal network
domains; do not send DNS requests to internet
host(config-domain-list)# domain engineering.acme
host(config-domain-list)# domain intranet.acme
awplus(config)# interface ppp0
awplus(config-if)# ppp ipcp dns required
awplus(config-if)# ppp ipcp dns suffix-list corporatedomains
```

Related commands [ip dns forwarding domain-list](#)
[ppp ipcp dns](#)

retry-interval

Overview Use this command to enable DDNS update retries. Retries are attempted after a DDNS update fails after the specified interval. If the DDNS update keeps failing, then no more than the specified maximum retries are attempted.

NOTE: *The retry interval is used for one DDNS update at one time, so if an update is not complete within the specified interval, an update will not begin until it has completed.*

Use the **no** variant of this command to disable DDNS update retries.

Syntax `retry-interval <1-3888000> maximum-retries <1-100>`
`no retry-interval`

Parameter	Description
<1-3888000>	The retry interval in seconds (from 1 second to 4.5 days), after which a failed DDNS update will be retried.
<1-100>	The maximum number of times a retry is allowed.

Default Disabled

Mode Dynamic DNS Update Method Configuration

Usage notes If an update is triggered by another source, such as an IP address change or a manual update, then the retry counter will start again from the beginning.

Example To enable DDNS update retry attempts every hour up to 5 times for the method "dyndns", use the commands:

```
awplus# configure terminal
awplus(config)# ddns-update-method dyndns
awplus(config-ddns-update-method)# retry-interval 3600
maximum-retries 5
```

To disable DDNS update retry attempts for the method "dyndns", use the commands:

```
awplus# configure terminal
awplus(config)# ddns-update-method dyndns
awplus(config-ddns-update-method)# no retry-interval
```

Related commands [ddns-update-method](#)

Command changes Version 5.4.7-0.1: command added

show ddns-update-method status

Overview Use this command to show the status of the configured DDNS update methods.

Syntax show ddns-update-method status

Mode User Exec and Privileged Exec

Example To display the status of DDNS update methods currently configured on your device, use the command:

```
awplus# show ddns-update-method status
```

Output Figure 22-1: Example output from **show ddns-update-method status**

```
awplus#show ddns-update-method status

Dynamic DNS updates are enabled

-----
Update Method Name      test
Hostname                 test.dnsalias.org
IPv4 Interface          eth1
IPv4 Address            192.168.10.100
IPv4 Status              Update succeeded
IPv4 Update Result      good 192.168.10.100
IPv6 Interface          eth1
IPv6 Address            333::f195
IPv6 Status              Update succeeded
IPv6 Update Result      good 0333:0000:0000:0000:0000:0000:f195
Last update              Last update Mar 25, 2022 06:54:24
```

Related commands [ddns-update-method](#)

Command changes Version 5.4.7-0.1: command added

show debugging ip dns forwarding

Overview Use this command to see what debugging is turned on for DNS Relay. DNS Relay debugging is set using the **debug ip dns forwarding** command.

For information on filtering and saving command output, see the [“Getting_Started with AlliedWare Plus” Feature Overview and Configuration_Guide](#).

Syntax `show debugging ip dns forwarding`

Mode User Exec and Privileged Exec

Example To display the DNS Relay debugging status, use the command:

```
awplus# show debugging ip dns forwarding
```

Output Figure 22-2: Example output from the **show debugging ip dns forwarding** command:

```
awplus#show debugging ip dns forwarding

DNS Relay debugging status:
debugging is on
```

Related commands [debug ip dns forwarding](#)

show hosts

Overview This command shows the default domain, domain list, and name servers configured on your device.

For information on filtering and saving command output, see the [“Getting Started with AlliedWare Plus” Feature Overview and Configuration Guide](#).

Syntax `show hosts`

Mode User Exec and Privileged Exec

Example To display the default domain, use the command:

```
awplus# show hosts
```

Output Figure 22-3: Example output from the **show hosts** command when **no ip domain-lookup** is configured

```
awplus#show hosts

Default domain is not set
Name/address lookup is disabled
```

Figure 22-4: Example output from the **show hosts** command when **ip domain-lookup** is configured

```
awplus#show hosts

Default domain is mycompany.com
Domain list: company.com
Name/address lookup uses domain service
Name servers are 10.10.0.2 10.10.0.88
```

Figure 22-5: Example output from the **show hosts** command when **ip domain-lookup via-relay** is configured

```
awplus#show hosts

Default domain is mycompany.com
Domain list: company.com
Name/address lookup uses domain relay service
Name servers are 10.10.0.2 10.10.0.88
```

Related commands

- [ip domain-list](#)
- [ip domain-lookup](#)
- [ip domain-name](#)
- [ip name-server](#)

show ip dns forwarding

Overview Use this command to display the DNS Relay status.

Syntax show ip dns forwarding

Mode User Exec and Privileged Exec

Examples To display the DNS Relay status, use the command:

```
awplus# show ip dns forwarding
```

Output Figure 22-6: Example output from the **show ip dns forwarding** command

```
awplus#show ip dns forwarding

Max-Retry      : 2
Timeout        : 3 second(s)
Dead-Time      : 3600 second(s)
Source-Interface: not specified
DNS Cache      : disabled
```

Related commands [ip dns forwarding](#)

show ip dns forwarding cache

Overview Use this command to display the DNS Relay name resolver cache.

Syntax show ip dns forwarding cache

Syntax (VRF-lite) show ip dns [vrf <name>|global] forwarding cache

Parameter	Description
vrf	Apply this command to the specified VRF instance.
<name>	The name of the specific VRF instance
global	When VRF-lite is configured, apply this command to the global routing and forwarding table.

Mode User Exec and Privileged Exec

Example To display the DNS Relay name resolver cache, use the command:

```
awplus# show ip dns forwarding cache
```

Output Figure 22-7: Example output from the **show ip dns forwarding cache** command

```
awplus#show ip dns forwarding cache
IPv4 addresses in cache:    3
IPv6 addresses in cache:    0
Cache size: 1000
Host                        Address                Expires  Flags
www.example.com            172.16.1.1.            180
mail.example.com           www.example.com        180 CNAME
www.example.com            172.16.1.1.            180 REVERSE
mail.example.com           172.16.1.5.            180
```

Example (VRF-lite) To display the DNS Relay name resolver cache with output for VRF instance RED, use the command:

```
awplus# show ip dns vrf RED forwarding cache
```

Output Figure 22-8: Example output from the **show ip dns forwarding cache** command that includes output for VRF instance RED.

```
awplus#show ip dns vrf RED forwarding cache
IPv4 addresses in cache:    3
IPv6 addresses in cache:    0
Cache size: 1000
Host                        Address                    Expires  Flags
www.example.com            172.16.1.1.                180
mail.example.com          www.example.com            180 CNAME
www.example.com            172.16.1.1.                180 REVERSE
mail.example.com          172.16.1.5.                180

[VRF: RED]
www.example2.com          10.25.1.1.                 180
mail.example2.com        www.example2.com            180 CNAME
www.example2.com          10.25.1.1.                 180 REVERSE
mail.example2.com        10.25.1.6.                 180
```

Related commands [ip dns forwarding cache](#)
[ip name-server](#)

Command changes Version 5.4.6-2.1: VRF-lite support added.
Version 5.4.8-1.1: additional cache counters added to output.

show ip dns forwarding server

Overview Use this command to display the status of DNS forwarding name servers.

If you are running VRF, you can also use this command to display the status for DNS forwarding name servers operating on a specific VRF instance.

Syntax `show ip dns forwarding server`

Syntax (VRF-lite) `show ip dns [vrf <name>|global] forwarding server`

Parameter	Description
vrf	Apply this command to the specified VRF instance.
<name>	The name of the specific VRF instance
global	When VRF-lite is configured, apply this command to the global routing and forwarding table.
forwarding server	Display information about the DNS forwarding name servers for either the switch (when not using VRF-lite) or for a specific VRF instance (when using VRF-lite).

Mode User Exec and Privileged Exec

Examples To display the status of DNS Relay name servers, use the command:

```
awplus# show ip dns forwarding server
```

Output Figure 22-9: Example output from the **show ip dns forwarding server** command

```
awplus#show ip dns forwarding server

Servers          Forwards    Fails      Dead-Time
172.16.1.1       12          0          active
172.16.1.2       6           3          3900
```

Example (VRF-lite) To display the status of DNS Relay name-servers for VRF-lite instance red, use the command:

```
awplus# show ip dns vrf red forwarding server
```

Output Figure 22-10: Example output from the **show ip dns forwarding server** command

```
awplus#show ip dns forwarding server

[VRF: red]
Servers          Forwards    Fails      Dead-Time
172.16.1.1       12          0          active
172.16.1.2       6           3          3900
```

Related commands [ip dns forwarding](#)
[ip dns forwarding dead-time](#)

Command changes Version 5.4.6-2.1: VRF-lite support added.

show ip domain-list

Overview This command shows the domains configured in the domain list. The DNS client uses the domains in this list to append incomplete hostnames when sending a DNS inquiry to a DNS server.

For information on filtering and saving command output, see the [“Getting Started with AlliedWare Plus” Feature Overview and Configuration Guide](#).

Syntax `show ip domain-list`

Mode User Exec and Privileged Exec

Example To display the list of domains in the domain list, use the command:

```
awplus# show ip domain-list
```

Output Figure 22-11: Example output from the **show ip domain-list** command

```
awplus#show ip domain-list
alliedtelesis.com
mycompany.com
```

Related commands [ip domain-list](#)
[ip domain-lookup](#)

show ip domain-name

Overview This command shows the default domain configured on your device. When there are no entries in the DNS list, the DNS client appends this domain to incomplete hostnames when sending a DNS inquiry to a DNS server.

For information on filtering and saving command output, see the [“Getting Started with AlliedWare Plus” Feature Overview and Configuration Guide](#).

Syntax `show ip domain-name`

Mode User Exec and Privileged Exec

Example To display the default domain configured on your device, use the command:

```
awplus# show ip domain-name
```

Output Figure 22-12: Example output from the **show ip domain-name** command

```
awplus#show ip domain-name
alliedtelesis.com
```

Related commands [ip domain-name](#)
[ip domain-lookup](#)

show ip name-server

Overview This command displays a list of IPv4 and IPv6 DNS server addresses that your device will send DNS requests to. This is a static list configured using the `ip name-server` command.

The command will also show any domain-list that has been associated as suffix-list with the DNS server, and the domains that will be preferentially directed to that DNS server.

When running VRF-lite, this command displays a list of IPv4 and IPv6 addresses of DNS servers that your device will send DNS requests to for either the global VRF instance or a selected VRF instance.

For information on filtering and saving command output, see the [“Getting Started with AlliedWare Plus” Feature Overview and Configuration Guide](#).

Syntax `show ip name-server`

Syntax (VRF-lite) `show ip name-server [vrf <name>|global]`

Parameter	Description
vrf	A VRF instance
<name>	The name of the specific VRF instance
global	The global VRF instance

Mode User Exec and Privileged Exec

Example To display the list of DNS servers that your device sends DNS requests to, use the command:

```
awplus# show ip name-server
```

Output Figure 22-13: Example output from the `show ip name-server` command

```
awplus# show ip name-server
10.10.0.123
10.10.0.124
2001:0db8:010d::1
```

Example To display the list of DNS servers that your device sends DNS requests to, use the command:

```
awplus# show ip name-server
```

Output Figure 22-14: Example output from the **show ip name-server** command

```
awplus#show ip name-server
Currently learned name-servers
10.36.200.165 dynamic (ppp0)
10.35.12.20 dynamic (ppp1), using suffix-list mysuffixlist:
    test.com
    intranet.interslice.com
10.37.84.97 static
130.37.84.97 static
```

Output (VRF-lite) Figure 22-15: Example output from the **show ip name-server** command for the VRF instance "red"

```
awplus# show ip name-server vrf red

[VRF: red]
10.10.0.123
10.10.0.124
2001:0db8:010d::1
```

Related commands [ip domain-lookup](#)
[ip name-server](#)

Command changes Version 5.4.6-2.1: VRF-lite support added.

suppress-ipv4-updates

Overview Use this command to suppress IPv4 updates from being sent.

Use the **no** variant of this command to stop suppressing IPv4 updates from being sent.

Syntax `suppress-ipv4-updates`
`no suppress-ipv4-updates`

Default Disabled

Mode Dynamic DNS Update Method Configuration

Usage notes This command is used in conjunction with the **use-ipv4-for-ipv6-updates** command. IPv4 DDNS updates are suppressed so that only IPv6 updates are sent.

NOTE: *The IPv4 DNS entry may be updated using the source IPv4 address used.*

Example To suppress IPv4 updates and send IPv6 updates instead for the method "dyndns", use the commands:

```
awplus# configure terminal
awplus(config)# ddns-update-method-dyndns
awplus(config-ddns-update-method)# use-ipv4-for-ipv6-updates
awplus(config-ddns-update-method)# suppress-ipv4-updates
```

Related commands [ddns-update-method](#)
[use-ipv4-for-ipv6-updates](#)

Command changes Version 5.4.7-0.1: command added

undebug ddns

Overview Use this command to disable debugging for the DDNS process.

Syntax undebug ddns

Default Disabled

Mode Privileged Exec

Example To disable debugging for the DDNS process, use the command:

```
awplus# undebug ddns
```

Related commands [ddns-update-method](#)
[debug ddns](#)

Command changes Version 5.4.7-0.1: command added

update-interval (ddns-update-method)

Overview Use this command to specify the time interval between periodic DDNS updates. Use the **no** variant of this command to disable periodic DDNS updates.

Syntax `update-interval <1-64800>`
`no update-interval`

Parameter	Description
<code><1-64800></code>	Update interval time in minutes (from 1 minute to 45 days).

Default Disabled

Mode Dynamic DNS Update Method Configuration

Examples To enable periodic DDNS updates every day for the method "dyndns", use the commands:

```
awplus# configure terminal
awplus(config)# ddns-update-method dyndns
awplus(config-ddns-update-method)# update-interval 1440
```

To enable periodic DDNS updates every 28 days for the method "dyndns", use the commands:

```
awplus# configure terminal
awplus(config)# ddns-update-method dyndns
awplus(config-ddns-update-method)# update-interval 40320
```

To disable periodic DDNS updates for the method "dyndns", use the commands:

```
awplus# configure terminal
awplus(config)# ddns-update-method dyndns
awplus(config-ddns-update-method)# no update-interval
```

Related commands [ddns-update-method](#)

Command changes Version 5.4.7-0.1: command added

update-url (ddns-update-method)

Overview Use this command to configure a URL for DDNS updates for the current DDNS update method.

Use the **no** variant of this command to remove an update URL from a DDNS update method.

Syntax `update-url <url-name>`
`no update-url <url-name>`

Parameter	Description
<url-name>	The update URL is provided by the DDNS provider and can be configured with the following placeholder tokens: <ul style="list-style-type: none">• <USERNAME>• <PASSWORD>• <HOST-NAME>• <IPADDRESS> To specify the values for <USERNAME>, <PASSWORD> and <HOST-NAME>, use the commands username , password and hostname . The value for <IPADDRESS> is populated automatically from the interface IP settings.

Default None

Mode Dynamic DNS Update Method Configuration

Usage notes The update URL (provided by the DDNS provider) can include a user name, password, host name and/or IP address. These user values are optional because they may vary depending on the DDNS provider's update URLs. AlliedWare Plus requires you to enter the required parameters for the update URL using the following placeholder tokens:

- for the user name enter "<USERNAME>"
- for the password enter "<PASSWORD>"
- for the host name enter "<HOST-NAME>"
- for the IP address enter "<IPADDRESS>"

For example, for DynDNS the following update URL can be used:

```
http://username:password@members.dyndns.org/nic/update?  
SYSTEM=dyndns&hostname=<h>&myip=<a>
```

To configure this URL, use the following command including the placeholder tokens as written here:

```
awplus(config-ddns-update-method)# update-url  
http://<USERNAME>:<PASSWORD>@members.dyndns.org/nic/update?  
SYSTEM=dyndns&hostname=<HOST-NAME>&myip=<IPADDRESS>
```

DynDNS also has the following update URL that can be used instead:

```
http://<USERNAME>:<PASSWORD>@members.dyndns.org/v3/update?  
hostname=<HOST-NAME>&myip=<IPADDRESS>
```

NOTE: URLs that contain the character "?" activate help from the command line. To stop the help from activating enter the "?" in the command line, then press Ctrl+v.

For more information and examples, see the [Domain Name System \(DNS\) for AlliedWare Plus AR-Series Firewalls Feature Overview and Configuration Guide](#).

Examples To use members.dyndns.org/nic/update as the update URL for the provider DynDNS, with the method called "dyndns" that uses HTTP, use the following commands:

```
awplus# configure terminal  
awplus(config)# ddns-update-method dyndns  
awplus(config-ddns-update-method)# update-url  
http://<USERNAME>:<PASSWORD>@members.dyndns.org/nic/update?  
SYSTEM=dyndns&hostname=<HOST-NAME>&myip=<IPADDRESS>
```

To use members.dyndns.org/v3/update as the update URL for the provider DynDNS, with the method called "dyndns" that uses HTTP, use the following commands:

```
awplus# configure terminal  
awplus(config)# ddns-update-method dyndns  
awplus(config-ddns-update-method)# update-url  
http://<USERNAME>:<PASSWORD>@members.dyndns.org/v3/update?  
hostname=<HOST-NAME>&myip=<IPADDRESS>
```

To use members.dyndns.org/v3/update as the update URL for the provider DynDNS, with the method called "dyndns" that uses HTTPS/SSL, use the following commands:

```
awplus# configure terminal  
awplus(config)# ddns-update-method dyndns  
awplus(config-ddns-update-method)# update-url  
https://<USERNAME>:<PASSWORD>@members.dyndns.org/v3/update?  
hostname=<HOST-NAME>&myip=<IPADDRESS>
```

To use members.dyndns.org/v3/update as the update URL for the provider DynDNS, with the method called "dyndns" that uses HTTP on port 8245, use the following commands:

```
awplus# configure terminal  
awplus(config)# ddns-update-method dyndns  
awplus(config-ddns-update-method)# update-url  
http://<USERNAME>:<PASSWORD>@members.dyndns.org:8245/v3/  
update?hostname=<HOST-NAME>&myip=<IPADDRESS>
```

To remove the update URL from the method called “dyndns”, use the following commands:

```
awplus# configure terminal
awplus(config)# ddns-update-method dyndns
awplus(config-ddns-update-method)# no update-url
```

Related commands [ddns-update-method](#)

Command changes Version 5.4.7-0.1: command added

use-ipv4-for-ipv6-updates

Overview Use this command to send IPv6 updates using IPv4.
Use the **no** variant of this command to stop sending IPv6 updates using IPv4.

Syntax `use-ipv4-for-ipv6-updates`
`no use-ipv4-for-ipv6-updates`

Default Disabled

Mode Dynamic DNS Update Method Configuration

Usage notes If your DDNS provider supports IPv6 but does not support sending updates in IPv6 then this command is used so IPv6 updates can be sent using IPv4 instead. The **suppress-ipv4-updates** command is used in conjunction with this command to suppress IPv4 updates and send only IPv6 updates instead.

example To send IPv6 updates using IPv4 for the method "dyndns" and to suppress IPv4 updates, use the commands:

```
awplus# configure terminal
awplus(config)# ddns-update-method dyndns
awplus(config-ddns-update-method)# use-ipv4-for-ipv6-updates
awplus(config-ddns-update-method)# suppress-ipv4-updates
```

Related commands [ddns-update-method](#)
[suppress-ipv4-updates](#)

Command changes Version 5.4.7-0.1: command added

username (ddns-update-method)

Overview Use this command to add a user name to the current DDNS update method.
Use the **no** variant of this command to remove a user name from the current DDNS update method.

Syntax `username <user-name>`
`no username`

Parameter	Description
<code><user-name></code>	The name of the user to be configured in conjunction with the password and host name.

Default None

Mode Dynamic DNS Update Method Configuration

Example To configure the username "atlnz" for the method "dyndns", use the following commands:

```
awplus# configure terminal
awplus(config)# ddns-update-method dyndns
awplus(config-ddns-update-method)# username atlnz
```

To remove the username "atlnz" from the method "dyndns", use the following commands:

```
awplus# configure terminal
awplus(config)# ddns-update-method dyndns
awplus(config-ddns-update-method)# no username
```

Related commands [ddns-update-method](#)

Command changes Version 5.4.7-0.1: command added

23

IPv6 Commands

Introduction

Overview This chapter provides an alphabetical reference of commands used to configure IPv6. For more information, see the [IPv6 Feature Overview and Configuration Guide](#).

- Command List**
- “clear ipv6 neighbors” on page 868
 - “ipv6 address” on page 869
 - “ipv6 address autoconfig” on page 871
 - “ipv6 address suffix” on page 873
 - “ipv6 enable” on page 874
 - “ipv6 eui64-linklocal” on page 876
 - “ipv6 forwarding” on page 877
 - “ipv6 icmp error-interval” on page 878
 - “ipv6 multicast forward-slow-path-packet” on page 879
 - “ipv6 multihoming” on page 880
 - “ipv6 nd accept-ra-default-routes” on page 881
 - “ipv6 nd accept-ra-pinfo” on page 882
 - “ipv6 nd current-hoplimit” on page 883
 - “ipv6 nd dns search-list” on page 885
 - “ipv6 nd dns-server” on page 886
 - “ipv6 nd managed-config-flag” on page 888
 - “ipv6 nd minimum-ra-interval” on page 889
 - “ipv6 nd other-config-flag” on page 891
 - “ipv6 nd prefix” on page 892

- [“ipv6 nd proxy interface”](#) on page 894
- [“ipv6 nd ra-interval”](#) on page 896
- [“ipv6 nd ra-lifetime”](#) on page 897
- [“ipv6 nd reachable-time”](#) on page 899
- [“ipv6 nd retransmission-time”](#) on page 901
- [“ipv6 nd route-information”](#) on page 903
- [“ipv6 nd router-preference”](#) on page 904
- [“ipv6 nd suppress-ra”](#) on page 905
- [“ipv6 neighbor”](#) on page 906
- [“ipv6 opportunistic-nd”](#) on page 907
- [“ipv6 route”](#) on page 908
- [“ipv6 unreachable”](#) on page 910
- [“optimistic-nd”](#) on page 911
- [“ping ipv6”](#) on page 912
- [“show ipv6 forwarding”](#) on page 914
- [“show ipv6 interface”](#) on page 915
- [“show ipv6 neighbors”](#) on page 917
- [“show ipv6 route”](#) on page 918
- [“show ipv6 route summary”](#) on page 920
- [“traceroute ipv6”](#) on page 921

clear ipv6 neighbors

Overview Use this command to clear all dynamic IPv6 neighbor entries.

Syntax `clear ipv6 neighbors`

Mode Privileged Exec

Example `awplus# clear ipv6 neighbors`

Related commands [ipv6 neighbor](#)
[show ipv6 neighbors](#)

ipv6 address

Overview Use this command to set the IPv6 address of an interface. The command also enables IPv6 on the interface, which creates an EUI-64 link-local address as well as enabling RA processing and SLAAC.

To stop the device from processing prefix information (routes and addresses from the received Router Advertisements) use the command **no ipv6 nd accept-ra-pinfo**.

To remove the EUI-64 link-local address, use the command **no ipv6 eui64-linklocal**.

Use the **no** variant of this command to remove the IPv6 address assigned and disable IPv6. Note that if no global addresses are left after removing the IPv6 address then IPv6 is disabled.

Syntax `ipv6 address <ipv6-addr/prefix-length>`
`no ipv6 address <ipv6-addr/prefix-length>`

Parameter	Description
<code><ipv6-addr/prefix-length></code>	Specifies the IPv6 address to be set. The IPv6 address uses the format X:X::X/Prefix-Length. The prefix-length is usually set between 0 and 64.

Mode Interface Configuration for a VLAN interface, an Eth interface, an 802.1Q sub-interface, a local loopback interface, a PPP interface, a bridge, or a tunnel.

Usage notes Note that the device keeps link-local addresses until you remove them with the **no** variant of the command that established them. See the [ipv6 enable](#) command for more information.

Also note that the device keeps the link-local address if the global address is removed using a command other than the command that was used to establish the link-local address. For example, if a link local address is established with the [ipv6 enable](#) command then it will not be removed using a **no ipv6 address** command.

Examples To assign the IPv6 address 2001:0db8::a2/64 to eth1, use the commands:

```
awplus# configure terminal
awplus(config)# interface eth1
awplus(config-if)# ipv6 address 2001:0db8::a2/64
```

To remove the IPv6 address 2001:0db8::a2/64 from eth1, use the commands:

```
awplus# configure terminal
awplus(config)# interface eth1
awplus(config-if)# no ipv6 address 2001:0db8::a2/64
```

To assign the IPv6 address to the PPP interface ppp0, use the commands:

```
awplus# configure terminal
awplus(config)# interface ppp0
awplus(config-if)# ipv6 address 2001:0db8::a2/64
```

To assign the IPv6 address to the tunnel tunnel0, use the commands:

```
awplus# configure terminal
awplus(config)# interface tunnel0
awplus(config-if)# ipv6 address 2001:0db8::a2/64
```

To remove the IPv6 address 2001:0db8::a2/64 from the PPP interface ppp0, use the commands:

```
awplus# configure terminal
awplus(config)# interface ppp0
awplus(config-if)# no ipv6 address 2001:0db8::a2/64
```

**Related
commands**

[ipv6 address autoconfig](#)

[ipv6 address dhcp](#)

[ipv6 dhcp server](#)

[ipv6 enable](#)

[ipv6 eui64-linklocal](#)

[show running-config](#)

[show ipv6 interface](#)

[show ipv6 route](#)

ipv6 address autoconfig

Overview Use this command to enable IPv6 stateless address autoconfiguration (SLAAC) for an interface. This configures an IPv6 address on an interface derived from the MAC address on the interface.

Use the **no** variant of this command to disable IPv6 SLAAC on an interface. Note that if no global addresses are left after removing all IPv6 autoconfigured addresses then IPv6 is disabled.

Syntax `ipv6 address autoconfig`
`no ipv6 address autoconfig`

Mode Interface Configuration for a VLAN interface, an Eth interface, an 802.1Q sub-interface, a local loopback interface, a PPP interface, a bridge, or a tunnel.

Usage notes Use this command to enable automatic configuration of IPv6 addresses using stateless autoconfiguration on an interface, and enable IPv6.

IPv6 hosts can configure themselves when connected to an IPv6 network using ICMPv6 (Internet Control Message Protocol version 6) router discovery messages. Configured routers respond with a Router Advertisement (RA) containing configuration parameters for IPv6 hosts.

The SLAAC process derives the interface identifier of the IPv6 address from the MAC address of the interface.

When applying SLAAC to an interface, note that the MAC address of the default VLAN is applied to the interface if the interface does not have its own MAC address.

If SLAAC is not suitable then a network can use stateful configuration with DHCPv6 (Dynamic Host Configuration Protocol version 6) Relay, or hosts can be configured statically. See [ip dhcp-relay server-address](#) for the DHCPv6 Relay server command description and examples. See the [IP Feature Overview and Configuration Guide](#) for more information about DNS Relay.

Note that the device keeps link-local addresses until you remove them with the **no** variant of the command that established them. See the [ipv6 enable](#) command for more information.

Also note that the device keeps the link-local address if the global address is removed using a command other than the command that was used to establish the link-local address. For example, if a link local address is established with the [ipv6 enable](#) command then it will not be removed using a **no ipv6 address** command.

Examples To enable SLAAC on eth1, use the commands:

```
awplus# configure terminal
awplus(config)# interface eth1
awplus(config-if)# ipv6 address autoconfig
```

To disable SLAAC on eth1, use the commands:

```
awplus# configure terminal
awplus(config)# interface eth1
awplus(config-if)# no ipv6 address autoconfig
```

**Related
commands**

[ipv6 address](#)
[ipv6 enable](#)
[show ipv6 interface](#)
[show running-config](#)

ipv6 address suffix

Overview Use this command to configure the suffix to use when generating an address from prefix information. Any addresses that were created with the EUI-64 suffix will be removed, and new addresses will be added after the next Router Advertisement.

Use the **no** variant of this command to set it back to the default of disabled or set to `::` for the same result as the **no** variant.

Syntax `ipv6 address suffix <ipv6-addr-suffix>`
`no ipv6 address suffix`

Parameter	Description
<code><ipv6-addr-suffix></code>	In the format of <code>::X:X:X:X</code> , for example <code>::a2d8:0fd8</code>

Default Disabled

Mode Interface Configuration for a VLAN interface, an Eth interface, an 802.1Q sub-interface, a local loopback interface, a PPP interface, a bridge, or a tunnel.

Example To configure the suffix to use when generating an address from prefix information on eth1, use the command:

```
awplus# configure terminal
awplus(config)# interface eth1
awplus(config-if)# ipv6 address suffix ::a2d8:0fd8
```

Related commands [ipv6 nd accept-ra-pinfo](#)
[show running-config interface](#)

Command changes Version 5.4.8-2.1: command added

ipv6 enable

Overview Use this command to enable automatic configuration of a link-local IPv6 address on an interface using Stateless Automatic Address Configuration (SLAAC). By default, the EUI-64 method is used to generate the link-local address.

Use the **no** variant of this command to disable IPv6 on an interface without a global address. Note, to stop EUI-64 from generating the automatic link-local address, use the command **no ipv6 eui64-linklocal**.

Syntax `ipv6 enable`
`no ipv6 enable`

Mode Interface Configuration for a VLAN interface, an Eth interface, an 802.1Q sub-interface, a local loopback interface, a PPP interface, a bridge, or a tunnel.

Usage notes The **ipv6 enable** command automatically configures an IPv6 link-local address on the interface and enables the interface for IPv6 processing.

A link-local address is an IP (Internet Protocol) address that is only used for communications in the local network, or for a point-to-point connection. Routing does not forward packets with link-local addresses. IPv6 requires that a link-local address is assigned to each interface that has the IPv6 protocol enabled, and when addresses are assigned to interfaces for routing IPv6 packets.

Note that the device keeps link-local addresses until you remove them with the **no** variant of the command that established them.

Also note that the device keeps the link-local address if the global address is removed using a command other than the command that was used to establish the link-local address. For example, if a link local address is established with the `ipv6 enable` command then it will not be removed using a **no ipv6 address** command.

Default All interfaces default to IPv6-down with no address.

Examples To enable IPv6 with only a link-local IPv6 address on eth1, use the following commands:

```
awplus# configure terminal
awplus(config)# interface eth1
awplus(config-if)# ipv6 enable
```

To disable IPv6 with only a link-local IPv6 address on eth1, use the following commands:

```
awplus# configure terminal
awplus(config)# interface eth1
awplus(config-if)# no ipv6 enable
```

To enable IPv6 with only a link-local IPv6 address on the PPP interface ppp0, use the following commands:

```
awplus# configure terminal
awplus(config)# interface ppp0
awplus(config-if)# ipv6 enable
```

To disable IPv6 with only a link-local IPv6 address on the PPP interface ppp0, use the following commands:

```
awplus# configure terminal
awplus(config)# interface ppp0
awplus(config-if)# no ipv6 enable
```

**Related
commands**

- [ipv6 address](#)
- [ipv6 address autoconfig](#)
- [ipv6 address dhcp](#)
- [ipv6 address \(DHCPv6 PD\)](#)
- [ipv6 dhcp client pd](#)
- [ipv6 nd prefix](#)
- [show ipv6 interface](#)
- [show ipv6 route](#)
- [show running-config](#)

ipv6 eui64-linklocal

Overview When IPv6 is enabled on an interface, an EUI link-local address is generated and installed on the interface. In other words, **ipv6 eui64-linklocal** is enabled by default on any IPv6 enabled interface.

Use the **no** variant of this command to disallow the automatic generation of the EUI-64 link-local address on an IPv6 enabled interface.

Syntax `ipv6 eui64-linklocal`
`no ipv6 eui64-linklocal`

Default The command **ipv6 eui64-linklocal** is enabled by default on any IPv6 enabled interface.

Mode Interface Configuration for a VLAN interface, an Eth interface, an 802.1Q sub-interface, a local loopback interface, a PPP interface, a bridge, or a tunnel.

Example To enable IPv6 on an interface eth1, and use the link-local address of fe80::1/10 instead of the EUI-64 link-local that is automatically generated, use the following commands:

```
awplus# configure terminal
awplus(config)# interface eth1
awplus(config-if)# ipv6 enable
awplus(config-if)# no ipv6 eui64-linklocal
awplus(config-if)# ipv6 address fe80::1/10
```

Related commands [ipv6 address](#)
[ipv6 address autoconfig](#)
[ipv6 enable](#)

Command changes Version 5.4.7-0.1: command added

ipv6 forwarding

Overview Use this command to turn on IPv6 unicast routing for IPv6 packet forwarding. Use this command globally on your device before using the [ipv6 enable](#) command on individual interfaces. Use the **no** variant of this command to turn off IPv6 unicast routing. Note IPv6 unicast routing is disabled by default.

Syntax `ipv6 forwarding`
`no ipv6 forwarding`

Mode Global Configuration

Default IPv6 unicast forwarding is disabled by default.

Usage notes Enable IPv6 unicast forwarding globally for all interfaces on your device with this command. Use the **no** variant of this command to disable IPv6 unicast forwarding globally for all interfaces on your device.

IPv6 unicast forwarding allows devices to communicate with devices that are more than one hop away, providing that there is a route to the destination address. If IPv6 forwarding is not enabled then pings to addresses on devices that are more than one hop away will fail, even if there is a route to the destination address.

Examples To enable IPv6 unicast routing, use the commands:

```
awplus# configure terminal
awplus(config)# ipv6 forwarding
```

To disable IPv6 unicast routing, use the commands:

```
awplus# configure terminal
awplus(config)# no ipv6 forwarding
```

Related commands [ipv6 enable](#)
[ipv6 multicast-routing](#)

ipv6 icmp error-interval

Overview Use this command to limit how often IPv6 ICMP error messages are sent. The maximum frequency of messages is specified in milliseconds.

Use the **no** variant of this command to reset the frequency to the default

Syntax `ipv6 icmp error-interval <interval>`
`no ipv6 icmp error-interval`

Parameter	Description
<interval>	0-2147483647, interval in milliseconds.

Default 1000

Mode Global Configuration

Example To configure the rate to be at most one packet every 10 seconds, use the commands:

```
awplus# configure terminal
awplus(config)# ipv6 icmp error-interval 10000
```

To reset the rate to the default of one packet every second, use the commands:

```
awplus# configure terminal
awplus(config)# no ipv6 icmp error-interval
```

Related commands [ip icmp error-interval](#)

ipv6 multicast forward-slow-path-packet

Overview Use this command to enable multicast packets to be forwarded to the CPU. Enabling this command will ensure that the layer L3 MTU is set correctly for each IP multicast group and will apply the value of the smallest MTU among the outgoing interfaces for the multicast group.

It will also ensure that a received packet that is larger than the MTU value will result in the generation of an ICMP Too Big message.

Use the **no** variant of this command to disable the above functionality.

Syntax `ipv6 multicast forward-slow-path-packet`
`no ipv6 multicast forward-slow-path-packet`

Default Disabled.

Mode Privileged Exec

Example To enable the ipv6 multicast forward-slow-path-packet function, use the following commands:

```
awplus# configure terminal
awplus(config)# ip multicast forward-slow-path-packet
```

Related commands [show ipv6 forwarding](#)

ipv6 multihoming

Overview Use this command to enable IPv6 multihoming. IPv6 multihoming dynamically adds IPv6 routes, with source prefixes, based on Neighbor Discovery Protocol (NDP) utilizing the Router Advertisements (RAs).

This allows segregation of traffic between multiple gateways, which is useful for sending traffic to multiple ISPs for increased redundancy and load balancing.

Use the **no** variant of this command to disable IPv6 multihoming.

Syntax `ipv6 multihoming`
`no ipv6 multihoming`

Default Disabled

Mode Interface Configuration

Usage notes Note that static IPv6 source address dependent routes do not require this feature.

Examples To configure IPv6 multihoming, use the commands:

```
awplus# configure terminal
awplus(config)# interface eth1
awplus(config-if)# ipv6 multihoming
```

To disable IPv6 multihoming, use the commands:

```
awplus# configure terminal
awplus(config)# interface eth1
awplus(config-if)# no ipv6 multihoming
```

Related commands [ipv6 route](#)

Command changes Version 5.5.0-0.3: command added

ipv6 nd accept-ra-default-routes

Overview Use this command to allow accepting and installing of default routes based on a received RA (Router Advertisement). The default route's destination is set to the source address of the received RA.

Use the **no** variant of this command to disable accepting RA-based default routes.

Syntax `ipv6 nd accept-ra-default-routes`
`no ipv6 nd accept-ra-default-routes`

Default RA-based default routes are accepted by default.

Mode Interface Configuration for a VLAN interface, an Eth interface, an 802.1Q sub-interface, a local loopback interface, a PPP interface, a bridge, or a tunnel.

Example To enable RA-based default routes on eth1, use the following commands:

```
awplus# configure terminal
awplus(config)# interface eth1
awplus(config-if)# ipv6 nd accept-ra-default-routes
```

Related commands [ipv6 address](#)
[ipv6 address autoconfig](#)
[ipv6 enable](#)

ipv6 nd accept-ra-pinfo

Overview Use this command to allow the processing of the prefix information included in a received RA (Router Advertisement) on an IPv6 enabled interface.

Use the **no** variant of this command to disable an IPv6 interface from using the prefix information within a received RA.

Syntax `ipv6 nd accept-ra-pinfo`
`no ipv6 nd accept-ra-pinfo`

Default The command **ipv6 nd accept-ra-pinfo** is enabled by default on any IPv6 interface.

Mode Interface Configuration for a VLAN interface, an Eth interface, an 802.1Q sub-interface, a local loopback interface, a PPP interface, a bridge, or a tunnel.

Usage notes By default, when IPv6 is enabled on an interface, SLAAC is also enabled. SLAAC addressing along with the EUI-64 process, uses the prefix information included in a received RA to generate an automatic link-local address on the IPv6 interface.

Note: an AlliedWare Plus device will, by default, add a prefix for the connected interface IPv6 address(es) to the RA it transmits. However, this behavior can be changed by using the command **no ipv6 nd prefix auto-advertise**, so there is no guarantee that an RA will contain a prefix.

Example To enable IPv6 on eth1 without installing a SLAAC address on the interface, use the following commands:

```
awplus# configure terminal
awplus(config)# interface eth1
awplus(config-if)# ipv6 enable
awplus(config-if)# no ipv6 nd accept-ra-pinfo
```

Related commands [ipv6 address](#)
[ipv6 address autoconfig](#)
[ipv6 enable](#)

Command changes Version 5.4.7-0.1: command added

ipv6 nd current-hoplimit

Overview Use this command to specify the advertised current hop limit used between IPv6 Routers.

Use the **no** variant of this command to reset the current advertised hop limit to the default of 0, which means no advertised current hop limit is specified.

Syntax `ipv6 nd current-hoplimit <hoplimit>`
`no ipv6 nd current-hoplimit`

Parameter	Description
<code><hoplimit></code>	Specifies the advertised current hop limit value. Valid values are from 0 to 255 hops.

Default 0 (No advertised current hop limit specified)

Mode Interface Configuration for a VLAN interface, an Eth interface, an 802.1Q sub-interface, a local loopback interface, a PPP interface, a bridge, or a tunnel.

Examples To set the advertised current hop limit to 2 between IPv6 Routers on eth1, use the following commands:

```
awplus# configure terminal
awplus(config)# interface eth1
awplus(config-if)# ipv6 nd current-hoplimit 2
```

To reset the advertised current hop limit to the default 0 on eth1, use the following commands:

```
awplus# configure terminal
awplus(config)# interface eth1
awplus(config-if)# no ipv6 nd current-hoplimit
```

To set the advertised current hop limit to 2 between IPv6 Routers on ppp0, use the following commands:

```
awplus# configure terminal
awplus(config)# interface ppp0
awplus(config-if)# ipv6 nd current-hoplimit 2
```

To reset the advertised current hop limit to the default 0 on ppp0, use the following commands:

```
awplus# configure terminal
awplus(config)# interface ppp0
awplus(config-if)# no ipv6 nd current-hoplimit
```

Related commands [ipv6 nd managed-config-flag](#)
[ipv6 nd prefix](#)
[ipv6 nd suppress-ra](#)

ipv6 nd dns search-list

Overview Use this command to specify a DNS Search List (DNSSL) to be included in the Router Advertisement for a given IPv6 interface.

Use the **no** variant of this command to remove a specified domain name. If no domain name is specified, then all domain names previously added will be deleted.

Syntax `ipv6 nd dns search-list <domain-name>`
`no ipv6 nd dns search-list [<domain-name>]`

Parameter	Description
<code><domain-name></code>	A string specifying the domain name to be added to the search list. For example, myexample.com

Default No domain search list is included in router advertisements from any interface.

Mode Interface Configuration for a VLAN interface, an Eth interface, an 802.1Q sub-interface, a local loopback interface, a PPP interface, a bridge, or a tunnel.

Example To add the domain name 'myexample.com' to the search list for vlan2, use the commands:

```
awplus# configure terminal
awplus(config)# interface vlan2
awplus(config-if)# ipv6 nd dns search-list myexample.com
```

To delete all domain names added previously, use the commands:

```
awplus# configure terminal
awplus(config)# interface vlan2
awplus(config-if)# no ipv6 nd dns search-list
```

Related commands [ipv6 nd suppress-ra](#)

Command changes Version 5.5.0-2.5: command added

ipv6 nd dns-server

Overview Use this command to advertise (in Router Advertisement messages) a DNS server for downstream devices to use.

You can specify either a static IPv6 address or the lowest address from an interface.

Use the **no** variant of this command to delete one or all DNS server addresses.

Syntax `ipv6 nd dns-server {<int>|<ip-add>}`
`no ipv6 nd dns-server [<int>|<ip-add>]`

Parameter	Description
<int>	Advertise the lowest IPv6 address on the selected interface as a DNS server for downstream devices.
<ip-add>	Advertise a particular IPv6 address as a DNS server for downstream devices.

Default No DNS servers are advertised.

Mode Interface Configuration for a VLAN interface, an Eth interface, an 802.1Q sub-interface, a local loopback interface, a PPP interface, a bridge, or a tunnel.

Example To configure eth1 to send RAs and advertise itself as a DNS server, use the commands:

```
awplus# configure terminal
awplus(config)# interface eth1
awplus(config-if)# no ipv6 nd suppress-ra
awplus(config-if)# no ipv6 nd accept-ra-pinfo
awplus(config-if)# ipv6 address 2001:DB8::1/64
awplus(config-if)# ipv6 nd dns-server eth1
```

To configure eth1 to send RAs and advertise 2001:DB8::2 as a DNS server, use the commands:

```
awplus# configure terminal
awplus(config)# interface eth1
awplus(config-if)# no ipv6 nd suppress-ra
awplus(config-if)# no ipv6 nd accept-ra-pinfo
awplus(config-if)# ipv6 address 2001:DB8::1/64
awplus(config-if)# ipv6 nd dns-server 2001:DB8::2
```

To stop advertising any DNS servers on the selected interface, use the commands:

```
awplus# configure terminal
awplus(config)# interface eth1
awplus(config-if)# no ipv6 nd dns-server
```

Related commands

- [ipv6 nd accept-ra-pinfo](#)
- [ipv6 nd suppress-ra](#)
- [show ipv6 interface](#)

ipv6 nd managed-config-flag

Overview Use this command to set the managed address configuration flag, contained within the router advertisement field.

Setting this flag indicates the operation of a stateful autoconfiguration protocol such as DHCPv6 for address autoconfiguration, and that address information (i.e. the network prefix) and other (non-address) information can be requested from the device.

An unset flag enables hosts receiving the advertisements to use a stateless autoconfiguration mechanism to establish their IPv6 addresses. The default is flag unset.

Use the **no** variant of this command to reset this command to its default of having the flag unset.

Syntax `ipv6 nd managed-config-flag`
`no ipv6 nd managed-config-flag`

Default Unset

Mode Interface Configuration for a VLAN interface, an Eth interface, an 802.1Q sub-interface, a local loopback interface, a PPP interface, a bridge, or a tunnel.

Usage notes To enable the transmission of router advertisements, you must apply the **no** version of the [ipv6 nd suppress-ra](#) command. This step is included in the example below.

Example To set the managed address configuration flag on eth1, use the following commands:

```
awplus# configure terminal
awplus(config)# interface eth1
awplus(config-if)# ipv6 nd managed-config-flag
awplus(config-if)# no ipv6 nd suppress-ra
```

To set the managed address configuration flag on the PPP interface ppp0, use the following commands:

```
awplus# configure terminal
awplus(config)# interface ppp0
awplus(config-if)# ipv6 nd managed-config-flag
awplus(config-if)# no ipv6 nd suppress-ra
```

Related commands [ipv6 nd suppress-ra](#)
[ipv6 nd prefix](#)
[ipv6 nd other-config-flag](#)

ipv6 nd minimum-ra-interval

Overview Use this command in Interface Configuration mode to set a minimum Router Advertisement (RA) interval for an interface.

Use the **no** variant of this command in Interface Configuration mode to remove the minimum RA interval for an interface.

Syntax `ipv6 nd minimum-ra-interval <seconds>`
`no ipv6 nd minimum-ra-interval`

Parameter	Description
<code><seconds></code>	Specifies the number of seconds between IPv6 Router Advertisements (RAs). Valid values are from 3 to 1350 seconds.

Default The RA interval for an interface is unset by default.

Mode Interface Configuration for a VLAN interface, an Eth interface, an 802.1Q sub-interface, a local loopback interface, a PPP interface, a bridge, or a tunnel.

Examples To set the minimum RA interval for eth1, use the following commands:

```
awplus# configure terminal
awplus(config)# interface eth1
awplus(config-if)# ipv6 nd minimum-ra-interval 60
```

To remove the minimum RA interval for eth1, use the following commands:

```
awplus# configure terminal
awplus(config)# interface eth1
awplus(config-if)# no ipv6 nd minimum-ra-interval
```

To set the minimum RA interval for the PPP interface ppp0, use the following commands:

```
awplus# configure terminal
awplus(config)# interface ppp0
awplus(config-if)# ipv6 nd minimum-ra-interval 60
```

To remove the minimum RA interval for the PPP interface ppp0, use the following commands:

```
awplus# configure terminal
awplus(config)# interface ppp0
awplus(config-if)# no ipv6 nd minimum-ra-interval
```

Related commands

- ipv6 nd ra-interval
- ipv6 nd suppress-ra
- ipv6 nd prefix
- ipv6 nd other-config-flag

ipv6 nd other-config-flag

Overview Use this command to set the **other** stateful configuration flag (contained within the router advertisement field) to be used for IPv6 address auto-configuration. This flag is used to request the router to provide information in addition to providing addresses.

Setting the `ipv6 nd managed-config-flag` command implies that the `ipv6 nd other-config-flag` will also be set.

Use **no** variant of this command to reset the value to the default.

Syntax `ipv6 nd other-config-flag`
`no ipv6 nd other-config-flag`

Default Unset

Mode Interface Configuration for a VLAN interface, an Eth interface, an 802.1Q sub-interface, a local loopback interface, a PPP interface, a bridge, or a tunnel.

Usage notes To enable the transmission of router advertisements, you must apply the **no** version of the `ipv6 nd suppress-ra` command. This step is included in the example below.

Example To set the IPv6 other-config-flag on eth1, use the following commands:

```
awplus# configure terminal
awplus(config)# interface eth1
awplus(config-if)# ipv6 nd other-config-flag
awplus(config-if)# no ipv6 nd suppress-ra
```

To set the IPv6 other-config-flag on the PPP interface ppp0, use the following commands:

```
awplus# configure terminal
awplus(config)# interface ppp0
awplus(config-if)# ipv6 nd other-config-flag
awplus(config-if)# no ipv6 nd suppress-ra
```

Related commands [ipv6 nd suppress-ra](#)
[ipv6 nd prefix](#)
[ipv6 nd managed-config-flag](#)

ipv6 nd prefix

Overview Use this command in Interface Configuration mode to specify the IPv6 prefix information that is advertised by the router advertisement for IPv6 address auto-configuration.

Use the **no** parameter with this command to reset the IPv6 prefix for an interface in Interface Configuration mode.

Syntax

```

ipv6 nd prefix <ipv6-prefix/length>
ipv6 nd prefix <ipv6-prefix/length> <valid-lifetime>
ipv6 nd prefix <ipv6-prefix/length> <valid-lifetime>
<preferred-lifetime> [no-autoconfig]
ipv6 nd prefix <ipv6-prefix/length> <valid-lifetime>
<preferred-lifetime> off-link [no-autoconfig]
no ipv6 nd prefix [<ipv6-addr/prefix-length>|all]

```

Parameter	Description
<ipv6-prefix/length>	The prefix to be advertised by the router advertisement message. The IPv6 address prefix uses the format X:X::/prefix-length. The prefix-length is usually set between 0 and 64. The default is X:X::/64.
<valid-lifetime>	The the period during which the specified IPv6 address prefix is valid. This can be set to a value between 0 and 4294967295 seconds. The default is 2592000 (30 days). Note that this period should be set to a value greater than that set for the prefix preferred-lifetime.
<preferred-lifetime>	Specifies the IPv6 prefix preferred lifetime. This is the period during which the IPv6 address prefix is considered a current (undeprecated) value. After this period, the command is still valid but should not be used in new communications. Set to a value between 0 and 4294967295 seconds. The default is 604800 seconds (7 days). Note that this period should be set to a value less than that set for the prefix valid-lifetime.
off-link	Specify the IPv6 prefix off-link flag. The default is flag set.
no-autoconfig	Specify the IPv6 prefix no autoconfiguration flag. Setting this flag indicates that the prefix is not to be used for autoconfiguration. The default is flag set.
all	Specify all IPv6 prefixes associated with the interface.

Default Valid-lifetime default is 2592000 seconds (30 days). Preferred-lifetime default is 604800 seconds (7 days).

Mode Interface Configuration for a VLAN interface, an Eth interface, an 802.1Q sub-interface, a local loopback interface, a PPP interface, a bridge, or a tunnel.

Usage notes This command specifies the IPv6 prefix flags that are advertised by the router advertisement message.

Examples To configure the device to issue router advertisements on eth1, and advertise the address prefix of 2001:0db8::/64, use the commands:

```
awplus# configure terminal
awplus(config)# interface eth1
awplus(config-if)# ipv6 nd prefix 2001:0db8::/64
```

To configure the device to issue router advertisements on eth1, and advertise the address prefix of 2001:0db8::/64 with a valid lifetime of 10 days and a preferred lifetime of 5 days, use the commands:

```
awplus# configure terminal
awplus(config)# interface eth1
awplus(config-if)# ipv6 nd prefix 2001:0db8::/64 864000 432000
```

To configure the device to issue router advertisements on eth1 and advertise the address prefix of 2001:0db8::/64 with a valid lifetime of 10 days, a preferred lifetime of 5 days, and no prefix used for autoconfiguration, use the commands:

```
awplus# configure terminal
awplus(config)# interface eth1
awplus(config-if)# ipv6 nd prefix 2001:0db8::/64 864000 432000
no-autoconfig
```

To reset router advertisements on eth1, so the address prefix of 2001:0db8::/64 is not advertised from the device, use the commands:

```
awplus# configure terminal
awplus(config)# interface eth1
awplus(config-if)# no ipv6 nd prefix 2001:0db8::/64
```

To reset all router advertisements on eth1, use the commands:

```
awplus# configure terminal
awplus(config)# interface eth1
awplus(config-if)# no ipv6 nd prefix all
```

Related commands [ipv6 nd suppress-ra](#)

ipv6 nd proxy interface

Overview Use this command to enable the neighbor discovery proxy that forwards Neighbor Solicitations (NS) and Neighbor Advertisements (NA) between two interfaces.

Use the **no** variant of this command to disable the neighbor discovery proxy.

Syntax `ipv6 nd proxy interface <interface-name>`
`no ipv6 nd proxy`

Parameter	Description
<code><interface-name></code>	The name of the VLAN, Ethernet or Bridge interface to proxy NS and NA from/to. For example <i>vlan1</i> , <i>eth1</i> or <i>br1</i> .

Default No ND proxy is enabled

Mode Interface Configuration for VLAN, Eth, WWAN, and bridge interfaces and 802.1Q sub-interfaces.

Examples To enable neighbor discovery proxy on eth1, and forward NS and NA to vlan1, use the commands:

```
awplus# configure terminal
awplus(config)# interface eth1
awplus(config-if)# ipv6 nd proxy interface vlan1
```

To disable neighbor discovery proxy on eth1, use the commands:

```
awplus# configure terminal
awplus(config)# interface eth1
awplus(config-if)# no ipv6 nd proxy
```

Example running configuration output to enable neighbor discovery proxy between eth1 and br1:

```
!  
bridge 1  
!  
int vlan1  
  bridge-group 1  
!  
int vlan2  
  bridge-group 1  
!  
interface eth1  
  ipv6 enable  
  ipv6 nd proxy interface br1  
!  
interface br1  
  ipv6 enable  
  ipv6 nd proxy interface eth1  
  ipv6 address autoconfig eth1  
!
```

Related commands [show running-config](#)

Command changes Version 5.4.8-1.1: command added

ipv6 nd ra-interval

Overview Use this command to specify the interval between IPv6 Router Advertisements (RA) transmissions.

Use **no** parameter with this command to reset the value to the default value (600 seconds).

Syntax `ipv6 nd ra-interval <seconds>`
`no ipv6 nd ra-interval`

Parameter	Description
<code><seconds></code>	Specifies the number of seconds between IPv6 Router Advertisements (RAs). Valid values are from 4 to 1800 seconds.

Default 600 seconds.

Mode Interface Configuration for a VLAN interface, an Eth interface, an 802.1Q sub-interface, a local loopback interface, a PPP interface, a bridge, or a tunnel.

Usage notes To enable the transmission of router advertisements, you must apply the **no** version of the `ipv6 nd suppress-ra` command. This step is included in the example below.

Example To set the advertisements interval on eth1 to be 60 seconds, use the following commands:

```
awplus# configure terminal
awplus(config)# interface eth1
awplus(config-if)# ipv6 nd ra-interval 60
awplus(config-if)# no ipv6 nd suppress-ra
```

To reset the advertisements interval on eth1 to the default, use the following commands:

```
awplus# configure terminal
awplus(config)# interface eth1
awplus(config-if)# no ipv6 nd ra-interval
```

Related commands [ipv6 nd minimum-ra-interval](#)
[ipv6 nd suppress-ra](#)
[ipv6 nd prefix](#)

ipv6 nd ra-lifetime

Overview Use this command to specify the time period that this router can usefully act as a default gateway for the network. Each router advertisement resets this time period.

Use **no** parameter with this command to reset the value to default.

Syntax `ipv6 nd ra-lifetime <seconds>`
`no ipv6 nd ra-lifetime`

Parameter	Description
<code><seconds></code>	Time period in seconds. Valid values are from 0 to 9000. Note that you should set this time period to a value greater than the value you have set using the ipv6 nd ra-interval command.

Default 1800 seconds

Mode Interface Configuration for a VLAN interface, an Eth interface, an 802.1Q sub-interface, a local loopback interface, a PPP interface, a bridge, or a tunnel.

Usage notes This command specifies the lifetime of the current router to be announced in IPv6 Router Advertisements.

To enable the transmission of router advertisements, you must apply the **no** version of the [ipv6 nd suppress-ra](#) command. This step is included in the example below.

Examples To set the advertisement lifetime of 8000 seconds on eth1, use the following commands:

```
awplus# configure terminal
awplus(config)# interface eth1
awplus(config-if)# ipv6 nd ra-lifetime 8000
awplus(config-if)# no ipv6 nd suppress-ra
```

To reset the advertisement lifetime to the default on eth1, use the following commands:

```
awplus# configure terminal
awplus(config)# interface eth1
awplus(config-if)# no ipv6 nd ra-lifetime
```

To set the advertisement lifetime of 8000 seconds on the PPP interface ppp0, use the following commands:

```
awplus# configure terminal
awplus(config)# interface ppp0
awplus(config-if)# ipv6 nd ra-lifetime 8000
awplus(config-if)# no ipv6 nd suppress-ra
```

Related commands

- [ipv6 nd suppress-ra](#)
- [ipv6 nd prefix](#)

ipv6 nd reachable-time

Overview Use this command to specify the reachable time in the router advertisement to be used for detecting reachability of the IPv6 neighbor.

Use the **no** variant of this command to reset the value to default.

Syntax `ipv6 nd reachable-time <milliseconds>`
`no ipv6 nd reachable-time`

Parameter	Description
<code><milliseconds></code>	Time period in milliseconds. Valid values are from 1000 to 3600000. Setting this value to 0 indicates an unspecified reachable-time.

Default 0 milliseconds

Mode Interface Configuration for a VLAN interface, an Eth interface, an 802.1Q sub-interface, a local loopback interface, a PPP interface, a bridge, or a tunnel.

Usage notes This command specifies the reachable time of the current router to be announced in IPv6 Router Advertisements.

To enable the transmission of router advertisements, you must apply the **no ipv6 nd suppress-ra** command. This instruction is included in the example shown below.

Example To set the reachable-time in router advertisements on eth1 to be 1800000 milliseconds, enter the following commands:

```
awplus# configure terminal
awplus(config)# interface eth1
awplus(config-if)# ipv6 nd reachable-time 1800000
awplus(config-if)# no ipv6 nd suppress-ra
```

To reset the reachable-time in router advertisements on eth1 to an unspecified reachable-time (0 milliseconds), enter the following commands:

```
awplus# configure terminal
awplus(config)# interface eth1
awplus(config-if)# no ipv6 nd reachable-time
```

To set the reachable-time in router advertisements on the PPP interface ppp0 to be 1800000 milliseconds, enter the following commands:

```
awplus# configure terminal
awplus(config)# interface ppp0
awplus(config-if)# ipv6 nd reachable-time 1800000
awplus(config-if)# no ipv6 nd suppress-ra
```

To reset the reachable-time in router advertisements on the PPP interface ppp0 to an unspecified reachable-time (0 milliseconds), enter the following commands:

```
awplus# configure terminal
awplus(config)# interface ppp0
awplus(config-if)# no ipv6 nd reachable-time
```

Related commands

- [ipv6 nd suppress-ra](#)
- [ipv6 nd prefix](#)

ipv6 nd retransmission-time

Overview Use this command to specify the advertised retransmission interval for Neighbor Solicitation in milliseconds between IPv6 Routers.

Use the **no** variant of this command to reset the retransmission time to the default (1 second).

Syntax `ipv6 nd retransmission-time <milliseconds>`
`no ipv6 nd retransmission-time`

Parameter	Description
<code><milliseconds></code>	Time period in milliseconds. Valid values are from 1000 to 3600000.

Default 1000 milliseconds (1 second)

Mode Interface Configuration for a VLAN interface, an Eth interface, an 802.1Q sub-interface, a local loopback interface, a PPP interface, a bridge, or a tunnel.

Examples To set the retransmission-time of Neighbor Solicitation on eth1 to be 800000 milliseconds, enter the following commands:

```
awplus# configure terminal
awplus(config)# interface eth1
awplus(config-if)# ipv6 nd retransmission-time 800000
```

To reset the retransmission-time of Neighbor Solicitation on eth1 to the default 1000 milliseconds (1 second), enter the following commands:

```
awplus# configure terminal
awplus(config)# interface eth1
awplus(config-if)# no ipv6 nd retransmission-time
```

To set the retransmission-time of Neighbor Solicitation on the PPP interface ppp0 to be 800000 milliseconds, enter the following commands:

```
awplus# configure terminal
awplus(config)# interface ppp0
awplus(config-if)# ipv6 nd retransmission-time 800000
```

To reset the retransmission-time of Neighbor Solicitation on the PPP interface ppp0 to the default 1000 milliseconds (1 second), enter the following commands:

```
awplus# configure terminal
awplus(config)# interface ppp0
awplus(config-if)# no ipv6 nd retransmission-time
```

**Related
commands** [ipv6 nd suppress-ra](#)
[ipv6 nd prefix](#)

ipv6 nd route-information

Overview Use this command to supply more specific route information to be included in the RA (Router Advertisement) the device sends to downstream devices on the same link/LAN.

Use the **no** variant of this command to remove some or all route information.

Syntax

```
ipv6 nd route-information <ipv6-prefix/length>
[<0-4294967295>|infinity|default] [low|medium|high]

ipv6 nd route-information <ipv6-prefix/length>

no ipv6 nd route-information <ipv6-prefix/length>

no ipv6 nd route-information all
```

Parameter	Description
<ipv6-prefix/length>	The IPv6 network prefix and prefix length entered in dotted decimal format for the IPv6 network prefix, then slash notation for the IPv6 prefix length in the format X:X::X/M, e.g. 2001:db8::/64
<0-4294967295> infinity default	The length of time in seconds (relative to the time the packet is sent) that the prefix is valid for route determination. <ul style="list-style-type: none">infinity - specifies that the route advertisement has an infinite lifetime.default - is 3 * MaxRtrAdvInterval
low medium high	The preference value for the route information

Default No route information option is included in router advertisement on any interface.

Mode Interface Configuration for a VLAN interface, an Eth interface, an 802.1Q sub-interface, a local loopback interface, a PPP interface, a bridge, or a tunnel.

Example To configure a route of 2001:DB8:1::/48 on vlan2, with a lifetime of 6000 seconds and a high preference, use the commands:

```
awplus# configure terminal
awplus(config)# int vlan2
awplus(config-if)# ipv6 nd route-information 2001:DB8:1::/48
6000 high
```

Related commands [ipv6 nd suppress-ra](#)

Command changes Version 5.5.0-2.4: command added

ipv6 nd router-preference

Overview Use this command to set the default router preference in the router advertisements sent on a particular interface. You can use this setting to decide whether devices will use this router instead of an alternative router, by giving this router and the alternative router different values.

Use the **no** variant of this command to return the router preference to its default value.

Syntax `ipv6 nd router-preference {low|medium|high}`
`no ipv6 nd router-preference`

Parameter	Description
low	(0b11) Preference for this router on this interface is low.
medium	(0b00) Preference for this router on this interface is medium.
high	(0b01) Preference for this router on this interface is high.

Default Medium

Mode Interface Configuration for a VLAN interface, an Eth interface, an 802.1Q sub-interface, a local loopback interface, a PPP interface, a bridge, or a tunnel.

Example To set the router preference to high on eth1, use the commands:

```
awplus# configure terminal
awplus(config)# interface eth1
awplus(config-if)# ipv6 nd router-preference high
```

Related commands [ipv6 nd suppress-ra](#)
[show ipv6 interface](#)

Command changes Version 5.5.1-0.1: command added

ipv6 nd suppress-ra

Overview Use this command to inhibit IPv6 Router Advertisement (RA) transmission for the current interface. Router advertisements are used when applying IPv6 stateless auto-configuration.

Use the **no** parameter with this command to enable Router Advertisement transmission.

Syntax `ipv6 nd suppress-ra`
`no ipv6 nd suppress-ra`

Default Router Advertisement (RA) transmission is suppressed by default.

Mode Interface Configuration for a VLAN interface, an Eth interface, an 802.1Q sub-interface, a local loopback interface, a PPP interface, a bridge, or a tunnel.

Example To enable the transmission of router advertisements from vlan2 on the device, use the following commands:

```
awplus# configure terminal
awplus(config)# interface vlan2
awplus(config-if)# no ipv6 nd suppress-ra
```

To enable the transmission of router advertisements from ppp0 on the router, use the following commands:

```
awplus# configure terminal
awplus(config)# interface ppp0
awplus(config-if)# no ipv6 nd suppress-ra
```

Related commands [ipv6 nd ra-interval](#)
[ipv6 nd router-preference](#)
[ipv6 nd prefix](#)

ipv6 neighbor

Overview Use this command to add a static IPv6 neighbor entry.
Use the **no** variant of this command to remove a specific IPv6 neighbor entry.

Syntax `ipv6 neighbor <ipv6-address> <vlan-name> <mac-address>
<port-list>`
`no ipv6 neighbor <ipv6-address> <vlan-name> <port-list>`

Parameter	Description
<code><ipv6-address></code>	Specify the neighbor's IPv6 address in the format X:X::X:X.
<code><vlan-name></code>	Specify the neighbor's VLAN name.
<code><mac-address></code>	Specify the MAC hardware address in hexadecimal notation in the format HHHH.HHHH.HHHH.
<code><port-list></code>	Specify the port number, or port range.

Mode Global Configuration

Usage notes Use this command to clear a specific IPv6 neighbor entry. To clear all dynamic address entries, use the [clear ipv6 neighbors](#) command.

Example To create a static neighbor entry for IPv6 address 2001:0db8::a2, on vlan2, with MAC address 0000.cd28.0880, on port1.0.1, use the command:

```
awplus# configure terminal
awplus(config)# ipv6 neighbor 2001:0db8::a2 vlan2
0000.cd28.0880 port1.0.1
```

Related commands [clear ipv6 neighbors](#)
[show ipv6 neighbors](#)

ipv6 opportunistic-nd

Overview Use this command to enable opportunistic neighbor discovery for the global IPv6 ND cache. Opportunistic neighbor discovery changes the behavior for unsolicited ICMPv6 ND packet forwarding on the device.

Use the **no** variant of this command to disable opportunistic neighbor discovery for the global IPv6 ND cache.

Syntax `ipv6 opportunistic-nd`
`no ipv6 opportunistic-nd`

Default Opportunistic neighbor discovery is disabled by default.

Mode Global Configuration

Usage notes When opportunistic neighbor discovery is enabled, the device will reply to any received unsolicited ICMPv6 ND packets. The source MAC address for the unsolicited ICMPv6 ND packet is added to the IPv6 ND cache, so the device forwards the ICMPv6 ND packet. When opportunistic neighbor discovery is disabled, the source MAC address for the ICMPv6 packet is not added to the IPv6 ND cache, so the ICMPv6 ND packet is not forwarded by the device.

Examples To enable opportunistic neighbor discovery for the IPv6 ND cache, enter:

```
awplus# configure terminal
awplus(config)# ipv6 opportunistic-nd
```

To disable opportunistic neighbor discovery for the IPv6 ND cache, enter:

```
awplus# configure terminal
awplus(config)# no ipv6 opportunistic-nd
```

Related commands [arp opportunistic-nd](#)
[show ipv6 neighbors](#)
[show running-config interface](#)

ipv6 route

Overview This command adds a static IPv6 route to the Routing Information Base (RIB). If this route is the best route for the destination, then your device adds it to the Forwarding Information Base (FIB). Your device uses the FIB to forward packets and to advertise routes to neighbors.

The **no** variant of this command removes the static route.

Syntax `ipv6 route <dest-prefix/length> {<gateway-ip>|<gateway-name>} [<src-prefix/length>] [<distvalue>] [description <description>]`

`no ipv6 route <dest-prefix/length> {<gateway-ip>|<gateway-name>} [<src-prefix/length>] [<distvalue>]`

Parameter	Description
<i><dest-prefix/length></i>	Specifies the destination prefix. The IPv6 address prefix uses the format X:X::/prefix-length. The prefix-length is usually set between 0 and 64.
<i><gateway-ip></i>	Specifies the address of the gateway (or next hop). The IPv6 address uses the format X:X::X:X/Prefix-Length. The prefix-length is usually set between 0 and 64.
<i><gateway-name></i>	Specifies the name of the interface for the gateway (or next hop).
<i><src-prefix/length></i>	Specifies the source prefix. This is used for SADR - see the Usage notes. The IPv6 address prefix uses the format X:X::/prefix-length. The prefix-length is usually set between 0 and 64.
<i><distvalue></i>	Specifies the administrative distance for the route. Valid values are from 1 to 255. You can use administrative distance to determine which routes take priority over other routes. The route with the lowest distance value is used.
<i>description</i> <i><description></i>	A description to record the route's purpose. It can be up to 80 printable ASCII characters long, including spaces. The description does not affect routing or forwarding decisions made by the device. To see the description, use the command show running-configuration .

Mode Global Configuration

Usage notes You can configure IPv6 static routes for Source Address Dependent Routing (SADR) by providing a source prefix. In 'normal' routing, when the device searches

routes for a next hop to forward a packet to, the device chooses the next hop based only on the destination address of the packet. When you provide SADR information for a route, the device also inspects the source address and ensures it fits within the source prefix range you provided for this route.

Versions of AlliedWare Plus earlier than 5.5.1-2.1 do not support descriptions on static routes, so a start-up configuration that contains descriptions will be rejected by these older versions. If you add descriptions, be careful if you downgrade to an older AlliedWare Plus version.

Example To create a route with administrative distance of 32 to send packets to 2001:0db8::1/128 via eth1.1, use the commands:

```
awplus# configure terminal
awplus(config)# ipv6 route 2001:0db8::1/128 eth1.1 32
```

To use SADR to create a route for packets from 2001::/64 to 2223::/64, with a next hop of 2001::1, use the commands:

```
awplus# configure terminal
awplus(config)# ipv6 route 2223::/64 2001::1 2001::/64
```

To give a route a description of 'test' when creating it, use the commands:

```
awplus# configure terminal
awplus(config)# ipv6 route 2001:0db8::1/128 eth1.1 description
test
```

To remove the description from a route, re-enter the route without specifying the **description** parameter:

```
awplus# configure terminal
awplus(config)# ipv6 route 2001:0db8::1/128 eth1.1
```

**Related
Commands** [ipv6 multihoming](#)
[show running-config](#)
[show ipv6 route](#)

**Command
changes** Version 5.5.1-2.1: **description** parameter added
Version 5.5.0-0.3: **src-prefix** parameter added

ipv6 unreachable

Overview Use this command to enable ICMPv6 (Internet Control Message Protocol version 6) type 1, destination unreachable, messages.

Use the **no** variant of this command to disable destination unreachable messages. This prevents an attacker from using these messages to discover the topology of a network.

Syntax `ipv6 unreachable`
`no ipv6 unreachable`

Default Destination unreachable messages are enabled by default.

Mode Global Configuration

Usage notes When a device receives a packet for a destination that is unreachable it returns an ICMPv6 type 1 message. This message includes a reason code, as per the table below. An attacker can use these messages to obtain information regarding the topology of a network. Disabling destination unreachable messages, using the **no ipv6 unreachable** command, secures your network against this type of probing.

NOTE: *Disabling ICMPv6 destination unreachable messages breaks applications such as traceroute, which depend on these messages to operate correctly.*

Table 23-1: ICMPv6 type 1 reason codes and description

Code	Description [RFC]
0	No route to destination [RFC4443]
1	Communication with destination administratively prohibited [RFC4443]
2	Beyond scope of source address [RFC4443]
3	Address unreachable [RF4443]
4	Port unreachable [RFC4443]
5	Source address failed ingress/egress policy [RFC4443]
6	Reject route to destination [RFC4443]
7	Error in Source Routing Header [RFC6554]

Example To disable destination unreachable messages, use the commands

```
awplus# configure terminal
awplus(config)# no ipv6 unreachable
```

To enable destination unreachable messages, use the commands

```
awplus# configure terminal
awplus(config)# ipv6 unreachable
```

optimistic-nd

Overview Use this command to enable the optimistic neighbor discovery feature for both IPv4 and IPv6.

Use the **no** variant of this command to disable the optimistic neighbor discovery feature.

Syntax `optimistic-nd`
`no optimistic-nd`

Default The optimistic neighbor discovery feature is enabled by default.

Mode Interface Configuration for a VLAN interface.

Usage notes The optimistic neighbor discovery feature allows the device, after learning an IPv4 or IPv6 neighbor, to refresh the neighbor before it is deleted from the ARP or neighbor tables. The optimistic neighbor discovery feature enables the device to sustain L3 traffic switching to a neighbor without interruption.

If a neighbor receiving optimistic neighbor solicitations does not answer optimistic neighbor solicitations with neighbor advertisements, then the device puts the neighbor entry into the 'stale' state, and subsequently deletes it from the L3 switching tables.

Examples To enable the optimistic neighbor discovery feature on vlan2, use the following commands:

```
awplus# configure terminal
awplus(config)# interface vlan2
awplus(config-if)# optimistic-nd
```

To disable the optimistic neighbor discovery feature on vlan2, use the following commands:

```
awplus# configure terminal
awplus(config)# interface vlan2
awplus(config-if)# no optimistic-nd
```

Related commands [show running-config](#)

ping ipv6

Overview This command sends a query to another IPv6 host (send Echo Request messages).

Syntax `ping ipv6 {<host>|<ipv6-address>} [repeat {<1-2147483647>|continuous}] [size <10-1452>] [interface <interface-list>] [timeout <1-65535>]`

Parameter	Description
<code><ipv6-addr></code>	The destination IPv6 address. The IPv6 address uses the format X:X::X:X.
<code><hostname></code>	The destination hostname.
<code>repeat</code>	Specify the number of ping packets to send.
<code><1-2147483647></code>	Specify repeat count. The default is 5.
<code>size <10-1452></code>	The number of data bytes to send, excluding the 8 byte ICMP header. The default is 56 (64 ICMP data bytes).
<code>interface <interface-list></code>	<p>The interface or range of configured IP interfaces to use as the source in the IP header of the ping packet. The interface can be one of:</p> <ul style="list-style-type: none"> • a PPP interface (e.g. ppp0) • an Eth interface (e.g. eth1) • an 802.1Q Ethernet sub-interface (e.g. eth1.10, where '10' is the VLAN ID specified by the encapsulation dot1q command) • a VLAN (e.g. vlan2) • a bridge interface (e.g. br0) • a tunnel interface (e.g. tunnel0) • a WWAN interface (e.g. wwan0) • the loopback interface (lo) • a continuous range of interfaces, separated by a hyphen (e.g. ppp2-4) • a comma-separated list (e.g. ppp0,ppp2-4). Do not mix interface types in a list. <p>You can only specify the interface when pinging a link local address.</p>
<code>timeout <1-65535></code>	The time in seconds to wait for echo replies if the ARP entry is present, before reporting that no reply was received. If no ARP entry is present, it does not wait.
<code>repeat</code>	Specify the number of ping packets to send.
<code><1-2147483647></code>	Specify repeat count. The default is 5.
<code>continuous</code>	Continuous ping.

Parameter	Description
size <10-1452>	The number of data bytes to send, excluding the 8 byte ICMP header. The default is 56 (64 ICMP data bytes).
timeout <1-65535>	The time in seconds to wait for echo replies if the ARP entry is present, before reporting that no reply was received. If no ARP entry is present, it does not wait.

Mode User Exec and Privileged Exec

Example awplus# ping ipv6 2001:0db8::a2

Related commands [traceroute ipv6](#)

show ipv6 forwarding

Overview Use this command to display IPv6 forwarding status.

Syntax `show ipv6 forwarding`

Mode User Exec and Privileged Exec

Example `awplus# show ipv6 forwarding`

Output Figure 23-1: Example output from the **show ipv6 forwarding** command

```
awplus#show ipv6 forwarding
ipv6 forwarding is on
```

show ipv6 interface

Overview Use this command to display brief information about interfaces and the IPv6 address assigned to them.

Syntax `show ipv6 interface [brief|<interface-list>] [nd]`

Parameter	Description
brief	Specify this optional parameter to display brief IPv6 interface information.
<interface-list>	The interfaces to display information about. An interface-list can be: <ul style="list-style-type: none">• a PPP interface (e.g. ppp0)• an Eth interface (e.g. eth1)• an 802.1Q Ethernet sub-interface (e.g. eth1.10, where '10' is the VLAN ID specified by the encapsulation dot1q command)• a VLAN (e.g. vlan2)• a bridge interface (e.g. br0)• a tunnel interface (e.g. tunnel0)• a WWAN interface (e.g. wwan0)• the loopback interface (lo)• a continuous range of interfaces, separated by a hyphen (e.g. ppp2-4)• a comma-separated list (e.g. ppp0,ppp2-4). Do not mix interface types in a list. The specified interfaces must exist.
nd	Specify this optional parameter for Neighbor Discovery configurations.

Mode User Exec and Privileged Exec

Examples To display a brief list of all interfaces on a device, use the following command:

```
awplus# show ipv6 interface brief
```

Output Figure 23-2: Example output from the **show ipv6 interface brief** command

```
awplus#show ipv6 interface brief
```

Interface	IPv6-Address	Status	Protocol
eth1	unassigned	admin up	running
eth1.1	2001:db8::1/48 fe80::215:77ff:fee9:5c50/64	admin up	down
lo	unassigned	admin up	running

**Related
commands** [ipv6 nd router-preference](#)
[show interface brief](#)

show ipv6 neighbors

Overview Use this command to display all IPv6 neighbors.

For information on filtering and saving command output, see the [“Getting_Started with AlliedWare Plus” Feature Overview and Configuration_Guide](#).

Syntax `show ipv6 neighbors`

Mode User Exec and Privileged Exec

Example To display a device’s IPv6 neighbors, use the following command:

```
awplus# show ipv6 neighbors
```

Output Figure 23-3: Example output of the **show ipv6 neighbors** command

IPv6 Address	MAC Address	Interface	Port	Type
fe80::290:bff:fe3e:44dc	0090.0b3e.44dc	eth1	-	dynamic
fd32:b1f0:df7:ab03::1	0090.0b3e.44dc	eth1	-	dynamic
...				

Related commands [clear ipv6 neighbors](#)
[ipv6 neighbor](#)

show ipv6 route

Overview Use this command to display the IPv6 routing table for a protocol or from a particular table.

For information on filtering and saving command output, see the [“Getting Started with AlliedWare Plus” Feature Overview and Configuration Guide](#).

Syntax `show ipv6 route`
`[bgp|connected|database|ospf|rip|static|summary|<ipv6-address>`
`|<ipv6-prefix/prefix-length>]`

Parameter	Description
bgp	Displays only the routes learned from BGP.
connected	Displays only the routes learned from connected interfaces.
database	Displays only the IPv6 routing information extracted from the database.
ospf	Displays only the routes learned from OSPFv3.
rip	Displays only the routes learned from RIPng.
static	Displays only the IPv6 static routes you have configured.
summary	Displays summary information from the IPv6 routing table.
<ipv6-address>	Displays the routes for the specified address in the IPv6 routing table.
<ipv6-prefix>/<prefix-length>	Displays only the routes for the specified IPv6 prefix.

Mode User Exec and Privileged Exec

Example To display all IPv6 routes with all parameters turned on, use the following command:

```
awplus# show ipv6 route
```

To display all database entries for all IPv6 routes, use the following command:

```
awplus# show ipv6 route database
```

Output Figure 23-4: Example output of the **show ipv6 route** command

```
IPv6 Routing Table
Codes: C - connected, S - static, R - RIP, O - OSPF, B - BGP
S   ::/0 [1/0] via 2001::a:0:0:c0a8:a6, eth1
C   2001:db8::a:0:0:0/64 via ::, eth1
...
```

Output Figure 23-5: Example output of the **show ipv6 route database** command

```
IPv6 Routing Table
Codes: C - connected, S - static, R - RIP, O - OSPF, B - BGP
> - selected route, * - FIB route, p - stale info
Timers: Uptime

S   ::/0 [1/0] via 2001::a:0:0:c0a8:a01 inactive, 6d22h12m
      [1/0] via 2001::fa:0:0:c0a8:fa01 inactive, 6d22h12m
```

show ipv6 route summary

Overview Use this command to display the summary of the current NSM RIB entries.
For information on filtering and saving command output, see the [“Getting Started with AlliedWare Plus” Feature Overview and Configuration Guide](#).

Syntax `show ipv6 route summary`

Mode User Exec and Privileged Exec

Example To display IP route summary, use the following command:

```
awplus# show ipv6 route summary
```

Output Figure 23-6: Example output from the **show ipv6 route summary** command

```
IPv6 routing table name is Default-IPv6-Routing-Table(0)
IPv6 routing table maximum-paths is 4
RouteSource      Networks
connected        4
rip               5
Total            9
FIB              5
```

Related commands [show ip route database](#)

traceroute ipv6

Overview Use this command to trace the route to the specified IPv6 host.

Syntax `traceroute ipv6 {<ipv6-addr>|<hostname>}`

Parameter	Description
<code><ipv6-addr></code>	The destination IPv6 address. The IPv6 address uses the format X:X::X:X.
<code><hostname></code>	The destination hostname.

Mode User Exec and Privileged Exec

Example To run a traceroute for the IPv6 address 2001:0db8::a2, use the following command:

```
awplus# traceroute ipv6 2001:0db8::a2
```

Related commands [ping ipv6](#)

24

Routing Commands

Introduction

Overview This chapter provides an alphabetical reference of routing commands that are common across the routing IP protocols. For more information, see the [Route Selection Feature Overview and Configuration Guide](#).

- Command List**
- “[ip route](#)” on page 923
 - “[ipv6 route](#)” on page 926
 - “[max-fib-routes](#)” on page 928
 - “[max-static-routes](#)” on page 930
 - “[maximum-paths](#)” on page 931
 - “[show ip route](#)” on page 932
 - “[show ip route database](#)” on page 935
 - “[show ip route summary](#)” on page 938
 - “[show ipv6 route](#)” on page 940
 - “[show ipv6 route summary](#)” on page 942

ip route

Overview This command adds a static route to the Routing Information Base (RIB). If this route is the best route for the destination, then your device adds it to the Forwarding Information Base (FIB). Your device uses the FIB to advertise routes to neighbors and forward packets.

The **no** variant of this command removes the static route from the RIB and FIB.

Syntax

```
ip route <subnet&mask> {<gateway-ip>|<interface>} [<distance>]
[weight <1-255>] [description <description>]

no ip route <subnet&mask> {<gateway-ip>|<interface>}
[<distance>] [weight <1-255>]
```

Parameter	Description
<subnet&mask>	The IPv4 address of the destination subnet defined using either a prefix length or a separate mask specified in one of the following formats: <ul style="list-style-type: none"> The IPv4 subnet address in dotted decimal notation followed by the subnet mask, also in dotted decimal notation. The IPv4 subnet address in dotted decimal notation, followed by a forward slash, then the prefix length.
<gateway-ip>	The IPv4 address of the gateway device.
<interface>	The interface that connects your device to the network. For a VLAN, enter the name of the VLAN or its VID. You can also enter 'null' as an interface. Specify a 'null' interface to add a null or blackhole route to the switch. The gateway IP address or the interface is required if VRF-lite is not configured. If VRF-lite is configured: When adding a static intra-VRF route, you must specify either the gateway IP address or the interface. When adding a static inter-VRF route, you must specify both the gateway IP address and the interface.
<distance>	The administrative distance for the static route in the range 1 to 255. Static routes by default have an administrative distance of 1, which gives them the highest priority possible.
weight <1-255>	Weight is used for the Weighted Lottery Load Balancing mode. See the Usage notes section for more information.
description <description>	A description to record the route's purpose. It can be up to 80 printable ASCII characters long, including spaces. The description does not affect routing or forwarding decisions made by the device. To see the description, use the command show running-configuration .

Mode Global Configuration

Default The default administrative distance for a static route is 1.

Usage notes You can use administrative distance to determine which routes take priority over other routes.

Specify a 'Null' interface to add a null or blackhole route to the switch. A null or blackhole route is a routing table entry that does not forward packets, so any packets sent to it are dropped.

Versions of AlliedWare Plus earlier than 5.5.1-2.1 do not support descriptions on static routes, so a start-up configuration that contains descriptions will be rejected by these older versions. If you add descriptions, be careful if you downgrade to an older AlliedWare Plus version.

The **weight** parameter lets you assign a weight to the interface. AlliedWare Plus distributes the work load based on the number of sessions that are connected through the interfaces. It uses the weight that you assign to each interface to calculate a percentage of the total sessions that are allowed to connect through each interface. It then distributes the number of sessions between the interfaces accordingly.

Examples To add the destination 192.168.3.0 with the mask 255.255.255.0 as a static route available through the device at 10.10.0.2 with the default administrative distance, use the commands:

```
awplus# configure terminal
awplus(config)# ip route 192.168.3.0 255.255.255.0 10.10.0.2
```

To remove the destination 192.168.3.0 with the mask 255.255.255.0 as a static route available through the device at 10.10.0.2 with the default administrative distance, use the commands:

```
awplus# configure terminal
awplus(config)# no ip route 192.168.3.0 255.255.255.0 10.10.0.2
```

To specify a null or blackhole route 192.168.4.0/24, so packets forwarded to this route are dropped, use the commands:

```
awplus# configure terminal
awplus(config)# ip route 192.168.4.0/24 null
```

To add the destination 192.168.3.0 with the mask 255.255.255.0 as a static route available through the device at 10.10.0.2 with an administrative distance of 128, use the commands:

```
awplus# configure terminal
awplus(config)# ip route 192.168.3.0 255.255.255.0 10.10.0.2
128
```

To add the destination 192.168.3.0 with the mask 255.255.255.0 as a static route available through the device at 10.10.0.2 with the default administrative distance, and a weight of 7, use the commands:

```
awplus# configure terminal
awplus(config)# ip route 192.168.3.0 255.255.255.0 10.10.0.2
weight 7
```

To give a route a description of 'test' when creating it, use the commands:

```
awplus# configure terminal
awplus(config)# ip route 192.168.3.0/24 10.10.0.2 description
test
```

To remove the description from a route, re-enter the route without specifying the **description** parameter:

```
awplus# configure terminal
awplus(config)# ip route 192.168.3.0/24 10.10.0.2
```

**Related
commands**

[ip route vrf](#)
[show ip route](#)
[show ip route database](#)

**Command
changes**

Version 5.5.1-2.1: **weight** and **description** parameters added.

ipv6 route

Overview This command adds a static IPv6 route to the Routing Information Base (RIB). If this route is the best route for the destination, then your device adds it to the Forwarding Information Base (FIB). Your device uses the FIB to forward packets and to advertise routes to neighbors.

The **no** variant of this command removes the static route.

Syntax `ipv6 route <dest-prefix/length> {<gateway-ip>|<gateway-name>} [<src-prefix/length>] [<distvalue>] [description <description>]`

`no ipv6 route <dest-prefix/length> {<gateway-ip>|<gateway-name>} [<src-prefix/length>] [<distvalue>]`

Parameter	Description
<i><dest-prefix/length></i>	Specifies the destination prefix. The IPv6 address prefix uses the format X:X::/prefix-length. The prefix-length is usually set between 0 and 64.
<i><gateway-ip></i>	Specifies the address of the gateway (or next hop). The IPv6 address uses the format X:X::X:X/Prefix-Length. The prefix-length is usually set between 0 and 64.
<i><gateway-name></i>	Specifies the name of the interface for the gateway (or next hop).
<i><src-prefix/length></i>	Specifies the source prefix. This is used for SADR - see the Usage notes. The IPv6 address prefix uses the format X:X::/prefix-length. The prefix-length is usually set between 0 and 64.
<i><distvalue></i>	Specifies the administrative distance for the route. Valid values are from 1 to 255. You can use administrative distance to determine which routes take priority over other routes. The route with the lowest distance value is used.
<i>description</i> <i><description></i>	A description to record the route's purpose. It can be up to 80 printable ASCII characters long, including spaces. The description does not affect routing or forwarding decisions made by the device. To see the description, use the command show running-configuration .

Mode Global Configuration

Usage notes You can configure IPv6 static routes for Source Address Dependent Routing (SADR) by providing a source prefix. In 'normal' routing, when the device searches

routes for a next hop to forward a packet to, the device chooses the next hop based only on the destination address of the packet. When you provide SADR information for a route, the device also inspects the source address and ensures it fits within the source prefix range you provided for this route.

Versions of AlliedWare Plus earlier than 5.5.1-2.1 do not support descriptions on static routes, so a start-up configuration that contains descriptions will be rejected by these older versions. If you add descriptions, be careful if you downgrade to an older AlliedWare Plus version.

Example To create a route with administrative distance of 32 to send packets to 2001:0db8::1/128 via eth1.1, use the commands:

```
awplus# configure terminal
awplus(config)# ipv6 route 2001:0db8::1/128 eth1.1 32
```

To use SADR to create a route for packets from 2001::/64 to 2223::/64, with a next hop of 2001::1, use the commands:

```
awplus# configure terminal
awplus(config)# ipv6 route 2223::/64 2001::1 2001::/64
```

To give a route a description of 'test' when creating it, use the commands:

```
awplus# configure terminal
awplus(config)# ipv6 route 2001:0db8::1/128 eth1.1 description
test
```

To remove the description from a route, re-enter the route without specifying the **description** parameter:

```
awplus# configure terminal
awplus(config)# ipv6 route 2001:0db8::1/128 eth1.1
```

**Related
Commands** [ipv6 multihoming](#)
[show running-config](#)
[show ipv6 route](#)

**Command
changes** Version 5.5.1-2.1: **description** parameter added
Version 5.5.0-0.3: **src-prefix** parameter added

max-fib-routes

Overview This command enables you to control the maximum number of FIB routes configured. It operates by providing parameters that enable you to configure preset maximums and warning message thresholds.

NOTE: When using VRF-lite, this command applies to the Global VRF instance; to set the max-fib-routes for a user-defined VRF instance use the *max-fib-routes (VRF)* command. For static routes use the *max-static-routes* command for the Global VRF instance and the *max-static-routes (VRF)* command for a user-defined VRF instance.

Use the **no** variant of this command to set the maximum number of FIB routes to the default of 4294967294 FIB routes.

Syntax `max-fib-routes <1-4294967294> [<1-100>|warning-only]`
`no max-fib-routes`

Parameter	Description
max-fib-routes	This is the maximum number of routes that can be stored in the device's Forwarding Information dataBase. In practice, other practical system limits would prevent this maximum being reached.
<1-4294967294>	The allowable configurable range for setting the maximum number of FIB-routes.
<1-100>	This parameter enables you to optionally apply a percentage value. This percentage will be based on the maximum number of FIB routes you have specified. This will cause a warning message to appear when your routes reach your specified percentage value. Routes can continue to be added until your configured maximum value is reached.
warning-only	This parameter enables you to optionally apply a warning message. If you set this option a warning message will appear if your maximum configured value is reached. Routes can continue to be added until your device reaches either the maximum capacity value of 4294967294, or a practical system limit.

Default The default number of FIB routes is the maximum number of FIB routes (4294967294).

Mode Global Configuration

Examples To set the maximum number of dynamic routes to 2000 and warning threshold of 75%, use the following commands:

```
awplus# config terminal
awplus(config)# max-fib-routes 2000 75
```

**Related
commands** [max-fib-routes \(VRF\)](#)

max-static-routes

Overview Use this command to set the maximum number of static routes, excluding FIB (Forwarding Information Base) routes.

NOTE: For FIB routes use the [max-fib-routes](#) command.

Use the **no** variant of this command to set the maximum number of static routes to the default of 1024 static routes.

Syntax `max-static-routes <1-1024>`
`no max-static-routes`

Default The default number of static routes is the maximum number of static routes (1024).

Mode Global Configuration

Example To reset the maximum number of static routes to the default maximum, use the command:

```
awplus# configure terminal
awplus(config)# no max-static-routes
```

NOTE: Static routes are applied before adding routes to the RIB (Routing Information Base). Therefore, rejected static routes will not appear in the running config.

Related commands [max-fib-routes](#)

maximum-paths

Overview This command enables ECMP on your device, and sets the maximum number of paths that each route has in the Forwarding Information Base (FIB). ECMP is enabled by default.

The **no** variant of this command sets the maximum paths to the default of 4.

ECMP path calculations are flow-based. This means that packets from the same flow will always be sent on the same path.

Syntax `maximum-paths <1-8>`
`no maximum-paths`

Parameter	Description
<code><1-8></code>	The maximum number of paths that a route can have in the FIB.

Default By default the maximum number of paths is 4.

Mode Global Configuration

Examples To set the maximum number of paths for each route in the FIB to 5, use the command:

```
awplus# configure terminal
awplus(config)# maximum-paths 5
```

To set the maximum paths for a route to the default of 4, use the command:

```
awplus# configure terminal
awplus(config)# no maximum-paths
```

show ip route

Overview Use this command to display routing entries in the FIB (Forwarding Information Base). The FIB contains the best routes to a destination, and your device uses these routes when forwarding traffic. You can display a subset of the entries in the FIB based on protocol.

To modify the lines displayed, use the | (output modifier token); to save the output to a file, use the > output redirection token.

VRF-lite If VRF-lite is configured, you can display routing entries in the FIB associated with either the global routing domain or a named VRF.

Syntax `show ip route [bgp|connected|ospf|rip|static|
<ip-addr>|<ip-addr/prefix-length>]`

Syntax (VRF-lite) `show ip route {vrf <vrf-name>|global}
[bgp|connected|ospf|rip|static]`

Parameter	Description
global	If VRF-lite is configured, apply the command to the global routing and forwarding table.
vrf	Apply the command to the specified VRF instance.
<vrf-name>	The name of the VRF instance.
bgp	Displays only the routes learned from BGP.
connected	Displays only the routes learned from connected interfaces.
ospf	Displays only the routes learned from OSPF.
rip	Displays only the routes learned from RIP.
static	Displays only the static routes you have configured.
<ip-addr>	Displays the routes for the specified address. Enter an IPv4 address.
<ip-addr/prefix-length>	Displays the routes for the specified network. Enter an IPv4 address and prefix length.

Mode User Exec and Privileged Exec

Examples To display the static routes in the FIB, use the command:

```
awplus# show ip route static
```

To display the OSPF routes in the FIB, use the command:

```
awplus# show ip route ospf
```

Example (VRF-lite) To display all routing entries in the FIB associated with a VRF instance `red`, use the command:

```
awplus# show ip route vrf red
```

Output Each entry in the output from this command has a code preceding it, indicating the source of the routing entry. For example, O indicates OSPF as the origin of the route. The first few lines of the output list the possible codes that may be seen with the route entries.

Typically, route entries are composed of the following elements:

- code
- a second label indicating the sub-type of the route
- network or host IP address
- administrative distance and metric
- next hop IP address
- outgoing interface name
- time since route entry was added

Figure 24-1: Example output from the **show ip route** command

```
Codes: C - connected, S - static, R - RIP, B - BGP
O - OSPF, IA - OSPF inter area
N1 - OSPF NSSA external type 1, N2 - OSPF NSSA external type 2
E1 - OSPF external type 1, E2 - OSPF external type 2
* - candidate default

O    10.10.37.0/24 [110/11] via 10.10.31.16, vlan2, 00:20:54
C    3.3.3.0/24 is directly connected, vlan1
C    10.10.31.0/24 is directly connected, vlan2
C    10.70.0.0/24 is directly connected, vlan4
O E2 14.5.1.0/24 [110/20] via 10.10.31.16, vlan2, 00:18:56
C    33.33.33.33/32 is directly connected, lo
```

Connected Route An example of a connected route entry consists of:

```
C    10.10.31.0/24 is directly connected, eth1
```

This route entry denotes:

- Route entries for network 10.10.31.0/24 are derived from the IP address of local interface eth1.
- These routes are marked as Connected routes (C) and always preferred over routes for the same network learned from other routing protocols.

OSPF Route An example of an OSPF route entry consists of:

```
O    10.10.37.0/24 [110/11] via 10.10.31.16, eth1, 00:20:54
```

This route entry denotes:

- This route in the network 10.10.37.0/24 was added by OSPF.
- This route has an administrative distance of 110 and metric/cost of 11.
- This route is reachable via next hop 10.10.31.16.
- The outgoing local interface for this route is eth1.
- This route was added 20 minutes and 54 seconds ago.

OSPF External Route

An example of an OSPF external route entry consists of:

```
O E2 14.5.1.0/24 [110/20] via 10.10.31.16, eth1, 00:18:56
```

This route entry denotes that this route is the same as the other OSPF route explained above; the main difference is that it is a Type 2 External OSPF route.

Weight for Static Route

If the **weight** parameter has been set using the **ip route** command, it will be shown in the output:

```
S 10.10.37.0/24 [110/11] via 10.10.31.16, vlan2 weight 5  
via 10.10.31.32, vlan2 weight 1
```

AlliedWare Plus distributes the work load based on the number of sessions that are connected through the interfaces. It uses the weight that you assign to each interface to calculate a percentage of the total sessions that are allowed to connect through each interface. It then distributes the number of sessions between the interfaces accordingly.

Related commands

[ip route](#)
[ip route vrf](#)
[maximum-paths](#)
[show ip route database](#)

Command changes

Version 5.4.6-2.1: VRF-lite support added.

show ip route database

Overview This command displays the routing entries in the RIB (Routing Information Base).

When multiple entries are available for the same prefix, RIB uses the routes' administrative distances to choose the best route. All best routes are entered into the FIB (Forwarding Information Base). To view the routes in the FIB, use the [show ip route](#) command.

To modify the lines displayed, use the | (output modifier token); to save the output to a file, use the > (output redirection token).

Syntax `show ip route database [bgp|connected|ospf|rip|static]`

Syntax (VRF-lite) `show ip route [vrf <vrf-name>|global] database [bgp|connected|ospf|rip|static]`

Parameter	Description
global	If VRF-lite is configured, apply the command to the global routing and forwarding table.
vrf	Apply the command to the specified VRF instance.
<vrf-name>	The name of the VRF instance.
bgp	Displays only the routes learned from BGP.
connected	Displays only the routes learned from connected interfaces.
ospf	Displays only the routes learned from OSPF.
rip	Displays only the routes learned from RIP.
static	Displays only the static routes you have configured.

Mode User Exec and Privileged Exec

Example To display the static routes in the RIB, use the command:

```
awplus# show ip route database static
```

Output Figure 24-2: Example output from the **show ip route database** command:

```
Codes: C - connected, S - static, R - RIP, B - BGP
       O - OSPF, IA - OSPF inter area
       N1 - OSPF NSSA external type 1, N2 - OSPF NSSA external type 2
       E1 - OSPF external type 1, E2 - OSPF external type 2
       > - selected route, * - FIB route, p - stale info

O   *> 9.9.9.9/32 [110/31] via 10.10.31.16, vlan2, 00:19:21
O   10.10.31.0/24 [110/1] is directly connected, vlan2, 00:28:20
C   *> 10.10.31.0/24 is directly connected, vlan2
S   *> 10.10.34.0/24 [1/0] via 10.10.31.16, vlan2
O   10.10.34.0/24 [110/31] via 10.10.31.16, vlan2, 00:21:19
O   *> 10.10.37.0/24 [110/11] via 10.10.31.16, vlan2, 00:21:19
C   *> 10.30.0.0/24 is directly connected, vlan6
S   *> 11.22.11.0/24 [1/0] via 10.10.31.16, vlan2
O E2 *> 14.5.1.0/24 [110/20] via 10.10.31.16,vlan2, 00:19:21
O   16.16.16.16/32 [110/11] via 10.10.31.16, vlan2, 00:21:19
S   *> 16.16.16.16/32 [1/0] via 10.10.31.16, vlan2
O   *> 17.17.17.17/32 [110/31] via 10.10.31.16, vlan2, 00:21:19
C   *> 45.45.45.45/32 is directly connected, lo
O   *> 55.55.55.55/32 [110/21] via 10.10.31.16, vlan2, 00:21:19
C   *> 127.0.0.0/8 is directly connected, lo
```

Example (VRF-lite) To display all routing entries in the RIB associated with a VRF instance `red`, use the command:

```
awplus# show ip route vrf red database
```

Output Figure 24-3: Example output from the **show ip route vrf red database** command

```
[VRF: red]
Codes: C - connected, S - static, R - RIP, B - BGP
       O - OSPF, IA - OSPF inter area
       N1 - OSPF NSSA external type 1, N2 - OSPF NSSA external type 2
       E1 - OSPF external type 1, E2 - OSPF external type 2
       > - selected route, * - FIB route, p - stale info

O   192.168.10.0/24 [110/1] is directly connected, vlan1, 06:45:51
C   *> 192.168.10.0/24 is directly connected, vlan1
B   > 192.168.33.0/24 [20/0] via 192.168.30.3, 06:45:52
O E2 *> 192.168.110.0/24 [110/20] via 192.168.10.2, vlan1, 06:45:00
O E2 *> 192.168.111.0/24 [110/20] via 192.168.10.2, vlan1, 06:45:00
```

The routes added to the FIB are marked with a *. When multiple routes are available for the same prefix, the best route is indicated with the > symbol. All unselected routes have neither the * nor the > symbol.

```
S   *> 10.10.34.0/24 [1/0] via 10.10.31.16, vlan2
O   10.10.34.0/24 [110/31] via 10.10.31.16, vlan2, 00:21:19
```

These route entries denote:

- The same prefix was learned from OSPF and from static route configuration.

- Since this static route has a lower administrative distance than the OSPF route (110), the static route (1) is selected and installed in the FIB.

If the static route becomes unavailable, then the device automatically selects the OSPF route and installs it in the FIB.

Related commands [maximum-paths](#)
[show ip route](#)

Command changes Version 5.4.6-2.1: VRF-lite support added.

show ip route summary

Overview This command displays a summary of the current RIB (Routing Information Base) entries.

To modify the lines displayed, use the | (output modifier token); to save the output to a file, use the > output redirection token.

Syntax `show ip route summary`

Syntax (VRF-lite) `show ip route summary [vrf <vrf-name>|global]`

Parameter	Description
vrf	Specific VRF instance.
<vrf-name>	The name of the VRF instance.
global	The global routing and forwarding table.

Mode User Exec and Privileged Exec

Example To display a summary of the current RIB entries, use the command:

```
awplus# show ip route summary
```

Output Figure 24-4: Example output from the **show ip route summary** command

```
IP routing table name is Default-IP-Routing-Table(0)
IP routing table maximum-paths is 4
Route Source      Networks
connected         5
ospf               2
Total             8
```

Example (VRF-lite) To display a summary of the current RIB entries associated with a VRF instance red, use the command:

```
awplus# show ip route summary vrf red
```

Output Figure 24-5: Example output from the **show ip route summary vrf red** command

```
IP routing table name is Default-IP-Routing-Table(0)
IP routing table maximum-paths is 4
Route Source      Networks
connected         1
Total             1
FIB               0

[VRF: red]
Route Source      Networks
connected         1
ospf              2
Total             3
```

Related commands [show ip route](#)
[show ip route database](#)

Command changes Version 5.4.6-2.1: VRF-lite support added.

show ipv6 route

Overview Use this command to display the IPv6 routing table for a protocol or from a particular table.

For information on filtering and saving command output, see the [“Getting Started with AlliedWare Plus” Feature Overview and Configuration Guide](#).

Syntax `show ipv6 route`
`[bgp|connected|database|ospf|rip|static|summary|<ipv6-address>`
`|<ipv6-prefix/prefix-length>]`

Parameter	Description
bgp	Displays only the routes learned from BGP.
connected	Displays only the routes learned from connected interfaces.
database	Displays only the IPv6 routing information extracted from the database.
ospf	Displays only the routes learned from OSPFv3.
rip	Displays only the routes learned from RIPng.
static	Displays only the IPv6 static routes you have configured.
summary	Displays summary information from the IPv6 routing table.
<ipv6-address>	Displays the routes for the specified address in the IPv6 routing table.
<ipv6-prefix>/<prefix-length>	Displays only the routes for the specified IPv6 prefix.

Mode User Exec and Privileged Exec

Example To display all IPv6 routes with all parameters turned on, use the following command:

```
awplus# show ipv6 route
```

To display all database entries for all IPv6 routes, use the following command:

```
awplus# show ipv6 route database
```

Output Figure 24-6: Example output of the **show ipv6 route** command

```
IPv6 Routing Table
Codes: C - connected, S - static, R - RIP, O - OSPF, B - BGP
S   ::/0 [1/0] via 2001::a:0:0:c0a8:a6, eth1
C   2001:db8::a:0:0:0/64 via ::, eth1
...
```

Output Figure 24-7: Example output of the **show ipv6 route database** command

```
IPv6 Routing Table
Codes: C - connected, S - static, R - RIP, O - OSPF, B - BGP
> - selected route, * - FIB route, p - stale info
Timers: Uptime

S   ::/0 [1/0] via 2001::a:0:0:c0a8:a01 inactive, 6d22h12m
      [1/0] via 2001::fa:0:0:c0a8:fa01 inactive, 6d22h12m
```

show ipv6 route summary

Overview Use this command to display the summary of the current NSM RIB entries.
For information on filtering and saving command output, see the [“Getting Started with AlliedWare Plus” Feature Overview and Configuration Guide](#).

Syntax `show ipv6 route summary`

Mode User Exec and Privileged Exec

Example To display IP route summary, use the following command:

```
awplus# show ipv6 route summary
```

Output Figure 24-8: Example output from the **show ipv6 route summary** command

```
IPv6 routing table name is Default-IPv6-Routing-Table(0)
IPv6 routing table maximum-paths is 4
RouteSource      Networks
connected        4
rip              5
Total            9
FIB              5
```

Related commands [show ip route database](#)

25

RIP Commands

Introduction

Overview This chapter provides an alphabetical reference of commands used to configure RIP.

For information about configuring RIP, see the [RIP Feature Overview and Configuration Guide](#).

- Command List**
- ["accept-lifetime"](#) on page 945
 - ["address-family ipv4 \(RIP\)"](#) on page 947
 - ["alliedware-behavior"](#) on page 948
 - ["cisco-metric-behavior \(RIP\)"](#) on page 950
 - ["clear ip rip route"](#) on page 951
 - ["debug rip"](#) on page 953
 - ["default-information originate \(RIP\)"](#) on page 954
 - ["default-metric \(RIP\)"](#) on page 955
 - ["distance \(RIP\)"](#) on page 956
 - ["distribute-list \(RIP\)"](#) on page 957
 - ["fullupdate \(RIP\)"](#) on page 958
 - ["ip summary-address rip"](#) on page 959
 - ["ip prefix-list"](#) on page 960
 - ["ip rip authentication key-chain"](#) on page 962
 - ["ip rip authentication mode"](#) on page 964
 - ["ip rip authentication string"](#) on page 966
 - ["ip rip receive-packet"](#) on page 968
 - ["ip rip receive version"](#) on page 969

- ["ip rip send-packet"](#) on page 970
- ["ip rip send version"](#) on page 971
- ["ip rip send version 1-compatible"](#) on page 973
- ["ip rip split-horizon"](#) on page 974
- ["key"](#) on page 975
- ["key chain"](#) on page 976
- ["key-string"](#) on page 977
- ["maximum-prefix"](#) on page 978
- ["neighbor \(RIP\)"](#) on page 979
- ["network \(RIP\)"](#) on page 980
- ["passive-interface \(RIP\)"](#) on page 982
- ["recv-buffer-size \(RIP\)"](#) on page 983
- ["redistribute \(RIP\)"](#) on page 984
- ["restart rip graceful"](#) on page 986
- ["rip restart grace-period"](#) on page 987
- ["route \(RIP\)"](#) on page 988
- ["router rip"](#) on page 989
- ["send-lifetime"](#) on page 990
- ["show debugging rip"](#) on page 992
- ["show ip prefix-list"](#) on page 993
- ["show ip protocols rip"](#) on page 994
- ["show ip rip"](#) on page 995
- ["show ip rip database"](#) on page 996
- ["show ip rip interface"](#) on page 997
- ["show ip rip vrf database"](#) on page 998
- ["show ip rip vrf interface"](#) on page 999
- ["timers \(RIP\)"](#) on page 1000
- ["undebug rip"](#) on page 1002
- ["version \(RIP\)"](#) on page 1003

accept-lifetime

Overview Use this command to specify the time period during which the authentication key on a key chain is received as valid.

Use the **no** variant of this command to remove a specified time period for an authentication key on a key chain as set previously with the **accept-lifetime** command.

Syntax `accept-lifetime <start-date> {<end-date>|
duration <seconds>|infinite}`
`no accept-lifetime`

Parameter	Description
<code><start-date></code>	Specifies the start time and date in the format: <code><hh:mm:ss> <day> <month> <year></code> or <code><hh:mm:ss> <month> <day> <year></code> , where:
<code><hh:mm:ss></code>	The time of the day, in hours, minutes and seconds
<code><day></code>	<1-31> The day of the month
<code><month></code>	The month of the year (the first three letters of the month, for example, Jan)
<code><year></code>	<1993-2035> The year
<code><end-date></code>	Specifies the end time and date in the format: <code><hh:mm:ss> <day> <month> <year></code> or <code><hh:mm:ss> <month> <day> <year></code> , where:
<code><hh:mm:ss></code>	The time of the day, in hours, minutes and seconds
<code><day></code>	<1-31> The day of the month
<code><month></code>	The month of the year (the first three letters of the month, for example, Jan)
<code><year></code>	<1993-2035> The year
<code><seconds></code>	<1-2147483646> Duration of the key in seconds.
<code>infinite</code>	Never expires.

Mode Keychain-key Configuration

Examples The following examples show the setting of accept-lifetime for key 1 on the key chain named "mychain".

```
awplus# configure terminal
awplus(config)# key chain mychain
awplus(config-keychain)# key 1
awplus(config-keychain-key)# accept-lifetime 03:03:01 Sep 3
2016 04:04:02 Oct 6 2016
```

or:

```
awplus# configure terminal
awplus(config)# key chain mychain
awplus(config-keychain)# key 1
awplus(config-keychain-key)# accept-lifetime 03:03:01 3 Sep
2016 04:04:02 6 Oct 2016
```

**Related
commands**

[key](#)
[key-string](#)
[key chain](#)
[send-lifetime](#)

address-family ipv4 (RIP)

Overview This command enters the IPv4 address-family command mode. In this mode you can configure address-family specific parameters for a specific VRF (RIP) instance.

Syntax `address-family ipv4 vrf <vrf-name>`
`no address-family ipv4 vrf <vrf-name>`

Parameter	Description
<code>ipv4</code>	Configure parameters relating to the RIP exchange of IPv4 prefixes.
<code>vrf</code>	Apply this command to a VRF instance.
<code><vrf-name></code>	The name of the VRF instance.

Mode Router Configuration

Usage To leave Address Family mode and return to Router Configuration mode, use the [exit-address-family](#) command.

Example In this example the address family "green" is entered, and then exited by using the [exit-address-family](#) command.

```
awplus# configure terminal
awplus(config)# router rip
awplus(config-router)# address-family ipv4 vrf green
awplus(config-router-af)# exit-address-family
awplus(config-router)#
```

Related commands [exit-address-family](#)

Command changes Version 5.4.6-2.1: VRF-lite support added.

alliedware-behavior

Overview This command configures your device to exhibit AlliedWare behavior when sending RIPv1 response/update messages. Configuring for this behavior may be necessary if you are replacing an AlliedWare device with an AlliedWare Plus device and wish to ensure consistent RIPv1 behavior.

Use the **no** variant of this command to implement AlliedWare Plus behavior.

This command has no impact on devices running RIPv2. Reception and transmission can be independently altered to conform to AlliedWare standard.

Syntax `alliedware-behavior {rip1-send|rip1-recv}`
`no alliedware-behavior {rip1-send|rip1-recv}`

Parameter	Description
<code>rip1-send</code>	Configures the router to behave in AlliedWare mode when sending update messages.
<code>rip1-recv</code>	Configures the router to behave in AlliedWare mode when receiving update messages.

Default By default when sending out RIPv1 updates on an interface, if the prefix (learned through RIPv2 or otherwise redistributed into RIP) being advertised does not match the subnetting used on the outgoing RIPv1 interface it will be filtered. The **alliedware-behavior** command returns your router's RIPv1 behavior to the AlliedWare format, where the prefix will be advertised as-is.

For example, if a RIPv1 update is being sent over interface 192.168.1.4/26, by default the prefix 192.168.1.64/26 will be advertised, but the prefix 192.168.1.144/28 will be filtered because the mask /28 does not match the interface's mask of /26. If **alliedware-behavior rip1-send** is configured, 192.168.1.144 would be sent as-is.

Mode Router Configuration

Examples To configure your device for **AlliedWare**-like behavior when sending and receiving RIPv1 update messages, enter the commands:

```
awplus# configure terminal
awplus(config)# router rip
awplus(config-router)# alliedware-behavior rip1-send
awplus(config-router)# alliedware-behavior rip1-recv
```

To return your device to **AlliedWare Plus**-like behavior when sending and receiving RIPv1 update messages, enter the commands:

```
awplus# configure terminal
awplus(config)# router rip
awplus(config-router)# no alliedware-behavior rip1-send
awplus(config-router)# no alliedware-behavior rip1-recv
```

**Validation
Commands** [show ip protocols rip](#)
 [show running-config](#)

**Related
commands** [fullupdate \(RIP\)](#)

cisco-metric-behavior (RIP)

Overview Use this command to enable or disable the RIP routing metric update to conform to Cisco's implementation. This command is provided to allow inter-operation with older Cisco devices that do not conform to the RFC standard for RIP route metrics.

Use the **no** variant of this command to disable this feature.

Syntax `cisco-metric-behavior {enable|disable}`
`no cisco-metric-behavior`

Parameter	Description
enable	Enables updating the metric consistent with Cisco.
disable	Disables updating the metric consistent with Cisco.

Default By default, the Cisco metric-behavior is disabled.

Mode Router Configuration

Examples To enable the routing metric update to behave as per the Cisco implementation, enter the commands:

```
awplus# configure terminal
awplus(config)# router rip
awplus(config-router)# cisco-metric-behavior enable
```

To disable the routing metric update to behave as per the default setting, enter the commands:

```
awplus# configure terminal
awplus(config)# router rip
awplus(config-router)# no cisco-metric-behavior
```

Validation Commands `show running-config`

clear ip rip route

Overview Use this command to clear specific data from the RIP routing table.

Syntax `clear ip rip route <ip-dest-network/prefix-length>`
`clear ip rip route`
{static|connected|rip|ospf|bgp|invalid-routes|all}

Syntax (VRF-lite) `clear ip rip [vrf <vrf-name>] route`
`<ip-dest-network/prefix-length>`
`clear ip rip [vrf <vrf-name>] route`
{static|connected|rip|ospf|bgp|invalid-routes|all}

Parameter	Description
vrf	Apply this command to a VRF instance.
<vrf-name>	The name of the VRF instance.
<ip-dest-network/ prefix-length>	Removes entries which exactly match this destination address from RIP routing table. Enter the IP address and prefix length of the destination network.
static	Removes static entries from the RIP routing table.
connected	Removes entries for connected routes from the RIP routing table.
rip	Removes only RIP routes from the RIP routing table.
ospf	Removes only OSPF routes from the RIP routing table.
bgp	Removes only BGP routes from the RIP routing table.
invalid-routes	Removes routes with metric 16 immediately. Otherwise, these routes are not removed until RIP times out the route after 2 minutes.
all	Clears the entire RIP routing table.

Mode Privileged Exec

Usage notes Using this command with the **all** parameter clears the RIP table of all the routes.

Examples To clear the route 10.0.0.0/8 from the RIP routing table, use the following command:

```
awplus# clear ip rip route 10.0.0.0/8
```

Examples (VRF-lite) To clear RIP routes associated with the VRF instance 'red' for OSPF routes, use the following command:

```
awplus# clear ip rip vrf red route ospf
```

To clear the route 10.0.0.0/8 from the RIP routing table for the VRF instance 'red', use the following command:

```
awplus# clear ip rip vrf red route 10.0.0.0/8
```

Command changes Version 5.4.6-2.1: VRF-lite support added.

debug rip

Overview Use this command to specify the options for the displayed debugging information for RIP events and RIP packets.

Use the **no** variant of this command to disable the specified debug option.

Syntax `debug rip {events|nsm|<packet>|all}`
`no debug rip {events|nsm|<packet>|all}`

Parameter	Description
events	RIP events debug information is displayed.
nsm	RIP and NSM communication is displayed.
<packet>	packet [recv send] [detail] Specifies RIP packets only.
recv	Specifies that information for received packets be displayed.
send	Specifies that information for sent packets be displayed.
detail	Displays detailed information for the sent or received packet.
all	Displays all RIP debug information.

Default Disabled

Mode Privileged Exec and Global Configuration

Example The following example displays information about the RIP packets that are received and sent out from the device.

```
awplus# debug rip packet
```

Related commands [undebug rip](#)

default-information originate (RIP)

Overview Use this command to generate a default route into the Routing Information Protocol (RIP).

Use the **no** variant of this command to disable this feature.

Syntax `default-information originate`
`no default-information originate`

Default Disabled

Mode Router Configuration

Usage If routes are being redistributed into RIP and the router's route table contains a default route, within one of the route categories that are being redistributed, the RIP protocol will advertise this default route, irrespective of whether the **default-information originate** command has been configured or not. However, if the router has not redistributed any default route into RIP, but you want RIP to advertise a default route anyway, then use this command.

This will cause RIP to create a default route entry in the RIP database. The entry will be of type RS (Rip Static). Unless actively filtered out, this default route will be advertised out every interface that is sending RIP. Split horizon does not apply to this route, as it is internally generated. This operates quite similarly to the OSPF **default-information originate always** command.

Example `awplus# configure terminal`
`awplus(config)# router rip`
`awplus(config-router)# default-information originate`

default-metric (RIP)

Overview Use this command to specify the metrics to be assigned to redistributed RIP routes. Use the **no** variant of this command to reset the RIP metric back to its default (1).

Syntax `default-metric <metric>`
`no default-metric [<metric>]`

Parameter	Description
<metric>	<1-16> Specifies the value of the default metric.

Default By default, the RIP metric value is set to 1.

Mode RIP Router Configuration or RIP Router Address Family Configuration for a VRF instance.

Usage notes This command is used with the [redistribute \(RIP\)](#) command to make the routing protocol use the specified metric value for all redistributed routes, regardless of the original protocol that the route has been redistributed from.

Examples This example assigns the cost of 10 to the routes that are redistributed into RIP.

```
awplus# configure terminal
awplus(config)# router rip
awplus(config-router)# default-metric 10
awplus(config-router)# redistribute ospf
awplus(config-router)# redistribute connected
```

Example (VRF-lite) This example assigns the cost of 10 to the routes which are redistributed into RIP for the VRF instance blue.

```
awplus# configure terminal
awplus(config)# router rip
awplus(config-router)# address family ipv4 vrf blue
awplus(config-router-af)# default-metric 10
awplus(config-router-af)# redistribute ospf
awplus(config-router-af)# redistribute connected
```

Related commands [redistribute \(RIP\)](#)

Command changes Version 5.4.6-2.1: VRF-lite support added.

distance (RIP)

Overview This command sets the administrative distance for RIP routes. Your device uses this value to select between two or more routes to the same destination obtained from two different routing protocols. The route with the smallest administrative distance value is added to the Forwarding Information Base (FIB). For more information, see the [Route Selection Feature Overview and Configuration Guide](#).

The **no** variant of this command sets the administrative distance for the RIP route to the default of 120.

Syntax `distance <1-255> [<ip-addr/prefix-length>]`
`no distance [<1-255>] [<ip-addr/prefix-length>]`

Parameter	Description
<1-255>	The administrative distance value you are setting for this RIP route.
<ip-addr/prefix-length>	The network IP address and prefix-length that you are changing the administrative distance for.

Mode RIP Router Configuration or RIP Router Address Family Configuration for a VRF instance.

Examples To set the administrative distance to 8 for the RIP routes within the 10.0.0.0/8 network, use the commands:

```
awplus# configure terminal
awplus(config)# router rip
awplus(config-router)# distance 8 10.0.0.0/8
```

To set the administrative distance to the default of 120 for the RIP routes within the 10.0.0.0/8 network, use the commands:

```
awplus# configure terminal
awplus(config)# router rip
awplus(config-router)# no distance 8 10.0.0.0/8
```

Example (VRF-lite) This example assigns a cost of 10 to the routes for the VRF instance blue, when redistributed into RIP.

```
awplus# configure terminal
awplus(config)# router rip
awplus(config-router)# address family ipv4 blue
awplus(config-router-af)# distance 10
```

Command changes Version 5.4.6-2.1: VRF-lite support added.

distribute-list (RIP)

Overview Use this command to filter incoming or outgoing route updates using the prefix-list.

When running VRF-lite, this command can be applied to a specific VRF instance.

Use the **no** variant of this command to disable this feature.

Syntax `distribute-list prefix <prefix-list> {in|out} [<interface>]`
`no distribute-list prefix <prefix-list> {in|out} [<interface>]`

Parameter	Description
prefix	Filter prefixes in routing updates.
<prefix-list>	Specifies the name of the IPv4 prefix-list to use.
in	Filter incoming routing updates.
out	Filter outgoing routing updates.
<interface>	The interface on which the filtering applies.

Default Disabled

Mode RIP Router Configuration or RIP Router Address Family Configuration for a VRF instance.

Usage notes Filter out incoming or outgoing route updates using a prefix-list. If you do not specify the name of the interface, the filter will be applied to all interfaces.

Examples To apply a prefix list called 'myfilter' to filter incoming routing updates on eth1, use the commands:

```
awplus# configure terminal
awplus(config)# router rip
awplus(config-router)# distribute-list prefix myfilter in eth1
```

Example (VRF-lite) This example applies the commands of the previous prefix-list example, but to a specific VRF named blue:

```
awplus# configure terminal
awplus(config)# router rip
awplus(config-router)# address-family ipv4 vrf blue
awplus(config-router-af)# distribute-list prefix myfilter in
vlan2
```

Command changes Version 5.4.6-2.1: VRF-lite support added.

fullupdate (RIP)

Overview Use this command to specify which routes RIP should advertise when performing a triggered update. By default, when a triggered update is sent, RIP will only advertise those routes that have changed since the last update. When **fullupdate** is configured, the device advertises the full RIP route table in outgoing triggered updates, including routes that have not changed. This enables faster convergence times, or allows inter-operation with legacy network equipment, but at the expense of larger update messages.

Use the **no** variant of this command to disable this feature.

Syntax fullupdate
no fullupdate

Default By default this feature is disabled.

Mode RIP Router Configuration or RIP Router Address Family Configuration for a VRF instance.

Usage (VRF-lite) If VRF-lite is configured, you can apply this command for either the global routing environment, or to a specific VRF instance.

Example To enable the fullupdate (RIP) function, use the commands:

```
awplus# configure terminal
awplus(config)# router rip
awplus(config-router)# fullupdate
```

Example (VRF-lite) To enable the full update (RIP) function on the VRF instance named 'blue', use the commands:

```
awplus# configure terminal
awplus(config)# router rip
awplus(config-router)# address-family ipv4 vrf blue
awplus(config-router-af)# fullupdate
```

Command changes Version 5.4.6-2.1: VRF-lite support added.

ip summary-address rip

Overview Use this command to configure a summary IP address on a RIPv2 interface. Use the **no** variant of this command to remove a summary IP address from a selected RIPv2 interface.

Syntax `ip summary-address rip {<ip-address/prefix-length>}`
`no ip summary-address rip {<ip-address/prefix-length>}`

Parameter	Description
<code><ip-address/prefix-length></code>	The summary IPv4 address to be advertised

Mode Interface Configuration for a VLAN interface, an Eth interface, an 802.1Q sub-interface, a PPP interface, a bridge, or a tunnel.

Usage notes Route summarization is a technique that helps network administrators reduce the size of the routing tables by advertising a single super-network that covers a range of subnets.

You statically configure an IP summary address on a router interface. The router then advertises the summary address downstream through this interface. This means that:

- all the routers that are downstream from the configured interface will receive only the summary route, and none of the child routes via the RIP advertisement.
- As long as at least one of the child routes is valid, the router will propagate the summary route. But when the last child that is part of the summarized range disappears, then the router will stop advertising the summary route through the interface.

This command will be rejected if there is no IP address configured on the interface.

NOTE: Manual route summarization is not supported when the interface/router is running in RIPv1.

Example The subnets 10.4.1.0/24, 10.4.2.128/25 and 10.4.3.0/24 can be summarized and advertised as 10.4.0.0/16 on eth1 using the following commands:

```
awplus# configure terminal
awplus(config)# interface eth1
awplus(config-if)# ip summary-address rip 10.4.0.0/16
```

Related commands [show ip rip database](#)
[show ip protocols rip](#)

Command changes Version 5.4.8-0.2 command added

ip prefix-list

Overview Use this command to create an entry for an IPv4 prefix list.

Use the **no** variant of this command to delete the IPv4 prefix-list entry.

Syntax

```
ip prefix-list <list-name> [seq <1-429496725>] {deny|permit}
{any|<ip-prefix>} [ge <0-32>] [le <0-32>]

ip prefix-list <list-name> description <text>

ip prefix-list sequence-number

no ip prefix-list <list-name> [seq <1-429496725>]

no ip prefix-list <list-name> [description <text>]

no ip prefix-list sequence-number
```

Parameter	Description
<list-name>	Specifies the name of a prefix list.
seq <1-429496725>	Sequence number of the prefix list entry.
deny	Specifies that the prefixes are excluded from the list.
permit	Specifies that the prefixes are included in the list.
<ip-prefix>	Specifies the IPv4 address and length of the network mask in dotted decimal in the format A.B.C.D/M.
any	Any prefix match. Same as 0.0.0.0 le 32 .
ge<0-32>	Specifies the minimum prefix length to be matched.
le<0-32>	Specifies the maximum prefix length to be matched.
<text>	Text description of the prefix list.
sequence-number	Specify sequence numbers included or excluded in prefix list.

Mode Global Configuration

Usage notes When the device processes a prefix list, it starts to match prefixes from the top of the prefix list, and stops whenever a permit or deny occurs. To promote efficiency, use the **seq** parameter and place common permits or denials towards the top of the list. If you do not use the **seq** parameter, the sequence values are generated in a sequence of 5.

The parameters **ge** and **le** specify the range of the prefix lengths to be matched. When setting these parameters, set the **le** value to be less than 32, and the **ge** value to be less than or equal to the **le** value and greater than the ip-prefix mask length.

Prefix lists implicitly exclude prefixes that are not explicitly permitted in the prefix list. This means if a prefix that is being checked against the prefix list reaches the end of the prefix list without matching a permit or deny, this prefix will be denied.

Example In the following sample configuration, the last **ip prefix-list** command in the below list matches all, and the first **ip prefix-list** command denies the IP network 76.2.2.0:

```
awplus(config)# router bgp 100
awplus(config-router)# network 172.1.1.0
awplus(config-router)# network 172.1.2.0
awplus(config-router)# neighbor 10.6.5.3 remote-as 300
awplus(config-router)# neighbor 10.6.5.3 prefix-list mylist out
awplus(config-router)# exit
awplus(config)# ip prefix-list mylist seq 5 deny 76.2.2.0/24
awplus(config)# ip prefix-list mylist seq 100 permit any
```

To deny the IP addresses between 10.0.0.0/14 (10.0.0.0 255.252.0.0) and 10.0.0.0/22 (10.0.0.0 255.255.252.0) within the 10.0.0.0/8 (10.0.0.0 255.0.0.0) addressing range, enter the following commands:

```
awplus# configure terminal
awplus(config)# ip prefix-list mylist seq 12345 deny 10.0.0.0/8
ge 14 le 22
```

Related commands

- [neighbor prefix-list](#)
- [clear ip prefix-list](#)
- [show ip prefix-list](#)

ip rip authentication key-chain

Overview Use this command to enable RIPv2 authentication on an interface and specify the name of the key chain to be used.

Use the **no** variant of this command to disable this function.

Syntax `ip rip authentication key-chain <key-chain-name>`
`no ip rip authentication key-chain`

Parameter	Description
<code><key-chain-name></code>	Specify the name of the key chain. This is an alpha-numeric string, but it cannot include spaces.

Mode Interface Configuration for a VLAN interface, an Eth interface, an 802.1Q sub-interface, a PPP interface, a bridge, or a tunnel.

Usage notes Use this command to perform authentication on the interface. Not configuring the key chain results in no authentication at all.

The AlliedWare Plus™ implementation provides the choice of configuring authentication for single key or multiple keys at different times. Use the [ip rip authentication string](#) command for single key authentication. Use the [ip rip authentication key-chain](#) command for multiple keys authentication. See the [RIP Feature Overview and Configuration Guide](#) for illustrated RIP configuration examples.

For multiple key authentication, use the following steps to configure a route to enable RIPv2 authentication using multiple keys at different times:

- 1) Define a key chain with a key chain name, using the following commands:

```
awplus# configure terminal
awplus(config)# key chain <key-chain-name>
```

- 2) Define a key on this key chain, using the following command:

```
awplus(config-keychain)# key <keyid>
```

- 3) Define the password used by the key, using the following command:

```
awplus(config-keychain-key)# key-string <key-password>
```

- 4) Enable authentication on the desired interface and specify the key chain to be used, using the following commands:

```
awplus# configure terminal
awplus(config)# interface <id>
awplus(config-if)# ip rip authentication key-chain
<key-chain-name>
```

- 5) Specify the mode of authentication for the given interface (text or MD5), using the following command:

```
awplus(config-if)# ip rip authentication mode {md5|text}
```

Example 1 To use the key chain named 'mykey' on the interface eth1, use the commands:

```
awplus# configure terminal
awplus(config)# interface eth1
awplus(config-if)# ip rip authentication key-chain mykey
```

Example 2 In the following example of a configuration for multiple keys authentication, a password 'toyota' is set for key 1 in key chain 'cars'. Authentication is enabled on eth1 and the authentication mode is set to MD5:

```
awplus# configure terminal
awplus(config)# key chain cars
awplus(config-keychain)# key 1
awplus(config-keychain-key)# key-string toyota
awplus(config-keychain-key)# accept-lifetime 10:00:00 Oct 08
2021 duration 43200
awplus(config-keychain-key)# send-lifetime 10:00:00 Oct 08 2021
duration 43200
awplus(config-keychain-key)# exit
awplus(config-keychain)# exit
awplus(config)# interface eth1
awplus(config-if)# ip rip authentication key-chain cars
awplus(config-if)# ip rip authentication mode md5
```

**Related
commands**

[accept-lifetime](#)
[send-lifetime](#)
[ip rip authentication mode](#)
[ip rip authentication string](#)
[key](#)
[key chain](#)

ip rip authentication mode

Overview Use this command to specify the type of authentication mode used for RIP v2 packets.

Use the **no** variant of this command to restore clear text authentication.

Syntax

```
ip rip authentication mode {md5|text}
no ip rip authentication mode
```

Parameter	Description
md5	Uses the keyed MD5 authentication algorithm.
text	Specifies clear text or simple password authentication.

Default Text authentication is enabled

Mode Interface Configuration for a VLAN interface, an Eth interface, an 802.1Q sub-interface, a PPP interface, a bridge, or a tunnel.

Usage notes The AlliedWare Plus™ implementation provides the choice of configuring authentication for single key or multiple keys at different times. Use the [ip rip authentication string](#) command for single key authentication. Use the [ip rip authentication key-chain](#) command for multiple keys authentication. See the [RIP Feature Overview and Configuration Guide](#) for illustrated RIP configuration examples.

Usage: single key Use the following steps to configure a route to enable RIPv2 authentication using a single key or password:

- 1) Define the authentication string or password used by the key for the desired interface, using the following commands:

```
awplus# configure terminal
awplus(config)# interface <id>
awplus(config-if)# ip rip authentication string <auth-string>
```

- 2) Specify the mode of authentication for the given interface (text or MD5), using the following commands:

```
awplus# configure terminal
awplus(config)# interface <id>
awplus(config-if)# ip rip authentication mode {md5|text}
```

Usage: multiple key For multiple keys authentication, use the following steps to configure a route to enable RIPv2 authentication using multiple keys at different times:

- 1) Define a key chain with a key chain name, using the following commands:

```
awplus# configure terminal
awplus(config)# key chain <key-chain-name>
```

- 2) Define a key on this key chain using the following command:

```
awplus(config-keychain)# key <keyid>
```

- 3) Define the password used by the key, using the following command:

```
awplus(config-keychain-key)# key-string <key-password>
```

- 4) Enable authentication on the desired interface and specify the key chain to be used, using the following commands:

```
awplus(config-if)# ip rip authentication key-chain
<key-chain-name>
```

- 5) Specify the mode of authentication for the given interface (text or MD5), using the following commands:

```
awplus(config-if)# ip rip authentication mode {md5|text}
```

Example 1 To use MD5 authentication on the interface eth1, use the following commands:

```
awplus# configure terminal
awplus(config)# interface eth1
awplus(config-if)# ip rip authentication mode md5
```

Example 2 In the following example of a configuration for multiple keys authentication, a password 'toyota' is set for key 1 in key chain 'cars'. Authentication is enabled on eth1 and the authentication mode is set to MD5:

```
awplus# configure terminal
awplus(config)# key chain cars
awplus(config-keychain)# key 1
awplus(config-keychain-key)# key-string toyota
awplus(config-keychain-key)# accept-lifetime 10:00:00 Oct 08
2016 duration 43200
awplus(config-keychain-key)# send-lifetime 10:00:00 Oct 08 2016
duration 43200
awplus(config-keychain-key)# exit
awplus(config-keychain)# exit
awplus(config)# interface eth1
awplus(config-if)# ip rip authentication key-chain cars
awplus(config-if)# ip rip authentication mode md5
```

Related commands [ip rip authentication string](#)
[ip rip authentication key-chain](#)

ip rip authentication string

Overview Use this command to specify the authentication string or password used by a key. Use the **no** variant of this command to remove the authentication string.

Syntax `ip rip authentication string <auth-string>`
`no ip rip authentication string`

Parameter	Description
<code><auth-string></code>	The authentication string or password used by a key. It is an alphanumeric string and can include spaces.

Mode Interface Configuration for a VLAN interface, an Eth interface, an 802.1Q sub-interface, a PPP interface, a bridge, or a tunnel.

Usage notes The AlliedWare Plus™ implementation provides the choice of configuring authentication for single key or multiple keys at different times. Use this command to specify the password for a single key on an interface. Use the [ip rip authentication key-chain](#) command for multiple keys authentication. For information about configuring RIP, see the [RIP Feature Overview and Configuration Guide](#).

Use the following steps to configure a route to enable RIPv2 authentication using a single key or password:

- 1) Define the authentication string or password used by the key for the desired interface, using the following commands:

```
awplus# configure terminal
awplus(config)# interface <id>
```

- 2) Specify the mode of authentication for the given interface (text or MD5), using the following commands:

```
awplus# configure terminal
awplus(config-if)# ip rip authentication string <auth-string>
awplus(config)# interface <id>
awplus(config-if)# ip rip authentication mode {md5|text}
```

Example To specify 'mykey' as the authentication string and use MD5 authentication for the interface eth1, use the commands:

```
awplus# configure terminal
awplus(config)# interface eth1
awplus(config-if)# ip rip authentication string mykey
awplus(config-if)# ip rip authentication mode md5
```

Any RIP packet received on that interface should have the same string as its password.

Related commands [ip rip authentication key-chain](#)
[ip rip authentication mode](#)

ip rip receive-packet

Overview Use this command to configure the interface to enable the reception of RIP packets.

Use the **no** variant of this command to disable this feature.

Syntax `ip rip receive-packet`
`no ip rip receive-packet`

Default Enabled

Mode Interface Configuration for a VLAN interface, an Eth interface, an 802.1Q sub-interface, a PPP interface, a bridge, or a tunnel.

Example To turn on packet receiving on the interface eth1, use the commands:

```
awplus# configure terminal
awplus(config)# interface eth1
awplus(config-if)# ip rip receive-packet
```

Related commands [ip rip send-packet](#)

ip rip receive version

Overview Use this command to specify the version of RIP packets accepted on an interface and override the setting of the version command.

Use the **no** variant of this command to use the setting specified by the [version \(RIP\)](#) command.

Syntax `ip rip receive version [1] [2]`
`no ip rip receive version`

Parameter	Description
1	Specifies acceptance of RIP version 1 packets on the interface.
2	Specifies acceptance of RIP version 2 packets on the interface.

Default Version 2

Mode Interface Configuration for a VLAN interface, an Eth interface, an 802.1Q sub-interface, a PPP interface, a bridge, or a tunnel.

Usage notes This command applies to a specific interface and overrides the version specified by the [version \(RIP\)](#) command.

RIP can be run in version 1 or version 2 mode. Version 2 has more features than version 1; in particular RIP version 2 supports authentication and classless routing. Once the RIP version is set, RIP packets of that version will be received and sent on all the RIP-enabled interfaces.

Example To set the interface eth1 to receive both RIP version 1 and 2 packets, use the commands:

```
awplus# configure terminal
awplus(config)# interface eth1
awplus(config-if)# ip rip receive version 1 2
```

Related commands [version \(RIP\)](#)

ip rip send-packet

Overview Use this command to enable sending RIP packets through the current interface. Use the **no** variant of this command to disable this feature.

Syntax `ip rip send-packet`
`no ip rip send-packet`

Default Enabled

Mode Interface Configuration for a VLAN interface, an Eth interface, an 802.1Q sub-interface, a PPP interface, a bridge, or a tunnel.

Example To turn on packet sending on the interface eth1, use the commands:

```
awplus# configure terminal
awplus(config)# interface eth1
awplus(config-if)# ip rip send-packet
```

Related commands [ip rip receive-packet](#)

ip rip send version

Overview Use this command in Interface Configuration mode to specify the version of RIP packets sent on an interface and override the setting of the [version \(RIP\)](#) command. This mechanism causes RIP version 2 interfaces to send multicast packets instead of broadcasting packets.

Use the **no** variant of this command to use the setting specified by the [version \(RIP\)](#) command.

Syntax `ip rip send version {1|2|1 2|2 1}`
`no ip rip send version`

Parameter	Description
1	Specifies the sending of RIP version 1 packets out of an interface.
2	Specifies the sending of RIP version 2 packets out of an interface.
1 2	Specifies the sending of both RIP version 1 and RIP version 2 packets out of an interface.
2 1	Specifies the sending of both RIP version 2 and RIP version 1 packets out of an interface.

Default Version 2

Mode Interface Configuration for a VLAN interface, an Eth interface, an 802.1Q sub-interface, a PPP interface, a bridge, or a tunnel.

Usage notes This command applies to a specific interface and overrides the version specified by the [version \(RIP\)](#) command.

RIP can be run in version 1 or version 2 mode. Version 2 has more features than version 1; in particular RIP version 2 supports authentication and classless routing. Once the RIP version is set, RIP packets of that version will be received and sent on all the RIP-enabled interfaces. Selecting version parameters 1 2 or 2 1 sends RIP version 1 and 2 packets.

Use the [ip rip send version 1-compatible](#) command in an environment where you cannot send multicast packets. For example, in environments where multicast is not enabled and where hosts do not listen to multicast.

Examples To set the interface eth1 to send both RIP version 1 and 2 packets, use the commands:

```
awplus# configure terminal
awplus(config)# interface eth1
awplus(config-if)# ip rip send version 1 2
```

To set the interface eth1 to use the RIP version specified by the [version \(RIP\)](#) command, use the commands:

```
awplus# configure terminal
awplus(config)# interface eth1
awplus(config-if)# no ip rip send version
```

Related commands [ip rip send version 1-compatible](#)
[version \(RIP\)](#)

ip rip send version 1-compatible

Overview Use this command in Interface Configuration mode to send RIP version 1 compatible packets from a RIP version 2 interface to other RIP Interfaces. This mechanism causes RIP version 2 interfaces to send broadcast packets instead of multicasting packets, and is used in environments where multicast is not enabled or where hosts do not listen to multicast.

Use the **no** variant of this command to use the setting specified by the [version \(RIP\)](#) command, and disable the broadcast of RIP version 2 packets that are sent as broadcast packets.

Syntax `ip rip send version 1-compatible`
`no ip rip send version`

Parameter	Description
1-compatible	Specify this parameter to send RIP version 1 compatible packets from a version 2 RIP interface to other RIP interfaces. This mechanism causes version 2 RIP interfaces to broadcast packets instead of multicasting packets.

Default RIP version 2 is enabled by default.

Mode Interface Configuration for a VLAN interface, an Eth interface, an 802.1Q sub-interface, a PPP interface, a bridge, or a tunnel.

Usage notes This command applies to a specific interface and overrides the version specified by the [version \(RIP\)](#) command.

RIP can be run in version 1 compatible mode. Version 2 has more features than version 1; in particular RIP version 2 supports authentication and classless routing. Once the RIP version is set, RIP packets of that version will be received and sent on all the RIP-enabled interfaces.

Use the [ip rip send version](#) command in an environment where you can send multicast packets, for example, in environments where multicast is enabled and where hosts listen to multicast.

Example To set the interface eth1 to send RIP version 1-compatible packets, use the commands:

```
awplus# configure terminal
awplus(config)# interface eth1
awplus(config-if)# ip rip send version 1-compatible
```

Related commands [ip rip send version](#)
[version \(RIP\)](#)

ip rip split-horizon

Overview Use this command to turn on the split-horizon mechanism on the interface. Use the **no** variant of this command to disable this mechanism.

Syntax `ip rip split-horizon [poisoned]`
`no ip rip split-horizon`

Parameter	Description
poisoned	Performs split-horizon with poison-reverse. See "Usage" below for more information.

Default Split horizon poisoned

Mode Interface Configuration for a VLAN interface, an Eth interface, an 802.1Q sub-interface, a PPP interface, a bridge, or a tunnel.

Usage notes Use this command to avoid including routes in updates sent to the same gateway from which they were learned. Without the **poisoned** parameter, using this command causes routes learned from a neighbor to be omitted from updates sent to that neighbor. With the **poisoned** parameter, using this command causes such routes to be included in updates, but sets their metrics to infinity. This advertises that these routes are not reachable.

Example To turn on split horizon poisoned on eth1, use the following commands:

```
awplus# configure terminal
awplus(config)# interface eth1
awplus(config-if)# ip rip split-horizon poisoned
```

key

Overview Use this command to manage, add and delete authentication keys in a key-chain. Use the **no** variant of this command to delete the authentication key.

Syntax `key <keyid>`
`no key <keyid>`

Parameter	Description
<keyid>	<0-2147483647> Key identifier number.

Mode Keychain Configuration

Usage This command allows you to enter the keychain-key mode where a password can be set for the key.

Example The following example configures a key number 1 and shows the change into a **keychain- key** command mode prompt.

```
awplus# configure terminal
awplus(config)# key chain mychain
awplus(config-keychain)# key 1
awplus(config-keychain-key)#
```

Related commands [key chain](#)
[key-string](#)
[accept-lifetime](#)
[send-lifetime](#)

key chain

Overview Use this command to enter the key chain management mode and to configure a key chain with a key chain name.

Use the **no** variant of this command to remove the key chain and all configured keys.

Syntax `key chain <key-chain-name>`
`no key chain <key-chain-name>`

Parameter	Description
<code><key-chain-name></code>	Specify the name of the key chain to manage.

Mode Global Configuration

Usage This command allows you to enter the keychain mode from which you can specify keys on this key chain.

Example The following example shows the creation of a key chain named `mychain` and the change into **keychain** mode prompt.

```
awplus# configure terminal
awplus(config)# key chain mychain
awplus(config-keychain)#
```

Related commands

[key](#)
[key-string](#)
[accept-lifetime](#)
[send-lifetime](#)

key-string

Overview Use this command to define the password to be used by a key.
Use the **no** variant of this command to remove a password.

Syntax `key-string <key-password>`
`no key-string`

Parameter	Description
<code><key-password></code>	A string of characters to be used as a password by the key.

Mode Keychain-key Configuration

Usage Use this command to specify passwords for different keys.

Examples In the following example, the password for `key1` in the key chain named `mychain` is set to password **prime**:

```
awplus# configure terminal
awplus(config)# key chain mychain
awplus(config-keychain)# key 1
awplus(config-keychain-key)# key-string prime
```

In the following example, the password for `key1` in the key chain named `mychain` is removed:

```
awplus# configure terminal
awplus(config)# key chain mychain
awplus(config-keychain)# key 1
awplus(config-keychain-key)# no key-string
```

Related commands [key](#)
[key chain](#)
[accept-lifetime](#)
[send-lifetime](#)

maximum-prefix

Overview Use this command to configure the maximum number of RIP routes stored by the device.

Use the **no** variant of this command to disable all limiting of the number of RIP routes stored by the device.

Syntax `maximum-prefix <maxprefix> [<threshold>]`
`no maximum-prefix`

Parameter	Description
<code><maxprefix></code>	<code><1-65535></code> The maximum number of RIP routes allowed.
<code><threshold></code>	<code><1-100></code> Percentage of maximum routes to generate a warning. The default threshold is 75%.

Mode Router Configuration

Example To configure the maximum number of RIP routes to 150, use the following command:

```
awplus# configure terminal
awplus(config)# router rip
awplus(config-router)# maximum-prefix 150
```

neighbor (RIP)

Overview Use this command to specify a neighbor router. It is used for each router to which you wish to send unicast RIP updates.

Use the **no** variant of this command to stop sending unicast updates to the specific router.

Syntax `neighbor <ip-address>`
`no neighbor <ip-address>`

Parameter	Description
<code><ip-address></code>	The IP address of a neighboring router with which the routing information will be exchanged.

Default Disabled

Mode Router Configuration

Usage Use this command to exchange nonbroadcast routing information. It can be used multiple times for additional neighbors.

The [passive-interface \(RIP\)](#) command disables sending routing updates on an interface. If you want to send routing updates only to specific neighbors, use the [passive-interface \(RIP\)](#) command and this **neighbor** command together.

Example To specify the neighbor router to 1.1.1.1, use the following command:

```
awplus# configure terminal
awplus(config)# router rip
awplus(config-router)# passive-interface vlan1
awplus(config-router)# neighbor 1.1.1.1
```

Related commands [passive-interface \(RIP\)](#)

network (RIP)

Overview Use this command to activate the transmission of RIP routing information on the defined network.

Use the **no** variant of this command to remove the specified network or interface as one that runs RIP.

Syntax `network {<network-address>[/<subnet-mask>]|<interface>}`
`no network {<network-address>[/<subnet-mask>]|<interface>}`

Parameter	Description
<code><network-address></code> <code>[/<subnet-mask>]</code>	Specifies the network address to run RIP. Entering a subnet mask (or prefix length) for the network address is optional. Where no mask is entered, the device will attempt to apply a mask that is appropriate to the class (A, B, or C) of the address entered, e.g. an IP address of 10.0.0.0 will have a prefix length of 8 applied to it.
<code><interface></code>	Specify an interface to run RIP.

Default Disabled

Mode RIP Router Configuration or RIP Router Address Family Configuration for a VRF instance.

Usage notes Use this command to specify networks, by IP address or interface, to which routing updates will be sent and received. The connected routes corresponding to the specified network will be automatically advertised in RIP updates. RIP updates will be sent and received within the specified network.

When running VRF-lite, this command can be applied to a VRF instance.

Example Use the following commands to activate RIP routing updates on network 172.16.20.0/24:

```
awplus# configure terminal
awplus(config)# router rip
awplus(config-router)# network 172.16.20.0/24
```

Example (VRF-lite) To activate RIP routing updates on vln3 for VRF instance 'blue'.

```
awplus# configure terminal
awplus(config)# router rip
awplus(config-router)# address-family ipv4 vrf blue
awplus(config-router-af)# network vln3
```

Related commands show ip rip
show running-config
clear ip rip route

Command changes Version 5.4.6-2.1: VRF-lite support added.

passive-interface (RIP)

Overview Use this command to block RIP broadcasts on the interface.
Use the **no** variant of this command to disable this function.

Syntax `passive-interface <interface>`
`no passive-interface <interface>`

Parameter	Description
<code><interface></code>	Specifies the interface name.

Default Disabled

Mode RIP Router Configuration or RIP Router Address Family Configuration for a VRF instance.

Example Use the following commands to block RIP broadcasts on eth1:

```
awplus# configure terminal
awplus(config)# router rip
awplus(config-router)# passive-interface eth1
```

Example (VRF-lite) To apply the example above to a specific VRF instance named 'green', use the following commands:

```
awplus# configure terminal
awplus(config)# router rip
awplus(config-router)# address-family ipv4 vrf green
awplus(config-router-af)# passive-interface eth1
```

Related commands [show ip rip](#)

Command changes Version 5.4.6-2.1: VRF-lite support added.

recv-buffer-size (RIP)

Overview Use this command to run-time configure the RIP UDP (User Datagram Protocol) receive-buffer size to improve UDP reliability by avoiding UDP receive buffer overrun.

Use the **no** variant of this command to reset the configured RIP UDP receive-buffer size to the system default (196608 bits).

Syntax `recv-buffer-size <8192-2147483647>`
`no recv-buffer-size [<8192-2147483647>]`

Parameter	Description
<code><8192-2147483647></code>	Specify the RIP UDP (User Datagram Protocol) buffer size value in bits.

Default 196608 bits is the system default when reset using the **no** variant of this command.

Mode Router Configuration

Examples To run-time configure the RIP UDP, use the following commands:

```
awplus# configure terminal
awplus(config)# router rip
awplus(config-router)# recv-buffer-size 23456789
awplus# configure terminal
awplus(config)# router rip
awplus(config-router)# no recv-buffer-size 23456789
```

redistribute (RIP)

Overview Use this command to redistribute information from other routing protocols into RIP.

When using VRF-lite, you can apply this command to a specific VRF instance.

Use the **no** variant of this command to disable the specified redistribution. The parameters **metric** and **route-map** may be used with the **no** variant, but have no effect.

Syntax `redistribute {connected|static|ospf|bgp} [metric <0-16>]
[route-map <route-map>]`
`no redistribute {connected|static|ospf|bgp} [metric] [route-map]`

Parameter	Description
<code>route-map</code>	Optional. Specifies route-map that controls how routes are redistributed.
<code><route-map></code>	Optional. The name of the route map.
<code>connected</code>	Redistribute from connected routes.
<code>static</code>	Redistribute from static routes.
<code>ospf</code>	Redistribute from Open Shortest Path First (OSPF).
<code>bgp</code>	Redistribute from Border Gateway Protocol (BGP).
<code>metric <0-16></code>	Optional. Sets the value of the metric that will be applied to routes redistributed into RIP from other protocols. If a value is not specified, and no value is specified using the default-metric (RIP) command, the default is one.

Default By default, the RIP metric value is set to 1.

Mode RIP Router Configuration or RIP Router Address Family Configuration for a VRF instance.

Example To apply the metric value 15 to static routes being redistributed into RIP, use the commands:

```
awplus# configure terminal
awplus(config)# router rip
awplus(config-router)# redistribute static metric 15
```

Example (VRF-lite) To apply the metric value 15 to static routes in address-family ipv4 VRF instance blue being redistributed into RIP, use the following commands:

```
awplus# configure terminal
awplus(config)# router rip
awplus(config-router)# address-family ipv4 vrf blue
awplus(config-router-af)# redistribute static metric 15
```

Related commands [default-metric \(RIP\)](#)

Command changes Version 5.4.6-2.1: VRF-lite support added.

restart rip graceful

Overview Use this command to force the RIP process to restart, and optionally set the grace-period.

Syntax `restart rip graceful [grace-period <1-65535>]`

Mode Privileged Exec

Default The default RIP grace-period is 60 seconds.

Usage notes After this command is executed, the RIP process immediately shuts down. It notifies the system that RIP has performed a graceful shutdown. Routes that have been installed into the route table by RIP are preserved until the specified grace-period expires.

When a **restart rip graceful** command is issued, the RIP configuration is reloaded from the last saved configuration. Ensure you first enter the command `copy running-config startup-config`.

Example To apply a restart rip graceful setting, grace-period to 100 seconds use the following commands:

```
awplus# copy running-config startup-config
awplus# restart rip graceful grace-period 100
```

rip restart grace-period

Overview Use this command to change the grace period of RIP graceful restart.
Use the **no** variant of this command to disable this function.

Syntax `rip restart grace-period <1-65535>`
`no rip restart grace-period <1-65535>`

Mode Global Configuration

Default The default RIP grace-period is 60 seconds.

Usage notes Use this command to enable the **Graceful Restart** feature on the RIP process.
Entering this command configures a grace period for RIP.

Example `awplus# configure terminal`
`awplus(config)# rip restart grace-period 200`

route (RIP)

Overview Use this command to add a static RIP route.
Use the **no** variant of this command to remove a static RIP route.

Syntax `route <ip-addr/prefix-length>`
`no route <ip-addr/prefix-length>`

Parameter	Description
<code><ip-addr/prefix-length></code>	The IPv4 address and prefix length.

Default No static RIP route is added by default.

Mode RIP Router Configuration or RIP Router Address Family Configuration for a VRF instance.

Usage notes Use this command to add a static RIP route. After adding the RIP route, the route can be checked in the RIP routing table.

Example To create a static RIP route to IP subnet 192.168.1.0/24, use the following commands:

```
awplus# configure terminal
awplus(config)# router rip
awplus(config-router)# route 192.168.1.0/24
```

Example (VRF-lite) To create a static RIP route to IP subnet 192.168.1.0/24, for the VRF instance red, use the following commands

```
awplus# configure terminal
awplus(config)# router rip
awplus(config-router)# address-family ipv4 vrf red
awplus(config-router-af)# route 192.168.1.0/24
```

Related commands [show ip rip](#)
[clear ip rip route](#)

Command changes Version 5.4.6-2.1: VRF-lite support added.

router rip

Overview Use this global command to enter Router Configuration mode to enable the RIP routing process.

Use the **no** variant of this command to disable the RIP routing process.

Syntax `router rip`
`no router rip`

Mode Global Configuration

Example This command is used to begin the RIP routing process:

```
awplus# configure terminal
awplus(config)# router rip
awplus(config-router)# version 1
awplus(config-router)# network 10.10.10.0/24
awplus(config-router)# network 10.10.11.0/24
awplus(config-router)# neighbor 10.10.10.10
```

Related commands [network \(RIP\)](#)
[version \(RIP\)](#)

send-lifetime

Overview Use this command to specify the time period during which the authentication key on a key chain can be sent.

Syntax `send-lifetime <start-date> {<end-date>|
duration <seconds>|infinite}`
`no send-lifetime`

Parameter	Description
<code><start-date></code>	Specifies the start time and date in the format: <code><hh:mm:ss> <day> <month> <year></code> or <code><hh:mm:ss> <month> <day> <year></code> , where:
<code><hh:mm:ss></code>	The time of the day, in hours, minutes and seconds
<code><day></code>	<1-31> The day of the month
<code><month></code>	The month of the year (the first three letters of the month, for example, Jan)
<code><year></code>	<1993-2035> The year
<code><end-date></code>	Specifies the end time and date in the format: <code><hh:mm:ss> <day> <month> <year></code> or <code><hh:mm:ss> <month> <day> <year></code> , where:
<code><hh:mm:ss></code>	The time of the day, in hours, minutes and seconds
<code><day></code>	<1-31> The day of the month
<code><month></code>	The month of the year (the first three letters of the month, for example, Jan)
<code><year></code>	<1993-2035> The year
<code><seconds></code>	<1-2147483646> Duration of the key in seconds.
<code>infinite</code>	Never expires.

Mode Keychain-key Configuration

Example The following example shows the setting of send-lifetime for key 1 on the key chain named "mychain".

```
awplus# configure terminal
awplus(config)# key chain mychain
awplus(config-keychain)# key 1
awplus(config-keychain-key)# send-lifetime 03:03:01 Jan 3 2016
04:04:02 Dec 6 2016
```

**Related
commands** [key](#)
[key-string](#)
[key chain](#)
[accept-lifetime](#)

show debugging rip

Overview Use this command to display the RIP debugging status for these debugging options: nsm debugging, RIP event debugging, RIP packet debugging and RIP nsm debugging.

For information on filtering and saving command output, see the [“Getting_Started with AlliedWare Plus” Feature Overview and Configuration_Guide](#).

Syntax `show debugging rip`

Mode User Exec and Privileged Exec

Usage notes Use this command to display the debug status of RIP.

Example `awplus# show debugging rip`

show ip prefix-list

Overview Use this command to display the IPv4 prefix-list entries.
Note that this command is valid for RIP and BGP routing protocols only.

Syntax `show ip prefix-list [<name>|detail|summary]`

Parameter	Description
<name>	Specify the name of a prefix list in this placeholder.
detail	Specify this parameter to show detailed output for all IPv4 prefix lists.
summary	Specify this parameter to show summary output for all IPv4 prefix lists.

Mode User Exec and Privileged Exec

Example

```
awplus# show ip prefix-list
awplus# show ip prefix-list 10.10.0.98/8
awplus# show ip prefix-list detail
```

Related commands [ip prefix-list](#)

show ip protocols rip

Overview Use this command to display RIP process parameters and statistics.
For information on filtering and saving command output, see the [“Getting_Started with AlliedWare Plus” Feature Overview and Configuration_Guide](#).

Syntax `show ip protocols rip`

Mode User Exec and Privileged Exec

Example `awplus# show ip protocols rip`

Output Figure 25-1: Example output from the **show ip protocols rip** command

```
Routing Protocol is "rip"
Sending updates every 30 seconds with +/-50%, next due in 12
seconds
Timeout after 180 seconds, garbage collect after 120 seconds
Outgoing update filter list for all interface is not set
Incoming update filter list for all interface is not set
Default redistribution metric is 1
Redistributing: connected static
Default version control: send version 2, receive version 2
Interface          Send  Recv  Key-chain
   vlan25           2    2
Routing for Networks:
  10.10.0.0/24
Routing Information Sources:
  Gateway          BadPackets BadRoutes  Distance Last Update
Distance: (default is 120
```

show ip rip

Overview Use this command to show RIP routes.

For information on filtering and saving command output, see the [“Getting Started with AlliedWare Plus” Feature Overview and Configuration Guide](#).

Syntax `show ip rip`

Mode User Exec and Privileged Exec

Example `awplus# show ip rip`

Output Figure 25-2: Example output from the **show ip rip** command

```
awplus#show ip rip
Codes: R - RIP, Rc - RIP connected, Rs - RIP static
       C - Connected, S - Static, O - OSPF, B - BGP
Network      Next Hop Metric From If      Time
C 10.0.1.0/24          1      eth1
S 10.10.10.0/24        1      eth1
C 10.10.11.0/24        1      eth1
S 192.168.101.0/24     1      eth1
R 192.192.192.0/24     1      --
```

Related commands [route \(RIP\)](#)
[network \(RIP\)](#)

[clear ip rip route](#)
[show ip rip vrf interface](#)

Command changes Version 5.4.6-2.1: VRF-lite support added.

show ip rip database

Overview Use this command to display information about the RIP database.
For information on filtering and saving command output, see the [“Getting_Started with AlliedWare Plus” Feature Overview and Configuration_Guide](#).

Syntax `show ip rip database [full]`

Parameter	Description
full	Specify the full RIP database including sub-optimal RIP routes.

Mode User Exec and Privileged Exec

Example
`awplus# show ip rip database`
`awplus# show ip rip database full`

Related commands [show ip rip](#)

show ip rip interface

Overview Use this command to display information about the RIP interfaces. You can specify an interface name to display information about a specific interface.

Syntax `show ip rip interface [<interface>]`

Parameter	Description
<interface>	The interface to display information about.

Mode User Exec and Privileged Exec

Example `awplus# show ip rip interface`

show ip rip vrf database

Overview Use this command to display information about the RIP database that is associated with a specific VRF instance.

Entering this command with the **full** option included, will display information about the full RIP database (including sub-optimal routes) associated with a specific VRF instance.

For information on filtering and saving command output, see the [“Getting Started with AlliedWare Plus” Feature Overview and Configuration Guide](#).

Syntax `show ip rip {vrf <vrf-name>|global} database [full]`

Parameter	Description
vrf	Specific VRF instance.
<vrf-name>	The name of the VRF instance.
global	The global routing and forwarding table.
full	Specify the full RIP database including sub-optimal RIP routes.

Mode User Exec and Privileged Exec

Example To display information about the RIP database associated with a VRF instance 'blue', use the command:

```
awplus# show ip rip vrf blue database
```

Output Figure 25-3: Example output from the **show ip rip vrf blue database** command

```
Codes: R - RIP, Rc - RIP connected, Rs - RIP static
       C - Connected, S - Static, O - OSPF, B - BGP
```

Network	Next Hop	Metric	From	If	Time
Rc 192.168.30.0/24		1		vlan3	
R 192.168.45.0/24	192.168.30.1	2	192.168.30.1	vlan3	02:46

Related commands [show ip rip](#)

Command changes Version 5.4.6-2.1: VRF-lite support added.

show ip rip vrf interface

Overview Use this command to display information about the RIP interfaces that are associated with a specific VRF instance.

For information on filtering and saving command output, see the [“Getting Started with AlliedWare Plus” Feature Overview and Configuration Guide](#).

Syntax `show ip rip {vrf <vrf-name>|global} interface [<interface-name>]`

Parameter	Description
vrf	Specific VRF instance.
<vrf-name>	The name of the VRF instance.
global	The global routing and forwarding table.
<interface-name>	The IP RIP interface (VLAN).

Mode User Exec and Privileged Exec

Example To display information about the RIP database associated with a VRF instance 'blue', use the command:

```
awplus# show ip rip vrf blue interface
```

Output Figure 25-4: Example output from **show ip rip vrf blue interface vlan3**

Codes: R - RIP, Rc - RIP connected, Rs - RIP static C - Connected, S - Static, O - OSPF, B - BGP						
	Network	Next Hop	Metric	From	If	Time
Rc	192.168.30.0/24		1		vlan3	
R	192.168.45.0/24	192.168.30.1	2	192.168.30.1	vlan3	02:46

NOTE: The Time parameter operates as follows:

- RIP updates occur approximately every 30 seconds.
- Each update resets a count-down timer to 180 seconds (3 minutes).
- The Time parameter displays the count-down from the last reset.

Related commands [show ip rip](#)

Command changes Version 5.4.6-2.1: VRF-lite support added.

timers (RIP)

Overview Use this command to adjust routing network timers.
Use the **no** variant of this command to restore the defaults.

Syntax `timers basic <update> <timeout> <garbage>`
`no timers basic`

Parameter	Description
<code><update></code>	<code><5-2147483647></code> Specifies the period at which RIP route update packets are transmitted. The default is 30 seconds.
<code><timeout></code>	<code><5-2147483647></code> Specifies the routing information timeout timer in seconds. The default is 180 seconds. After this interval has elapsed and no updates for a route are received, the route is declared invalid.
<code><garbage></code>	<code><5-2147483647></code> Specifies the routing garbage collection timer in seconds. The default is 120 seconds.

Default Enabled

Mode RIP Router Configuration or RIP Router Address Family Configuration for a VRF instance.

Usage notes This command adjusts the RIP timing parameters.

The update timer is the time between sending out updates, that contain the complete routing table, to every neighboring router.

If an update for a given route has not been seen for the time specified by the timeout parameter, that route is no longer valid. However, it is retained in the routing table for a short time, with metric 16, so that neighbors are notified that the route has been dropped.

When the time specified by the garbage parameter expires the metric 16 route is finally removed from the routing table. Until the garbage time expires, the route is included in all updates sent by the router.

All the routers in the network must have the same timers to ensure the smooth operation of RIP throughout the network.

Examples To set the update timer to 30, the routing information timeout timer to 180, and the routing garbage collection timer to 120, use the following command:

```
awplus# configure terminal
awplus(config)# router rip
awplus(config-router)# timers basic 30 180 120
```

To set the update timer to 30, the routing information timeout timer to 180, and the routing garbage collection timer to 120 with VRF, use the following command:

```
awplus# configure terminal
awplus(config)# router rip
awplus(config-router)# address-family ipv4 vrf blue
awplus(config-router-af)# timers basic 30 180 120
```

Command changes Version 5.4.6-2.1: VRF-lite support added.

undebg rip

Overview Use this command to disable the options set for debugging information of RIP events, packets and communication between RIP and NSM.

This command has the same effect as the **no debug rip** command.

Syntax `undebg rip {all|events|nsm|<packet>}`

Parameter	Description
all	Disables all RIP debugging.
events	Disables the logging of RIP events.
nsm	Disables the logging of RIP and NSM communication.
<packet>	packet [recv send] [detail] Disables the debugging of RIP packets.
recv	Disables the logging of received packet information.
send	Disables the logging of sent packet information.
detail	Disables the logging of sent or received RIP packets.

Mode Privileged Exec

Example To disable the options set for debugging RIP information events, use the following command:

```
awplus# undebg rip packet
```

Related commands [debug rip](#)

version (RIP)

Overview Use this command to specify a RIP version used globally by the router.

If VRF-lite is configured, you can specify a RIP version either globally, or for a particular VRF instance.

Use the **no** variant of this command to restore the default version.

Syntax `version {1|2}`
`no version`

Parameter	Description
1 2	Specifies the version of RIP processing.

Default Version 2

Mode RIP Router Configuration or RIP Router Address Family Configuration for a VRF instance.

Usage notes RIP can be run in version 1 or version 2 mode. Version 2 has more features than version 1; in particular RIP version 2 supports authentication and classless routing. Once the RIP version is set, RIP packets of that version will be received and sent on all the RIP-enabled interfaces.

Setting the version command has no impact on receiving updates, only on sending them. The `ip rip send version` command overrides the value set by the `version (RIP)` command on an interface-specific basis. The `ip rip receive version` command allows you to configure a specific interface to accept only packets of the specified RIP version. The `ip rip receive version` command and the `ip rip send version` command override the value set by this command.

Examples To specify a RIP version, use the following commands:

```
awplus# configure terminal
awplus(config)# router rip
awplus(config-router)# version 1
```

To specify a RIP version with VRF, use the following commands:

```
awplus# configure terminal
awplus(config)# router rip
awplus(config-router)# address-family ipv4 vrf blue
awplus(config-router-af)# version 1
```

Related commands [ip rip receive version](#)
[ip rip send version](#)
[show running-config](#)

Command changes Version 5.4.6-2.1: VRF-lite support added.

26

RIPng for IPv6 Commands

Introduction

Overview This chapter contains RIPng commands. RIPng (Routing Information Protocol next generation) is an extension of RIPv2 to support IPv6. RFC 2080 specifies RIPng. The differences between RIPv2 and RIPng are:

- RIPng does not support RIP updates authentication
- RIPng does not allow the attachment of arbitrary tags to routes
- RIPng requires the encoding of the next-hop for a set of routes

For more information, see the [RIPng Feature Overview and Configuration Guide](#).

- Command List**
- [“aggregate-address \(IPv6 RIPng\)”](#) on page 1007
 - [“clear ipv6 rip route”](#) on page 1008
 - [“debug ipv6 rip”](#) on page 1009
 - [“default-information originate \(IPv6 RIPng\)”](#) on page 1010
 - [“default-metric \(IPv6 RIPng\)”](#) on page 1011
 - [“distribute-list \(IPv6 RIPng\)”](#) on page 1012
 - [“ipv6 prefix-list”](#) on page 1013
 - [“ipv6 rip metric-offset”](#) on page 1015
 - [“ipv6 rip split-horizon”](#) on page 1017
 - [“ipv6 router rip”](#) on page 1018
 - [“neighbor \(IPv6 RIPng\)”](#) on page 1019
 - [“passive-interface \(IPv6 RIPng\)”](#) on page 1020
 - [“recv-buffer-size \(IPv6 RIPng\)”](#) on page 1021
 - [“redistribute \(IPv6 RIPng\)”](#) on page 1022
 - [“route \(IPv6 RIPng\)”](#) on page 1023

- [“router ipv6 rip”](#) on page 1024
- [“show debugging ipv6 rip”](#) on page 1025
- [“show ipv6 prefix-list”](#) on page 1026
- [“show ipv6 protocols rip”](#) on page 1027
- [“show ipv6 rip”](#) on page 1028
- [“show ipv6 rip database”](#) on page 1029
- [“show ipv6 rip interface”](#) on page 1030
- [“timers \(IPv6 RIPng\)”](#) on page 1031
- [“undebug ipv6 rip”](#) on page 1032

aggregate-address (IPv6 RIPng)

Overview Use this command to add an aggregate route to RIPng.
Use the **no** variant of this command to remove the aggregate route from RIPng.

Syntax `aggregate-address <ipv6-addr/prefix-length>`
`no aggregate-address <ipv6-addr/prefix-length>`

Parameter	Description
<code><ipv6-addr/prefix-length></code>	Specify the IPv6 Address in the format <code>X:X::X:X/Prefix-Length</code> . The prefix-length is a decimal integer between 1 and 128.

Mode Router Configuration

Usage notes The route will not be added to the RIPng database unless the database contains at least one route which is contained within the address range covered by the aggregate route. As soon as there are any such component routes in the RIPng database, then the following occurs:

- the aggregate route is added to the RIPng database
- all the component routes that are within the address range covered by the aggregate route are retained in the RIPng database, but are marked as suppressed routes. The aggregate route will be advertised in RIPng updates, and the component route will no longer be advertised.

Note that simply having a component route in the IPv6 route database is not a sufficient condition for the aggregate route to be included into the RIPng database. The component route(s) must be in the RIPng database before the aggregate route will be included in the RIPng database. There is no restriction on the method by which the component routes have arrived into the RIPng database, it can be by being connected RIP interfaces, by redistribution or by direct inclusion using the **route** command in router IPv6 RIP configuration mode.

Example

```
awplus# configure terminal
awplus(config)# router ipv6 rip
awplus(config-router)# aggregate-address 2001:db8::/32
```

clear ipv6 rip route

Overview Use this command to clear specific data from the RIPng routing table.

Syntax `clear ipv6 rip route`
{<ipv6-addr/prefix-length>|all|connected|rip|static|ospf}

Parameter	Description
<ipv6-addr/ prefix-length>	Specify the IPv6 Address in format X:X::X:Prefix-Length. The prefix-length is a decimal integer between 1 and 128. Removes entries which exactly match this destination address from the RIPng routing table.
connected	Removes redistributed connected entries from RIPng routing table.
static	Removes redistributed static entries from the RIPng routing table.
rip	Removes RIPng routes from the RIPng routing table.
ospf	Removes redistributed OSPFv3 routes from the RIPng routing table.
all	Clears the entire RIPng routing table.

Mode Privileged Exec

Example `awplus# clear ipv6 rip route all`
`awplus# clear ipv6 rip route 2001:db8::/32`

debug ipv6 rip

Overview Use this command to enable RIPng debugging and specify debugging for RIPng events, RIPng packets, or RIPng communication with NSM processes.

Use the **no** variant of this command to disable RIPng debugging.

Syntax `debug ipv6 rip [all|events|nsm|packet [detail]|recv [detail]|send [detail]]`
`no debug ipv6 rip [all|events|nsm|packet [detail]|recv [detail]|send [detail]]`

Parameter	Description
all	Displays all RIPng debugging showing RIPng events debug information, RIPng received packets information, and RIPng sent packets information.
events	Displays RIPng events debug information.
nsm	Displays RIPng and NSM communication.
packet	Displays RIPng packets only.
recv	Displays information for received packets.
send	Displays information for sent packets.
detail	Displays detailed information for the sent or received packet.

Default RIPng debugging is disabled by default.

Mode Privileged Exec and Global Configuration

Example `awplus# debug ipv6 rip events`
`awplus# debug ipv6 rip packet send detail`
`awplus# debug ipv6 rip nsm`

Related commands [undebug ipv6 rip](#)

default-information originate (IPv6 RIPng)

Overview Use this command to generate a default route into RIPng.
Use the **no** variant of this command to disable this feature.

Syntax default-information originate
no default-information originate

Default Disabled

Mode Router Configuration

Example awplus# configure terminal
awplus(config)# router ipv6 rip
awplus(config-router)# default-information originate

default-metric (IPv6 RIPng)

Overview Use this command to specify the metrics to be assigned to redistributed RIPng routes.

Use the **no** variant of this command to reset the RIPng metric back to its default (1).

Syntax `default-metric <1-16>`
`no default-metric [<1-16>]`

Parameter	Description
<1-16>	Metric value.

Default By default, the RIPng metric value is set to 1.

Mode Router Configuration

Usage This command is used with the [redistribute \(IPv6 RIPng\)](#) command to make the routing protocol use the specified metric value for all redistributed RIPng routes, regardless of the original protocol that the route has been redistributed from.

Note, this metric is not applied to routes that are brought into RIPng by using the **route** command in router IPv6 RIP configuration mode. This metric is, though, applied to any RIPng aggregate routes that have been brought into the RIPng database due to the presence of a component route that was redistributed into RIPng.

Also note that the default-metric is applied to routes redistributed into RIPng with no metric assignment in the routemap associated with redistribution.

Example

```
awplus# configure terminal
awplus(config)# router ipv6 rip
awplus(config-router)# default-metric 8
```

Related commands [ipv6 rip metric-offset](#)
[redistribute \(IPv6 RIPng\)](#)

distribute-list (IPv6 RIPng)

Overview Use this command to filter incoming or outgoing route updates using the prefix-list.

Use the **no** variant of this command to disable this feature.

Syntax `distribute-list [prefix <prefix-list-name>] [in|out]
[<interface>]`
`no distribute-list [prefix <prefix-list-name>] [in|out]
[<interface>]`

Parameter	Description
<code><prefix-list-name></code>	Filter prefixes in routing updates. Specify the name of the IPv6 prefix-list to use.
<code><interface></code>	The interface for which distribute-list applies.
<code>in</code>	Filter incoming routing updates.
<code>out</code>	Filter outgoing routing updates.

Default Disabled

Mode Router Configuration

Usage notes Filter out incoming or outgoing route updates using the prefix-list. If you do not specify the name of the interface, the filter is applied to all the interfaces.

Example To filter incoming or outgoing route updates, use the following commands:

```
awplus# configure terminal
awplus(config)# router ipv6 rip
awplus(config-router)# distribute-list prefix myfilter in eth1
```

Related commands [ipv6 nd prefix](#)

ipv6 prefix-list

Overview Use this command to create an IPv6 prefix list or an entry in an existing prefix list.

Use the **no** variant of this command to delete a whole prefix list, a prefix list entry, or a description.

Syntax

```

ipv6 prefix-list <list-name> [seq <1-429496725>] {deny|permit}
{any|<ipv6-prefix>} [ge <0-128>] [le <0-128>]

ipv6 prefix-list <list-name> description <text>

no ipv6 prefix-list <list-name> [seq <1-429496725>]

no ipv6 prefix-list <list-name> [description <text>]
```

Parameter	Description
<list-name>	Specifies the name of a prefix list.
seq <1-429496725>	Sequence number of the prefix list entry.
deny	Specifies that the prefixes are excluded from the list.
permit	Specifies that the prefixes are included in the list.
<ipv6-prefix>	Specifies the IPv6 prefix and prefix length in hexadecimal in the format X:X::X:X/M.
any	Any prefix match. Same as ::0/0 le 128.
ge <0-128>	Specifies the minimum prefix length to be matched.
le <0-128>	Specifies the maximum prefix length to be matched.
description	Prefix list specific description.
<text>	Up to 80 characters of text description of the prefix list.

Mode Global Configuration

Usage notes When the device processes a prefix list, it starts to match prefixes from the top of the prefix list, and stops whenever a permit or deny occurs. To promote efficiency, use the **seq** parameter and place common permits or denials towards the top of the list. If you do not use the **seq** parameter, the sequence values are generated in a sequence of 5.

The parameters **ge** and **le** specify the range of the prefix lengths to be matched. The parameters **ge** and **le** are only used if an ip-prefix is stated. When setting these parameters, set the **le** value to be less than 128, and the **ge** value to be less than or equal to the **le** value and greater than the ip-prefix mask length.

Prefix lists implicitly exclude prefixes that are not explicitly permitted in the prefix list. This means if a prefix that is being checked against the prefix list reaches the end of the prefix list without matching a permit or deny, this prefix will be denied.

Example To check the first 32 bits of the prefix 2001:db8:: and that the subnet mask must be greater than or equal to 34 and less than or equal to 40, enter the following commands:

```
awplus# configure terminal
awplus(config)# ipv6 prefix-list mylist seq 12345 permit
2001:db8::/32 ge 34 le 40
```

Related commands

- [match ipv6 address](#)
- [show ipv6 prefix-list](#)
- [show running-config ipv6 prefix-list](#)

ipv6 rip metric-offset

Overview Use this command to increment the metric value on incoming routes for a specified interface. This command can be used to artificially inflate the metric value for routes learned on the specified interface. Routes learned on the specified interface are only used if the routes to the same destination with a lower metric value in the routing table are down.

Use the **no** variant of this command to reset the metric value on incoming routes to the default value (1). You can set the metric value for redistributed routes with [default-metric \(IPv6 RIPng\)](#) and [redistribute \(IPv6 RIPng\)](#) commands in Router Configuration mode.

Syntax `ipv6 rip metric-offset <1-16>`
`no ipv6 rip metric-offset <1-16>`

Parameter	Description
<1-16>	Specify an increment to the metric value on an incoming route. The metric value for RIPng routes is the hop count for the route.

Default The default RIPng metric value is 1.

Mode Interface Configuration for a VLAN interface, an Eth interface, an 802.1Q sub-interface, a PPP interface, a bridge, or a tunnel.

Usage notes When a RIPng route is received on an interface, the metric value for the interface set by this command is added to the metric value of the route in the routing table. Note this command only increments the metric for incoming routes on a specified interface. Increasing the metric value for an interface increases the metric value of routes received on that interface. This changes the route selected from the routing table.

The RIPng metric is the hop count. At regular intervals of the routing update timer (which has a default value of 30 seconds), and at the time of change in the topology, the RIPng router sends update messages to other routers. The listening routers update their route table with the new route, and increase the metric value of the path by one (referred to as a hop count). The router recognizes the IPv6 address advertising router as the next hop, then sends the routing updates to other routers. A maximum allowable hop count is 15. If a router reaches a metric value of 16 or more, the destination is identified as unreachable.

For information about how AlliedWare Plus adds routes, see the [“Route Selection” Feature Overview and Configuration Guide](#). See also the [default-metric \(IPv6 RIPng\)](#) and [redistribute \(IPv6 RIPng\)](#) commands to specify the metric for redistributed RIPng routes.

Examples To increment the metric-offset on the PPP interface ppp0, enter the commands:

```
awplus# configure terminal
awplus(config)# router ipv6 rip
awplus(config-router)# exit
awplus(config)# interface ppp0
awplus(config-if)# ipv6 rip metric-offset
```

To reset the metric-offset on the PPP interface ppp0 to the default value, enter the commands:

```
awplus# configure terminal
awplus(config)# interface ppp0
awplus(config-if)# no ipv6 router rip
```

Related commands [default-metric \(IPv6 RIPng\)](#)
[show running-config](#)

ipv6 rip split-horizon

Overview Use this command to perform the split-horizon action on the interface. The default is split-horizon with poisoned reverse.

Use the **no** variant of this command to disable this function.

Syntax `ipv6 rip split-horizon [poisoned]`
`no ipv6 rip split-horizon`

Parameter	Description
<code>split-horizon</code>	Perform split-horizon without poisoned reverse
<code>poisoned</code>	Performs split-horizon with poisoned reverse.

Default Split-horizon with poisoned reverse is the default.

Mode Interface Configuration for a VLAN interface, an Eth interface, an 802.1Q sub-interface, a PPP interface, a bridge, or a tunnel.

Usage notes Use this command to avoid including routes in updates sent to the same gateway from which they were learned. Using the **split horizon** command omits routes learned from one neighbor, in updates sent to that neighbor. Using the **poisoned** parameter with this command includes such routes in updates, but sets their metrics to infinity. Thus, advertising that these routes are not reachable.

Examples To perform split-horizon with poisoned reverse on the PPP interface ppp0, enter the commands:

```
awplus# configure terminal
awplus(config)# router ipv6 rip
awplus(config-router)# exit
awplus(config)# interface ppp0
awplus(config-if)# ipv6 rip split-horizon poisoned
```

To disable split-horizon on the PPP interface ppp0, enter the commands:

```
awplus# configure terminal
awplus(config)# interface ppp0
awplus(config-if)# no ipv6 rip split-horizon
```

Related Commands [show running-config](#)

ipv6 router rip

Overview Use this command to enable RIPng routing on an interface.
Use the **no** variant of this command to disable RIPng routing on an interface.

Syntax `ipv6 router rip`
`no ipv6 router rip`

Default RIPng routing is disabled by default.

Mode Interface Configuration for a VLAN interface, an Eth interface, an 802.1Q sub-interface, a PPP interface, a bridge, or a tunnel.

Examples To enable RIPng routing on the PPP interface ppp0, enter the commands:

```
awplus# configure terminal
awplus(config)# router ipv6 rip
awplus(config-router)# exit
awplus(config)# interface ppp0
awplus(config-if)# ipv6 router rip
```

To disable RIPng routing on the PPP interface ppp0, enter the commands:

```
awplus# configure terminal
awplus(config)# interface ppp0
awplus(config-if)# no ipv6 router rip
```

neighbor (IPv6 RIPng)

Overview Use this command to specify a neighbor router.
Use the **no** variant of this command to disable the specific router.

Syntax `neighbor <ipv6-link-local-addr> <interface>`
`no neighbor <ipv6-link-local-addr> <interface>`

Parameter	Description
<code><ipv6-link-local-addr></code>	Specify the link-local IPv6 address (in the format X:X::X:X) of a neighboring router to exchange routing information with.
<code><interface></code>	The interface to exchange routing information over.

Mode Router Configuration

Usage Use this command to exchange non broadcast routing information. It can be used multiple times for additional neighbors.

The [passive-interface \(IPv6 RIPng\)](#) command disables sending routing updates on an interface. If you want to send routing updates only to specific neighbors, use the [passive-interface \(IPv6 RIPng\)](#) command and this **neighbor** command together.

Examples To set 2001:db8:1::1 as a neighbor via interface eth1, use the commands:

```
awplus# configure terminal
awplus(config)# router ipv6 rip
awplus(config-router)# neighbor 2001:db8:1::1 eth1
```

To stop having 2001:db8:1::1 as a neighbor via interface eth1, use the commands:

```
awplus# configure terminal
awplus(config)# router ipv6 rip
awplus(config-router)# no neighbor 2001:db8:1::1 eth1
```

Related commands [passive-interface \(IPv6 RIPng\)](#)

passive-interface (IPv6 RIPng)

Overview Use this command to enable suppression of routing updates on an interface. Use the **no** variant of this command to disable this function.

Syntax `passive-interface <interface>`
`no passive-interface <interface>`

Parameter	Description
<code><interface></code>	The interface to suppress routing updates on.

Default Disabled

Mode Router Configuration

Examples To suppress routing updates on eth1, use the commands:

```
awplus# configure terminal
awplus(config)# router ipv6 rip
awplus(config-router)# passive-interface eth1
```

To stop suppressing routing updates on eth1, use the commands:

```
awplus# configure terminal
awplus(config)# router ipv6 rip
awplus(config-router)# no passive-interface eth1
```

recv-buffer-size (IPv6 RIPng)

Overview Use this command to configure the RIPng UDP (User Datagram Protocol) receive-buffer size. This should improve UDP reliability by avoiding UDP receive buffer overruns.

Use the **no** variant of this command to unset the configured RIPng UDP receive-buffer size and set it back to the system default of 196608 bits.

Syntax `recv-buffer-size <8192-2147483647>`
`no recv-buffer-size [<8192-2147483647>]`

Default The RIPng UDP receive-buffer-size is 196608 bits by default, and is reset to the default using the **no** variant of this command.

Mode Router Configuration

Examples To configure the RIPng UPD, use the following commands:

```
awplus# configure terminal
awplus(config)# router ipv6 rip
awplus(config-router)# recv-buffer-size 23456789
awplus# configure terminal
awplus(config)# router ipv6 rip
awplus(config-router)# no recv-buffer-size 23456789
awplus# configure terminal
awplus(config)# router ipv6 rip
awplus(config-router)# no recv-buffer-size
```

redistribute (IPv6 RIPng)

Overview Use this command to redistribute information from other routing protocols into RIPng.

Use the **no** variant of this command to disable the specified redistribution. The parameters **metric** and **route-map** may be used on this command, but have no effect.

Syntax redistribute {connected|static|ospf} [metric <0-16>] [route-map <route-map>]
no redistribute {connected|static|ospf} [metric <0-16>] [route-map <route-map>]

Parameter	Description
<0-16>	Optional. Specifies the metric value to be used when redistributing information. If a value is not specified, and no value is specified using the default-metric (IPv6 RIPng) command, the default is one.
<route-map>	Optional. Specifies route-map to be used to redistribute information.
connected	Redistribute from connected routes.
static	Redistribute from static routes.
ospf	Redistribute from Open Shortest Path First (OSPF).

Default By default, the RIPng metric value is set to 1.

Mode Router Configuration

Example To redistribute information from other routing protocols into RIPng, use the following commands:

```
awplus# configure terminal
awplus(config)# router ipv6 rip
awplus(config-router)# redistribute static route-map mymap
awplus(config-router)# redistribute static metric 8
```

Related commands [default-metric \(IPv6 RIPng\)](#)

route (IPv6 RIPng)

Overview Use this command to configure static RIPng routes.
Use the **no** variant of this command to disable this function.

Syntax `route <ipv6-addr/prefix-length>`
`no route <ipv6-addr/prefix-length>`

Parameter	Description
<code><ipv6-addr/prefix-length></code>	Specify the IPv6 Address in format <code>X:X::X:Prefix-Length</code> . The prefix-length is a decimal integer between 1 and 128.

Mode Router Configuration

Usage notes Use this command to add a static RIPng route. After adding the RIPng route, the route can be checked in the RIPng routing table.

Example To configure static RIPng routes, use the following commands:

```
awplus# configure terminal
awplus(config)# router ipv6 rip
awplus(config-router)# route 2001:db8::1/64
```

Related commands [show ipv6 rip](#)
[clear ipv6 rip route](#)

router ipv6 rip

Overview Use this global command to enter Router Configuration mode to enable a RIPng routing process.

Use the **no** variant of this command to disable the RIPng routing process.

Syntax `router ipv6 rip`
`no router ipv6 rip`

Mode Global Configuration

Example To enable a RIPng routing process, use the following commands:

```
awplus# configure terminal
awplus(config)# router ipv6 rip
awplus(config-router)#
```

show debugging ipv6 rip

Overview Use this command to see what debugging is turned on for RIPng options such as: nsm debugging, RIPng event debugging, RIPng packet debugging, and RIPng nsm debugging.

For information on filtering and saving command output, see the [“Getting_Started with AlliedWare Plus” Feature Overview and Configuration_Guide](#).

Syntax `show debugging ipv6 rip`

Mode User Exec and Privileged Exec

Usage notes Use this command to display the debug status of RIPng.

Example To display the RIPng debugging status, use the following command:

```
awplus# show debugging ipv6 rip
```

show ipv6 prefix-list

Overview Use this command to display the prefix-list entries.

Note that this command is valid for RIPng and BGP4+ routing protocols only.

Syntax `show ipv6 prefix-list [<name>|detail|summary]`

Parameter	Description
<code><name></code>	Specify the name of an individual IPv6 prefix list.
<code>detail</code>	Specify this parameter to show detailed output for all IPv6 prefix lists.
<code>summary</code>	Specify this parameter to show summary output for all IPv6 prefix lists.

Mode User Exec and Privileged Exec

Example

```
awplus# show ipv6 prefix-list
awplus# show ipv6 prefix-list 10.10.0.98/8
awplus# show ipv6 prefix-list detail
```

Related commands [ipv6 prefix-list](#)

show ipv6 protocols rip

Overview Use this command to display RIPng process parameters and statistics.

For information on filtering and saving command output, see the [“Getting Started with AlliedWare Plus” Feature Overview and Configuration Guide](#).

Syntax `show ipv6 protocols rip`

Mode User Exec and Privileged Exec

Example To display RIPng process parameters and statistics, use the following command:

```
awplus# show ipv6 protocols rip
```

Output Figure 26-1: Example output from the **show ipv6 protocols rip** command

```
awplus#show ipv6 protocols rip
Routing Protocol is "RIPng"
  Sending updates every 30 seconds with +/-5 seconds, next due
in 6 seconds
  Timeout after 180 seconds, garbage collect after 120 seconds
  Outgoing update filter list for all interface is not set
  Incoming update filter list for all interface is not set
  Default redistribute metric is 1
  Redistributing:
  Interface
    eth1
  Routing for Networks:
    fe80::200:cdff:fe27:c086 vlan1
```

show ipv6 rip

Overview Use this command to show RIPng routes.

For information on filtering and saving command output, see the [“Getting Started with AlliedWare Plus” Feature Overview and Configuration Guide](#).

Syntax `show ipv6 rip`

Mode User Exec and Privileged Exec

Example To display RIPng routes, use the following command:

```
awplus# show ipv6 rip
```

Output Figure 26-2: Example output from the **show ipv6 rip** command

```
awplus#show ipv6 rip
Codes: R - RIP, Rc - RIP connected, Rs - RIP static, Ra - RIP
aggregated, Rcx - RIP connect suppressed, Rsx - RIP static
suppressed, C - Connected, S - Static, O - OSPF, B - BGP

   Network          Next Hop          If      Met Tag   Time
R  2001:db8:1::/48  2001:db8:2::/48  eth1    3    0    02:28
C  2001:db8:3::/48  ::               eth1    1    0
Ra 2001:db8:4::/48  --              --      1    0
...
```

Related commands [show ipv6 rip database](#)

show ipv6 rip database

Overview Use this command to display information about the RIPng database.

For information on filtering and saving command output, see the [“Getting Started with AlliedWare Plus” Feature Overview and Configuration Guide](#).

Syntax `show ipv6 rip database [full]`

Parameter	Description
full	Display all IPv6 RIPng full database entries including sub-optimal routes.

Mode User Exec and Privileged Exec

Example To display information about the RIPng database, use the following command:

```
awplus# show ipv6 rip database
```

Output Figure 26-3: Example output from the **show ipv6 rip database** command

```
Codes: R - RIP, Rc - RIP connected, Rs - RIP static, Ra - RIP
aggregated, Rcx - RIP connect suppressed, Rsx - RIP static
suppressed, C - Connected, S - Static, O - OSPF, B - BGP
```

	Network	Next Hop	If	Met	Tag	Time
R	2001:db8:1::/48	2001:db8:2::/48	eth1	3	0	02:28
C	2001:db8:3::/48	::	eth1	1	0	
Ra	2001:db8:4::/48		--	1	0	
	...					

Related commands [show ipv6 rip](#)

show ipv6 rip interface

Overview Use this command to display information about the RIPng interfaces. You can specify an interface name to display information about a specific interface.

For information on filtering and saving command output, see the [“Getting_Started with AlliedWare Plus” Feature Overview and Configuration_Guide](#).

Syntax `show ipv6 rip interface [<interface>]`

Parameter	Description
<interface>	The interface to display information about.

Mode User Exec and Privileged Exec

Example To display RIPng interface information, use the following command:

```
awplus# show ipv6 rip interface
```

Output Figure 26-4: Example output from the **show ipv6 rip interface** command

```
lo is up, line protocol is up
RIPng is not enabled on this interface
eth1 is up, line protocol is up
Routing Protocol: RIPng
Passive interface: Disabled
Split horizon: Enabled with Poisoned Reversed
IP interface address:
2001:db8:1::1/64
2001:db8:1::2/64
...
```

timers (IPv6 RIPng)

Overview Use this command to adjust the RIPng routing network timers.

Use the **no** variant of this command to restore the defaults.

Syntax `timers basic <update> <timeout> <garbage>`
`no timers basic`

Parameter	Description
<code><update></code>	<code><5-2147483647></code> Specifies the RIPng routing table update timer in seconds. The default is 30 seconds.
<code><timeout></code>	<code><5-2147483647></code> Specifies the RIPng routing information timeout timer in seconds. The default is 180 seconds. After this interval has elapsed and no updates for a route are received, the route is declared invalid.
<code><garbage></code>	<code><5-2147483647></code> Specifies the RIPng routing garbage collection timer in seconds. The default is 120 seconds.

Default The default RIPng routing table update timer default is 30 seconds, the default RIPng routing information timeout timer is 180 seconds, and the default RIPng routing garbage collection timer is 120 seconds. The **no** variant of this command restores the default RIPng routing timers.

Mode Router Configuration

Example To adjust the RIPng routing network timers, use the following commands:

```
awplus# configure terminal
awplus(config)# router ipv6 rip
awplus(config-router)# timers basic 30 180 120
```

undebg ipv6 rip

Overview Use this command to disable debugging options of RIPng events, RIPng packets, and communication between RIPng and NSM processes.

Syntax `undebg ipv6 rip [all|events|nsm|packet [recv|send][detail]]`

Parameter	Description
all	Disables all RIPng debugging.
events	Disable the display of RIPng events information.
nsm	Disable the display of RIPng and NSM communication.
packet	Disable debugging of specified RIPng packets only.
recv	Disable the display of information for received packets.
send	Disable the display of information for sent packets.
detail	Disable the display of detailed information for sent or received packets.

Mode Privileged Exec and Global Configuration

Example To disable debugging options, use the following command:

```
awplus# undebg ipv6 rip events
awplus# undebg ipv6 rip all
awplus# undebg ipv6 rip packet send
awplus# undebg ipv6 rip packet recv detail
```

Related commands [debug ipv6 rip](#)

27

OSPF Commands

Introduction

Overview This chapter provides an alphabetical reference of commands used to configure OSPF. For more information, see the [OSPF Feature Overview and Configuration Guide](#).

- Command List**
- ["area default-cost"](#) on page 1036
 - ["area authentication"](#) on page 1037
 - ["area filter-list"](#) on page 1038
 - ["area nssa"](#) on page 1039
 - ["area range"](#) on page 1041
 - ["area stub"](#) on page 1043
 - ["area virtual-link"](#) on page 1044
 - ["auto-cost reference bandwidth"](#) on page 1047
 - ["bandwidth"](#) on page 1049
 - ["capability opaque"](#) on page 1050
 - ["capability restart"](#) on page 1051
 - ["clear ip ospf process"](#) on page 1052
 - ["compatible rfc1583"](#) on page 1053
 - ["debug ospf events"](#) on page 1054
 - ["debug ospf ifsm"](#) on page 1055
 - ["debug ospf lsa"](#) on page 1056
 - ["debug ospf nfm"](#) on page 1057
 - ["debug ospf nsm"](#) on page 1058
 - ["debug ospf packet"](#) on page 1059

- [“debug ospf route”](#) on page 1060
- [“default-information originate”](#) on page 1061
- [“default-metric \(OSPF\)”](#) on page 1062
- [“distance \(OSPF\)”](#) on page 1063
- [“distribute-list \(OSPF\)”](#) on page 1065
- [“enable db-summary-opt”](#) on page 1067
- [“host area”](#) on page 1068
- [“ip ospf authentication”](#) on page 1069
- [“ip ospf authentication-key”](#) on page 1070
- [“ip ospf cost”](#) on page 1071
- [“ip ospf database-filter”](#) on page 1072
- [“ip ospf dead-interval”](#) on page 1073
- [“ip ospf disable all”](#) on page 1074
- [“ip ospf hello-interval”](#) on page 1075
- [“ip ospf message-digest-key”](#) on page 1076
- [“ip ospf mtu”](#) on page 1078
- [“ip ospf mtu-ignore”](#) on page 1079
- [“ip ospf network”](#) on page 1080
- [“ip ospf priority”](#) on page 1081
- [“ip ospf resync-timeout”](#) on page 1082
- [“ip ospf retransmit-interval”](#) on page 1083
- [“ip ospf transmit-delay”](#) on page 1084
- [“max-concurrent-dd”](#) on page 1085
- [“maximum-area”](#) on page 1086
- [“neighbor \(OSPF\)”](#) on page 1087
- [“network area”](#) on page 1088
- [“ospf abr-type”](#) on page 1090
- [“ospf restart grace-period”](#) on page 1091
- [“ospf restart helper”](#) on page 1092
- [“ospf router-id”](#) on page 1094
- [“overflow database”](#) on page 1095
- [“overflow database external”](#) on page 1096
- [“passive-interface \(OSPF\)”](#) on page 1097
- [“redistribute \(OSPF\)”](#) on page 1098
- [“restart ospf graceful”](#) on page 1100

- ["router ospf"](#) on page 1101
- ["router-id"](#) on page 1103
- ["show debugging ospf"](#) on page 1104
- ["show ip ospf"](#) on page 1105
- ["show ip ospf border-routers"](#) on page 1108
- ["show ip ospf database"](#) on page 1109
- ["show ip ospf database asbr-summary"](#) on page 1111
- ["show ip ospf database external"](#) on page 1112
- ["show ip ospf database network"](#) on page 1114
- ["show ip ospf database nssa-external"](#) on page 1115
- ["show ip ospf database opaque-area"](#) on page 1117
- ["show ip ospf database opaque-as"](#) on page 1118
- ["show ip ospf database opaque-link"](#) on page 1119
- ["show ip ospf database router"](#) on page 1120
- ["show ip ospf database summary"](#) on page 1122
- ["show ip ospf interface"](#) on page 1125
- ["show ip ospf neighbor"](#) on page 1126
- ["show ip ospf route"](#) on page 1128
- ["show ip ospf virtual-links"](#) on page 1129
- ["show ip protocols ospf"](#) on page 1130
- ["summary-address"](#) on page 1131
- ["timers spf exp"](#) on page 1132
- ["undebug ospf events"](#) on page 1133
- ["undebug ospf ifsm"](#) on page 1134
- ["undebug ospf lsa"](#) on page 1135
- ["undebug ospf nfm"](#) on page 1136
- ["undebug ospf nsm"](#) on page 1137
- ["undebug ospf packet"](#) on page 1138
- ["undebug ospf route"](#) on page 1139

area default-cost

Overview This command specifies a cost for the default summary route sent into a stub or NSSA area.

The **no** variant of this command removes the assigned default-route cost.

Syntax `area <area-id> default-cost <0-16777215>`
`no area <area-id> default-cost`

Parameter	Description
<code><area-id></code>	The OSPF area that you are specifying the default summary route cost for. Use one of the following formats: This can be entered in either dotted decimal format or normal decimal format.
<code><ip-addr></code>	OSPF Area ID expressed in IPv4 address format A.B.C.D.
<code><0-4294967295></code>	OSPF Area ID expressed as a decimal number within the range shown.
	For example the values dotted decimal 0.0.1.2 and decimal 258 would both define the same area ID.
<code>default-cost</code>	Indicates the cost for the default summary route used for a stub or NSSA area. Default: 1

Mode Router Configuration

Usage The default-cost option provides the metric for the summary default route, generated by the area border router, into the NSSA or stub area. Use this option only on an area border router that is attached to the NSSA or stub area. Refer to the RFC 3101 for information on NSSA.

Example To set the default cost to 10 in area 1 for the OSPF instance 100, use the commands:

```
awplus# configure terminal
awplus(config)# router ospf 100
awplus(config-router)# area 1 default-cost 10
```

Related commands [area nssa](#)
[area stub](#)

area authentication

Overview Use this command to enable authentication for an OSPF area. Specifying the area authentication sets the authentication to Type 1 authentication or the Simple Text password authentication (details in RFC 2328).

The **no** variant of this command removes the authentication specification for an area.

Syntax `area <area-id> authentication [message-digest]`
`no area <area-id> authentication`

Parameter	Description
<code><area-id></code>	The OSPF area that you are enabling authentication for. This can be entered in either dotted decimal format or normal decimal format.
<code><ip-addr></code>	OSPF Area ID expressed in IPv4 address, entered in the form A.B.C.D.
<code><0-4294967295></code>	OSPF Area ID expressed as a decimal number within the range shown.
	For example the values dotted decimal 0.0.1.2 and decimal 258 would both define the same area OSPF Area ID.
<code>message-digest</code>	Enables MD5 authentication in the OSPF area.

Default By default, no authentication occurs.

Mode Router Configuration

Usage All OSPF packets transmitted in this **area** must have the same password in their OSPF header. This ensures that only routers that have the correct password may join the routing domain.

Give all routers that are to communicate with each other through OSPF the same authentication password.

Use the [ip ospf authentication-key](#) command to specify a Simple Text password. Use the [ip ospf message-digest-key](#) command to specify MD5 password.

Example

```
awplus# configure terminal
awplus(config)# router ospf 100
awplus(config-router)# area 1 authentication
```

Related commands [ip ospf authentication](#)
[ip ospf message-digest-key](#)

area filter-list

Overview This command configures filters to advertise summary routes on Area Border Routers (ABR).

This command is used to suppress particular intra-area routes from/to an area to/from the other areas. You can use this command in conjunction with the prefix-list command.

The **no** variant of this command removes the filter configuration.

Syntax `area <area-id> filter-list prefix <prefix-list> {in|out}`
`no area <area-id> filter-list prefix <prefix-list> {in|out}`

Parameter	Description
<code><area-id></code>	The OSPF area that you are configuring the filter for. Use one of the following formats: This can be entered in either dotted decimal format or normal decimal format.
	<code><ip-addr></code> OSPF Area ID expressed in IPv4 address format A.B.C.D.
	<code><0-4294967295></code> OSPF Area ID expressed as a decimal number within the range shown.
	For example the values dotted decimal 0.0.1.2 and decimal 258 would both define the same area ID.
<code>prefix</code>	Use prefix-list to filter summary.
<code><prefix-list></code>	Name of a prefix-list.
<code>in</code>	Filter routes from the other areas to this area.
<code>out</code>	Filter routes from this area to the other areas.

Mode Router Configuration

area nssa

Overview This command sets an area as a Not-So-Stubby-Area (NSSA). By default, no NSSA area is defined.

Use this command to simplify administration if you are connecting a central site using OSPF to a remote site that is using a different routing protocol. You can extend OSPF to cover the remote connection by defining the area between the central router and the remote router as an NSSA.

There are no external routes in an OSPF stub area, so you cannot redistribute from another protocol into a stub area. A NSSA allows external routes to be flooded within the area. These routes are then leaked into other areas. Although, the external routes from other areas still do not enter the NSSA. You can either configure an area to be a stub area or an NSSA, not both.

The **no** variant of this command removes this designation.

Syntax

```
area <area-id> nssa [default-information-originate <metric> |
no-redistribution | no-summary | translator-role <role> ]
no area <area-id> nssa [default-information-originate |
no-redistribution | no-summary | translator-role ]
```

Parameter	Description				
<area-id>	The OSPF area that you are configuring as an NSSA. Use one of the following formats: This can be entered in either dotted decimal format or normal decimal format. <table border="1"> <tr> <td><ip-addr></td> <td>OSPF Area ID expressed in IPv4 address format A.B.C.D.</td> </tr> <tr> <td><0-4294967295></td> <td>OSPF Area ID expressed as a decimal number within the range shown.</td> </tr> </table> For example the values dotted decimal 0.0.1.2 and decimal 258 would both define the same area ID.	<ip-addr>	OSPF Area ID expressed in IPv4 address format A.B.C.D.	<0-4294967295>	OSPF Area ID expressed as a decimal number within the range shown.
<ip-addr>	OSPF Area ID expressed in IPv4 address format A.B.C.D.				
<0-4294967295>	OSPF Area ID expressed as a decimal number within the range shown.				
default-information-originate	Originate Type-7 default LSA into NSSA.				
<metric>	The external or internal metric. Specify the following: <table border="1"> <tr> <td>metric<0-16777214></td> <td>The metric value.</td> </tr> <tr> <td>metric-type<1-2></td> <td>External metric type.</td> </tr> </table>	metric<0-16777214>	The metric value.	metric-type<1-2>	External metric type.
metric<0-16777214>	The metric value.				
metric-type<1-2>	External metric type.				
no-redistribution	Do not redistribute external route into NSSA.				
no-summary	Do not inject inter-area route into NSSA.				
translator-role	Specify NSSA-ABR translator-role.				

Parameter	Description
<code><role></code>	The role type. Specify one of the following keywords:
<code>always</code>	Router always translate NSSA-LSA to Type-5 LSA.
<code>candidate</code>	Router may translate NSSA-LSA to Type-5 LSA if it is elected.
<code>never</code>	Router never translate NSSA-LSA.

Mode Router Configuration

Example

```
awplus# configure terminal
awplus(config)# router ospf 100
awplus(config-router)# area 0.0.0.51 nssa
awplus(config-router)# area 3 nssa translator-role candidate
no-redistribution default-information-originate metric 34
metric-type 2
```

Related commands [area default-cost](#)

area range

Overview Use this command to summarize OSPF routes at an area boundary, configuring an IPv4 address range which consolidates OSPF routes. By default, this feature is not enabled.

A summary route created by this command is then advertised to other areas by the Area Border Routers (ABRs). In this way, routing information is condensed at area boundaries and outside the area so that routes are exchanged between areas in an efficient manner.

If the network numbers in an area are arranged into sets of contiguous routes, the ABRs can be configured to advertise a summary route that covers all the individual networks within the area that fall into the specified range.

Use the cost parameter to specify a metric that will be advertised in the summary Link State Advertisement (LSA), rather than relying on the standard method to calculate the metric for the LSA.

The **no** variant of this command disables this function and restores default behavior.

Syntax `area <area-id> range <ip-addr/prefix-length> [advertise] [cost <0-16777215>]`

`area <area-id> range <ip-addr/prefix-length> not-advertise`

`no area <area-id> range <ip-addr/prefix-length>`

Parameter	Description
<code><area-id></code>	The OSPF area that you summarizing the routes for. Use one of the following formats: This can be entered in either dotted decimal format or normal decimal format.
<code><ip-addr></code>	OSPF Area ID expressed in IPv4 address format A.B.C.D.
<code><0-4294967295></code>	OSPF Area ID expressed as a decimal number within the range shown.
	For example the values dotted decimal 0.0.1.2 and decimal 258 would both define the same area ID.
<code><ip-addr/prefix-length></code>	The area range prefix and length.
<code>advertise</code>	Advertise this range as a summary route into other areas.

Parameter	Description
not-advertise	Does not advertise this range.
cost	Optionally override the metric that would normally be calculated for this summary with a user-defined cost to be advertised for this summary LSA. Specify the metric to be advertised for this route in the range 0-16777215.

Default The area range is not configured by default. The area range is advertised if it is configured.

Mode Router Configuration

Usage notes You can configure multiple ranges on a single area with multiple instances of this command, so OSPF summarizes addresses for different sets of IPv4 address ranges. Ensure OSPF IPv4 routes exist in the area range for advertisement before using this command.

Example

```
awplus# configure terminal
awplus(config)# router ospf 100
awplus(config-router)# area 1 range 192.16.0.0/16
awplus(config-router)# area 1 range 203.18.0.0/16 cost 70
```

To remove a cost configured on an area range, re-enter the area range without the optional cost parameter. This will set the metric calculation back to the default algorithm.

```
awplus(config-router)# area 1 range 207.14.0.0/16 cost 35
awplus(config-router)# area 1 range 207.14.0.0/16
```

Command changes Version 5.5.0-0.1: parameter **cost** added

area stub

Overview This command defines an OSPF area as a stub area. By default, no stub area is defined.

Use this command when routers in the area do not require learning about summary LSAs from other areas. You can define the area as a totally stubby area by configuring the Area Border Router of that area using the **area stub no-summary** command.

There are two stub area router configuration commands: the **area stub** and **area default-cost** commands. In all routers attached to the stub area, configure the area by using the **area stub** command. For an area border router (ABR) attached to the stub area, also use the **area default-cost** command.

The **no** variant of this command removes this definition.

Syntax `area <area-id> stub [no-summary]`
`no area <area-id> stub [no-summary]`

Parameter	Description
<code><area-id></code>	The OSPF area that you are configuring as a stub area. Use one of the following formats: This can be entered in either dotted decimal format or normal decimal format. For example the values dotted decimal 0.0.1.2 and decimal 258 would both define the same area ID.
<code><ip-addr></code>	OSPF Area ID expressed in IPv4 address in the format A.B.C.D.
<code><0-4294967295></code>	OSPF Area ID expressed as a decimal number within the range shown.
	For example the values dotted decimal 0.0.1.2 and decimal 258 would both define the same area ID.
<code>no-summary</code>	Stops an ABR from sending summary link advertisements into the stub area.

Mode Router Configuration

Example `awplus# configure terminal`
`awplus(config)# router ospf 100`
`awplus(config-router)# area 1 stub`

Related commands [area default-cost](#)

area virtual-link

Overview This command configures a link between two backbone areas that are physically separated through other non-backbone areas.

In OSPF, all non-backbone areas must be connected to a backbone area. If the connection to the backbone is lost, the virtual link repairs the connection.

The **no** variant of this command removes the virtual link.

Syntax

```

area <area-id> virtual-link <ip-addr> [<auth-key>|<msg-key>]
no area <area-id> virtual-link <ip-addr> [<auth-key>|<msg-key>]

area <area-id> virtual-link <ip-addr> authentication
[message-digest|null] [<auth-key>|<msg-key>]

no area <area-id> virtual-link <ip-addr> authentication
[message-digest|null] [<auth-key>|<msg-key>]

area <area-id> virtual-link <ip-addr> [authentication]
[dead-interval <1-65535>] [hello-interval <1-65535>]
[retransmit-interval <1-3600>] [transmit-delay <1-3600>]

no area <area-id> virtual-link <ip-addr> [authentication]
[dead-interval] [hello-interval] [retransmit-interval]
[transmit-delay]

```

Parameter	Description
<area-id>	The area ID of the transit area that the virtual link passes through. Use one of the following formats: This can be entered in either dotted decimal format or normal decimal format.
<ip-addr>	OSPF Area ID expressed in IPv4 address format A.B.C.D.
<0-4294967295>	OSPF Area ID expressed as a decimal number within the range shown.
	For example the values dotted decimal 0.0.1.2 and decimal 258 would both define the same area ID.
<ip-addr>	The OSPF router ID of the virtual link neighbor.
<auth-key>	Specifies the password used for this virtual link. Use the format: authentication-key <pswd-short>
<pswd-short>	An 8 character password.
<msg-key>	Specifies a message digest key using the MD5 encryption algorithm. Use the following format: message-digest-key <1-255> md5 <pswd-long>
<1-255>	The key ID.
<pswd-long>	Authentication password of 16 characters.
authentication	Enables authentication on this virtual link.

Parameter	Description
message-digest	Use message-digest authentication.
null	Use null authentication to override password or message digest.
dead-interval	If no packets are received from a particular neighbor for dead-interval seconds, the router considers that neighboring router as being off-line. Default: 40 seconds
	<1-65535> The number of seconds in the interval.
hello-interval	The interval the router waits before it sends a hello packet. Default: 10 seconds
	<1-65535> The number of seconds in the interval.
retransmit-interval	The interval the router waits before it retransmits a packet. Default: 5 seconds
	<1-3600> The number of seconds in the interval.
transmit-delay	The interval the router waits before it transmits a packet. Default: 1 seconds
	<1-3600> The number of seconds in the interval.

Mode Router Configuration

Usage notes You can configure virtual links between any two backbone routers that have an interface to a common non-backbone area. The protocol treats these two routers, joined by a virtual link, as if they were connected by an unnumbered point-to-point network. To configure a virtual link, you require:

- The transit area ID, i.e. the area ID of the non backbone area that the two backbone routers are both connected to.
- The corresponding virtual link neighbor's router ID. To see the router ID use the [show ip ospf](#) command.

Configure the **hello-interval** to be the same for all routers attached to a common network. A short **hello-interval** results in the router detecting topological changes faster but also an increase in the routing traffic.

The **retransmit-interval** is the expected round-trip delay between any two routers in a network. Set the value to be greater than the expected round-trip delay to avoid needless retransmissions.

The **transmit-delay** is the time taken to transmit a link state update packet on the interface. Before transmission, the link state advertisements in the update packet are incremented by this amount. Set the **transmit-delay** to be greater than zero. Also, take into account the transmission and propagation delays for the interface.

Example To configure a virtual link, use the commands:

```
awplus# configure terminal
awplus(config)# router ospf 100
awplus(config-router)# area 1 virtual-link 10.10.11.50
hello-interval 5 dead-interval 10
```

Related commands

- area authentication
- show ip ospf
- show ip ospf virtual-links

auto-cost reference bandwidth

Overview This command controls how OSPF calculates default metrics for the interface. Use the **no** variant of this command to assign cost based only on the interface bandwidth.

Syntax `auto-cost reference-bandwidth <1-4294967>`
`no auto-cost reference-bandwidth`

Parameter	Description
<code><1-4294967></code>	The reference bandwidth in terms of Mbits per second (Mbps).

Default 1000 Mbps

Usage notes By default, OSPF calculates the OSPF metric for an interface by dividing the reference bandwidth by the interface bandwidth. The default for the reference bandwidth is 1000 Mbps. As a result, if this default is used, there is very little difference between the metrics applied to interfaces of increasing bandwidth beyond 1000 Mbps.

The auto-cost command is used to alter this reference bandwidth in order to give a real difference between the metrics of high bandwidth links of differing bandwidths. In a network that has multiple links with high bandwidths, specify a larger reference bandwidth value to differentiate the costs on those links.

Cost is calculated by dividing the reference bandwidth (Mbps) by the layer 3 interface (Switched Virtual Interface (SVI), Loopback or Ethernet interface) bandwidth. Interface bandwidth may be altered by using the [bandwidth](#) command as the SVI does not auto detect the bandwidth based on the speed of associated switch ports.

When the reference bandwidth calculation results in a cost integer greater than 1 but contains a fractional value (value after the decimal point), the result rounds down to the nearest integer. The following example shows how the cost is calculated.

The reference bandwidth is 1000 Mbps and the interface bandwidth is 7 Mbps.

Calculation = $1000/7$

Calculation result = 142.85 (integer of 142, fractional value of 0.85)

Result after rounding down to the nearest integer = 142 (Interface cost is 142)

When the reference bandwidth calculation results in a cost less than 1, it is rounded up to the nearest integer which is 1. The following example shows how the cost is calculated.

The reference bandwidth is 1000 Mbps and the interface bandwidth is 10000 Mbps.

Calculation = $1000/10000$

Calculation result = 0.1

Result after rounding up to the nearest integer = 1 (Interface cost is 1)

The auto-cost reference bandwidth value should be consistent across all OSPF routers in the OSPF process.

Note that using the [ip ospf cost](#) command on a layer 3 interface will override the cost calculated by this command.

Mode Router Configuration

Example

```
awplus# configure terminal
awplus(config)# router ospf 100
awplus(config-router)# auto-cost reference-bandwidth 1000
```

Related commands [ip ospf cost](#)

bandwidth

Overview Use this command to specify the maximum bandwidth to be used for each interface. The bandwidth value is in bits per second. OSPF uses this to calculate metrics for the interface.

The **no** variant of this command removes any applied bandwidth value.

Syntax `bandwidth <bandwidth-setting>`
`no bandwidth`

Parameter	Description
<code><bandwidth-setting></code>	Sets the bandwidth for the interface. Enter a value in the range 1 to 10000000000 bits per second. Note that to avoid entering many zeros, you can add k, m, or g to internally add 3, 6 or 9 zeros to the number entered. For example entering 1k is the same as entering 1000.

Mode Interface Configuration for a VLAN interface, an Eth interface, an 802.1Q sub-interface, a PPP interface, a bridge, or a tunnel.

Example To set the bandwidth on VLAN2 to be 10 Mbps, use the following commands:

```
awplus# configure terminal
awplus(config)# interface vlan2
awplus(config-if)# bandwidth 10000000
or
awplus(config-if)# bandwidth 10m
```

Related commands [show interface](#)

capability opaque

Overview This command enables opaque-LSAs. Opaque-LSAs are Type 9, 10 and 11 LSAs that deliver information used by external applications.

Use the **no** variant of this command to disable opaque-LSAs.

Syntax `capability opaque`
`no capability opaque`

Default By default, opaque-LSAs are enabled.

Mode Router Configuration

Example

```
awplus# configure terminal
awplus(config)# router ospf 100
awplus(config-router)# no capability opaque
```

capability restart

Overview This command enables OSPF Graceful Restart or restart signaling features. By default, this is enabled.

Use the **no** variant of this command to disable OSPF Graceful Restart and restart signaling features.

Syntax `capability restart [graceful|signaling]`
`no capability restart`

Parameter	Description
<code>graceful</code>	Enable graceful OSPF restart.
<code>signaling</code>	Enable OSPF restart signaling.

Default Graceful restart

Mode Router Configuration

Example `awplus# configure terminal`
`awplus(config)# router ospf 100`
`awplus(config-router)# capability restart graceful`

clear ip ospf process

Overview This command clears and restarts the OSPF routing process. Specify the Process ID to clear one particular OSPF process. When no Process ID is specified, this command clears all running OSPF processes.

Syntax `clear ip ospf [<0-65535>] process`

Parameter	Description
<0-65535>	The Routing Process ID.

Mode Privileged Exec

Example `awplus# clear ip ospf process`

compatible rfc1583

Overview This command changes the method used to calculate summary route to the that specified in RFC 1583. By default, OSPF uses the method specified in RFC 2328.

RFC 1583 specifies a method for calculating the metric for summary routes based on the minimum metric of the component paths available. RFC 2328 specifies a method for calculating metrics based on maximum cost.

It is possible that some ABRs in an area might conform to RFC 1583 and others support RFC 2328, which could lead to incompatibility in their interoperation. This command addresses this issue by allowing you to selectively disable compatibility with RFC 2328.

Use the **no** variant of this command to disable RFC 1583 compatibility.

Syntax compatible rfc1583
no compatible rfc1583

Mode Router Configuration

Example awplus# configure terminal
awplus(config)# router ospf 100
awplus(config-router)# compatible rfc1583

debug ospf events

Overview This command enables OSPF debugging for OSPF event troubleshooting.

To enable all debugging options, specify **debug ospf event** with no additional parameters.

The **no** and **undebug** variant of this command disable OSPF debugging. Use this command without parameters to disable all the options.

Syntax

```
debug ospf events [abr] [asbr] [lsa] [nssa] [os] [router] [vlink]
no debug ospf events [abr] [asbr] [lsa] [nssa] [os] [router] [vlink]
```

Parameter	Description
abr	Shows ABR events.
asbr	Shows ASBR events.
lsa	Shows LSA events.
nssa	Shows NSSA events.
os	Shows OS interaction events.
router	Shows other router events.
vlink	Shows virtual link events.

Mode Privileged Exec and Global Configuration

Example awplus# debug ospf events asbr lsa

Related commands [terminal monitor](#)
[undebug ospf events](#)

debug ospf ifsm

Overview This command specifies debugging options for OSPF Interface Finite State Machine (IFSM) troubleshooting.

To enable all debugging options, specify **debug ospf ifsm** with no additional parameters.

The **no** and **undebug** variant of this command disable OSPF IFSM debugging. Use this command without parameters to disable all the options.

Syntax `debug ospf ifsm [status] [events] [timers]`
`no debug ospf ifsm [status] [events] [timers]`

Parameter	Description
events	Displays IFSM event information.
status	Displays IFSM status information.
timers	Displays IFSM timer information.

Mode Privileged Exec and Global Configuration

Example `awplus# no debug ospf ifsm events status`
`awplus# debug ospf ifsm status`
`awplus# debug ospf ifsm timers`

Related commands [terminal monitor](#)
[undebug ospf ifsm](#)

debug ospf lsa

Overview This command enables debugging options for OSPF Link State Advertisements (LSA) troubleshooting. This displays information related to internal operations of LSAs.

To enable all debugging options, specify **debug ospf lsa** with no additional parameters.

The **no** and **undebug** variant of this command disable OSPF LSA debugging. Use this command without parameters to disable all the options.

Syntax

```
debug ospf lsa [flooding] [generate] [install] [maxage] [refresh]
no debug ospf lsa [flooding] [generate] [install] [maxage] [refresh]
```

Parameter	Description
flooding	Displays LSA flooding.
generate	Displays LSA generation.
install	Show LSA installation.
maxage	Shows maximum age of the LSA in seconds.
refresh	Displays LSA refresh.

Mode Privileged Exec and Global Configuration

Examples awplus# undebug ospf lsa refresh

Output Figure 27-1: Example output from the **debug ospf lsa** command

```
2002/05/09 14:08:11 OSPF: LSA[10.10.10.10:10.10.10.70]: instance(0x8139cd0)
created with Link State Update
2002/05/09 14:08:11 OSPF: RECV[LS-Upd]: From 10.10.10.70 via vlan5:10.10.10.50
(10.10.10.10 -> 224.0.0.5)
2002/05/09 14:12:33 OSPF: SEND[LS-Upd]: Begin send queue
2002/05/09 14:12:33 OSPF: SEND[LS-Upd]: # of LSAs 1, destination 224.0.0.5
2002/05/09 14:12:33 OSPF: SEND[LS-Upd]: End send queue
2002/05/09 14:12:33 OSPF: SEND[LS-Upd]: To 224.0.0.5 via vlan5:10.10.10.50
```

Related commands [terminal monitor](#)
[undebug ospf lsa](#)

debug ospf nfsm

Overview This command enables debugging options for OSPF Neighbor Finite State Machines (NFSMs).

To enable all debugging options, specify **debug ospf nfsm** with no additional parameters.

The **no** and **undebug** variant of this command disable OSPF NFSM debugging. Use this command without parameters to disable all the options.

Syntax `debug ospf nfsm [events] [status] [timers]`
`no debug ospf nfsm [events] [status] [timers]`

Parameter	Description
events	Displays NFSM event information.
status	Displays NFSM status information.
timers	Displays NFSM timer information.

Mode Privileged Exec and Global Configuration

Examples `awplus# debug ospf nfsm events`
`awplus# no debug ospf nfsm timers`
`awplus# undebug ospf nfsm events`

Related commands [terminal monitor](#)
[undebug ospf nfsm](#)

debug ospf nsm

Overview This command enables debugging options for the OSPF Network Service Module. To enable both debugging options, specify **debug ospf nsm** with no additional parameters. The **no** and **undebug** variant of this command disable OSPF NSM debugging. Use this command without parameters to disable both options.

Syntax `debug ospf nsm [interface] [redistribute]`
`no debug ospf nsm [interface] [redistribute]`

Parameter	Description
interface	Specify NSM interface information.
redistribute	Specify NSM redistribute information.

Mode Privileged Exec and Global Configuration

Examples `awplus# debug ospf nsm interface`
`awplus# no debug ospf nsm redistribute`
`awplus# undebug ospf nsm interface`

Related commands [terminal monitor](#)
[undebug ospf nsm](#)

debug ospf packet

Overview This command enables debugging options for OSPF packets.

To enable all debugging options, specify **debug ospf packet** with no additional parameters.

The **no** and **undebug** variant of this command disable OSPF packet debugging. Use this command without parameters to disable all options.

Syntax `debug ospf packet [dd] [detail] [hello] [ls-ack] [ls-request] [ls-update] [recv] [send]`
`no debug ospf packet [dd] [detail] [hello] [ls-ack] [ls-request] [ls-update] [recv] [send]`

Parameter	Description
dd	Specifies debugging for OSPF database descriptions.
detail	Sets the debug option to detailed information.
hello	Specifies debugging for OSPF hello packets.
ls-ack	Specifies debugging for OSPF link state acknowledgments.
ls-request	Specifies debugging for OSPF link state requests.
ls-update	Specifies debugging for OSPF link state updates.
recv	Specifies the debug option set for received packets.
send	Specifies the debug option set for sent packets.

Mode Privileged Exec and Global Configuration

Examples `awplus# debug ospf packet detail`
`awplus# debug ospf packet dd send detail`
`awplus# no debug ospf packet ls-request recv detail`
`awplus# undebug ospf packet ls-request recv detail`

Related commands [terminal monitor](#)
[undebug ospf packet](#)

debug ospf route

Overview This command enables debugging of route calculation. Use this command without parameters to turn on all the options.

To enable all debugging options, specify **debug ospf route** with no additional parameters.

The **no** and **undebug** variant of this command disable OSPF route debugging. Use this command without parameters to disable all options.

Syntax `debug ospf route [ase] [ia] [install] [spf]`
`no debug ospf route [ase] [ia] [install] [spf]`

Parameter	Description
ia	Specifies the debugging of Inter-Area route calculation.
ase	Specifies the debugging of external route calculation.
install	Specifies the debugging of route installation.
spf	Specifies the debugging of SPF calculation.

Mode Privileged Exec and Global Configuration

Examples `awplus# debug ospf route`
`awplus# no debug ospf route ia`
`awplus# debug ospf route install`
`awplus# undebug ospf route install`

Related commands [terminal monitor](#)
[undebug ospf route](#)

default-information originate

Overview This command creates a default external route into an OSPF routing domain.

When you use the **default-information originate** command to redistribute routes into an OSPF routing domain, then the system acts like an Autonomous System Boundary Router (ASBR). By default, an ASBR does not generate a default route into the OSPF routing domain.

When using this command, also specify the **route-map** *<route-map>* option to avoid a dependency on the default network in the routing table.

The **metric-type** is an external link type associated with the default route advertised into the OSPF routing domain. The value of the external route could be either Type 1 or 2. The default is Type 2.

The **no** variant of this command disables this feature.

Syntax

```
default-information originate [always] [metric <metric>]
[metric-type <1-2>] [route-map <route-map>]

no default-information originate [always] [metric]
[metric-type] [route-map]
```

Parameter	Description
always	Used to advertise the default route regardless of whether there is a default route.
<metric>	The metric value used in creating the default route. Enter a value in the range 0 to 16777214. The default metric value is 10. The value used is specific to the protocol.
<1-2>	External metric type for default routes, either OSPF External Type 1 or Type 2 metrics. Enter the value 1 or 2.
route-map	Specifies to use a specific route-map.
<route-map>	The route-map name. It is a string comprised of any characters, numbers or symbols.

Mode Router Configuration

Example

```
awplus# configure terminal
awplus(config)# router ospf 100
awplus(config-router)# default-information originate always
metric 23 metric-type 2 route-map myinfo
```

Related commands [route-map](#)

default-metric (OSPF)

Overview This command sets default metric values for the OSPF routing protocol. The **no** variant of this command returns OSPF to using built-in, automatic metric translations, as appropriate for each routing protocol.

Syntax `default-metric <1-16777214>`
`no default-metric [<1-16777214>]`

Parameter	Description
<code><1-16777214></code>	Default metric value appropriate for the specified routing protocol.

Mode Router Configuration

Usage notes A default metric facilitates redistributing routes even with incompatible metrics. If the metrics do not convert, the default metric provides an alternative and enables the redistribution to continue. The effect of this command is that OSPF will use the same metric value for **all** redistributed routes. Use this command in conjunction with the [redistribute \(OSPF\)](#) command.

Examples

```
awplus# configure terminal
awplus(config)# router ospf 100
awplus(config-router)# default-metric 100
awplus# configure terminal
awplus(config)# router ospf 100
awplus(config-router)# no default-metric
```

Related commands [redistribute \(OSPF\)](#)

distance (OSPF)

Overview This command sets the administrative distance for OSPF routes based on the route type. Your device uses this value to select between two or more routes to the same destination from two different routing protocols. The route with the smallest administrative distance value is added to the Forwarding Information Base (FIB). See the [Route_Selection Feature Overview and Configuration Guide](#) for more information.

Use the command **distance ospf** to set the distance for an entire category of OSPF routes, rather than the specific routes that pass an access list.

Use the command **distance <1-255>**, with no other parameter, to set the same distance for all OSPF route types.

The **no** variant of this command sets the administrative distance for all OSPF routes to the default of 110.

Syntax

```
distance <1-255>
distance ospf {external <1-255>|inter-area <1-255>|intra-area <1-255>}
no distance {ospf|<1-255>}
```

Parameter	Description
<1-255>	Specify the Administrative Distance value for OSPF routes.
external	Sets the distance for routes from other routing domains, learned by redistribution. Specify an OSPF external distance in the range <1-255>.
inter-area	Sets the distance for all routes from one area to another area. Specify an OSPF inter-area distance in the range <1-255>.
intra-area	Sets the distance for all routes within an area. Specify an OSPF intra-area distance in the range <1-255>.

Default The default OSPF administrative distance is 110. The default Administrative Distance for each type of route (intra, inter, or external) is 110.

Mode Router Configuration

Usage notes The administrative distance rates the trustworthiness of a routing information source. The distance could be any integer from 0 to 255. A higher distance value indicates a lower trust rating. For example, an administrative distance of 255 indicates that the routing information source cannot be trusted and should be ignored.

Use this command to set the distance for an entire group of routes, rather than a specific route that passes an access list.

Examples To set the following administrative distances for route types in OSPF 100:

- 20 for inter-area routes

- 10 for intra-area routes
- 40 for external routes

use the commands:

```
awplus(config)# router ospf 100
awplus(config-router)# distance ospf inter-area 20 intra-area
10 external 40
```

To set the administrative distance for all routes in OSPF 100 back to the default of 110, use the commands:

```
awplus(config)# router ospf 100
awplus(config-router)# no distance ospf
```

distribute-list (OSPF)

Overview Use this command to apply filtering to the transfer of routing information between OSPF and the IP route table. You can apply filtering from OSPF to the IP route table using an **in** distribute-list.

The effect of an **in** filter is that some route information that OSPF has learned from LSA updates will not be installed into the IP route table.

The entities that are used to perform filtering are route-maps, which match on certain attributes in the routes that are being transferred.

For information about route maps, see the [Routemaps Feature Overview and Configuration Guide](#).

The **no** variant of this command removes the configured distribute-list command entry.

Syntax `distribute-list route-map <route-map-name> in`
`no distribute-list route-map <route-map-name> in`

Parameter	Description
<code><route-map-name></code>	The name of the route-map.
<code>in</code>	Indicates that this applies to incoming advertised routes.

Mode Router Configuration

Usage notes The **in** distribute-lists carry out the following route filtering activities:

- The **in** distribute list is applied to the process of installing OSPF routes into the IP route table. The SPF calculations generate a set of routes calculated from the LSA database. By default, all of these routes become OSPF's candidate routes for inclusion into the IP route table.
- An **in** distribute-list can be used to control whether or not certain routes generated by the SPF calculation are included into the set of candidates for inclusion into the IP route table. Those routes that match **deny** entries in the distribute-list will not be considered for inclusion into the IP route table.

Examples The following example shows the installation of OSPF routes into the IP route table with route map "mymap1" applied, which will process routes that have been tagged 100:

```
awplus# configure terminal
awplus(config)# route-map mymap1 permit 10
awplus(config-route-map)# match tag 100
awplus(config-route-map)# exit
awplus(config)# router ospf 100
awplus(config-router)# distribute-list route-map mymap1 in
```

Use the following commands to configure a route-map to specifically prevent OSPF from offering 192.168.1.0/24 as a candidate for inclusion into the IP route table:

```
awplus# configure terminal
awplus(config)# ip prefix-list 100 seq 5 permit 192.168.1.0/24
awplus(config)# route-map 100 deny 10
awplus(config-route-map)# match ip address prefix-list 100
awplus(config-route-map)# exit
awplus(config)# route-map 100 permit 20
awplus(config-router)# router ospf 1
awplus(config-router)# distribute-list route-map 100 in
```

Related commands

- [match interface](#)
- [redistribute \(OSPF\)](#)
- [route-map](#)

enable db-summary-opt

Overview This command enables OSPF database summary list optimization.
The **no** variant of this command disables database summary list optimization.

Syntax `enable db-summary-opt`
`no enable db-summary-opt`

Default The default setting is disabled.

Mode Router Configuration

Usage When this feature is enabled, the database exchange process is optimized by removing the LSA from the database summary list for the neighbor, if the LSA instance in the database summary list is the same as, or less recent than, the listed LSA in the database description packet received from the neighbor.

Examples To enable OSPF database summary list optimization, use the commands:

```
awplus# configure terminal
awplus(config)# router ospf
awplus(config-router)# enable db-summary-opt
```

To disable OSPF database summary list optimization, use the commands:

```
awplus# configure terminal
awplus(config)# router ospf
awplus(config-router)# no enable db-summary-opt
```

**Validation
Commands** `show running-config`

host area

Overview This command configures a stub host entry belonging to a particular area. You can use this command to advertise specific host routes in the router-LSA as stub link. Since stub host belongs to the specified router, specifying cost is optional.

The **no** variant of this command removes the host area configuration.

Syntax `host <ip-address> area <area-id> [cost <0-65535>]`
`no host <ip-address> area <area-id> [cost <0-65535>]`

Parameter	Description
<code><ip-address></code>	The IPv4 address of the host, in dotted decimal notation.
<code><area-id></code>	The OSPF area ID of the transit area that configuring the stub host entry for. Use one of the following formats: <ul style="list-style-type: none">dotted decimal format, e.g. 0.0.1.2.normal decimal format in the range <0-4294967295>, e.g. 258.
<code>cost <0-65535></code>	The cost for the stub host entry.

Default By default, no host entry is configured.

Mode Router Configuration

Example

```
awplus# configure terminal
awplus(config)# router ospf 100
awplus(config-router)# host 172.16.10.100 area 1
awplus(config-router)# host 172.16.10.101 area 2 cost 10
```

ip ospf authentication

Overview This command sets the authentication method used when sending and receiving OSPF packets on the current interface. The default is to use no authentication. If no authentication method is specified in this command, then plain text authentication will be used.

The **no** variant of this command disables the authentication.

Syntax `ip ospf [<ip-address>] authentication [message-digest|null]`
`no ip ospf [<ip-address>] authentication`

Parameter	Description
<ip-address>	The IP address of the interface.
message-digest	Use the message digest authentication.
null	Use no authentication. This overrides the password or message digest authentication of the interface.

Mode Interface Configuration for a VLAN interface, an Eth interface, an 802.1Q sub-interface, a PPP interface, a bridge, or a tunnel.

Usage notes Use the `ip ospf authentication-key` command to specify a simple text password. Use the `ip ospf message-digest-key` command to specify an MD5 key.

Example To configure PPP interface ppp0 to have no authentication, use the commands:

```
awplus# configure terminal
awplus(config)# interface ppp0
awplus(config-if)# ip ospf authentication null
```

This will override any text or MD5 authentication configured on this interface.

Related commands `ip ospf authentication-key`
`area authentication`
`ip ospf message-digest-key`

ip ospf authentication-key

Overview This command specifies an OSPF authentication password for the neighboring routers.

The **no** variant of this command removes the OSPF authentication password.

Syntax `ip ospf [<ip-address>] authentication-key <pswd-long>`
`no ip ospf [<ip-address>] authentication-key`

Parameter	Description
<ip-address>	The IPv4 address of the interface, in dotted decimal notation.
<pswd-long>	The authentication password. The string you enter at the end of the command line will be used.

Default No password specified

Mode Interface Configuration for a VLAN interface, an Eth interface, an 802.1Q sub-interface, a PPP interface, a bridge, or a tunnel.

Usage notes This command creates a password (key) that is inserted into the OSPF header when AlliedWare Plus™ software originates routing protocol packets. Assign a separate password to each network for different interfaces. All neighboring routers on the same network with the same password exchange OSPF routing data.

The key can be used only when authentication is enabled for an area. Use the **area authentication** command to enable authentication.

Simple password authentication allows a password to be configured for each area. Configure the routers in the same routing domain with the same password.

Example To turn on authentication in area 0 and then create an authentication key named 'very secure password' on PPP interface ppp0, use the commands:

```
awplus# configure terminal
awplus(config)# router ospf 100
awplus(config-router)# network 10.10.10.0/24 area 0
awplus(config-router)# area 0 authentication
awplus(config-router)# exit
awplus(config)# interface ppp0
awplus(config-if)# ip ospf 3.3.3.3 authentication-key very
secure password
```

Related commands [area authentication](#)
[ip ospf authentication](#)

ip ospf cost

Overview This command explicitly specifies the cost of the link-state metric in a router-LSA. The **no** variant of this command resets the interface cost to the default.

Syntax `ip ospf [<ip-address>] cost <1-65535>`
`no ip ospf [<ip-address>] cost`

Parameter	Description
<ip-address>	The IPv4 address of the interface, in dotted decimal notation.
<1-65535>	The link-state metric.

Default No static value. The OSPF cost is automatically calculated by using the [auto-cost reference bandwidth](#) command.

Mode Interface Configuration for a VLAN interface, an Eth interface, an 802.1Q sub-interface, a PPP interface, a bridge, or a tunnel.

Usage notes This command explicitly sets a user specified cost of sending packets out the interface. Using this command overrides the cost value calculated automatically with the auto-cost reference bandwidth feature.

The interface cost indicates the overhead required to send packets across a certain interface. This cost is stated in the Router-LSA's link. Typically, the cost is inversely proportional to the bandwidth of an interface. By default, the cost of an interface is calculated according to the following formula:

- $\text{reference bandwidth} / \text{interface bandwidth}$

Use the **ip ospf cost** command to set the interface cost manually.

Example To set the OSPF cost to 10 on the PPP interface ppp0 for IP address 10.10.10.50, use the commands:

```
awplus# configure terminal
awplus(config)# interface ppp0
awplus(config-if)# ip ospf 10.10.10.50 cost 10
```

Related commands [show ip ospf interface](#)
[auto-cost reference bandwidth](#)

ip ospf database-filter

Overview This command turns on the LSA database-filter for a particular interface. The **no** variant of this command turns off the LSA database-filter.

Syntax `ip ospf [<ip-address>] database-filter all out`
`no ip ospf [<ip-address>] database-filter`

Parameter	Description
<code><ip-address></code>	The IPv4 address of the interface, in dotted decimal notation.

Default All outgoing LSAs are flooded to the interface.

Mode Interface Configuration for a VLAN interface, an Eth interface, an 802.1Q sub-interface, a PPP interface, a bridge, or a tunnel.

Usage notes OSPF floods new LSAs over all interfaces in an area, except the interface on which the LSA arrives. This redundancy ensures robust flooding. However, too much redundancy can waste bandwidth and might lead to excessive link and CPU usage in certain topologies, resulting in destabilizing the network. To avoid this, use the **ip ospf database-filter** command to block flooding of LSAs over specified interfaces.

Example To stop flooding new LSAs on the PPP interface ppp0, use the commands:

```
awplus# configure terminal
awplus(config)# interface ppp0
awplus(config-if# ip ospf database-filter all out
```

ip ospf dead-interval

Overview This command sets the interval during which no hello packets are received and after which a neighbor is declared dead.

The dead-interval is the amount of time that OSPF waits to receive an OSPF hello packet from the neighbor before declaring the neighbor is down. This value is advertised in the router's hello packets. It must be a multiple of the hello-interval and be the same for all routers on a specific network.

The **no** variant of this command returns the interval to the default of 40 seconds. If you have configured this command specifying the IP address of the interface and want to remove the configuration, specify the IP address (**no ip ospf**<ip-address> **dead-interval**).

Syntax ip ospf [<ip-address>] dead-interval <1-65535>
no ip ospf [<ip-address>] dead-interval

Parameter	Description
<ip-address>	The IPv4 address of the interface, in dotted decimal notation.
<1-65535>	The interval in seconds. Default: 40

Mode Interface Configuration for a VLAN interface, an Eth interface, an 802.1Q sub-interface, a PPP interface, a bridge, or a tunnel.

Example To set the dead-interval to 10 seconds on the PPP interface ppp0, use the commands:

```
awplus# configure terminal
awplus(config)# interface ppp0
awplus(config-if)# ip ospf dead-interval 10
```

Related commands [ip ospf hello-interval](#)
[show ip ospf interface](#)

ip ospf disable all

Overview This command completely disables OSPF packet processing on an interface. It overrides the [network area](#) command and disables the processing of packets on the specific interface.

Use the **no** variant of this command to restore OSPF packet processing on a selected interface.

Syntax `ip ospf disable all`
`no ip ospf disable all`

Mode Interface Configuration for a VLAN interface, an Eth interface, an 802.1Q sub-interface, a PPP interface, a bridge, or a tunnel.

Example To disable OSPF packet processing on the PPP interface ppp0, use the commands:

```
awplus# configure terminal
awplus(config)# interface ppp0
awplus(config-if)# ip ospf disable all
```

ip ospf hello-interval

Overview This command specifies the interval between hello packets.

The hello-interval is advertised in the hello packets. Configure the same hello-interval for all routers on a specific network. A shorter hello interval ensures faster detection of topological changes, but results in more routing traffic.

The **no** variant of this command returns the interval to the default of 10 seconds.

Syntax `ip ospf [<ip-address>] hello-interval <1-65535>`
`no ip ospf [<ip-address>] hello-interval`

Parameter	Description
<ip-address>	The IP address of the interface, in dotted decimal notation.
<1-65535>	The interval in seconds. Default: 10

Default 10 seconds

Mode Interface Configuration for a VLAN interface, an Eth interface, an 802.1Q sub-interface, a PPP interface, a bridge, or a tunnel.

Example To set the hello-interval to 3 seconds on the PPP interface ppp0, use the commands:

```
awplus# configure terminal
awplus(config)# interface ppp0
awplus(config-if)# ip ospf hello-interval 3
```

Related commands [ip ospf dead-interval](#)
[show ip ospf interface](#)

ip ospf message-digest-key

Overview This command registers an MD5 key for OSPF MD5 authentication.

Message Digest Authentication is a cryptographic authentication. A key (password) and key-id are configured on each router. The router uses an algorithm based on the OSPF packet, the key, and the key-id to generate a message digest that gets appended to the packet.

The **no** variant of this command removes the MD5 key.

Syntax

```
ip ospf [<ip-address>] message-digest-key <key-id> md5  
<pswd-long>  
  
no ip ospf [<ip-address>] message-digest-key <key-id>
```

Parameter	Description
<ip-address>	The IPv4 address of the interface, in dotted decimal notation.
<key-id>	A key ID number specified as an integer between 1 and 255.
md5	Use the MD5 algorithm.
<pswd-long>	The OSPF password. This is a string of 1 to 16 characters including spaces.

Default No MD5 key registered

Mode Interface Configuration for a VLAN interface, an Eth interface, an 802.1Q sub-interface, a PPP interface, a bridge, or a tunnel.

Usage notes Use this command for uninterrupted transitions between passwords. It allows you to add a new key without having to delete the existing key. While multiple keys exist, all OSPF packets will be transmitted in duplicate; one copy of the packet will be transmitted for each of the current keys. This is helpful for administrators who want to change the OSPF password without disrupting communication. The system begins a rollover process until all the neighbors have adopted the new password. This allows neighboring routers to continue communication while the network administrator is updating them with a new password. The router will stop sending duplicate packets once it detects that all of its neighbors have adopted the new password.

Maintain only one password per interface, removing the old password whenever you add a new one. This will prevent the local system from continuing to communicate with the system that is using the old password. Removing the old password also reduces overhead during rollover. All neighboring routers on the same network must have the same password value to enable exchange of OSPF routing data.

Examples To configure OSPF authentication on the PPP interface ppp0, with a key of 'yourpass', use the commands:

```
awplus# configure terminal
awplus(config)# interface ppp0
awplus(config-if)# ip ospf authentication message-digest
awplus(config-if)# ip ospf message-digest-key 1 md5 yourpass
```

ip ospf mtu

Overview This command sets the MTU size for OSPF. Whenever OSPF constructs packets, it uses the interface MTU size as Maximum IP packet size. This command forces OSPF to use the specified value, instead of the actual interface MTU size.

Use the **no** variant of this command to return the MTU size to the default.

Syntax `ip ospf mtu <mtu-size>`
`no ip ospf mtu`

Parameter	Description
<code><mtu-size></code>	<code><576-65535></code> The MTU size in bytes.

Default OSPF uses the interface MTU derived from the interface

Mode Interface Configuration for a VLAN interface, an Eth interface, an 802.1Q sub-interface, a PPP interface, a bridge, or a tunnel.

Usage notes This command allows an administrator to configure the MTU size recognized by the OSPF protocol. It does not configure the MTU settings on the interface.

This command can be useful to ensure the OSPF neighbor relationship can fully establish via a network link, where the neighboring devices may have mismatched interface MTUs.

Example To change the OSPF MTU to 1446 on the PPP interface ppp0, use the commands:

```
awplus# configure terminal
awplus(config)# interface ppp0
awplus(config-if)# ip ospf mtu 1446
```

ip ospf mtu-ignore

Overview Use this command to configure OSPF so that OSPF does not check the MTU size during DD (Database Description) exchange.

Use the **no** variant of this command to make sure that OSPF checks the MTU size during DD exchange.

Syntax `ip ospf [<ip-address>] mtu-ignore`
`no ip ospf [<ip-address>] mtu-ignore`

Parameter	Description
<code><ip-address></code>	The IPv4 address of the interface, in dotted decimal notation.

Mode Interface Configuration for a VLAN interface, an Eth interface, an 802.1Q sub-interface, a PPP interface, a bridge, or a tunnel.

Usage notes By default, during the DD exchange process, OSPF checks the MTU size described in the DD packets received from the neighbor. If the MTU size does not match the interface MTU, the neighbor adjacency is not established. Using this command makes OSPF ignore this check and allows establishing of adjacency regardless of MTU size in the DD packet.

Example To stop OSPF from checking the MTU size during DD exchange on the PPP interface ppp0, use the commands:

```
awplus# configure terminal
awplus(config)# interface ppp0
awplus(config-if)# ip ospf mtu-ignore
```

ip ospf network

Overview This command configures the OSPF network type to a type different from the default for the particular interface.

The **no** variant of this command returns the network type to the default for the particular interface.

Syntax `ip ospf network {broadcast|non-broadcast|point-to-point|point-to-multipoint}`
`no ip ospf network`

Parameter	Description
<code>broadcast</code>	Sets the network type to broadcast.
<code>non-broadcast</code>	Sets the network type to NBMA.
<code>point-to-multipoint</code>	Sets the network type to point-to-multipoint.
<code>point-to-point</code>	Sets the network type to point-to-point.

Default The default is the default type for the interface, e.g broadcast for VLANs.

Mode Interface Configuration for a VLAN interface, an Eth interface, an 802.1Q sub-interface, a PPP interface, a bridge, or a tunnel.

Usage notes This command forces the interface network type to be the specified type. Depending on the network type, OSPF changes the behavior of the packet transmission and the link description in LSAs.

Example The following example shows setting the network type to point-to-point on the interface eth1:

```
awplus# configure terminal
awplus(config)# interface eth1
awplus(config-if)# ip ospf network point-to-point
```

ip ospf priority

Overview This command sets the router priority, which is a parameter used in the election of the designated router for the network.

The **no** variant of this command returns the router priority to the default of 1.

Syntax `ip ospf [<ip-address>] priority <priority>`
`no ip ospf [<ip-address>] priority`

Parameter	Description
<ip-address>	The IP address of the interface.
<priority>	<0-255> The Router Priority of the interface.

Default 1

Mode Interface Configuration for a VLAN interface, an Eth interface, an 802.1Q sub-interface, a PPP interface, a bridge, or a tunnel.

Usage notes Set the priority to help determine the OSPF Designated Router (DR) for a network. If two routers attempt to become the DR, the router with the higher router priority becomes the DR. If the router priority is the same for two routers, the router with the higher router ID takes precedence.

Only routers with nonzero router priority values are eligible to become the designated or backup designated router.

Configure router priority for multi-access networks only and not for point-to-point networks.

Example To set the OSPF priority value to 3 on the PPP interface ppp0, use the commands:

```
awplus# configure terminal
awplus(config)# interface ppp0
awplus(config-if)# ip ospf priority 3
```

Related commands [ip ospf network](#)

ip ospf resync-timeout

Overview Use this command to set the interval after which adjacency is reset if out-of-band resynchronization has not occurred. The interval period starts from the time a restart signal is received from a neighbor.

Use the **no** variant of this command to return to the default.

Syntax `ip ospf [<ip-address>] resync-timeout <1-65535>`
`no ip ospf [<ip-address>] resync-timeout`

Parameter	Description
<ip-address>	The IP address of the interface.
<1-65535>	The resynchronization timeout value of the interface in seconds.

Mode Interface Configuration for a VLAN interface, an Eth interface, an 802.1Q sub-interface, a PPP interface, a bridge, or a tunnel.

Example To set the OSPF resynchronization timeout value to 65 seconds on the PPP interface ppp0, use the commands:

```
awplus# configure terminal
awplus(config)# interface ppp0
awplus(config-if)# ip ospf resync-timeout 65
```

ip ospf retransmit-interval

Overview Use this command to specify the time between link-state advertisement (LSA) retransmissions for adjacencies belonging to the interface.

Use the **no** variant of this command to return to the default of 5 seconds.

Syntax `ip ospf [<ip-address>] retransmit-interval <1-65535>`
`no ip ospf [<ip-address>] retransmit-interval`

Parameter	Description
<ip-address>	The IP address of the interface.
<1-65535>	The interval in seconds.

Default 5 seconds

Mode Interface Configuration for a VLAN interface, an Eth interface, an 802.1Q sub-interface, a PPP interface, a bridge, or a tunnel.

Usage notes After sending an LSA to a neighbor, the router keeps the LSA until it receives an acknowledgment. In case the router does not receive an acknowledgment during the set time (the retransmit interval value) it retransmits the LSA. Set the retransmission interval value conservatively to avoid needless retransmission. The interval should be greater than the expected round-trip delay between two routers.

Example To set the retransmit interval to 6 seconds on the PPP interface ppp0, use the commands:

```
awplus# configure terminal
awplus(config)# interface ppp0
awplus(config-if)# ip ospf retransmit-interval 6
```

ip ospf transmit-delay

Overview Use this command to set the estimated time it takes to transmit a link-state-update packet on the interface.

Use the **no** variant of this command to return to the default of 1 second.

Syntax `ip ospf [<ip-address>] transmit-delay <1-65535>`
`no ip ospf [<ip-address>] transmit-delay`

Parameter	Description
<ip-address>	The IP address of the interface.
<1-65535>	The time, in seconds, to transmit a link-state update.

Default 1 second

Mode Interface Configuration for a VLAN interface, an Eth interface, an 802.1Q sub-interface, a PPP interface, a bridge, or a tunnel.

Usage notes The transmit delay value adds a specified time to the age field of an update. If the delay is not added, the time in which the LSA transmits over the link is not considered. This command is especially useful for low speed links. Add transmission and propagation delays when setting the transmit delay value.

Example To set the OSPF transmit delay time to 3 seconds on the PPP interface ppp0, use the commands:

```
awplus# configure terminal
awplus(config)# interface ppp0
awplus(config-if)# ip ospf transmit-delay 3
```

max-concurrent-dd

Overview Use this command to set the limit for the number of Database Descriptors (DD) that can be processed concurrently.

Use the **no** variant of this command to reset the limit for the number of Database Descriptors (DD) that can be processed concurrently.

Syntax `max-concurrent-dd <1-65535>`
`no max-concurrent-dd`

Parameter	Description
<1-65535>	Specify the number of DD processes.

Mode Router Configuration

Usage This command is useful when a router's performance is affected from simultaneously bringing up several OSPF adjacencies. This command limits the maximum number of DD exchanges that can occur concurrently per OSPF instance, thus allowing for all of the adjacencies to come up.

Example The following example sets the max-concurrent-dd value to 4, so that only 4 DD exchanges will be processed at a time.

```
awplus# configure terminal
awplus(config)# router ospf 100
awplus(config-router)# max-concurrent-dd 4
```

maximum-area

Overview Use this command to set the maximum number of OSPF areas.

Use the **no** variant of this command to set the maximum number of OSPF areas to the default.

Syntax `maximum-area <1-4294967294>`
`no maximum-area`

Parameter	Description
<code><1-4294967294></code>	Specify the maximum number of OSPF areas.

Default The default for the maximum number of OSPF areas is 4294967294.

Mode Router Configuration

Usage notes Use this command in router OSPF mode to specify the maximum number of OSPF areas.

Examples The following example sets the maximum number of OSPF areas to 2:

```
awplus# configure terminal
awplus(config)# router ospf 100
awplus(config-router)# maximum-area 2
```

The following example removes the maximum number of OSPF areas and resets to default:

```
awplus# configure terminal
awplus(config)# router ospf 100
awplus(config-router)# no maximum-area
```

neighbor (OSPF)

Overview Use this command to inform the router of other neighboring routers that are connected to the same NBMA network.

Use the **no** variant of this command to remove a configuration.

Syntax `neighbor <ip-address> [<cost>]{<priority>|<poll-interval>}`
`no neighbor <ip-address> [<cost>]{<priority>|<poll-interval>}`

Parameter	Description
<code><ip-address></code>	Specifies the interface IP address of the neighbor.
<code><priority></code>	<i>priority <0-255></i> Specifies the router priority value of the non-broadcast neighbor associated with the specified IP address. The default is 0. This keyword does not apply to point-to-multipoint interfaces.
<code><poll-interval></code>	<i>poll-interval <1-2147483647></i> Dead neighbor polling interval in seconds. It is recommended to set this value much higher than the hello interval. The default is 120 seconds.
<code><cost></code>	<i>cost <1-65535></i> Specifies the link-state metric to this neighbor.

Mode Router Configuration

Usage To configure a neighbor on an NBMA network manually, use the `neighbor` command and include one neighbor entry for each known nonbroadcast network neighbor. The IP address used in this command is the neighbor's primary IP address on the interface where that neighbor connects to the NBMA network.

The poll interval is the reduced rate at which routers continue to send hello packets, when a neighboring router has become inactive. Set the poll interval to be much larger than hello interval.

Examples This example shows a neighbor configured with a priority value, poll interval time, and cost.

```
awplus# configure terminal
awplus(config)# router ospf 100
awplus(config-router)# neighbor 1.2.3.4 priority 1
poll-interval 90
awplus(config-router)# neighbor 1.2.3.4 cost 15
```

network area

Overview Use this command to enable OSPF routing with a specified Area ID on any interfaces with IP addresses that match the specified network address.

Use the **no** variant of this command to disable OSPF routing on the interfaces.

Syntax `network <network-address> area <area-id>`
`no network <network-address> area <area-id>`

Parameter	Description
<network-address>	{<ip-network/m> <ip-addr> <reverse-mask>}
<ip-network/m>	IP address of the network, entered in the form A.B.C.D/M. Dotted decimal notation followed by a forward slash, and then the subnet mask length.
<ip-addr> <reverse-mask>	IPv4 network address, entered in the form A.B.C.D, followed by the mask. Enter the mask as a wildcard, or reverse, mask (e.g. 0.0.0.255). Note that the device displays the mask as a subnet mask in the running configuration.
<area-id>	{<ip-addr> <0-4294967295>}
<ip-addr>	OSPF Area ID in IPv4 address format, in the form A.B.C.D.
<0-4294967295>	OSPF Area ID as 4 octets unsigned integer value.

Default No **network area** is configured by default.

Mode Router Configuration

Usage notes OSPF routing can be enabled per IPv4 subnet. The network address can be defined using either the prefix length or a wild card mask. A wild card mask is comprised of consecutive 0's as network bits and consecutive 1's as host bits.

Examples The following commands show the use of the **network area** command with OSPF multiple instance support disabled:

```
awplus# configure terminal
awplus(config)# router ospf 100
awplus(config-router)# network 10.0.0.0/8 area 3
awplus(config-router)# network 10.0.0.0/8 area 1.1.1.1
```

The following commands disable OSPF routing with Area ID 3 on all interfaces:

```
awplus# configure terminal
awplus(config)# router ospf 100
awplus(config-router)# no network 10.0.0.0/8 area3
```

ospf abr-type

Overview Use this command to set an OSPF Area Border Router (ABR) type.

Use the **no** variant of this command to revert the ABR type to the default setting (Cisco).

Syntax `ospf abr-type {cisco|ibm|standard}`
`no ospf abr-type {cisco|ibm|standard}`

Parameter	Description
cisco	Specifies an alternative ABR using Cisco implementation (RFC 3509). This is the default ABR type.
ibm	Specifies an alternative ABR using IBM implementation (RFC 3509).
standard	Specifies a standard behavior ABR (RFC 2328).

Default ABR type `Cisco`

Mode Router Configuration

Usage Specifying the ABR type allows better interoperability between different implementations. This command is especially useful in a multi-vendor environment. The different ABR types are:

- Cisco ABR Type: By this definition, a router is considered an ABR if it has more than one area actively attached and one of them is the backbone area.
- IBM ABR Type: By this definition, a router is considered an ABR if it has more than one area actively attached and the backbone area is configured. In this case the configured backbone need not be actively connected.
- Standard ABR Type: By this definition, a router is considered an ABR if it has more than one area actively attached to it.

Example `awplus# configure terminal`
`awplus(config)# router ospf 100`
`awplus(config-router)# ospf abr-type ibm`

ospf restart grace-period

Overview Use this command to configure the grace-period for restarting OSPF routing. Use the **no** variant of this command to revert to the default grace-period.

Syntax ospf restart grace-period <1-1800>
no ospf restart grace-period

Parameter	Description
<1-1800>	Specifies the grace period in seconds.

Default In the AlliedWare Plus™ OSPF implementation, the default OSPF grace-period is 180 seconds.

Mode Global Configuration

Usage notes Use this command to enable the OSPF Graceful Restart feature and set the restart grace-period. Changes from the default restart grace-period are displayed in the running- config. The restart grace-period is not displayed in the running-config if it has been reset to the default using the **no** variant of this command.

Example To set the OSPF restart grace-period to 250 seconds, use the commands:

```
awplus# configure terminal  
awplus(config)# ospf restart grace-period 250
```

To reset the OSPF restart grace-period to the default (180 seconds), use the commands:

```
awplus# configure terminal  
awplus(config)# no ospf restart grace-period
```

Validation Commands [show running-config](#)

Related commands [ospf restart helper](#)
[restart ospf graceful](#)

ospf restart helper

Overview Use this command to configure the **helper** behavior for the OSPF Graceful Restart feature.

Use the **no** variant of this command to revert to the default grace-period.

Syntax

```
ospf restart helper {max-grace-period  
<grace-period>|only-reload|only-upgrade}  
ospf restart helper {never router-id <router-id>}  
no ospf restart helper [max-grace-period]
```

Parameter	Description
max-grace-period	Specify help if received grace-period is less than a specified value.
<grace-period>	Maximum grace period accepted in seconds in range <1-1800>.
never	Specify the local policy to never to act as a helper for this feature.
only-reload	Specify help only on software reloads not software upgrades.
only-upgrade	Specify help only on software upgrades not software reloads.
router-id	Enter the router-id keyword to specify the OSPF Router ID that is never to act as a helper for the OSPF Graceful Restart feature.
<router-id>	<A.B.C.D> Specify the OSPF Router ID in dotted decimal format A.B.C.D

Default In the AlliedWare Plus™ OSPF implementation, the default OSPF grace-period is 180 seconds.

Mode Global Configuration

Usage The **ospf restart helper** command requires at least one parameter, but you may use more than one in the same command (excluding parameter **never**).

The **no** version of this command turns off the OSPF restart helper, while the **no ospf restart helper max-grace-period** command resets the max-grace-period, rather than the helper policy itself.

Example

```
awplus# configure terminal  
awplus(config)# ospf restart helper only-reload  
awplus# configure terminal  
awplus(config)# ospf restart helper never router-id 10.10.10.1  
awplus# configure terminal  
awplus(config)# no ospf restart helper max-grace-period
```

**Related
commands** ospf restart grace-period
restart ospf graceful

ospf router-id

Overview Use this command to specify a router ID for the OSPF process.
Use the **no** variant of this command to disable this function.

Syntax ospf router-id *<ip-address>*
no ospf router-id

Parameter	Description
<i><ip-address></i>	Specifies the router ID in IPv4 address format.

Mode Router Configuration

Usage Configure each router with a unique router-id. In an OSPF router process that has active neighbors, a new router-id takes effect at the next reload or when you restart OSPF manually.

Example The following example shows a specified router ID 2.3.4.5.

```
awplus# configure terminal
awplus(config)# router ospf 100
awplus(config-router)# ospf router-id 2.3.4.5
```

Related commands [show ip ospf](#)

overflow database

Overview Use this command to limit the maximum number of Link State Advertisements (LSAs) that can be supported by the current OSPF instance.

Use the **no** variant of this command to have no limit on the maximum number of LSAs.

Syntax `overflow database <0-4294967294> {hard|soft}`
`no overflow database`

Parameter	Description
<0-4294967294>	The maximum number of LSAs.
hard	Shutdown occurs if the number of LSAs exceeds the specified value.
soft	Warning message appears if the number of LSAs exceeds the specified value.

Mode Router Configuration

Usage Use **hard** with this command if a shutdown is required if the number of LSAs exceeds the specified number. Use **soft** with this command if a shutdown is not required, but a warning message is required, if the number of LSAs exceeds the specified number.

Example The following example shows setting the database overflow to 500, and a shutdown to occur, if the number of LSAs exceeds 500.

```
awplus# configure terminal
awplus(config)# router ospf 100
awplus(config-router)# overflow database 500 hard
```

overflow database external

Overview Use this command to configure the size of the external database and the time the router waits before it tries to exit the overflow state.

Use the **no** variant of this command to revert to default.

Syntax `overflow database external <max-lsas> <recover-time>`
`no overflow database external`

Parameter	Description
<code><max-lsas></code>	<code><0-2147483647></code> The maximum number of Link State Advertisements (LSAs). Note that this value should be the same on all routers in the AS.
<code><recover-time></code>	<code><0-65535></code> the number of seconds the router waits before trying to exit the database overflow state. If this parameter is 0, router exits the overflow state only after an explicit administrator command.

Mode Router Configuration

Usage Use this command to limit the number of AS-external-LSAs a router can receive, once it is in the wait state. It takes the number of seconds specified as the `<recover-time>` to recover from this state.

Example The following example shows setting the maximum number of LSAs to 5 and the time to recover from overflow state to be 3:

```
awplus# configure terminal
awplus(config)# router ospf 100
awplus(config-router)# overflow database external 50 3
```

passive-interface (OSPF)

Overview Use this command to suppress the sending of Hello packets on all interfaces, or on a specified interface. If you use the **passive-interface** command without the optional parameters then all interfaces are put into passive mode.

Use the **no** variant of this command to allow the sending of Hello packets on all interfaces, or on the specified interface. If you use the **no** variant of this command without the optional parameters then all interfaces are removed from passive mode.

Syntax `passive-interface [<interface>] [<ip-address>]`
`no passive-interface [<interface>] [<ip-address>]`

Parameter	Description
<interface>	The name of the interface.
<ip-address>	IP address of the interface, entered in the form A.B.C.D.

Mode Router Configuration

Usage notes Configure an interface to be passive if you wish its connected route to be treated as an OSPF route (rather than an AS-external route), but do not wish to actually exchange any OSPF packets via this interface.

Examples To configure passive interface mode on all interfaces, enter the following commands:

```
awplus(config)# router ospf 100  
awplus(config-router)# passive-interface
```

To configure passive interface mode on the local loopback interface, enter the following commands:

```
awplus(config)# router ospf 100  
awplus(config-router)# passive-interface lo
```

To remove passive interface mode on all interfaces, enter the following commands:

```
awplus(config)# router ospf 100  
awplus(config-router)# no passive-interface
```

redistribute (OSPF)

Overview Use this command to redistribute routes from other routing protocols, static routes and connected routes into an OSPF routing table.

Use the **no** variant of this command to disable this function.

Syntax

```
redistribute {bgp|connected|rip|static} {metric  
<0-16777214>|metric-type {1|2}|route-map <name>|tag  
<0-4294967295>}  
  
no redistribute {bgp|connected|rip|static} {metric  
<0-16777214>|metric-type {1|2}|route-map <name>|tag  
<0-4294967295>}
```

Parameter	Description
bgp	Specifies that this applies to the redistribution of BGP routes.
connected	Specifies that this applies to the redistribution of connected routes.
rip	Specifies that this applies to the redistribution of RIP routes.
static	Specifies that this applies to the redistribution of static routes.
metric	Specifies the external metric.
metric-type	Specifies the external metric-type.
route-map	Specifies name of the route-map.
tag	Specifies the external route tag.

Default The default metric value for routes redistributed into OSPF is 20. The metric can also be defined using the [set metric](#) command for a route map. Note that a metric defined using the [set metric](#) command for a route map overrides a metric defined with this command.

Mode Router Configuration

Usage notes You use this command to inject routes, learned from other routing protocols, into the OSPF domain to generate AS-external-LSAs. If a route-map is configured by this command, then that route-map is used to control which routes are redistributed and can set metric and tag values on particular routes.

The metric, metric-type, and tag values specified on this command are applied to any redistributed routes that are not explicitly given a different metric, metric-type, or tag value by the route map.

See the [OSPF Feature Overview and Configuration Guide](#) for more information about metrics, and about behavior when configured in route maps.

Note that this command does not redistribute the default route. To redistribute the default route, use the [default-information originate](#) command.

Example The following example shows redistribution of BGP routes into OSPF routing table 100, with metric 12.

```
awplus# configure terminal
awplus(config)# router ospf 100
awplus(config-router)# redistribute bgp metric 12
```

The following example shows the configuration of a route-map named 'rmap2', which is then applied using the **redistribute route-map** command, so routes learned via a specified interface can be redistributed as type-1 external LSAs:

```
awplus# configure terminal
awplus(config)# route-map rmap2 permit 3
awplus(config-route-map)# match interface eth1
awplus(config-route-map)# set metric-type 1
awplus(config-route-map)# exit
awplus(config)# router ospf 100
awplus(config-router)# redistribute rip route-map rmap2
```

Note that configuring a route-map and applying it with the **redistribute route-map** command allows you to filter which routes are distributed from another routing protocol (such as RIP). A route-map can also set the metric, tag, and metric-type of the redistributed routes.

Related commands

- [match interface](#)
- [route-map](#)
- [show ip ospf database external](#)

restart ospf graceful

Overview Use this command to force the OSPF process to restart, and optionally set the grace-period.

Syntax `restart ospf graceful [grace-period <1-1800>]`

Parameter	Description
<code>grace-period</code>	Specify the grace period.
<code><1-1800></code>	The grace period in seconds.

Default In the AlliedWare Plus™ OSPF implementation, the default OSPF grace-period is 180 seconds.

Mode Privileged Exec

Usage notes After this command is executed, the OSPF process immediately shuts down. It notifies the system that OSPF has performed a graceful shutdown. Routes installed by OSPF are preserved until the grace-period expires.

When a **restart ospf graceful** command is issued, the OSPF configuration is reloaded from the last saved configuration. Ensure you first enter the command [copy running-config startup-config](#).

Example

```
awplus# copy running-config startup-config
awplus# restart ospf graceful grace-period 200
```

Related commands [ospf restart grace-period](#)
[ospf restart helper](#)

router ospf

Overview Use this command to enter Router Configuration mode to configure an OSPF routing process. You must specify the process ID with this command for multiple OSPF routing processes on the device.

Use the **no** variant of this command to terminate an OSPF routing process.

Use the **no** parameter with the **process-id** parameter, to terminate and delete a specific OSPF routing process. If no **process-id** is specified on the **no** variant of this command, then all OSPF routing processes are terminated, and all OSPF configuration is removed.

Syntax `router ospf [<process-id>]`
`no router ospf [<process-id>]`

Syntax (VRF-lite) `router ospf [<process-id>] [<vrf-instance>]`
`no router ospf [<process-id>]`

Parameter	Description
<code><process-id></code>	A positive number from 1 to 65535, that is used to define a routing process.
<code><vrf-instance></code>	The VRF instance to be associated with the OSPF routing process.

Default No routing process is defined by default.

Mode Global Configuration

Usage notes The process ID of OSPF is an optional parameter for the **no** variant of this command only. When removing all instances of OSPF, you do not need to specify each Process ID, but when removing particular instances of OSPF you must specify each Process ID to be removed.

When using VRF-lite, this command can be used to associate a process-id with a VRF instance that has been created using the [ip vrf](#) command.

Example To enter Router Configuration mode to configure an existing OSPF routing process 100, use the commands:

```
awplus# configure terminal
awplus(config)# router ospf 100
awplus(config-router)#
```

Example (VRF-lite) To enter Router Configuration mode to configure an existing OSPF routing process 100 for VRF instance `red`, use the commands:

```
awplus# configure terminal
awplus(config)# router ospf 100 red
awplus(config-router)#
```

Command changes Version 5.4.6-2.1: VRF-lite support added.

router-id

Overview Use this command to specify a router ID for the OSPF process.
Use the **no** variant of this command to force OSPF to use the previous OSPF router-id behavior.

Syntax `router-id <ip-address>`
`no router-id`

Parameter	Description
<code><ip-address></code>	Specifies the router ID in IPv4 address format.

Mode Router Configuration

Usage Configure each router with a unique router-id. In an OSPF router process that has active neighbors, a new router-id is used at the next reload or when you restart OSPF manually.

Example The following example shows a fixed router ID 10.10.10.60

```
awplus# configure terminal
awplus(config)# router ospf 100
awplus(config-router)# router-id 10.10.10.60
```

Related commands [show ip ospf](#)

show debugging ospf

Overview Use this command to see what debugging is turned on for OSPF.

For information on filtering and saving command output, see the [“Getting_Started with AlliedWare Plus” Feature Overview and Configuration_Guide](#).

Syntax `show debugging ospf`

Mode User Exec and Privileged Exec

Example `awplus# show debugging ospf`

Output Figure 27-2: Example output from the **show debugging ospf** command

```
OSPF debugging status:
  OSPF packet Link State Update debugging is on
  OSPF all events debugging is on
```

show ip ospf

Overview Use this command to display general information about all OSPF routing processes. Include the process ID parameter with this command to display information about specified instances.

For information on filtering and saving command output, see the [“Getting Started with AlliedWare Plus” Feature Overview and Configuration Guide](#).

Syntax `show ip ospf`
`show ip ospf <process-id>`

Parameter	Description
<process-id>	<0-65535> The ID of the router process for which information will be displayed. If this parameter is included, only the information for the specified routing process is displayed.

Mode User Exec and Privileged Exec

Examples To display general information about all OSPF routing processes, use the command:

```
awplus# show ip ospf
```

To display general information about OSPF routing process 100, use the command:

```
awplus# show ip ospf 100
```

Table 1: Example output from the **show ip ospf** command

```
Route Licence: Route : Limit=0, Allocated=0, Visible=0, Internal=0
Route Licence: Breach: Current=0, Watermark=0
Routing Process "ospf 10" with ID 192.168.1.1
Process uptime is 10 hours 24 minutes
Process bound to VRF default
Conforms to RFC2328, and RFC1583 Compatibility flag is disabled
Supports only single TOS(TOS0) routes
Supports opaque LSA
Supports Graceful Restart
SPF schedule delay min 0.500 secs, SPF schedule delay max 50.0 secs
Refresh timer 10 secs
Number of incoming current DD exchange neighbors 0/5
Number of outgoing current DD exchange neighbors 0/5
Number of external LSA 0. Checksum 0x000000
Number of opaque AS LSA 0. Checksum 0x000000
Number of non-default external LSA 0
```

Table 1: Example output from the **show ip ospf** command (cont.)

```
External LSA database is unlimited.
Number of LSA originated 0
Number of LSA received 0
Number of areas attached to this router: 2
  Area 0 (BACKBONE) (Inactive)
    Number of interfaces in this area is 0(0)
    Number of fully adjacent neighbors in this area is 0
    Area has no authentication
    SPF algorithm executed 0 times
    Number of LSA 0. Checksum 0x000000

  Area 1 (Inactive)
    Number of interfaces in this area is 0(0)
    Number of fully adjacent neighbors in this area is 0
    Number of fully adjacent virtual neighbors through this area is 0
    Area has no authentication
    SPF algorithm executed 0 times
    Number of LSA 0. Checksum 0x000000
```

Table 2: Example output from the **show ip ospf <process-id>** command

```
Routing Process "ospf 100" with ID 10.10.11.146
Process uptime is 0 minute
Conforms to RFC2328, and RFC1583Compatibility flag is disabled
Supports only single TOS(TOS0) routes
Supports opaque LSA
SPF schedule delay 5 secs, Hold time between two SPFs 10 secs
Refresh timer 10 secs
Number of external LSA 0. Checksum Sum 0x0
Number of non-default external LSA 0
External LSA database is unlimited.
Number of areas attached to this router: 1
  Area 1
    Number of interfaces in this area is 1(1)
    Number of fully adjacent neighbors in this area is 0
    Number of fully adjacent virtual neighbors through this area is 0
    Area has no authentication
    SPF algorithm executed 0 times
    Number of LSA 1. Checksum Sum 0x00e3e2
```

Table 3: Parameters in the output of the **show ip ospf** command

Output Parameter		Meaning
Route Licence: Route:	Limit	The maximum number of OSPF routes which may be used for forwarding.
	Allocated	The current total number of OSPF routes allocated in the OSPF module.
	Visible	The current number of OSPF routes which may be used for forwarding.
	Internal	The number of OSPF internal routes used for calculating paths to ASBRs.
Number of external LSA		The number of external link-state advertisements
Number of opaque AS LSA		Number of opaque link-state advertisements

Related commands [router ospf](#)

show ip ospf border-routers

Overview Use this command to display the ABRs and ASBRs for all OSPF instances. Include the process ID parameter with this command to view data about specified instances.

For information on filtering and saving command output, see the [“Getting Started with AlliedWare Plus” Feature Overview and Configuration Guide](#).

Syntax `show ip ospf border-routers`
`show ip ospf <process-id> border-routers`

Parameter	Description
<code><process-id></code>	<code><0-65535></code> The ID of the router process for which information will be displayed.

Mode User Exec and Privileged Exec

Examples To display the ABRs and ASBRs for all OSPF instances, use the following command:

```
awplus# show ip ospf border-routers
```

Output Figure 27-3: Example output from the **show ip ospf border-routers** command

```
OSPF process 1 internal Routing Table
Codes: i - Intra-area route, I - Inter-area route
i 10.15.0.1 [10] via 10.10.0.1, eth1, ASBR, Area 0.0.0.0
...
```

show ip ospf database

Overview Use this command to display a database summary for OSPF information. Include the process ID parameter with this command to display information about specified instances.

For information on filtering and saving command output, see the [“Getting Started with AlliedWare Plus” Feature Overview and Configuration Guide](#).

Syntax `show ip ospf [<process-id>] database
[self-originate|max-age|adv router <adv-router-id>]`

Parameter	Description
<process-id>	<0-65535> The ID of the router process for which information will be displayed.
self-originate	Displays self-originated link states.
max-age	Displays LSAs in MaxAge list. It maintains the list of the all LSAs in the database which have reached the max-age which is 3600 seconds.
adv-router	Advertising Router LSA.
<adv-router-id>	The Advertising Router ID (usually entered in IPv4 address format A.B.C.D). Note that this ID component no longer represents an address; it is simply a character string that has an IPv4 address format.

Mode User Exec and Privileged Exec

Examples To display the ABRs and ASBRs for all OSPF instances, use the command:

```
awplus# show ip ospf border-routers
```

To display the ABRs and ASBRs for the specific OSPF instance 721, use the command:

```
awplus# show ip ospf 721 border-routers
```

Output Figure 27-4: Example output from the **show ip ospf database** command

```

      OSPF Router process 1 with ID (10.10.11.60)
      Router Link States (Area 0.0.0.1)
Link ID          ADV Router      Age  Seq#           CkSum  Link
count
10.10.11.60     10.10.11.60      32  0x80000002    0x472b  1
      OSPF Router process 100 with ID (10.10.11.60)
      Router Link States (Area 0.0.0.0)
Link ID          ADV Router      Age  Seq#           CkSum  Link
count
10.10.11.60     10.10.11.60      219 0x80000001    0x4f5d  0

```

Example awplus# show ip ospf database external 1.2.3.4 self-originate
awplus# show ip ospf database self-originate

Figure 27-5: Example output from the **show ip ospf database self-originate** command

```
OSPF Router process 100 with ID (10.10.11.50)
Router Link States (Area 0.0.0.1 [NSSA])
Link ID      ADV Router      Age  Seq#           CkSum  Link
count
10.10.11.50  10.10.11.50     20  0x80000007    0x65c3 2
Area-Local Opaque-LSA (Area 0.0.0.1 [NSSA])
Link ID      ADV Router      Age  Seq#           CkSum  Opaque ID
67.1.4.217  10.10.11.50     37  0x80000001    0x2129 66777
AS-Global Opaque-LSA
Link ID      ADV Router      Age  Seq#           CkSum  Opaque ID
67.1.4.217  10.10.11.50     37  0x80000001    0x2daa 66777
```

show ip ospf database asbr-summary

Overview Use this command to display information about the Autonomous System Boundary Router (ASBR) summary LSAs.

For information on filtering and saving command output, see the [“Getting Started with AlliedWare Plus”_Feature Overview and Configuration Guide](#).

Syntax `show ip ospf database asbr-summary [<ip-addr>]
[self-originate|adv-router <advrouter-ip-addr>]`

Parameter	Description
<ip-addr>	A link state ID, as an IP address.
self-originate	Displays self-originated link states.
adv-router <advrouter-ip-addr>	Displays all the LSAs of the specified router.

Mode User Exec and Privileged Exec

Examples

```
awplus# show ip ospf database asbr-summary 1.2.3.4  
self-originate  
  
awplus# show ip ospf database asbr-summary self-originate  
  
awplus# show ip ospf database asbr-summary 1.2.3.4 adv-router  
2.3.4.5
```

show ip ospf database external

Overview Use this command to display information about the external LSAs.

For information on filtering and saving command output, see the [“Getting Started with AlliedWare Plus” Feature Overview and Configuration Guide](#).

Syntax `show ip ospf database external adv-router[<adv-router-id>]
[self-originate|adv-router<adv-router-id>]`

Parameter	Description
adv-router	Displays all the LSAs of the specified router.
self-originate	Displays self-originated link states.
<adv-router- id>	The Advertising Router ID (usually entered in IPv4 address format A.B.C.D). Note that this ID component no longer represents an address; it is simply a character string that has an IPv4 address format.

Mode User Exec and Privileged Exec

Examples

```
awplus# show ip ospf database external 1.2.3.4 self-originate
awplus# show ip ospf database external self-originate
awplus# show ip ospf database external 1.2.3.4 adv-router
2.3.4.5
```

Output Figure 27-6: Example output from the **show ip ospf database external self-originate** command

```
OSPF Router process 100 with ID (10.10.11.50)
AS External Link States
LS age: 298
Options: 0x2 (*|-|-|-|-|E|-)
LS Type: AS-external-LSA
Link State ID: 10.10.100.0 (External Network Number)
Advertising Router: 10.10.11.50
LS Seq Number: 80000001
Checksum: 0x7033
Length: 36
Network Mask: /24
Metric Type: 2 (Larger than any link state path)
TOS: 0
Metric: 20
Forward Address: 10.10.11.50
External Route Tag: 0
```

Output Figure 27-7: Example output from the **show ip ospf database external adv-router** command

```
awplus#show ip ospf database external adv-router 1.1.1.1

                AS External Link States
LS age: 273
Options: 0x2 (-|-|-|-|-|E|-)
LS Type: AS-external-LSA
Link State ID: 172.16.0.0 (External Network Number)
Advertising Router: 1.1.1.1
LS Seq Number: 80000004
Checksum: 0x02f8
Length: 36
Network Mask: /24
    Metric Type: 2 (Larger than any link state path)
    TOS: 0
    Metric: 20
    Forward Address: 0.0.0.0
    External Route Tag: 0
```

show ip ospf database network

Overview Use this command to display information about the network LSAs.

For information on filtering and saving command output, see the [“Getting Started with AlliedWare Plus” Feature Overview and Configuration Guide](#).

Syntax `show ip ospf database network [<adv-router-id>]
[self-originate|<adv-router-id>]`

Parameter	Description
<adv-router-id>	The router ID of the advertising router, in IPv4 address format. Note however, that this no longer represents a real address.
self-originate	Displays self-originated link states.
adv-router	Displays all the LSAs of the specified router.

Mode User Exec and Privileged Exec

Examples `awplus# show ip ospf database network 1.2.3.4 self-originate`
`awplus# show ip ospf database network self-originate`
`awplus# show ip ospf database network 1.2.3.4 adv-router 2.3.4.5`

Output Figure 27-8: Example output from the **show ip ospf database network** command

```
OSPF Router process 200 with ID (192.30.30.2)
  Net Link States (Area 0.0.0.0)
LS age: 1387
Options: 0x2 (*|-|-|-|-|E|-)
LS Type: network-LSA
Link State ID: 192.10.10.9 (address of Designated Router)
Advertising Router: 192.30.30.3
LS Seq Number: 80000001
Checksum: 0xe1b0
Length: 32
Network Mask: /24
  Attached Router: 192.20.20.1
  Attached Router: 192.30.30.3
OSPF Router process 200 with ID (192.30.30.2)
  Net Link States (Area 0.0.0.0)
...
```

show ip ospf database nssa-external

Overview Use this command to display information about the NSSA external LSAs.

For information on filtering and saving command output, see the [“Getting Started with AlliedWare Plus” Feature Overview and Configuration Guide](#).

Syntax `show ip ospf database nssa-external [<ip-address>]
[self-originate|<advrouter>]`

Parameter	Description
<advrouter>	adv-router <ip-address>
adv-router	Displays all the LSAs of the specified router.
<ip-address>	A link state ID, as an IP address.
self-originate	Displays self-originated link states.

Mode User Exec and Privileged Exec

Examples

```
awplus# show ip ospf database nssa-external 1.2.3.4  
self-originate  
  
awplus# show ip ospf database nssa-external self-originate  
  
awplus# show ip ospf database nssa-external 1.2.3.4 adv-router  
2.3.4.5
```

Output Figure 27-9: Example output from the **show ip ospf database nssa-external adv-router** command

```
OSPF Router process 100 with ID (10.10.11.50)  
    NSSA-external Link States (Area 0.0.0.0)  
    NSSA-external Link States (Area 0.0.0.1 [NSSA])  
  
LS age: 78  
Options: 0x0 (*|-|-|-|-|-|-|-)  
LS Type: AS-NSSA-LSA  
Link State ID: 0.0.0.0 (External Network Number For NSSA)  
Advertising Router: 10.10.11.50  
LS Seq Number: 80000001  
Checksum: 0xc9b6  
Length: 36  
Network Mask: /0  
    Metric Type: 2 (Larger than any link state path)  
    TOS: 0  
    Metric: 1  
    NSSA: Forward Address: 0.0.0.0
```

```
OSPF Router process 100 with ID (10.10.11.50)
  NSSA-external Link States (Area 0.0.0.0)
  NSSA-external Link States (Area 0.0.0.1 [NSSA])
LS age: 78
Options: 0x0 (*|---|---|---|)
LS Type: AS-NSSA-LSA
Link State ID: 0.0.0.0 (External Network Number For NSSA)
Advertising Router: 10.10.11.50
LS Seq Number: 80000001
Checksum: 0xc9b6
Length: 36
Network Mask: /0
  Metric Type: 2 (Larger than any link state path)
  TOS: 0
  Metric: 1
  NSSA: Forward Address: 0.0.0.0
  External Route Tag: 0
  NSSA-external Link States (Area 0.0.0.1 [NSSA])
```

show ip ospf database opaque-area

Overview Use this command to display information about the area-local (link state type 10) scope LSAs. Type-10 Opaque LSAs are not flooded beyond the borders of their associated area.

For information on filtering and saving command output, see the [“Getting Started with AlliedWare Plus” Feature Overview and Configuration Guide](#).

Syntax `show ip ospf database opaque-area [<ip-address>]
[self-originate|<advrouter>]`

Parameter	Description
<advrouter>	adv-router <ip-address>
adv-router	Displays all the LSAs of the specified router.
<ip-address>	A link state ID, as an IP address.
self-originate	Displays self-originated link states.

Mode User Exec and Privileged Exec

Examples

```
awplus# show ip ospf database opaque-area 1.2.3.4  
self-originate  
  
awplus# show ip ospf database opaque-area self-originate  
  
awplus# show ip ospf database opaque-area 1.2.3.4 adv-router  
2.3.4.5
```

Output Figure 27-10: Example output from the **show ip ospf database opaque-area** command

```
OSPF Router process 100 with ID (10.10.11.50)  
Area-Local Opaque-LSA (Area 0.0.0.0)  
LS age: 262  
Options: 0x2 (*|-|-|-|-|E|-)  
LS Type: Area-Local Opaque-LSA  
Link State ID: 10.0.25.176 (Area-Local Opaque-Type/ID)  
Opaque Type: 10  
Opaque ID: 6576  
Advertising Router: 10.10.11.50  
LS Seq Number: 80000001  
Checksum: 0xb413  
Length: 26
```

show ip ospf database opaque-as

Overview Use this command to display information about the link-state type 11 LSAs. This type of link-state denotes that the LSA is flooded throughout the Autonomous System (AS).

For information on filtering and saving command output, see the [“Getting Started with AlliedWare Plus” Feature Overview and Configuration Guide](#).

Syntax `show ip ospf database opaque-as [<ip-address>]
[self-originate|<advrouter>]`

Parameter	Description
<advrouter>	adv-router <ip-address>
adv-router	Displays all the LSAs of the specified router.
<ip-address>	A link state ID, as an IP address.
self-originate	Displays self-originated link states.

Mode User Exec and Privileged Exec

Examples

```
awplus# show ip ospf database opaque-as 1.2.3.4 self-originate
awplus# show ip ospf database opaque-as self-originate
awplus# show ip ospf database opaque-as 1.2.3.4 adv-router
2.3.4.5
```

Output Figure 27-11: Example output from the **show ip ospf database opaque-as** command

```
OSPF Router process 100 with ID (10.10.11.50)
AS-Global Opaque-LSA
LS age: 325
Options: 0x2 (*|---|---|E|)
LS Type: AS-external Opaque-LSA
Link State ID: 11.10.9.23 (AS-external Opaque-Type/ID)
Opaque Type: 11
Opaque ID: 657687
Advertising Router: 10.10.11.50
LS Seq Number: 80000001
Checksum: 0xb018
Length: 25
```

show ip ospf database opaque-link

Overview Use this command to display information about the link-state type 9 LSAs. This type denotes a link-local scope. The LSAs are not flooded beyond the local network.

For information on filtering and saving command output, see the [“Getting Started with AlliedWare Plus” Feature Overview and Configuration Guide](#).

Syntax `show ip ospf database opaque-link [<ip-address>]
[self-originate|<advrouter>]`

Parameter	Description
<advrouter>	adv-router <ip-address>
adv-router	Displays all the LSAs of the specified router.
<ip-address>	A link state ID, as an IP address.
self-originate	Displays self-originated link states.

Mode User Exec and Privileged Exec

Examples

```
awplus# show ip ospf database opaque-link 1.2.3.4  
self-originate  
  
awplus# show ip ospf database opaque-link self-originate  
  
awplus# show ip ospf database opaque-link 1.2.3.4 adv-router  
2.3.4.5
```

Output Figure 27-12: Example output from the **show ip ospf database opaque-link** command

```
OSPF Router process 100 with ID (10.10.11.50)  
    Link-Local Opaque-LSA (Link hme0:10.10.10.50)  
LS age: 276  
Options: 0x2 (*|-|-|-|-|E|-)  
LS Type: Link-Local Opaque-LSA  
Link State ID: 10.0.220.247 (Link-Local Opaque-Type/ID)  
Opaque Type: 10  
Opaque ID: 56567  
Advertising Router: 10.10.11.50  
LS Seq Number: 80000001  
Checksum: 0x744e  
Length: 26  
    Link-Local Opaque-LSA (Link hme1:10.10.11.50)
```

show ip ospf database router

Overview Use this command to display information only about the router LSAs.

For information on filtering and saving command output, see the [“Getting Started with AlliedWare Plus” Feature Overview and Configuration Guide](#).

Syntax `show ip ospf database router [<adv-router-id>
self-originate|<adv-router-id>]`

Parameter	Description
<code>adv-router</code>	Displays all the LSAs of the specified router.
<code>self-originate</code>	Displays self-originated link states.
<code><adv-router- id></code>	The router ID of the advertising router, in IPv4 address format. Note however, that this no longer represents a real address.

Mode User Exec and Privileged Exec

Examples

```
awplus# show ip ospf database router 1.2.3.4 self-originate
awplus# show ip ospf database router self-originate
awplus# show ip ospf database router 1.2.3.4 adv-router 2.3.4.5
```

Output Figure 27-13: Example output from the **show ip ospf database router** command

```
OSPF Router process 100 with ID (10.10.11.50)
Router Link States (Area 0.0.0.0)
LS age: 878
Options: 0x2 (*|-|-|-|-|E|-)
Flags: 0x3 : ABR ASBR
LS Type: router-LSA
Link State ID: 10.10.11.50
Advertising Router: 10.10.11.50
LS Seq Number: 80000004
Checksum: 0xe39e
Length: 36
Number of Links: 1
Link connected to: Stub Network
(Link ID) Network/subnet number: 10.10.10.0
(Link Data) Network Mask: 255.255.255.0
Number of TOS metrics: 0
TOS 0 Metric: 10
```

```
Router Link States (Area 0.0.0.1)
LS age: 877
Options: 0x2 (*|---|E|)
Flags: 0x3 : ABR ASBR
LS Type: router-LSA
Link State ID: 10.10.11.50
Advertising Router: 10.10.11.50
LS Seq Number: 80000003
Checksum: 0xee93
Length: 36
Number of Links: 1
  Link connected to: Stub Network
    (Link ID) Network/subnet number: 10.10.11.0
    (Link Data) Network Mask: 255.255.255.0
  Number of TOS metrics: 0
    TOS 0 Metric: 10
```

show ip ospf database summary

Overview Use this command to display information about the summary LSAs.

For information on filtering and saving command output, see the [“Getting Started with AlliedWare Plus” Feature Overview and Configuration Guide](#).

Syntax `show ip ospf database summary [<ip-address>]
[self-originate|<advrouter>]`

Parameter	Description
<advrouter>	adv-router <ip-address>
adv-router	Displays all the LSAs of the specified router.
<ip-address>	A link state ID, as an IP address.
self-originate	Displays self-originated link states.

Mode User Exec and Privileged Exec

Examples `awplus# show ip ospf database summary 1.2.3.4 self-originate`
`awplus# show ip ospf database summary self-originate`
`awplus# show ip ospf database summary 1.2.3.4 adv-router 2.3.4.5`

Output Figure 27-14: Example output from the **show ip ospf database summary** command

```
OSPF Router process 100 with ID (10.10.11.50)
  Summary Link States (Area 0.0.0.0)
  Summary Link States (Area 0.0.0.1)
LS age: 1124
Options: 0x2 (*|-|-|-|-|E|-)
LS Type: summary-LSA
Link State ID: 10.10.10.0 (summary Network Number)
Advertising Router: 10.10.11.50
LS Seq Number: 80000001
Checksum: 0x41a2
Length: 28
Network Mask: /24
  TOS: 0 Metric: 10
```

Figure 27-15: Example output from the **show ip ospf database summary self-originate** command

```
OSPF Router process 100 with ID (10.10.11.50)
  Summary Link States (Area 0.0.0.0)
LS age: 1061
Options: 0x2 (*|-|-|-|-|E|-)
LS Type: summary-LSA
Link State ID: 10.10.11.0 (summary Network Number)
Advertising Router: 10.10.11.50
LS Seq Number: 80000001
Checksum: 0x36ac
Length: 28
Network Mask: /24
  TOS: 0 Metric: 10
  Summary Link States (Area 0.0.0.1)
LS age: 1061
Options: 0x2 (*|-|-|-|-|E|-)
LS Type: summary-LSA
Link State ID: 10.10.11.0 (summary Network Number)
Advertising Router: 10.10.11.50
LS Seq Number: 80000001
Checksum: 0x36ac
Length: 28
Network Mask: /24
  TOS: 0 Metric: 10
  Summary Link States (Area 0.0.0.1)
LS age: 1061
Options: 0x2 (*|-|-|-|-|E|-)
LS Type: summary-LSA
Link State ID: 10.10.10.0 (summary Network Number)
Advertising Router: 10.10.11.50
LS Seq Number: 80000001
Checksum: 0x41a2
Length: 28
Network Mask: /24
  TOS: 0 Metric: 10
```

Figure 27-16: Example output from the **show ip ospf database summary adv-router <ip-address>** command

```
OSPF Router process 100 with ID (10.10.11.50)
  Summary Link States (Area 0.0.0.0)
LS age: 989
Options: 0x2 (*|---|---|E|)
LS Type: summary-LSA
Link State ID: 10.10.11.0 (summary Network Number)
Advertising Router: 10.10.11.50
LS Seq Number: 80000001
Checksum: 0x36ac
Length: 28
Network Mask: /24
  TOS: 0 Metric: 10
  Summary Link States (Area 0.0.0.1)
LS age: 989
Options: 0x2 (*|---|---|E|)
LS Type: summary-LSA
Link State ID: 10.10.11.0 (summary Network Number)
Advertising Router: 10.10.11.50
LS Seq Number: 80000001
Checksum: 0x36ac
Length: 28
Network Mask: /24
  TOS: 0 Metric: 10
```

show ip ospf interface

Overview Use this command to display interface information for OSPF.

For information on filtering and saving command output, see the [“Getting_Started with AlliedWare Plus” Feature Overview and Configuration_Guide](#).

Syntax `show ip ospf interface [<interface-list>]`

Parameter	Description
<code><interface-list></code>	<p>The interfaces to display information about. An interface-list can be:</p> <ul style="list-style-type: none">• a PPP interface (e.g. ppp0)• an Eth interface (e.g. eth1)• an 802.1Q Ethernet sub-interface (e.g. eth1.10, where '10' is the VLAN ID specified by the encapsulation dot1q command)• a VLAN (e.g. vlan2)• a bridge interface (e.g. br0)• a tunnel interface (e.g. tunnel0)• a WWAN interface (e.g. wwan0)• the loopback interface (lo)• a continuous range of interfaces, separated by a hyphen (e.g. ppp2-4)• a comma-separated list (e.g. ppp0,ppp2-4). Do not mix interface types in a list.

Mode User Exec and Privileged Exec

Examples `awplus# show ip ospf interface tunnel14`

Output Figure 27-17: Example output from the **show ip ospf interface** command

```
awplus#show ip ospf interface
tunnel14 is up, line protocol is up
 Internet Address 192.168.100.5/30, Area 0.0.0.200, MTU 1438
 Interface state Point-To-Point
 Process ID 200, Router ID 10.255.255.1, Network Type POINTOPOINT, Cost: 1
 Transmit Delay is 1 sec, State Point-To-Point
 Timer intervals configured, Hello 10, Dead 40, Wait 40, Retransmit 5
   Hello due in 00:00:06
 Neighbor Count is 1, Adjacent neighbor count is 0
 Crypt Sequence Number is 237068
 Hello received 1211 sent 1259, DD received 9 sent 20
 LS-Req received 3 sent 2, LS-Upd received 19 sent 231
 LS-Ack received 218 sent 17, Discarded 0
```

show ip ospf neighbor

Overview Use this command to display information on OSPF neighbors. Include the **ospf-id** parameter with this command to display information about specified instances.

For information on filtering and saving command output, see the [“Getting Started with AlliedWare Plus” Feature Overview and Configuration Guide](#).

Syntax show ip ospf [*<ospf-id>*] neighbor *<neighbor-ip-addr>* [detail]
show ip ospf [*<ospf-id>*] neighbor detail [all]
show ip ospf [*<ospf-id>*] neighbor [all]
show ip ospf [*<ospf-id>*] neighbor interface *<ip-addr>*

Parameter	Description
<i><ospf-id></i>	<i><0-65535></i> The ID of the router process for which information will be displayed.
<i><neighbor-ip-addr></i>	The Neighbor ID, entered as an IP address.
all	Include downstatus neighbor.
detail	Detail of all neighbors.
<i><ip-addr></i>	IP address of the interface.

Mode User Exec and Privileged Exec

Examples awplus# show ip ospf neighbor detail
awplus# show ip ospf neighbor 1.2.3.4
awplus# show ip ospf neighbor interface 10.10.10.50 detail all

Output Note that before a device enters OSPF Graceful Restart it first informs its OSPF neighbors. In the **show** output, an * symbol beside the **Dead Time** parameter indicates that the device has been notified of a neighbor entering the graceful restart state.

Figure 27-18: Example output from the **show ip ospf neighbor** command

```
awplus#show ip ospf neighbor

OSPF process 200:
Neighbor ID    Pri   State           Dead Time   Address        Interface
192.168.100.22  1     Full/ -         00:00:32   192.168.100.18 tunnel16
...
```

Figure 27-19: Example output from the **show ip ospf <ospf-id> neighbor** command

```
awplus#show ip ospf 200 neighbor

OSPF process 200:
Neighbor ID      Pri   State           Dead Time   Address        Interface
192.168.100.22  1    Full/ -         00:00:32   192.168.100.18 tunnel16
```

Figure 27-20: Example output from the **show ip ospf neighbor detail** command

```
awplus#show ip ospf neighbor detail
Neighbor 192.168.100.22, interface address 192.168.100.18
  In the area 0.0.0.200 via interface tunnel16
  Neighbor priority is 1, State is Full, 5 state changes
  DR is 0.0.0.0, BDR is 0.0.0.0
  Options is 0x42 (-|O|-|-|-|E|-)
  Dead timer due in 00:00:34
  Neighbor is up for 02:08:06
  Database Summary List 0
  Link State Request List 0
  Link State Retransmission List 0
  Crypt Sequence Number is 0
  Thread Inactivity Timer on
  Thread Database Description Retransmission off
  Thread Link State Request Retransmission off
  Thread Link State Update Retransmission off
```

show ip ospf route

Overview Use this command to display the OSPF routing table. Include the **ospf-id** parameter with this command to display the OSPF routing table for specified instances.

For information on filtering and saving command output, see the [“Getting Started with AlliedWare Plus” Feature Overview and Configuration Guide](#).

Syntax `show ip ospf [<ospf-id>] route`

Parameter	Description
<ospf-id>	<0-65535> The ID of the router process for which information will be displayed. If this parameter is included, only the information for this specified routing process is displayed.

Mode User Exec and Privileged Exec

Examples To display the OSPF routing table, use the command:

```
awplus# show ip ospf route
```

Output Figure 27-21: Example output from the **show ip ospf route** command for a specific process

```
awplus#show ip ospf route

OSPF process 200:
Codes: C - connected, D - Discard, O - OSPF, IA - OSPF inter area
       N1 - OSPF NSSA external type 1, N2 - OSPF NSSA external type 2
       E1 - OSPF external type 1, E2 - OSPF external type 2

O 172.30.1.64/26 [2] via 192.168.100.6, tunnel104, Area 0.0.0.200
O 172.30.2.64/26 [2] via 192.168.100.18, tunnel116, Area 0.0.0.200
O 172.30.4.0/24 [2] via 192.168.100.6, tunnel104, Area 0.0.0.200
C 192.168.100.4/30 [1] is directly connected, tunnel104, Area 0.0.0.200
C 192.168.100.16/30 [1] is directly connected, tunnel116, Area 0.0.0.200
```

show ip ospf virtual-links

Overview Use this command to display virtual link information.

For information on filtering and saving command output, see the [“Getting Started with AlliedWare Plus” Feature Overview and Configuration Guide](#).

Syntax `show ip ospf virtual-links`

Mode User Exec and Privileged Exec

Examples To display virtual link information, use the command:

```
awplus# show ip ospf virtual-links
```

Output Figure 27-22: Example output from the **show ip ospf virtual-links** command

```
awplus#show ip ospf virtual-links
Virtual Link VLINK0 to router 10.10.0.9 is up
  Transit area 0.0.0.1 via interface eth1
  Transmit Delay is 1 sec, State Point-To-Point,
  Timer intervals configured, Hello 10, Dead 40, Wait 40,
  Retransmit 5
  Hello due in 00:00:02
  Adjacency state Full
Virtual Link VLINK1 to router 10.10.0.123 is down
  Transit area 0.0.0.1 via interface *
  Transmit Delay is 1 sec, State Down,
  Timer intervals configured, Hello 10, Dead 40, Wait 40,
  Retransmit 5
  Hello due in inactive
  Adjacency state Down
```

show ip protocols ospf

Overview Use this command to display OSPF process parameters and statistics.
For information on filtering and saving command output, see the [“Getting Started with AlliedWare Plus” Feature Overview and Configuration Guide](#).

Syntax `show ip protocols ospf`

Mode User Exec and Privileged Exec

Examples To display OSPF process parameters and statistics, use the command:

```
awplus# show ip protocols ospf
```

Output Figure 27-23: Example output from the **show ip protocols ospf** command

```
Routing Protocol is "ospf 200"
  Invalid after 0 seconds, hold down 0, flushed after 0
  Outgoing update filter list for all interfaces is
    Redistributed kernel filtered by filter1
  Incoming update filter list for all interfaces is
  Redistributing: kernel
  Routing for Networks:
    192.30.30.0/24
    192.40.40.0/24
  Routing Information Sources:
    Gateway          Distance      Last Update
  Distance: (default is 110)
    Address          Mask          Distance List
```

summary-address

Overview Use this command to summarize, or possibly suppress, external routes that have the specified address range.

Use the **no** variant of this command to stop summarizing, or suppressing, external routes that have the specified address range.

Syntax `summary-address <ip-addr/prefix-length> [not-advertise] [tag <0-4294967295>]`
`no summary-address <ip-addr/prefix-length> [not-advertise] [tag <0-4294967295>]`

Parameter	Description
<code><ip-addr/prefix-length></code>	Specifies the base IP address of the summary address. The range of addresses given as IPv4 starting address and a prefix length.
<code>not-advertise</code>	Set the not-advertise option if you do not want OSPF to advertise either the summary address or the individual networks within the range of the summary address.
<code>tag <0-4294967295></code>	The tag parameter specifies the tag value that OSPF places in the AS external LSAs created as a result of redistributing the summary route. The tag overrides tags set by the original route.

Default The default tag value for a summary address is 0.

Mode Router Configuration

Usage notes An address range is a pairing of an address and a mask that is almost the same as IP network number. For example, if the specified address range is 192.168.0.0/255.255.240.0, it matches: 192.168.1.0/24, 192.168.4.0/22, 192.168.8.128/25 and so on.

Redistributing routes from other protocols into OSPF requires the router to advertise each route individually in an external LSA. Use the **summary address** command to advertise one summary route for all redistributed routes covered by a specified network address and mask. This helps decrease the size of the OSPF link state database.

Ensure OSPF routes exist in the summary address range for advertisement before using this command.

Example The following example uses the **summary-address** command to aggregate external LSAs that match the network 172.16.0.0/16 and assign a Tag value of 3.

```
awplus# configure terminal
awplus(config)# router ospf 100
awplus(config-router)# summary-address 172.16.0.0/16 tag 3
```

timers spf exp

Overview Use this command to adjust route calculation timers using exponential back-off delays.

Use **no** form of this command to return to the default exponential back-off timer values.

Syntax `timers spf exp <min-holdtime> <max-holdtime>`
`no timers spf exp`

Parameter	Description
<code><min-holdtime></code>	<code><0-2147483647></code> Specifies the minimum delay between receiving a change to the SPF calculation in milliseconds. The default SPF min-holdtime value is 50 milliseconds.
<code><max-holdtime></code>	<code><0-2147483647></code> Specifies the maximum delay between receiving a change to the SPF calculation in milliseconds. The default SPF max-holdtime value is 50 seconds.

Mode Router Configuration

Default The default SPF min-holdtime is 50 milliseconds. The default SPF max-holdtime is 40 seconds.

Usage This command configures the minimum and maximum delay time between the receipt of a topology change and the calculation of the Shortest Path First (SPF).

Examples To set the minimum delay time to 5 milliseconds and maximum delay time to 10 milliseconds, use the commands:

```
awplus# configure terminal
awplus(config)# router ospf 100
awplus(config-router)# timers spf exp 5 10
```

To reset the minimum and maximum delay times to the default values, use the commands:

```
awplus# configure terminal
awplus(config)# router ospf 100
awplus(config-router)# no timers spf exp
```

Related commands [timers spf exp](#)

undebbug ospf events

Overview This command applies the functionality of the no `debug ospf events` command.

undebbug ospf ifsm

Overview This command applies the functionality of the no `debug ospf ifsm` command.

undebbug ospf lsa

Overview This command applies the functionality of the no `debug ospf lsa` command.

undebbug ospf nfsm

Overview This command applies the functionality of the no `debug ospf nfsm` command.

undebbug ospf nsm

Overview This command applies the functionality of the no `debug ospf nsm` command.

undebbug ospf packet

Overview This command applies the functionality of the no `debug ospf packet` command.

undebg ospf route

Overview This command applies the functionality of the no `debug ospf route` command.

28

OSPFv3 for IPv6 Commands

Introduction

Overview This chapter provides an alphabetical reference of commands used to configure OSPFv3 for IPv6. See the [OSPFv3 Feature Overview and Configuration Guide](#) for more information and examples.

- Command List**
- [“abr-type”](#) on page 1143
 - [“area authentication ipsec spi”](#) on page 1144
 - [“area default-cost \(IPv6 OSPF\)”](#) on page 1146
 - [“area encryption ipsec spi esp”](#) on page 1147
 - [“area range \(IPv6 OSPF\)”](#) on page 1150
 - [“area stub \(IPv6 OSPF\)”](#) on page 1152
 - [“area virtual-link \(IPv6 OSPF\)”](#) on page 1153
 - [“area virtual-link authentication ipsec spi”](#) on page 1155
 - [“area virtual-link encryption ipsec spi”](#) on page 1157
 - [“auto-cost reference bandwidth \(IPv6 OSPF\)”](#) on page 1160
 - [“bandwidth”](#) on page 1162
 - [“clear ipv6 ospf process”](#) on page 1163
 - [“debug ipv6 ospf events”](#) on page 1164
 - [“debug ipv6 ospf ifsm”](#) on page 1165
 - [“debug ipv6 ospf lsa”](#) on page 1166
 - [“debug ipv6 ospf n fsm”](#) on page 1167
 - [“debug ipv6 ospf packet”](#) on page 1168
 - [“debug ipv6 ospf route”](#) on page 1169
 - [“default-information originate”](#) on page 1170

- [“default-metric \(IPv6 OSPF\)”](#) on page 1171
- [“distance \(IPv6 OSPF\)”](#) on page 1172
- [“ipv6 ospf authentication spi”](#) on page 1174
- [“ipv6 ospf cost”](#) on page 1176
- [“ipv6 ospf dead-interval”](#) on page 1177
- [“ipv6 ospf display route single-line”](#) on page 1178
- [“ipv6 ospf encryption spi esp”](#) on page 1179
- [“ipv6 ospf hello-interval”](#) on page 1182
- [“ipv6 ospf neighbor”](#) on page 1183
- [“ipv6 ospf network”](#) on page 1185
- [“ipv6 ospf priority”](#) on page 1186
- [“ipv6 ospf retransmit-interval”](#) on page 1187
- [“ipv6 ospf transmit-delay”](#) on page 1188
- [“ipv6 router ospf area”](#) on page 1189
- [“max-concurrent-dd \(IPv6 OSPF\)”](#) on page 1191
- [“passive-interface \(IPv6 OSPF\)”](#) on page 1192
- [“redistribute \(IPv6 OSPF\)”](#) on page 1193
- [“restart ipv6 ospf graceful”](#) on page 1195
- [“router ipv6 ospf”](#) on page 1196
- [“router-id \(IPv6 OSPF\)”](#) on page 1197
- [“show debugging ipv6 ospf”](#) on page 1198
- [“show ipv6 ospf”](#) on page 1199
- [“show ipv6 ospf database”](#) on page 1201
- [“show ipv6 ospf database external”](#) on page 1202
- [“show ipv6 ospf database grace”](#) on page 1203
- [“show ipv6 ospf database inter-prefix”](#) on page 1204
- [“show ipv6 ospf database inter-router”](#) on page 1205
- [“show ipv6 ospf database intra-prefix”](#) on page 1206
- [“show ipv6 ospf database link”](#) on page 1207
- [“show ipv6 ospf database network”](#) on page 1208
- [“show ipv6 ospf database router”](#) on page 1210
- [“show ipv6 ospf interface”](#) on page 1215
- [“show ipv6 ospf neighbor”](#) on page 1216
- [“show ipv6 ospf route”](#) on page 1217
- [“show ipv6 ospf virtual-links”](#) on page 1218

- [“summary-address \(IPv6 OSPF\)”](#) on page 1219
- [“timers spf exp \(IPv6 OSPF\)”](#) on page 1221
- [“undebug ipv6 ospf events”](#) on page 1222
- [“undebug ipv6 ospf ifsm”](#) on page 1223
- [“undebug ipv6 ospf lsa”](#) on page 1224
- [“undebug ipv6 ospf n fsm”](#) on page 1225
- [“undebug ipv6 ospf packet”](#) on page 1226
- [“undebug ipv6 ospf route”](#) on page 1227

abr-type

Overview Use this command to set an OSPF Area Border Router (ABR) type.

Use the **no** variant of this command to revert the ABR type to the default setting (cisco).

Syntax `abr-type {cisco|ibm|standard}`
`no abr-type {cisco|ibm|standard}`

Parameter	Description
cisco	Specifies an alternative ABR using Cisco implementation (RFC 3509). This is the default ABR type.
ibm	Specifies an alternative ABR using IBM implementation (RFC 3509).
standard	Specifies a standard behavior ABR (RFC 2328).

Default ABR type cisco

Mode Router Configuration

Usage notes Specifying the ABR type allows better interoperability between different implementations. This command is especially useful in a multi-vendor environment. The different ABR types are:

- Cisco ABR Type: By this definition, a router is considered an ABR if it has more than one area actively attached and one of them is the backbone area.
- IBM ABR Type: By this definition, a router is considered an ABR if it has more than one area actively attached and the backbone area is configured. In this case the configured backbone need not be actively connected.
- Standard ABR Type: By this definition, a router is considered an ABR if it has more than one area actively attached to it.

Example To set the ABR type to "ibm" use the following commands:

```
awplus# configure terminal
awplus(config)# router ipv6 ospf 100
awplus(config-router)# abr-type ibm
```

area authentication ipsec spi

Overview Use this command in Router Configuration mode to enable either MD5 (Message-Digest 5) or SHA1 (Secure Hash Algorithm 1) authentication for a specified OSPF area.

Use the **no** variant of this command in Router Configuration mode to disable the authentication configured for a specified OSPF area.

Syntax `area <area-id> authentication ipsec spi <256-4294967295> {md5 <MD5-key>|sha1 <SHA1-key>}`
`no area <area-id> authentication ipsec spi <256-4294967295>`

Parameter	Description				
<area-id>	The OSPF area that you are specifying the summary route default-cost for. This can be entered in either dotted decimal format or normal decimal format. Use one of the following formats: <table border="1"><tr><td><ip-addr></td><td>OSPF area-ID expressed in IPv4 address format A.B.C.D.</td></tr><tr><td><0-4294967295></td><td>OSPF area-ID expressed as a decimal number within the range shown.</td></tr></table> For example, the values 0.0.1.2 and decimal 258 would both define the same area-ID.	<ip-addr>	OSPF area-ID expressed in IPv4 address format A.B.C.D.	<0-4294967295>	OSPF area-ID expressed as a decimal number within the range shown.
<ip-addr>	OSPF area-ID expressed in IPv4 address format A.B.C.D.				
<0-4294967295>	OSPF area-ID expressed as a decimal number within the range shown.				
<256-4294967295>	Specify an SPI (Security Parameters Index) value in the range 256 to 4294967295, entered as a decimal integer.				
md5	Specify the MD5 (Message-Digest 5) hashing algorithm.				
<MD5-key>	Enter an MD5 key containing up to 32 hexadecimal characters.				
sha1	Specify the SHA-1 (Secure Hash Algorithm 1) hashing algorithm.				
<SHA1-key>	Enter an SHA-1 key containing up to 40 hexadecimal characters.				

Mode Router Configuration

Usage notes Use this command on an OSPFv3 area; use the [area virtual-link authentication ipsec spi](#) command on an OSPFv3 area virtual link. Configure the same SPI (Security Parameters Index) value on all interfaces that connect to the same link. SPI values are used by link interfaces. Use a different SPI value for a different link interface when using OSPFv3 with link interfaces.

Use the **sha1** keyword to choose SHA-1 authentication instead of entering the **md5** keyword to use MD5 authentication. The SHA-1 algorithm is more secure than the MD5 algorithm. SHA-1 uses a 40 hexadecimal character key instead of a 32 hexadecimal character key as used for MD5 authentication.

See the [OSPFv3 Feature Overview and Configuration Guide](#) for more information and examples.

NOTE: You can configure an authentication security policy (SPI) on an OSPFv3 area with this command, or on an interface with the [ipv6 ospf authentication spi](#) command.

When you configure authentication for an area, the security policy is applied to all interfaces in the area. However, we recommend a different authentication security policy is applied to each interface for higher security.

If you apply the **ipv6 ospf authentication null** command, this affects authentication configured on both the interface and the OSPFv3 area.

This is due to OSPFv3 hello messages ingressing interfaces, which are part of area authentication, not being authenticated. So neighbors time out.

Example To enable MD5 authentication with a 32 hexadecimal character key for OPSPF area 1, use the commands:

```
awplus# configure terminal
awplus(config)# router ipv6 ospf
awplus(config-router)# area 1 authentication ipsec spi 1000 md5
1234567890ABCDEF1234567890ABCDEF
```

To enable SHA-1 authentication with a 40 hexadecimal character key for OPSPF area 1, use the commands:

```
awplus# configure terminal
awplus(config)# router ipv6 ospf
awplus(config-router)# area 1 authentication ipsec spi 1000
sha1 1234567890ABCDEF1234567890ABCDEF12345678
```

To disable authentication for OPSPF area 1, use the commands:

```
awplus# configure terminal
awplus(config)# router ipv6 ospf
awplus(config-router)# no area 1 authentication ipsec spi 1000
```

Related commands

- [area encryption ipsec spi esp](#)
- [area virtual-link authentication ipsec spi](#)
- [area virtual-link encryption ipsec spi](#)
- [ipv6 ospf authentication spi](#)
- [ipv6 ospf encryption spi esp](#)
- [show ipv6 ospf](#)

area default-cost (IPv6 OSPF)

Overview This command specifies a cost for the default summary route sent into a stub area. The **no** variant of this command removes the assigned default-route cost.

Syntax `area <area-id> default-cost <0-16777215>`
`no area <area-id> default-cost`

Parameter	Description				
<area-id>	The OSPF area that you are specifying the summary route default-cost for. This can be entered in either dotted decimal format or normal decimal format. Use one of the following formats: <table border="1"><tbody><tr><td><ip-addr></td><td>OSPF area-ID expressed in IPv4 address format A.B.C.D.</td></tr><tr><td><0-4294967295></td><td>OSPF area-ID expressed as a decimal number within the range shown.</td></tr></tbody></table> For example, the values 0.0.1.2 and decimal 258 would both define the same area-ID.	<ip-addr>	OSPF area-ID expressed in IPv4 address format A.B.C.D.	<0-4294967295>	OSPF area-ID expressed as a decimal number within the range shown.
<ip-addr>	OSPF area-ID expressed in IPv4 address format A.B.C.D.				
<0-4294967295>	OSPF area-ID expressed as a decimal number within the range shown.				
default-cost	Indicates the cost for the default summary route used for a stub area. Default: 1				

Mode Router Configuration

Usage The default-cost option provides the metric for the summary default route, generated by the area border router, into the stub area. Use this option only on an area border router that is attached to the stub area.

Example To set the default cost to 10 in area 1 for the OSPF process P2, use the commands:

```
awplus# configure terminal
awplus(config)# router ipv6 ospf P2
awplus(config-router)# area 1 default-cost 10
```

Related commands [area stub \(IPv6 OSPF\)](#)

area encryption ipsec spi esp

Overview Use this command in Router Configuration mode to enable either AES-CBC (Advanced Encryption Standard-Cipher Block Chaining) or 3DES (Triple Data Encryption Standard) ESP (Encapsulating Security Payload) encryption for a specified OSPF area.

Use the **no** variant of this command in Router Configuration mode to disable the encryption configured for a specified OSPF area.

Syntax

```
area <area-id> encryption ipsec spi <256-4294967295> esp
{aes-cbc <AES-CBC-key>|3des <3DES-key>|null}{md5
<MD5-key>|sha1 <SHA1-key>}
no area <area-id> encryption ipsec spi <256-4294967295>
```

Parameter	Description				
<area-id>	The OSPF area that you are specifying the summary route default-cost for. This can be entered in either dotted decimal format or normal decimal format. Use one of the following formats: <table border="1" style="width: 100%; border-collapse: collapse;"> <tr> <td style="width: 30%; text-align: center;"><ip-addr></td> <td>OSPF area-ID expressed in IPv4 address format A.B.C.D.</td> </tr> <tr> <td style="width: 30%; text-align: center;"><0-4294967295></td> <td>OSPF area-ID expressed as a decimal number within the range shown.</td> </tr> </table> For example, the values 0.0.1.2 and decimal 258 would both define the same area-ID.	<ip-addr>	OSPF area-ID expressed in IPv4 address format A.B.C.D.	<0-4294967295>	OSPF area-ID expressed as a decimal number within the range shown.
<ip-addr>	OSPF area-ID expressed in IPv4 address format A.B.C.D.				
<0-4294967295>	OSPF area-ID expressed as a decimal number within the range shown.				
<256-4294967295>	Specify an SPI (Security Parameters Index) value in the range 256 to 4294967295, entered as a decimal integer.				
esp	Specify the esp keyword (Encapsulating Security Payload) to then apply either AES-CBC or 3DES encryption.				
aes-cbc	Specify this keyword to enable AES-CBC (Advanced Encryption Standard-Cipher Block Chaining) encryption.				
<AES-CBC-key>	Enter an AES-CBC key containing either 32, 48, or 64 hexadecimal characters.				
3des	Specify 3DES (Triple Data Encryption Standard) encryption.				
<3DES-key>	Enter a 3DES key containing 48 hexadecimal characters.				
null	Specify ESP without AES-CBC or 3DES encryption applied.				
md5	Specify the MD5 (Message-Digest 5) encryption algorithm.				
<MD5-key>	Enter an MD5 key containing 32 hexadecimal characters.				
sha1	Specify the SHA-1 (Secure Hash Algorithm 1) encryption algorithm.				
<SHA1-key>	Enter an SHA-1 key containing 40 hexadecimal characters.				

Mode Router Configuration

Usage notes When you issue this command, authentication and encryption are both enabled.

Use this command on an OSPFv3 area, use the [area virtual-link encryption ipsec spi](#) command on an OSPFv3 area virtual link. Configure the same SPI (Security Parameters Index) value on all interfaces that connect to the same link. SPI values are used by link interfaces. Use a different SPI value for a different link interface when using OSPFv3 with link interfaces.

Security is achieved using the IPv6 ESP extension header. The IPv6 ESP extension header is used to provide confidentiality, integrity, authentication, and confidentiality. Authentication fields are removed from OSPF for IPv6 packet headers, so applying IPv6 ESP extension headers are required for integrity, authentication, and confidentiality.

Use the **sha1** keyword to choose SHA-1 authentication instead of entering the **md5** keyword to use MD5 authentication. The SHA-1 algorithm is more secure than the MD5 algorithm. SHA-1 uses a 40 hexadecimal character key instead of a 32 hexadecimal character key as used for MD5 authentication.

See the [OSPFv3 Feature Overview and Configuration Guide](#) for more information and examples.

NOTE: You can configure an encryption security policy (SPI) on an OSPFv3 area with this command, or on an interface with the [ipv6 ospf encryption spi esp](#) command.

When you configure encryption for an area, the security policy is applied to all interfaces in the area. However, we recommend a different encryption security policy is applied to each interface for higher security.

If you apply the **ipv6 ospf encryption null** command, this affects encryption configured on both the interface and the OSPFv3 area.

This is due to OSPFv3 hello messages ingressing interfaces, which are part of area encryption, not being encrypted. So neighbors time out.

Example To enable ESP encryption, but not apply an AES-CBC key or an 3DES key, and MD5 authentication with a 32 hexadecimal character key for OPSPF area 1, use the commands:

```
awplus# configure terminal
awplus(config)# router ipv6 ospf
awplus(config-router)# area 1 encryption ipsec spi 1000 esp null
md5 1234567890ABCDEF1234567890ABCDEF
```

To enable ESP encryption, but not apply an AES-CBC key or an 3DES key, and SHA-1 authentication with a 40 hexadecimal character key for OPSPF area 1, use the commands:

```
awplus# configure terminal
awplus(config)# router ipv6 ospf
awplus(config-router)# area 1 encryption ipsec spi 1000 esp null
sha1 1234567890ABCDEF1234567890ABCDEF12345678
```

To enable ESP encryption with a 48 hexadecimal character 3DES key and a 32 hexadecimal character MD5 authentication for OSPF area 1, use the commands:

```
awplus# configure terminal
awplus(config)# router ipv6 ospf
awplus(config-router)# area 1 encryption ipsec spi 1000 esp 3des
1234567890ABCDEF1234567890ABCDEF1234567890ABCDEF md5
1234567890ABCDEF1234567890ABCDEF
```

To enable ESP encryption with a 32 hexadecimal character AES-CBC key, and a 40 hexadecimal character SHA-1 authentication key for OSPF area 1, use the commands:

```
awplus# configure terminal
awplus(config)# router ipv6 ospf
awplus(config-router)# area 1 encryption ipsec spi 1000 esp
aes-cbc 1234567890ABCDEF1234567890ABCDEF sha1
1234567890ABCDEF1234567890ABCDEF12345678
```

To disable ESP encryption for OSPF area 1, use the commands:

```
awplus# configure terminal
awplus(config)# router ipv6 ospf
awplus(config-router)# no area 1 encryption ipsec spi 1000
```

**Related
commands**

[area authentication ipsec spi](#)
[area virtual-link authentication ipsec spi](#)
[area virtual-link encryption ipsec spi](#)
[ipv6 ospf authentication spi](#)
[ipv6 ospf encryption spi esp](#)
[show ipv6 ospf](#)

area range (IPv6 OSPF)

Overview Use this command to summarize OSPFv3 routes at an area boundary, configuring an IPv6 address range which consolidates OSPFv3 routes. By default, this feature is not enabled.

A summary route created by this command is then advertised to other areas by the Area Border Routers (ABRs). In this way, routing information is condensed at area boundaries and outside the area so that routes are exchanged between areas in an efficient manner.

If the network numbers in an area are arranged into sets of contiguous routes, the ABRs can be configured to advertise a summary route that covers all the individual networks within the area that fall into the specified range.

The **no** variant of this command disables this function and restores default behavior.

Syntax `area <area-id> range <ipv6address/prefix-length> [advertise|not-advertise]`
`no area <area-id> range <ipv6address/prefix-length>`

Parameter	Description
<code><area-id></code>	The OSPFv3 area that you summarizing the routes for. Use one of the following formats: This can be entered in either dotted decimal format or normal decimal format. <code><A.B.C.D></code> OSPF area-ID expressed in IPv4 address format A.B.C.D. <code><0-4294967295></code> OSPF area-ID expressed as a decimal number within the range shown. For example the values 0.0.1.2 and decimal 258 would both define the same area-ID.
<code><ip-addr/prefix-length></code>	The IPv6 address uses the format X:X::X/X/Prefix-Length. The prefix-length is usually set between 0 and 64.
<code>advertise</code>	Advertise this range as a summary route into other areas.
<code>not-advertise</code>	Do not advertise this range.

Default The area range is not configured by default. The area range is advertised if it is configured.

Mode Router Configuration

Usage notes You can configure multiple ranges on a single area with multiple instances of this command, so OSPFv3 summarizes addresses for different sets of IPv6 address ranges.

Ensure OSPFv3 IPv6 routes exist in the area range for advertisement before using this command.

Example awplus# configure terminal
awplus(config)# router ipv6 ospf P2
awplus(config-router)# area 1 range 2000::/3

area stub (IPv6 OSPF)

Overview This command defines an OSPF area as a stub area. By default, no stub area is defined.

Use this command when routers in the area do not require learning about external LSAs. You can define the area as a totally stubby area by configuring the Area Border Router of that area using the **area stub no-summary** command.

The **no** variant of this command removes this definition.

Syntax `area <area-id> stub [no-summary]`
`no area <area-id> stub [no-summary]`

Parameter	Description
<area-id>	The OSPF area that you are configuring as a stub area. Use one of the following formats: This can be entered in either dotted decimal format or normal decimal format. For example the values dotted decimal 0.0.1.2 and decimal 258 would both define the same area-ID.
<A.B.C.D>	OSPF area-ID, expressed in the IPv4 address format <A.B.C.D>.
<0-4294967295>	OSPF area-ID expressed as a decimal number within the range shown.
	For example the values dotted decimal 0.0.1.2 and decimal 258 would both define the same area-ID.
no-summary	Stops an ABR from sending summary link advertisements into the stub area.

Mode Router Configuration

Usage There are two stub area router configuration commands: the **area stub** and **area default-cost** commands. In all routers attached to the stub area, configure the area by using the **area stub** command. For an area border router (ABR) attached to the stub area, also use the **area default-cost** command.

Example

```
awplus# configure terminal
awplus(config)# router ipv6 ospf 100
awplus(config-router)# area 100 stub
```

Related commands [area default-cost \(IPv6 OSPF\)](#)

area virtual-link (IPv6 OSPF)

Overview This command configures a link between a non-backbone area and the backbone, through other non-backbone areas.

In OSPF, all non-backbone areas must be connected to a backbone area. If the connection to the backbone is lost, the virtual link repairs the connection.

The **no** variant of this command removes the virtual link.

Syntax

```

area <area-id> virtual-link <router-id>
no area <area-id> virtual-link <router-id>
area <area-id> virtual-link <router-id>
no area <area-id> virtual-link <router-id>
area <area-id> virtual-link <router-id> [hello-interval
<1-65535>] [retransmit-interval <1-65535>] [transmit-delay
<1-65535>]
no area <area-id> virtual-link <router-id> [hello-interval]
[retransmit-interval] [transmit-delay]
```

Parameter	Description
<area-id>	The area-ID of the transit area that the virtual link passes through. This can be entered in either dotted decimal format or normal decimal format as shown below.
	<A.B.C.D> OSPF area-ID, expressed in the IPv4 address format <A.B.C.D>.
	<0-4294967295> OSPF area-ID expressed as a decimal number within the range shown.
	For example the values dotted decimal 0.0.1.2 and decimal 258 would both define the same area-ID.
<router-id>	The OSPF router ID of the virtual link neighbor.
dead-interval	If no packets are received from a particular neighbor for dead-interval seconds, the router considers the neighbor router to be off-line. Default: 40 seconds
	<1-65535> The number of seconds in the interval.
hello-interval	The interval the router waits before it sends a hello packet. Default: 10 seconds
	<1-65535> The number of seconds in the interval.
retransmit-interval	The interval the router waits before it retransmits a packet. Default: 5 seconds
	<1-65535> The number of seconds in the interval.

Parameter	Description
transmit-delay	The interval the router waits before it transmits a packet. Default: 1 seconds
<1-65535>	The number of seconds in the interval.

Mode Router Configuration

Usage You can configure virtual links between any two backbone routers that have an interface to a common non-backbone area. The protocol treats these two routers, joined by a virtual link, as if they were connected by an unnumbered point-to-point network. To configure a virtual link, you require:

- The transit area-ID, i.e. the area-ID of the non-backbone area that the two backbone routers are both connected to.
- The corresponding virtual link neighbor's router ID. To see the router ID use the [show ipv6 ospf](#) command.

Configure the **hello-interval** to be the same for all routers attached to a common network. A short **hello-interval** results in the router detecting topological changes faster but also an increase in the routing traffic.

The **retransmit-interval** is the expected round-trip delay between any two routers in a network. Set the value to be greater than the expected round-trip delay to avoid needless retransmissions.

The **transmit-delay** is the time taken to transmit a link state update packet on the interface. Before transmission, the link state advertisements in the update packet, are incremented by this amount. Set the **transmit-delay** to be greater than zero. Also, take into account the transmission and propagation delays for the interface.

Example To configure a virtual link through area 1 to the router with router-ID 10.10.11.50, use the following commands:

```
awplus# configure terminal
awplus(config)# router ipv6 ospf 100
awplus(config-router)# area 1 virtual-link 10.10.11.50 hello 5
dead 10
```

Related commands [show ipv6 ospf](#)

area virtual-link authentication ipsec spi

Overview Use this command in Router Configuration mode to enable authentication for virtual links in a specified OSPF area.

Use the **no** variant of this command in Router Configuration mode to disable authentication for virtual links in a specified OSPF area.

Syntax `area <area-id> virtual-link <router-ID> authentication ipsec spi <256-4294967295> {md5 <MD5-key>|sha1 <SHA1-key>}`
`no area <area-id> virtual-link <router-ID> authentication ipsec spi <256-4294967295>`

Parameter	Description				
<area-id>	The OSPF area that you are specifying the summary route default-cost for. This can be entered in either dotted decimal format or normal decimal format. Use one of the following formats: <table border="1"><tr><td><ip-addr></td><td>OSPF area-ID expressed in IPv4 address format A.B.C.D.</td></tr><tr><td><0-4294967295></td><td>OSPF area-ID expressed as a decimal number within the range shown.</td></tr></table> For example, the values 0.0.1.2 and decimal 258 would both define the same area-ID.	<ip-addr>	OSPF area-ID expressed in IPv4 address format A.B.C.D.	<0-4294967295>	OSPF area-ID expressed as a decimal number within the range shown.
<ip-addr>	OSPF area-ID expressed in IPv4 address format A.B.C.D.				
<0-4294967295>	OSPF area-ID expressed as a decimal number within the range shown.				
virtual-link	Specify a virtual link and its parameters.				
<router-ID>	Enter a router ID associated with a virtual link neighbor in IPv4 address format A.B.C.D.				
authentication	Specify this keyword to enable authentication.				
ipsec	Specify this keyword to use IPsec authentication.				
spi	Specify this keyword to set the SPI (Security Parameters Index).				
<256-4294967295>	Specify an SPI (Security Parameters Index) value in the range 256 to 4294967295, entered as a decimal integer.				
md5	Specify the MD5 (Message-Digest 5) encryption algorithm.				
<MD5-key>	Enter an MD5 key containing 32 hexadecimal characters.				
sha1	Specify the SHA-1 (Secure Hash Algorithm 1) encryption algorithm.				
<SHA1-key>	Enter an SHA-1 key containing 40 hexadecimal characters.				

Mode Router Configuration

Usage notes Use this command on an OSPFv3 area virtual link, use the [area authentication ipsec spi](#) command on an OSPFv3 area. Configure the same SPI (Security Parameters Index) value on all interfaces that connect to the same link. SPI values are used by

link interfaces. Use a different SPI value for a different link interface when using OSPFv3 with link interfaces.

OSPFv3 areas are connected to a backbone area. Virtual links can be configured to repair lost connections to a backbone area for OSPFv3 areas. To configure an OSPFv3 virtual link, use a router ID instead of the IPv6 prefix of the router.

Use the **sha1** keyword to choose SHA-1 authentication instead of entering the **md5** keyword to use MD5 authentication. The SHA-1 algorithm is more secure than the MD5 algorithm. SHA-1 uses a 40 hexadecimal character key instead of a 32 hexadecimal character key as used for MD5 authentication.

See the [OSPFv3 Feature Overview and Configuration Guide](#) for more information and examples.

Example To enable MD5 authentication with a 32 hexadecimal character key for virtual links in OSPF area 1, use the commands:

```
awplus# configure terminal
awplus(config)# router ipv6 ospf
awplus(config-router)# area 1 virtual-link 10.0.0.1
authentication ipsec spi 1000 md5
1234567890ABCDEF1234567890ABCDEF
```

To enable SHA-1 authentication with a 40 hexadecimal character key for virtual links in OSPF area 1, use the commands:

```
awplus# configure terminal
awplus(config)# router ipv6 ospf
awplus(config-router)# area 1 virtual-link 10.0.0.1
authentication ipsec spi 1000 sha1
1234567890ABCDEF1234567890ABCDEF12345678
```

To disable authentication for virtual links in OSPF area 1, use the commands:

```
awplus# configure terminal
awplus(config)# router ipv6 ospf
awplus(config-router)# no area 1 virtual-link ipsec spi 1000
```

Related commands

- [area authentication ipsec spi](#)
- [area encryption ipsec spi esp](#)
- [area virtual-link encryption ipsec spi](#)
- [show ipv6 ospf virtual-links](#)

area virtual-link encryption ipsec spi

Overview Use this command in Router Configuration mode to enable either AES-CBC (Advanced Encryption Standard-Cipher Block Chaining) or 3DES (Triple Data Encryption Standard) ESP (Encapsulating Security Payload) encryption for virtual links in a specified OSPF area.

Use the **no** variant of this command in Router Configuration mode to disable encryption configured for virtual links in a specified OSPF area.

Syntax

```
area <area-id> virtual-link <router-ID> encryption ipsec spi
<256-4294967295> esp {aes-cbc <AES-CBC-key>|3des
<3DES-key>|null}{md5 <MD5-key>|sha1 <SHA1-key>}
no area <area-id> encryption ipsec spi <256-4294967295>
```

Parameter	Description				
<area-id>	The OSPF area that you are specifying the summary route default- cost for. This can be entered in either dotted decimal format or normal decimal format. Use one of the following formats: <table border="1" data-bbox="730 1025 1423 1279"> <tr> <td><ip-addr></td> <td>OSPF area-ID expressed in IPv4 address format A.B.C.D.</td> </tr> <tr> <td><0-4294967295></td> <td>OSPF area-ID expressed as a decimal number within the range shown.</td> </tr> </table> For example, the values 0.0.1.2 and decimal 258 would both define the same area-ID.	<ip-addr>	OSPF area-ID expressed in IPv4 address format A.B.C.D.	<0-4294967295>	OSPF area-ID expressed as a decimal number within the range shown.
<ip-addr>	OSPF area-ID expressed in IPv4 address format A.B.C.D.				
<0-4294967295>	OSPF area-ID expressed as a decimal number within the range shown.				
virtual-link	Specify a virtual link and its parameters.				
<router-ID>	Enter a router ID associated with a virtual link neighbor in IPv4 address format A.B.C.D.				
encryption	Specify this keyword to enable encryption.				
ipsec	Specify this keyword to use IPsec authentication.				
spi	Specify this keyword to set the SPI (Security Parameters Index).				
<256-4294967295>	Specify an SPI (Security Parameters Index) value in the range 256 to 4294967295, entered as a decimal integer.				
esp	Specify the esp keyword (Encapsulating Security Payload) to then apply either AES-CBC or 3DES encryption.				
aes-cbc	Specify this keyword to enable AES-CBC (Advanced Encryption Standard-Cipher Block Chaining) encryption.				
<AES-CBC-key>	Enter an AES-CBC key containing either 32, 48, or 64 hexadecimal characters.				
3des	Specify 3DES (Triple Data Encryption Standard) encryption.				
<3DES-key>	Enter a 3DES key containing 48 hexadecimal characters.				

Parameter	Description
null	Specify ESP without AES-CBC or 3DES encryption applied.
md5	Specify the MD5 (Message-Digest 5) encryption algorithm.
<MD5-key>	Enter an MD5 key containing 32 hexadecimal characters.
sha1	Specify the SHA-1 (Secure Hash Algorithm 1) encryption algorithm.
<SHA1-key>	Enter an SHA-1 key containing 40 hexadecimal characters.

Mode Router Configuration

Usage notes When you issue this command, authentication and encryption are both enabled.

Use this command on an OSPFv3 area virtual link, use the [area encryption ipsec spi esp](#) command on an OSPFv3 area. Configure the same SPI (Security Parameters Index) value on all interfaces that connect to the same link. SPI values are used by link interfaces. Use a different SPI value for a different link interface when using OSPFv3 with link interfaces.

Security is achieved using the IPv6 ESP extension header. ESP is used to provide confidentiality, integrity, authentication, and confidentiality. Authentication fields are removed from OSPF for IPv6 packet headers. The IPv6 ESP extension header is required for integrity, authentication, and confidentiality.

Note that interface configuration takes priority over area configuration. If an interface configuration is removed then an area configuration is applied to an interface instead.

Use the **sha1** keyword to choose SHA-1 authentication instead of entering the **md5** keyword to use MD5 authentication. The SHA-1 algorithm is more secure than the MD5 algorithm. SHA-1 uses a 40 hexadecimal character key instead of a 32 hexadecimal character key as used for MD5 authentication.

See the [OSPFv3 Feature Overview and Configuration Guide](#) for more information and examples.

Example To enable ESP encryption, but not apply an AES-CBC key or a 3DES key, and MD5 authentication with a 32 hexadecimal character key for virtual links in OPSPF area 1, use the commands:

```
awplus# configure terminal
awplus(config)# router ipv6 ospf
awplus(config-router)# area 1 virtual-link 10.0.0.1 encryption
ipsec spi 1000 esp null md5 1234567890ABCDEF1234567890ABCDEF
```

To enable ESP encryption, but not apply an AES-CBC key or a 3DES key, and SHA-1 authentication with a 40 hexadecimal character key for virtual links in OSPF area 1, use the commands:

```
awplus# configure terminal
awplus(config)# router ipv6 ospf
awplus(config-router)# area 1 virtual-link 10.0.0.1 encryption
ipsec spi 1000 esp null sha1
1234567890ABCDEF1234567890ABCDEF12345678
```

To enable ESP encryption with a 32 hexadecimal character AES-CBC key and a 40 hexadecimal character SHA-1 authentication key for virtual links in OSPF area 1, use the commands:

```
awplus# configure terminal
awplus(config)# router ipv6 ospf
awplus(config-router)# area 1 virtual-link 10.0.0.1 encryption
ipsec spi 1000 esp aes-cbc 1234567890ABCDEF1234567890ABCDEF
sha1 1234567890ABCDEF1234567890ABCDEF12345678
```

To enable ESP encryption with a 48 hexadecimal character 3DES key and a 40 hexadecimal character SHA-1 authentication key for virtual links in OSPF area 1, use the commands:

```
awplus# configure terminal
awplus(config)# router ipv6 ospf
awplus(config-router)# area 1 virtual-link 10.0.0.1 encryption
ipsec spi 1000 esp 3des
1234567890ABCDEF1234567890ABCDEF1234567890ABCDEF sha1
1234567890ABCDEF1234567890ABCDEF12345678
```

To disable authentication for virtual links in OSPF area 1, use the commands:

```
awplus# configure terminal
awplus(config)# router ipv6 ospf
awplus(config-router)# no area 1 virtual-link 10.0.0.1
authentication ipsec spi 1000
```

**Related
commands**

[area authentication ipsec spi](#)
[area encryption ipsec spi esp](#)
[area virtual-link authentication ipsec spi](#)
[show ipv6 ospf virtual-links](#)

auto-cost reference bandwidth (IPv6 OSPF)

Overview This command controls how OSPF calculates default metrics for the interface. Use the **no** variant of this command to assign cost based only on the interface bandwidth.

Syntax `auto-cost reference-bandwidth <1-4294967>`
`no auto-cost reference-bandwidth`

Parameter	Description
<code><1-4294967></code>	The reference bandwidth, measured in Mbits per second (Mbps).

Default 1000 Mbps

Usage notes By default, OSPF calculates the OSPF metric for an interface by dividing the reference bandwidth by the interface bandwidth. The default for the reference bandwidth is 1000 Mbps. As a result, if this default is used, there is very little difference between the metrics applied to interfaces of increasing bandwidth beyond 1000 Mbps.

The auto-cost command is used to alter this reference bandwidth in order to give a real difference between the metrics of high bandwidth links of differing bandwidths. In a network that has multiple links with high bandwidths, specify a larger reference bandwidth value to differentiate the costs on those links.

Cost is calculated by dividing the reference bandwidth (Mbps) by the layer 3 interface (Switched Virtual Interface (SVI), Loopback or Ethernet interface) bandwidth. Interface bandwidth may be altered by using the [bandwidth](#) command as the SVI does not auto-detect the bandwidth based on the speed of associated device ports.

When the reference bandwidth calculation results in a cost integer greater than 1 but contains a fractional value (the value after the decimal point), the result rounds down to the nearest integer. The following example shows how the cost is calculated.

The reference bandwidth is 1000 Mbps and the interface bandwidth is 7 Mbps.

Calculation = $1000/7$

Calculation result = 142.85 (integer of 142, fractional value of 0.85)

Result after rounding down to the nearest integer = 142 (Interface cost is 142)

When the reference bandwidth calculation results in a cost less than 1, it is rounded up to the nearest integer which is 1. The following example shows how the cost is calculated.

The reference bandwidth is 1000 Mbps and the interface bandwidth is 10000 Mbps.

Calculation = $1000/10000$

Calculation result = 0.1

Result after rounding up to the nearest integer = 1 (Interface cost is 1)

The auto-cost reference bandwidth value should be consistent across all OSPF routers in the OSPF process.

Note that using the `ipv6 ospf cost` command on a layer 3 interface will override the cost calculated by this command.

Mode Router Configuration

Example

```
awplus# configure terminal
awplus(config)# router ipv6 ospf 20
awplus(config-router)# auto-cost reference-bandwidth 1000
```

Related commands [ipv6 ospf cost](#)

bandwidth

Overview Use this command to specify the maximum bandwidth to be used for each interface. The bandwidth value is in bits per second. OSPF uses this to calculate metrics for the interface.

The **no** variant of this command removes any applied bandwidth value.

Syntax `bandwidth <bandwidth-setting>`
`no bandwidth`

Parameter	Description
<code><bandwidth-setting></code>	Sets the bandwidth for the interface. Enter a value in the range 1 to 10000000000 bits per second. Note that to avoid entering many zeros, you can add k, m, or g to internally add 3, 6 or 9 zeros to the number entered. For example entering 1k is the same as entering 1000.

Mode Interface Configuration for a VLAN interface, an Eth interface, an 802.1Q sub-interface, a PPP interface, a bridge, or a tunnel.

Example To set the bandwidth on VLAN2 to be 10 Mbps, use the following commands:

```
awplus# configure terminal
awplus(config)# interface vlan2
awplus(config-if)# bandwidth 10000000
or
awplus(config-if)# bandwidth 10m
```

Related commands [show interface](#)

clear ipv6 ospf process

Overview This command clears and restarts the IPv6 OSPF routing process. Specify the Process ID to clear one particular OSPF process. When no Process ID is specified, this command clears all running OSPF processes.

Syntax `clear ipv6 ospf [<0-65535>] process`

Parameter	Description
<0-65535>	The routing process ID.

Mode Privileged Exec

Example `awplus# clear ipv6 ospf process`

debug ipv6 ospf events

Overview This command enables IPv6 OSPF debugging for event troubleshooting.

To enable all debugging options, specify **debug ipv6 ospf event** with no additional parameters.

The **no** and **undebug** variants of this command disable OSPF debugging. Using this command with no parameters entered, will disable debugging for all parameter options.

Syntax `debug ipv6 ospf events [abr] [asbr] [os][router] [vlink]`
`no debug ipv6 ospf events [abr] [asbr] [os] [router] [vlink]`

Parameter	Description
abr	Shows ABR events.
asbr	Shows ASBR events.
router	Shows other router events.
os	Shows OS events.
vlink	Shows virtual link events.

Mode Privileged Exec and Global Configuration

Example To enable IPv6 event debugging and show ABR events, use the following command:

```
awplus# debug ipv6 ospf events asbr
```

debug ipv6 ospf ifsm

- Overview** This command specifies debugging options for IPv6 OSPF Interface Finite State Machine (IFSM) troubleshooting.
- To enable all debugging options, specify **debug ipv6 ospf ifsm** with no additional parameters.
- The **no** and **undebug** variants of this command disable IPv6 OSPF IFSM debugging. Use these commands without parameters to disable all the options.

- Syntax** `debug ipv6 ospf ifsm [events] [status] [timers]`
`no debug ipv6 ospf ifsm [events] [status] [timers]`

Parameter	Description
events	Displays IFSM event information.
status	Displays IFSM status information.
timers	Displays IFSM timer information.

- Mode** Privileged Exec and Global Configuration

- Example** To specify IPv6 OSPF debugging options to display IPv6 OSPF IFSM events information, use the following commands:

```
awplus# debug ipv6 ospf ifsm events
```

- Related commands** [terminal monitor](#)
[undebug ipv6 ospf ifsm](#)

debug ipv6 ospf lsa

Overview This command enables debugging options for IPv6 OSPF Link State Advertisements (LSA) troubleshooting. This displays information related to internal operations of LSAs.

To enable all debugging options, specify **debug ipv6 ospf lsa** with no additional parameters.

The **no** and **undebug** variants of this command disable IPv6 OSPF LSA debugging. Use this command without parameters to disable all the options.

Syntax

```
debug ipv6 ospf lsa [flooding] [generate] [install] [maxage] [refresh]
no debug ipv6 ospf lsa [flooding] [generate] [install] [maxage] [refresh]
```

Parameter	Description
flooding	Displays LSA flooding.
generate	Displays LSA generation.
install	Show LSA installation.
maxage	Shows maximum age of the LSA in seconds.
refresh	Displays LSA refresh.

Mode Privileged Exec and Global Configuration

Examples To enable debugging for IPv6 OSPF refresh LSA, use the following commands:

```
awplus# debug ipv6 ospf lsa refresh
```

Related commands [terminal monitor](#)
[undebug ipv6 ospf lsa](#)

debug ipv6 ospf nfsm

Overview This command enables debugging options for IPv6 OSPF Neighbor Finite State Machines (NFSMs).

To enable all debugging options, specify **debug ipv6 ospf nfsm** with no additional parameters.

The **no** and **undebug** variants of this command disable IPv6 OSPF NFSM debugging. Use this command without parameters to disable all the options.

Syntax `debug ipv6 ospf nfsm [events] [status] [timers]`
`no debug ipv6 ospf nfsm [events] [status] [timers]`

Parameter	Description
events	Displays NFSM event information.
status	Displays NFSM status information.
timers	Displays NFSM timer information.

Mode Privileged Exec and Global Configuration

Examples To enable IPv6 debugging option to display timer information, use the following command:

```
awplus# debug ipv6 ospf nfsm timers
```

Related commands [terminal monitor](#)
[undebug ipv6 ospf nfsm](#)

debug ipv6 ospf packet

Overview This command enables debugging options for IPv6 OSPF packets.

To enable all debugging options, specify **debug ipv6 ospf packet** with no additional parameters.

The **no** and **undebug** variants of this command disable IPv6 OSPF packet debugging. Use this command without parameters to disable all options.

Syntax

```
debug ipv6 ospf packet [dd] [detail] [hello] [ls-ack]
[ls-request] [ls-update] [recv] [send]
no debug ipv6 ospf packet [dd] [detail] [hello] [ls-ack]
[ls-request] [ls-update] [recv] [send]
```

Parameter	Description
dd	Specifies debugging for IPv6 OSPF database descriptions.
detail	Sets the debug option to detailed information.
hello	Specifies debugging for IPv6 OSPF hello packets.
ls-ack	Specifies debugging for IPv6 OSPF link state acknowledgments.
ls-request	Specifies debugging for IPv6 OSPF link state requests.
ls-update	Specifies debugging for IPv6 OSPF link state updates.
recv	Specifies the debug option set for received packets.
send	Specifies the debug option set for sent packets.

Mode Privileged Exec and Global Configuration

Examples To enable debugging for hello packets, use the following command:

```
awplus# debug ipv6 ospf packet hello
```

Related commands [terminal monitor](#)
[undebug ipv6 ospf packet](#)

debug ipv6 ospf route

Overview This command enables debugging of route calculation. Use this command without parameters to turn on all the options.

The **no** and **undebug** variants of this command disable IPv6 OSPF route debugging. Use this command without parameters to disable all options.

Syntax debug ipv6 ospf route [ase] [ia] [install] [spf]
no debug ipv6 ospf route [ase] [ia] [install] [spf]

Parameter	Description
ase	Specifies the debugging of external route calculation.
ia	Specifies the debugging of inter-area route calculation.
install	Specifies the debugging of route installation.
spf	Specifies the debugging of SPF calculation.

Mode Privileged Exec and Global Configuration

Examples To enable IPv6 route debugging of inter-area route calculations, use the following command:

```
awplus# debug ipv6 ospf route ia
```

Related commands [terminal monitor](#)
[undebug ipv6 ospf route](#)

default-information originate

Overview This command creates a default external route into an OSPF routing domain.

When you use the **default-information originate** command to redistribute routes into an OSPF routing domain, then the system acts like an Autonomous System Boundary Router (ASBR). By default, an ASBR does not generate a default route into the OSPF routing domain.

When using this command, also specify the **route-map <route-map>** option to avoid a dependency on the default network in the routing table.

The **metric-type** is an external link type associated with the default route advertised into the OSPF routing domain. The value of the external route could be either Type 1 or 2. The default is Type 2.

The **no** variant of this command disables this feature.

Syntax

```
default-information originate [always] [metric <metric>]
[metric-type <1-2>] [route-map <route-map>]

no default-information originate [always] [metric]
[metric-type] [route-map]
```

Parameter	Description
always	Used to advertise the default route regardless of whether there is a default route.
<metric>	The metric value used in creating the default route. Enter a value in the range 0 to 16777214. The default metric value is 10. The value used is specific to the protocol.
<1-2>	External metric type for default routes, either OSPF External Type 1 or Type 2 metrics. Enter the value 1 or 2.
route-map	Specifies to use a specific route-map.
<route-map>	The route-map name. It is a string comprised of any characters, numbers or symbols.

Mode Router Configuration

Example

```
awplus# configure terminal
awplus(config)# router ospf 100
awplus(config-router)# default-information originate always
metric 23 metric-type 2 route-map myinfo
```

Related commands [route-map](#)

default-metric (IPv6 OSPF)

Overview This command sets default metric value for routes redistributed into the IPv6 OSPF routing protocol.

The **no** variant of this command returns IPv6 OSPF to using built-in, automatic metric translations, as appropriate for each routing protocol.

Syntax `default-metric <0-16777214>`
`no default-metric [<0-16777214>]`

Parameter	Description
<code><1-16777214></code>	Default metric value appropriate for the specified routing protocol.

Mode Router Configuration

Usage notes A default metric facilitates redistributing routes even with incompatible metrics. If the metrics do not convert, the default metric provides an alternative and enables the redistribution to continue. The effect of this command is that IPv6 OSPF will use the same metric value for **all** redistributed routes. Use this command in conjunction with the [redistribute \(IPv6 OSPF\)](#) command.

Examples

```
awplus# configure terminal
awplus(config)# router ipv6 ospf 100
awplus(config-router)# default-metric 100
awplus# configure terminal
awplus(config)# router ipv6 ospf 100
awplus(config-router)# no default-metric
```

Related commands [redistribute \(IPv6 OSPF\)](#)

distance (IPv6 OSPF)

Overview This command sets the administrative distance for OSPFv3 routes based on the route type. Your device uses this value to select between two or more routes to the same destination from two different routing protocols. The route with the smallest administrative distance value is added to the Forwarding Information Base (FIB). See the [OSPFv3 Feature Overview and Configuration Guide](#) for more information.

Use the command **distance ospfv3** to set the distance for an entire category of OSPFv3 routes, rather than the specific routes that pass an access list.

Use the command **distance <1-254>**, with no other parameter, to set the same distance for all OSPFv3 route types.

The **no** variant of this command sets the administrative distance for OSPFv3 routes to the default of 110.

Syntax `distance <1-254>`
`distance ospfv3 {external <1-254>|inter-area <1-254>|intra-area <1-254>}`
`no distance {ospfv3|<1-254>}`

Parameter	Description
<1-254>	Specify the Administrative Distance value for OSPFv3 routes.
external	Sets the distance for routes from other routing domains, learned by redistribution. Specify an OSPFv3 external distance in the range <1-254>.
inter-area	Sets the distance for all routes from one area to another area. Specify an OSPFv3 inter-area distance in the range <1-254>.
intra-area	Sets the distance for all routes within an area. Specify an OSPFv3 intra-area distance in the range <1-254>.

Default The default OSPFv3 administrative distance is 110. The default Administrative Distance for each type of route (intra, inter, or external) is 110.

Mode Router Configuration

Usage notes The administrative distance rates the trustworthiness of a routing information source. The distance could be any integer from 0 to 254. A higher distance value indicates a lower trust rating. For example, an administrative distance of 254 indicates that the routing information source cannot be trusted and should be ignored.

Use this command to set the distance for an entire group of routes, rather than a specific route that passes an access list.

Examples To set the following administrative distances for route types in OSPF 100:

- 20 for inter-area routes

- 10 for intra-area routes
- 40 for external routes

use the commands:

```
awplus(config)# router ipv6 ospf 100  
awplus(config-router)# distance ospfv3 inter-area 20 intra-area  
10 external 40
```

To set the administrative distance for all routes in OSPFv3 100 back to the default of 110, use the commands:

```
awplus(config)# router ipv6 ospf 100  
awplus(config-router)# no distance ospfv3
```

ipv6 ospf authentication spi

Overview Use this command in Interface Configuration mode to enable either MD5 (Message-Digest 5) or SHA1 (Secure Hash Algorithm 1) authentication for a specified interface.

Use the **no** variant of this command in Interface Configuration mode to disable the authentication configured for a specified interface.

Syntax `ipv6 ospf authentication ipsec spi <256-4294967295> {md5 <MD5-key>|sha1 <SHA1-key>}`
`ipv6 ospf authentication null`
`no ipv6 ospf authentication ipsec spi <256-4294967295>`

Parameter	Description
authentication	Specify this keyword to enable authentication.
ipsec	Specify this keyword to use IPsec authentication.
spi	Specify this keyword to set the SPI (Security Parameters Index).
<256-4294967295>	Specify an SPI (Security Parameters Index) value in the range 256 to 4294967295, entered as a decimal integer.
md5	Specify the MD5 (Message-Digest 5) hashing algorithm.
<MD5-key>	Enter an MD5 key containing up to 32 hexadecimal characters.
sha1	Specify the SHA-1 (Secure Hash Algorithm 1) hashing algorithm.
<SHA1-key>	Enter an SHA-1 key containing up to 40 hexadecimal characters.
null	Specify no authentication is applied when no other parameters are applied after this keyword (<code>ipv6 ospf authentication null</code>). Note this overrides any existing area authentication configured.

Default Authentication is not configured on an interface by default.

Mode Interface Configuration for a VLAN interface, an Eth interface, an 802.1Q sub-interface, a PPP interface, a bridge, or a tunnel.

Usage notes Configure the same SPI (Security Parameters Index) value on all interfaces that connect to the same link. SPI values are used by link interfaces. Use a different SPI value for a different link interface when using OSPFv3 with link interfaces.

Use the **sha1** keyword to choose SHA-1 authentication instead of entering the **md5** keyword to use MD5 authentication. The SHA-1 algorithm is more secure than the MD5 algorithm. SHA-1 uses a 40 hexadecimal character key instead of a 32 hexadecimal character key as used for MD5 authentication.

Use the **null** keyword to override existing area authentication. Apply the **null** keyword if area authentication is already configured to configure authentication on an interface.

See the [OSPFv3 Feature Overview and Configuration Guide](#) for more information and examples.

NOTE: You can configure an authentication security policy (SPI) on an interface with this command, or an OSPFv3 area with the [area authentication ipsec spi](#) command.

When you configure authentication for an area, the security policy is applied to all interfaces in the area. Allied Telesis recommends a different authentication security policy is applied to each interface for higher security.

If you apply the **ipv6 ospf authentication null** command, this affects authentication configured on both the interface and the OSPFv3 area.

This is due to OSPFv3 hello messages ingressing interfaces, which are part of area authentication, not being authenticated. So neighbors time out.

Example To enable SHA-1 authentication with a 40 hexadecimal character key for interface eth1, use the commands:

```
awplus# configure terminal
awplus(config)# interface eth1
awplus(config-if)# ipv6 ospf authentication ipsec spi 1000 sha1
1234567890ABCDEF1234567890ABCDEF12345678
```

To specify no authentication is applied to interface eth1, use the commands:

```
awplus# configure terminal
awplus(config)# interface eth1
awplus(config-if)# ipv6 ospf authentication null
```

To disable authentication for interface eth1, use the commands:

```
awplus# configure terminal
awplus(config)# interface eth1
awplus(config-if)# no ipv6 ospf authentication ipsec spi 1000
```

Related commands

- [area authentication ipsec spi](#)
- [area encryption ipsec spi esp](#)
- [ipv6 ospf encryption spi esp](#)
- [show ipv6 ospf interface](#)

ipv6 ospf cost

Overview This command explicitly specifies the cost of the link-state metric in a router-LSA. The interface cost indicates the overhead required to send packets across a certain interface. Use this command to set the interface cost manually. The **no** variant of this command resets the interface cost to the default.

Syntax `ipv6 ospf cost <1-65535>`
`no ipv6 ospf cost`

Parameter	Description
<1-65535>	The link-state metric.

Default By default there is no static value set and the OSPF cost is automatically calculated by using the command [auto-cost reference bandwidth \(IPv6 OSPF\)](#).

Mode Interface Configuration for a VLAN interface, an Eth interface, an 802.1Q sub-interface, a PPP interface, a bridge, or a tunnel.

Usage notes This command explicitly sets a user specified cost of sending packets out the interface. Using this command overrides the cost value calculated automatically with the auto-cost reference bandwidth (IPv6 OSPF) feature.

The link-state metric cost is stated in the Router-LSA's link. Typically, the cost is inversely proportional to the bandwidth of an interface. By default, the cost of an interface is calculated according to the following formula:

reference bandwidth / interface bandwidth

The reference bandwidth is set by default at 1000000 kbps (or 1000 Mbps), but can be changed by the command [auto-cost reference bandwidth \(IPv6 OSPF\)](#).

The interface bandwidth is set by default to 1000000 kbps (or 1000 Mbps), but can be changed by the [bandwidth](#) command.

Example To set the IPv6 OSPF cost to 10 on the interface ppp0, use the following commands:

```
awplus# configure terminal
awplus(config)# interface ppp0
awplus(config-if)# ipv6 ospf cost 10
```

Related commands [show ipv6 ospf interface](#)
[auto-cost reference bandwidth \(IPv6 OSPF\)](#)
[bandwidth](#)

ipv6 ospf dead-interval

Overview This command sets the interval during which no hello packets are received and after which a neighbor is declared dead.

The dead-interval is the amount of time that OSPF waits to receive an OSPF hello packet from the neighbor before declaring the neighbor is down. This value is advertised in the router's hello packets. It must be a multiple of the hello-interval and be the same for all routers on a specific network.

The **no** variant of this command returns the interval to the default of 40 seconds.

Syntax `ipv6 ospf dead-interval <1-65535> [<inst-id>]`
`no ipv6 ospf dead-interval`

Parameter	Description
<1-65535>	The interval in seconds. Default: 40
<inst-id>	The instance ID Default: 0

Mode Interface Configuration for a VLAN interface, an Eth interface, an 802.1Q sub-interface, a PPP interface, a bridge, or a tunnel.

Default 40 seconds.

Example The following example shows configuring the dead-interval to 10 seconds on the interface eth1:

```
awplus# configure terminal
awplus(config)# interface eth1
awplus(config-if)# ipv6 ospf dead-interval 10
```

Related commands [ipv6 ospf hello-interval](#)
[show ipv6 ospf interface](#)

ipv6 ospf display route single-line

Overview Use this command to change the result of the **show ipv6 route** command to display each route entry on a single line.

Syntax `ipv6 ospf display route single-line`
`no ipv6 ospf display route single-line`

Mode Global Configuration

Example To display each route entry on a single line.

```
awplus# configure terminal  
awplus(config)# ipv6 ospf display route single-line
```

Related commands [show ipv6 ospf route](#)

ipv6 ospf encryption spi esp

Overview Use this command in Interface Configuration mode to enable either AES-CBC (Advanced Encryption Standard-Cipher Block Chaining) or 3DES (Triple Data Encryption Standard) ESP (Encapsulating Security Payload) encryption for a specified interface.

Use the **no** variant of this command in Interface Configuration mode to disable the encryption configured for a specified interface.

Syntax

```
ipv6 ospf encryption ipsec spi <256-4294967295> esp {aes-cbc  
<AES-CBC-key>|3des <3DES-key>|null} {md5 <MD5-key>|sha1  
<SHA1-key>}  
  
ipv6 ospf encryption null  
  
no ipv6 ospf encryption ipsec spi <256-4294967295>
```

Parameter	Description
<256-4294967295>	Specify an SPI (Security Parameters Index) value in the range 256 to 4294967295, entered as a decimal integer.
esp	Specify the esp keyword (Encapsulating Security Payload) to then apply either AES-CBC or 3DES encryption.
aes-cbc	Specify this keyword to enable AES-CBC (Advanced Encryption Standard-Cipher Block Chaining) encryption.
<AES-CBC-key>	Enter an AES-CBC key containing either 32, 48, or 64 hexadecimal characters.
3des	Specify 3DES (Triple Data Encryption Standard) encryption.
<3DES-key>	Enter a 3DES key containing 48 hexadecimal characters.
null	Specify ESP without AES-CBC or 3DES encryption applied.
md5	Specify the MD5 (Message-Digest 5) encryption algorithm.
<MD5-key>	Enter an MD5 key containing 32 hexadecimal characters.
sha1	Specify the SHA-1 (Secure Hash Algorithm 1) encryption algorithm.
<SHA1-key>	Enter an SHA-1 key containing 40 hexadecimal characters.
null	Specify no encryption is applied when no other parameters are applied after this keyword (<code>ipv6 ospf encryption null</code>).

Default Authentication is not configured on an interface by default.

Mode Interface Configuration for a VLAN interface, an Eth interface, an 802.1Q sub-interface, a PPP interface, a bridge, or a tunnel.

Usage notes When you issue this command, authentication and encryption are both enabled. Configure the same SPI (Security Parameters Index) value on all interfaces that

connect to the same link. SPI values are used by link interfaces. Use a different SPI value for a different link interface when using OSPFv3 with link interfaces.

Security is achieved using the IPv6 ESP extension header. The IPv6 ESP extension header is used to provide confidentiality, integrity, authentication, and confidentiality. Authentication fields are removed from OSPF for IPv6 packet headers, so applying IPv6 ESP extension headers are required for integrity, authentication, and confidentiality.

Use the **null** keyword to override existing area encryption. Apply the **null** keyword if area encryption is already configured to then configure encryption on an interface instead.

Use the **sha1** keyword to choose SHA-1 authentication instead of entering the **md5** keyword to use MD5 authentication. The SHA-1 algorithm is more secure than the MD5 algorithm. SHA-1 uses a 40 hexadecimal character key instead of a 32 hexadecimal character key as used for MD5 authentication.

See the [OSPFv3 Feature Overview and Configuration Guide](#) for more information and examples.

NOTE: You can configure an encryption security policy (SPI) on an interface with this command, or an OSPFv3 area with the [area encryption ipsec spi esp](#) command.

When you configure encryption for an area, the security policy is applied to all interfaces in the area. Allied Telesis recommends a different encryption security policy is applied for each interface for higher security.

If you apply the **ipv6 ospf encryption null** command this affects encryption configured on both the interface and the OSPFv3 area.

This is due to OSPFv3 hello messages ingressing interfaces, which are part of area encryption, not being encrypted. So neighbors time out.

Example To enable ESP encryption but not apply an AES-CBC key or a 3DES key, for interface eth1 and SHA-1 authentication with a 40 hexadecimal character key, use the commands:

```
awplus# configure terminal
awplus(config)# interface eth1
awplus(config-if)# ipv6 ospf encryption ipsec spi 1000 esp null
sha1 1234567890ABCDEF1234567890ABCDEF12345678
```

To enable ESP encryption with an AES-CBC key with a 32 hexadecimal character key and SHA-1 authentication with a 40 hexadecimal character key for interface eth1, use the commands:

```
awplus# configure terminal
awplus(config)# interface eth1
awplus(config-if)# ipv6 ospf encryption ipsec spi 1000 esp
aes-cbc 1234567890ABCDEF1234567890ABCDEF sha1
1234567890ABCDEF1234567890ABCDEF12345678
```

To specify no ESP encryption is applied to interface eth1, use the commands:

```
awplus# configure terminal
awplus(config)# interface eth1
awplus(config-if)# ipv6 ospf encryption null
```

To disable ESP encryption for interface eth1, use the commands:

```
awplus# configure terminal
awplus(config)# interface eth1
awplus(config-if)# no ipv6 ospf encryption ipsec spi 1000
```

**Related
commands**

[area authentication ipsec spi](#)
[area encryption ipsec spi esp](#)
[ipv6 ospf authentication spi](#)
[show ipv6 ospf interface](#)

ipv6 ospf hello-interval

- Overview** This command specifies the interval between hello packets.
- The hello-interval is advertised in the hello packets. Configure the same hello-interval for all routers on a specific network. A shorter interval ensures faster detection of topological changes, but results in more routing traffic.
- The **no** variant of this command returns the interval to the default of 10 seconds.

Syntax `ipv6 ospf hello-interval <1-65535>`
`no ipv6 ospf hello-interval`

Parameter	Description
<code><1-65535></code>	The hello-interval in seconds. Default: 10

- Default** The default interval is 10 seconds.
- Mode** Interface Configuration for a VLAN interface, an Eth interface, an 802.1Q sub-interface, a PPP interface, a bridge, or a tunnel.
- Example** The following example shows setting the hello-interval to 3 seconds on the interface eth1:

```
awplus# configure terminal
awplus(config)# interface eth1
awplus(config-if)# ipv6 ospf hello-interval 3
```

Related commands [ipv6 ospf dead-interval](#)
[show ipv6 ospf interface](#)

ipv6 ospf neighbor

Overview Use this command to configure static OSPFv3 IPv6 neighbors when using the OSPFv3 "non-broadcast" (NBMA) and "point-to-multipoint non-broadcast" (P2MP NBMA) network types. OSPFv3 messages exchanged between the neighbors are unicast only.

Use the **no** variant of this command to remove a configuration.

Syntax `ipv6 ospf neighbor <ipv6-address>`
`[<cost>|<instance-id>|<poll-interval>|<priority>]`
`no ipv6 ospf neighbor <ipv6-address>`
`[<cost>|<instance-id>|<poll-interval>|<priority>]`

Parameter	Description
<code><ipv6-address></code>	Specifies the interface IPv6 address of the neighbor.
<code><cost></code>	<code>cost <1-65535></code> OSPF cost for point-to-multipoint neighbor.
<code><instance-id></code>	<code>instance-id <0-255></code> Interface instance ID.
<code><poll-interval></code>	<code>poll-interval <0-4294967295></code> Dead neighbor polling interval in seconds. It is recommended to set this value much higher than the hello interval. The default is 120 seconds.
<code><priority></code>	<code>priority <0-255></code> Specifies the router priority value of the non-broadcast neighbor associated with the specified IP address. The default is 0. This keyword does not apply to point-to-multipoint interfaces.

Mode Interface Configuration for a VLAN interface, an Eth interface, an 802.1Q sub-interface, a PPP interface, a bridge, or a tunnel.

Usage notes To configure a neighbor on an NBMA network manually, use the **ipv6 ospf neighbor** command and include one neighbor entry for each known non-broadcast network neighbor. The IPv6 address used in this command is the neighbor's primary IPv6 address on the interface where that neighbor connects to the NBMA network.

The poll interval is the reduced rate at which routers continue to send hello packets, when a neighboring router has become inactive. Set the poll interval to be much larger than the hello interval.

Examples To configure a neighbor with a priority value, poll interval time, and cost, use the commands:

```
awplus# configure terminal
awplus(config)# interface eth1
awplus(config-if)# ipv6 ospf neighbor fe80::c:20:0:1 priority 1
poll-interval 90
awplus(config-router)# ipv6 ospf neighbor fe80::c:20:0:1 cost
15
```

Related commands [show ipv6 ospf neighbor](#)

ipv6 ospf network

Overview This command configures the OSPF network type to a type different from the default for the particular interface.

The **no** variant of this command returns the network type to the default for the particular interface.

Syntax `ipv6 ospf network {broadcast|non-broadcast|point-to-point|point-to-multipoint}`
`no ipv6 ospf network`

Parameter	Description
<code>broadcast</code>	Sets the network type to broadcast.
<code>non-broadcast</code>	Sets the network type to NBMA.
<code>point-to-multipoint</code>	Sets the network type to point-to-multipoint.
<code>point-to-point</code>	Sets the network type to point-to-point.

Default The default is the default type for the interface, e.g broadcast for VLANs.

Mode Interface Configuration for a VLAN interface, an Eth interface, an 802.1Q sub-interface, a PPP interface, a bridge, or a tunnel.

Usage notes This command forces the interface network type to be the specified type. Depending on the network type, OSPF changes the behavior of the packet transmission and the link description in LSAs.

Example The following example shows setting the network type to point-to-point on the interface eth1:

```
awplus# configure terminal
awplus(config)# interface eth1
awplus(config-if)# ipv6 ospf network point-to-point
```

ipv6 ospf priority

Overview This command sets the router priority, which is a parameter used in the election of the designated router for the link.

The **no** variant of this command returns the router priority to the default of 1.

Syntax `ipv6 ospf priority <priority>`
`no ipv6 ospf priority`

Parameter	Description
<code><priority></code>	<code><0-255></code> Specifies the router priority of the interface. The larger the value, the greater the priority level. The value 0 defines that the device cannot become either the DR, or backup DR for the link.

Default The default priority is 1.

Mode Interface Configuration for a VLAN interface, an Eth interface, an 802.1Q sub-interface, a PPP interface, a bridge, or a tunnel.

Usage Set the priority to help determine the OSPF Designated Router (DR) for a link. If two routers attempt to become the DR, the router with the higher router priority becomes the DR. If the router priority is the same for two routers, the router with the higher router ID takes precedence.

Routers with zero router priority values cannot become the designated or backup designated router.

Example The following example shows setting the OSPFv3 priority value to 3 on the interface eth1:

```
awplus# configure terminal
awplus(config)# interface eth1
awplus(config-if)# ipv6 ospf priority 3
```

ipv6 ospf retransmit-interval

Overview Use this command to specify the time between link-state advertisement (LSA) retransmissions for adjacencies belonging to the interface.

Use the **no** variant of this command to return to the default of 5 seconds.

Syntax `ipv6 ospf retransmit-interval <1-65535>`
`no ipv6 ospf retransmit-interval`

Parameter	Description
<code><1-65535></code>	Specifies the interval in seconds.

Default The default interval is 5 seconds.

Mode Interface Configuration for a VLAN interface, an Eth interface, an 802.1Q sub-interface, a PPP interface, a bridge, or a tunnel.

Usage After sending an LSA to a neighbor, the router keeps the LSA until it receives an acknowledgment. In case the router does not receive an acknowledgment during the set time (the retransmit interval value) it retransmits the LSA. Set the retransmission interval value conservatively to avoid needless retransmission. The interval should be greater than the expected round-trip delay between two routers.

Example The following example shows setting the OSPF retransmit interval to 6 seconds on the interface eth1:

```
awplus# configure terminal
awplus(config)# interface eth1
awplus(config-if)# ipv6 ospf retransmit-interval 6
```

ipv6 ospf transmit-delay

Overview Use this command to set the estimated time it takes to transmit a link-state-update packet on the interface.

Use the **no** variant of this command to return to the default of 1 second.

Syntax `ipv6 ospf transmit-delay <1-65535>`
`no ipv6 ospf transmit-delay`

Parameter	Description
<code><1-65535></code>	Specifies the time, in seconds, to transmit a link-state update.

Default The default interval is 1 second.

Mode Interface Configuration for a VLAN interface, an Eth interface, an 802.1Q sub-interface, a PPP interface, a bridge, or a tunnel.

Usage The transmit delay value adds a specified time to the age field of an update. If the delay is not added, the time in which the LSA transmits over the link is not considered. This command is especially useful for low speed links. Add transmission and propagation delays when setting the transmit delay value.

Example To set the IPv6 OSPF transmit delay time to 3 seconds on the interface eth1, use the following commands:

```
awplus# configure terminal
awplus(config)# interface eth1
awplus(config-if)# ipv6 ospf transmit-delay 3
```

ipv6 router ospf area

Overview Use this command to enable IPv6 OSPF routing on an interface.
Use the **no** variant of this command to disable IPv6 OSPF routing on an interface.

Syntax `ipv6 router ospf area <area-id> [tag <process-id>] [instance <instance-id>]`
`no ipv6 router ospf area <area-id>`

Parameter	Description
<code><area-id></code>	The ID of the IPv6 OSPF routing area. Can be entered as either an IPv4 A.B.C.D address format, or as an unsigned integer in the range, 0 to 4294967295. Use either of the following forms when entering an area-ID: <ul style="list-style-type: none"><code>area-id <A.B.C.D></code> where A.B.C.D is a number entered in IPv4 address format.<code>area-id <0 to 4294967295></code>.
<code><process-id></code>	The process tag denotes a separate router process. It can comprise any string of alphanumeric characters. Note that this tag is local to the router on which it is set and does not appear in any OSPF packets or LSA.
<code><instance-id></code>	The OSPF instance ID, entered as an integer between 0 and 255. This is the value that will appear in the instance field of the IPv6 OSPF hello packet.

Defaults IPv6 OSPF routing is disabled by default.

When enabling IPv6 OSPF routing:

- the process-tag will default to a null value if not set.
- the Instance ID defaults to 0 if not set.

Mode Interface Configuration for a VLAN interface, an Eth interface, an 802.1Q sub-interface, a PPP interface, a bridge, or a tunnel.

Usage notes When enabling IPv6 OSPF routing on an interface, specifying the area-ID is mandatory, but the Process tag and Instance are optional.

See the [OSPFv3 Feature Overview and Configuration Guide](#) for more information and examples.

Examples To enable IPv6 OSPF on interface eth1 in OSPF area 1, with a tag of 'PT2', and instance 2, use the commands:

```
awplus# configure terminal
awplus(config)# interface eth1
awplus(config-if)# ipv6 router ospf area 1 tag PT2 instance-id 2
```

To disable IPv6 OSPF on interface eth1 and OSPF area 1, use the commands:

```
awplus# configure terminal
awplus(config)# interface eth1
awplus(config-if)# no ipv6 router ospf area 1
```

max-concurrent-dd (IPv6 OSPF)

Overview Use this command to limit the number of neighbors that can be concurrently processed in the database exchange. The specified value limits the number of neighbors from all interfaces, not per interface.

Use the **no** variant of this command to have no limit on the maximum number of LSAs.

Syntax `max-concurrent-dd <max-neighbors>`
`no max-concurrent-dd`

Parameter	Description
<code><max-neighbors></code>	<code><1-65535></code> The maximum number of neighbors.

Mode Router Configuration

Usage notes This command is useful where bringing up several adjacencies on a router is affecting performance. In this situation, you can often enhance the system performance by limiting the number of neighbors that can be processed concurrently.

Example The following example sets the max-concurrent-dd value to allow only 4 neighbors to be processed at a time.

```
awplus# configure terminal
awplus(config)# router ipv6 ospf
awplus(config-router)# max-concurrent-dd 4
```

Related commands [router ipv6 ospf](#)

passive-interface (IPv6 OSPF)

Overview Use this command to suppress the sending of Hello packets on a specified interface. If you use the **passive-interface** command without the optional parameters then all interfaces are put into passive mode.

Use the **no** variant of this command to allow the sending of Hello packets on all interfaces, or on the specified interface. If you use the **no** variant of this command without the optional parameters then all interfaces are removed from passive mode.

Syntax `passive-interface [<interface>]`
`no passive-interface [<interface>]`

Parameter	Description
<interface>	The name of the interface.

Mode Router Configuration

Usage Configure an interface to be passive if you wish its connected route to be treated as an OSPF route (rather than an AS-external route), but do not wish to actually exchange any OSPF packets via this interface.

Examples To configure passive interface mode on all interfaces, enter the following commands:

```
awplus(config)# router ipv6 ospf  
awplus(config-router)# passive-interface
```

To configure passive interface mode on the local loopback interface, enter the following commands:

```
awplus(config)# router ipv6 ospf  
awplus(config-router)# passive-interface lo
```

To remove passive interface mode from all interfaces, enter the following commands:

```
awplus(config)# router ipv6 ospf  
awplus(config-router)# no passive-interface
```

redistribute (IPv6 OSPF)

Overview Use this command to redistribute routes from other routing protocols, static routes and connected routes into an IPv6 OSPF routing table.

Use the **no** variant of this command to disable this function.

Syntax `redistribute <protocol> [metric <0-16777214>] [metric-type {1|2}] [route-map <route-map-entry>]`
`no redistribute <protocol>`

Parameter	Description
<code><protocol></code>	The routing protocol to be redistributed, can be one of:
<code>connected</code>	Connected routes
<code>rip</code>	Routing Internet Protocol
<code>static</code>	Static Routes
<code>metric</code>	Specifies the external metric.
<code>metric-type</code>	Specifies the external metric-type, either type 1 or type 2. <ul style="list-style-type: none">• For Metric Type 1: The best route is based on the external redistributed path cost plus the internal path cost presented by the native routing protocol.• For Metric Type 2: The best route is based only on the external redistributed path cost. The internal path cost is only used to break a "tie" situation between two identical external path costs.
<code>route-map</code>	The name of the specific route-map.

Default The default metric value for routes redistributed into OSPFv3 is 20. The metric can also be defined using the [set metric](#) command for a route map. Note that a metric defined using the [set metric](#) command for a route map overrides a metric defined with this command.

Mode Router Configuration

Usage notes You use this command to inject routes, learned from other routing protocols, into the OSPF domain to generate AS-external-LSAs. If a route-map is configured by this command, then that route-map is used to control which routes are redistributed and can set metric and tag values on particular routes.

The metric, metric-type, and tag values specified on this command are applied to any redistributed routes that are not explicitly given a different metric, metric-type, or tag value by the route map.

See the [OSPFv3 Feature Overview and Configuration Guide](#) for more information about metrics, and about behavior when configured in route maps.

Note that this command does not redistribute the default route. To redistribute the default route, use the [default-information originate](#) command.

Example The following example shows the redistribution of RIP routes into the IPv6 OSPF routing table, with a metric of 10 and a metric type of 1.

```
awplus# configure terminal
awplus(config)# router ipv6 ospf
awplus(config-router)# redistribute rip metric 10 metric-type 1
```

restart ipv6 ospf graceful

Overview Use this command to force the OSPFv3 process to restart. You may optionally specify a grace-period value. If a grace-period is not specified then a default value of 120 seconds is applied.

You should specify a grace-period value of 120 seconds or more. Low grace-period values may cause the graceful restart process on neighboring routers to terminate with routes missing.

Syntax `restart ipv6 ospf graceful [grace-period <1-1800>]`

Parameter	Description
grace-period	Specify the grace period.
<1-1800>	The grace period in seconds.

Default The default OSPF grace-period is 120 seconds.

Mode Privileged Exec

Usage notes After this command is executed, the OSPFv3 process immediately shuts down. It notifies the system that OSPF has performed a graceful shutdown. Routes installed by OSPF are preserved until the grace-period expires.

When a **restart ospf graceful** command is issued, the OSPF configuration is reloaded from the last saved configuration. Ensure you first enter the [copy running-config startup-config](#) command.

Example To restart OSPFv3, use the following commands:

```
awplus# copy running-config startup-config  
awplus# restart ipv6 ospf graceful grace-period 200
```

To apply the default grace-period (120 seconds), use the following commands:

```
awplus# copy running-config startup-config  
awplus# restart ipv6 ospf graceful
```

router ipv6 ospf

Overview Use this command to create or remove an IPv6 OSPF routing process, or to enter the Router Configuration mode to configure a specific IPv6 OSPF routing process. Use the **no** variant of this command to terminate an IPv6 OSPF routing process.

Use the **no** parameter with the **process-id** parameter, to terminate and delete a specific IPv6 OSPF routing process.

Syntax `router ipv6 ospf [<process-id>]`
`no router ipv6 ospf [<process-id>]`

Parameter	Description
<code><process-id></code>	A character string that identifies a routing process. If you do not specify the process-id a "null" process ID will be applied. Note that this will appear in show output as *null*. However you cannot select the null process by using the character string *null* as command entry characters.

Default No routing process is defined by default.

Mode Global Configuration

Usage notes The process ID enables you to run more than one OSPF session within the same router, then configure each session to a different router port. Note that this function is internal to the router, and other routers (neighbors) have no knowledge of these different processes. The hello and LSAs issued from each process will appear as if coming from a separate physical router.

To a large extent the requirement for multiple processes has been replaced by the ability within IPv6 OSPF of running simultaneous router instances.

The process ID of IPv6 OSPF is an optional parameter for the **no** variant of this command only. When removing all IPv6 OSPF processes on the device, you do not need to specify each Process ID, but when removing particular IPv6 OSPF processes, you must specify each Process ID to be removed.

For a description of processes and instances and their configuration relationships, see the [OSPFv3 Feature Overview and Configuration Guide](#).

Example This example shows the use of this command to enter Router Configuration mode.

```
awplus# configure terminal
awplus(config)# router ipv6 ospf P100
awplus(config-router)#
```

router-id (IPv6 OSPF)

Overview Use this command to specify a router ID for the IPv6 OSPF process.
Use the **no** variant of this command to disable this function.

Syntax `router-id <router-id>`
`no router-id`

Parameter	Description
<code><router-id></code>	Specifies the router ID in IPv4 address format.

Mode Router Configuration

Usage Configure each router with a unique router-id. In an IPv6 OSPF router process that has active neighbors, a new router-id takes effect at the next reload or when you restart OSPF manually.

Example The following example shows a specified router ID 0.0.4.5.

```
awplus# configure terminal
awplus(config)# router ipv6 ospf
awplus(config-router)# router-id 0.0.4.5
```

Related commands [show ipv6 ospf](#)

show debugging ipv6 ospf

Overview Use this command to see what debugging is turned on for OSPFv3.
For information on filtering and saving command output, see the [“Getting_Started with AlliedWare Plus” Feature Overview and Configuration_Guide](#).

Syntax `show debugging ipv6 ospf`

Mode User Exec and Privileged Exec

Example `awplus# show debugging ipv6 ospf`

Output Figure 28-1: Example output from the **show debugging ipv6 ospf** command

```
OSPFv3 debugging status:
OSPFv3 all packet detail debugging is on
OSPFv3 all IFSM debugging is on
OSPFv3 all NFSM debugging is on
OSPFv3 all LSA debugging is on
OSPFv3 all NSM debugging is on
OSPFv3 all route calculation debugging is on
OSPFv3 all event debugging is on
```

show ipv6 ospf

Overview Use this command in User Exec or Privileged Exec modes to display general information about all IPv6 OSPF routing processes, including OSPFv3 Authentication configuration and status information.

Include the process ID parameter with this command to display information about specified processes.

For information on filtering and saving command output, see the [“Getting Started with AlliedWare Plus” Feature Overview and Configuration Guide](#).

Syntax `show ipv6 ospf`
`show ipv6 ospf <process-id>`

Parameter	Description
<process-id>	<0-65535> The ID of the router process for which information will be displayed. If this parameter is included, only the information for the specified routing process is displayed.

Mode User Exec and Privileged Exec

Examples To display general information about all IPv6 OSPF routing processes, use the command:

```
awplus# show ipv6 ospf
```

To display general information about IPv6 OSPF (OSPFv3) routing process P10, use the command:

```
awplus# show ipv6 ospf P10
```

Output Figure 28-2: Example output from the **show ipv6 ospf** command for process P10, showing OSPFv3 Authentication configuration information highlighted in bold

```
awplus#show ipv6 ospf
  Routing Process "OSPFv3 (10)" with ID 192.168.1.2
  Route Licence: Route : Limit=Unlimited, Allocated=0, Visible=0,
Internal=0
  Route Licence: Breach: Current=0, Watermark=0
  Process uptime is 6 minutes
  Current grace period is 120 secs (default)
  SPF schedule delay min 0.500 secs, SPF schedule delay max 50.0
secs
  Minimum LSA interval 5 secs, Minimum LSA arrival 1 secs
  Number of incoming current DD exchange neighbors 0/5
  Number of outgoing current DD exchange neighbors 0/5
  Number of external LSA 0. Checksum Sum 0x0000
  Number of AS-Scoped Unknown LSA 0
  Number of LSA originated 4
  Number of LSA received 10
  Number of areas in this router is 1
    Area BACKBONE(0)
      Number of interfaces in this area is 1(1)
      MD5 Authentication SPI 1000
      NULL Encryption SHA-1 Auth, SPI 1001
      SPF algorithm executed 9 times
      Number of LSA 3. Checksum Sum 0xF9CC
      Number of Unknown LSA 0
```

Related commands

- [area authentication ipsec spi](#)
- [area encryption ipsec spi esp](#)
- [router ipv6 ospf](#)

show ipv6 ospf database

Overview Use this command in User Exec or Privileged Exec modes to display a database summary for IPv6 OSPF information. Include the process ID parameter with this command to display information about specified processes.

For information on filtering and saving command output, see the [“Getting Started with AlliedWare Plus” Feature Overview and Configuration Guide](#).

Syntax `show ipv6 ospf <process-id> database
[self-originate|max-age|adv router <adv-router-id>]`

Parameter	Description
<process-id>	<0-65535> The ID of the router process for which information will be displayed.
self-originate	Displays self-originated link states.
max-age	Displays LSAs in MaxAge list. It maintains the list of the all LSAs in the database which have reached the max-age which is 3600 seconds.
adv-router	Advertising Router LSA.
<adv-router-id>	The Advertising Router ID (usually entered in IPv4 address format A.B.C.D). Note that this ID component no longer represents an address; it is simply a character string that has an IPv4 address format.

Mode User Exec and Privileged Exec

Example To display the database summary for IPv6 OSPF information on process P10, use the command:

```
awplus# show ipv6 ospf P10 database
```

Output Figure 28-3: Example output from the **show ipv6 ospf P10 database** command

```
OSPFv3 Router with ID (0.0.1.1) (Process P10)

      Link-LSA (Interface eth1)

Link State ID  ADV Router      Age  Seq#           CkSum  Prefix
0.0.0.202     0.0.1.1          46  0x800000c3    0x5f50    1
0.0.0.202     0.0.1.2          8   0x800000c3    0x4ca0    1
...
```

show ipv6 ospf database external

Overview Use this command in User Exec or Privileged Exec modes to display information about the external LSAs.

For information on filtering and saving command output, see the [“Getting Started with AlliedWare Plus” Feature Overview and Configuration Guide](#).

Syntax `show ipv6 ospf database external <adv-router-id>
[self-originate|adv-router <adv-router-id>]`

Parameter	Description
<adv-router-id>	The Advertising Router ID (usually entered in IPv4 address format A.B.C.D). Note that this ID component no longer represents an address; it is simply a character string that has an IPv4 address format.
self-originate	Self-originated link states.
adv-router	Displays all the LSAs of the specified router.

Mode User Exec and Privileged Exec

Examples To display information about the external LSAs, use the following command:

```
awplus# show ipv6 ospf database external adv-router 10.10.10.1
```

Output Figure 28-4: Example output from the **show ipv6 ospf database external** command

```
LS age: 1087
LS Type: AS-External-LSA
Link State ID: 0.0.0.13
Advertising Router: 0.0.1.1
LS Seq Number: 0x8000000C
Checksum: 0xCE9D
Length: 52
  Metric Type: 2 (Larger than any link state path)
  Metric: 20
  Prefix: 2010:2222::/64
  Prefix Options: 0 (-|-|-|-)
  Forwarding Address: 2003:1111::1
...
```

show ipv6 ospf database grace

Overview Use this command in User Exec or Privileged Exec modes to display information about the grace LSAs.

For information on filtering and saving command output, see the [“Getting Started with AlliedWare Plus” Feature Overview and Configuration Guide](#).

Syntax `show ipv6 ospf database grace <adv-router-id>`
`[self-originate|adv-router <adv-router-id>]`

Parameter	Description
<adv-router-id>	The Advertising Router ID (usually entered in IPv4 address format A.B.C.D). Note that this ID component no longer represents an address; it is simply a character string that has an IPv4 address format.
adv-router	Displays all the LSAs of the specified router.
self-originate	Self-originated link states.

Mode User Exec and Privileged Exec

Examples To display information about the grace LSAs, use the following command:

```
awplus# show ipv6 ospf database grace adv-router 10.10.10.1
```

Output Figure 28-5: Example output from the **show ipv6 ospf database grace** command

```
LS age: 1087
LS Type: AS-External-LSA
Link State ID: 0.0.0.13
Advertising Router: 0.0.1.1
LS Seq Number: 0x8000000C
Checksum: 0xCE9D
Length: 52
  Metric Type: 2 (Larger than any link state path)
  Metric: 20
  Prefix: 2010:2222::/64
  Prefix Options: 0 (-|-|-|-)
  Forwarding Address: 2003:1111::1
```

show ipv6 ospf database inter-prefix

Overview Use this command in User Exec or Privileged Exec modes to display information about the inter-prefix LSAs.

For information on filtering and saving command output, see the [“Getting Started with AlliedWare Plus” Feature Overview and Configuration Guide](#).

Syntax `show ipv6 ospf database inter-prefix <adv-router-id>`
`[self-originate|adv-router <adv-router-id>]`

Parameter	Description
<code><adv-router-id></code>	The Advertising Router ID (usually entered in IPv4 address format A.B.C.D). Note that this ID component no longer represents an address; it is simply a character string that has an IPv4 address format.
<code>adv-router</code>	Displays all the LSAs of the specified router.
<code>self-originate</code>	Self-originated link states.

Mode User Exec and Privileged Exec

Examples To display information about the inter-prefix LSAs, use the following command:

```
awplus# show ipv6 ospf database external adv-router 10.10.10.1
```

Output Figure 28-6: Example output from the **show ipv6 ospf database inter-prefix** command

```
LS age: 1087
LS Type: AS-External-LSA
Link State ID: 0.0.0.13
Advertising Router: 0.0.1.1
LS Seq Number: 0x8000000C
Checksum: 0xCE9D
Length: 52
  Metric Type: 2 (Larger than any link state path)
  Metric: 20
  Prefix: 2010:2222::/64
  Prefix Options: 0 (-|-|-)
  Forwarding Address: 2003:1111::1
...
```

show ipv6 ospf database inter-router

Overview Use this command in User Exec or Privileged Exec modes to display information about the inter-router LSAs.

For information on filtering and saving command output, see the [“Getting Started with AlliedWare Plus” Feature Overview and Configuration Guide](#).

Syntax `show ipv6 ospf database inter-router <adv-router-id>`
`[self-originate] adv-router <adv-router-id>]`

Parameter	Description
<code><adv-router-id></code>	The Advertising Router ID (usually entered in IPv4 address format A.B.C.D). Note that this ID component no longer represents an address; it is simply a character string that has an IPv4 address format.
<code>adv-router</code>	Displays all the LSAs of the specified router.
<code>self-originate</code>	Self-originated link states.

Mode User Exec and Privileged Exec

Examples To display information about the inter-router LSAs, use the following command:

```
awplus# show ipv6 ospf database inter-router adv-router  
10.10.10.1
```

Output Figure 28-7: Example output from the **show ipv6 ospf database inter-router** command

```
LS age: 1087  
LS Type: AS-External-LSA  
Link State ID: 0.0.0.13  
Advertising Router: 0.0.1.1  
LS Seq Number: 0x8000000C  
Checksum: 0xCE9D  
Length: 52  
Metric Type: 2 (Larger than any link state path)  
Metric: 20  
Prefix: 2010:2222::/64  
Prefix Options: 0 (-|-|-|-)  
Forwarding Address: 2003:1111::1  
...
```

show ipv6 ospf database intra-prefix

Overview Use this command in User Exec or Privileged Exec modes to display information about the intra-prefix LSAs.

For information on filtering and saving command output, see the [“Getting Started with AlliedWare Plus” Feature Overview and Configuration Guide](#).

Syntax `show ipv6 ospf database intra-prefix <adv-router-id>
[self-originate|adv-router <adv-router-id>]`

Parameter	Description
<adv-router-id>	The Advertising Router ID (usually entered in IPv4 address format A.B.C.D). Note that this ID component no longer represents an address; it is simply a character string that has an IPv4 address format.
adv-router	Displays all the LSAs of the specified router.
self-originate	Self-originated link states.

Mode User Exec and Privileged Exec

Examples To display information about the intra-prefix LSAs, use the following command:

```
awplus# show ipv6 ospf database intra-prefix adv-router  
10.10.10.1
```

Output Figure 28-8: Example output from the **show ipv6 ospf database intra-prefix** command

```
LS age: 1087  
LS Type: AS-External-LSA  
Link State ID: 0.0.0.13  
Advertising Router: 0.0.1.1  
LS Seq Number: 0x8000000C  
Checksum: 0xCE9D  
Length: 52  
Metric Type: 2 (Larger than any link state path)  
Metric: 20  
Prefix: 2010:2222::/64  
Prefix Options: 0 (-|-|-|-)  
Forwarding Address: 2003:1111::1  
...
```

show ipv6 ospf database link

Overview Use this command in User Exec or Privileged Exec modes to display information about the link LSAs.

For information on filtering and saving command output, see the [“Getting Started with AlliedWare Plus” Feature Overview and Configuration Guide](#).

Syntax `show ipv6 ospf database link <adv-router-id>`
`[self-originate|adv-router <adv-router-id>]`

Parameter	Description
<adv-router-id>	The Advertising Router ID (usually entered in IPv4 address format A.B.C.D). Note that this ID component no longer represents an address; it is simply a character string that has an IPv4 address format.
adv-router	Displays all the LSAs of the specified router.
self-originate	Self-originated link states.

Mode User Exec and Privileged Exec

Examples To display information about the link LSAs, use the following command:

```
awplus# show ipv6 ospf database link adv-router 10.10.10.1
```

Output Figure 28-9: Example output from the **show ipv6 ospf database link** command

```
LS age: 1087
LS Type: AS-External-LSA
Link State ID: 0.0.0.13
Advertising Router: 0.0.1.1
LS Seq Number: 0x8000000C
Checksum: 0xCE9D
Length: 52
  Metric Type: 2 (Larger than any link state path)
  Metric: 20
  Prefix: 2010:2222::/64
  Prefix Options: 0 (-|-|-|-)
  Forwarding Address: 2003:1111::1
...
```

show ipv6 ospf database network

Overview Use this command in User Exec or Privileged Exec modes to display information about the network LSAs.

For information on filtering and saving command output, see the [“Getting Started with AlliedWare Plus” Feature Overview and Configuration Guide](#).

Syntax `show ipv6 ospf database network <adv-router-id>`
`[self-originate|adv-router <adv-router-id>]`

Parameter	Description
<code><adv-router-id></code>	The router ID of the advertising router, in IPv4 address format. Note, however, that this no longer represents a real address.
<code>self-originate</code>	Self-originated link states.
<code>adv-router</code>	The advertising router selected.

Mode User Exec and Privileged Exec

Examples To display information about the OSPFv3 network LSAs, use the following command:

```
awplus# show ipv6 ospf database network
```

Output Figure 28-10: Example output from the **show ipv6 ospf database network** command

```
OSPFv3 Router with ID (0.0.1.1) (Process P10)

      Network-LSA (Area 0.0.0.0)

LS age: 97
LS Type: Network-LSA
Link State ID: 0.0.0.202
Advertising Router: 0.0.1.2
LS Seq Number: 0x800000C3
Checksum: 0x92C4
Length: 32
Options: 0x000013 (-|R|-|-|E|V6)
  Attached Router: 0.0.1.2
  Attached Router: 0.0.1.1
```

```
LS age: 1144
LS Type: Network-LSA
Link State ID: 0.0.0.203
Advertising Router: 0.0.1.3
LS Seq Number: 0x800000C4
Checksum: 0x8AC8
Length: 32
Options: 0x000013 (-|R|-|-|E|V6)
  Attached Router: 0.0.1.3
  Attached Router: 0.0.1.1
```

show ipv6 ospf database router

Overview Use this command in User Exec or Privileged Exec modes to display information only about the router LSAs.

For information on filtering and saving command output, see the [“Getting Started with AlliedWare Plus” Feature Overview and Configuration Guide](#).

Syntax `show ipv6 ospf database router <adv-router-id>`
`[self-originate|adv-router <adv-router-id>]`

Parameter	Description
<code><adv-router-id></code>	The router ID of the advertising router, in IPv4 address format. Note, however, that this no longer represents a real address.
<code>self-originate</code>	Self-originated link states.
<code>adv-router</code>	The advertising router selected.

Mode User Exec and Privileged Exec

Examples To display information about the OSPFv3 router LSAs, use the following command:

```
awplus# show ipv6 ospf database router
```

Output Figure 28-11: Example output from the **show ipv6 ospf database router** command

```
OSPFv3 Router with ID (0.0.1.3) (Process P10)

      Router-LSA (Area 0.0.0.0)

LS age: 556
LS Type: Router-LSA
Link State ID: 0.0.0.0
Advertising Router: 0.0.1.1
LS Seq Number: 0x800000CA
Checksum: 0xAA23
Length: 56
Flags: 0x02 (-|-|E|-)
Options: 0x000013 (-|R|-|-|E|V6)
```

```
Link connected to: a Transit Network
  Metric: 1
  Interface ID: 203
  Neighbor Interface ID: 203
  Neighbor Router ID: 0.0.1.3

Link connected to: a Transit Network
  Metric: 1
  Interface ID: 202
  Neighbor Interface ID: 202
  Neighbor Router ID: 0.0.1.2

LS age: 520
LS Type: Router-LSA
Link State ID: 0.0.0.0
Advertising Router: 0.0.1.2
LS Seq Number: 0x800000D5
Checksum: 0xB328
Length: 40
Flags: 0x00 (-|-|-|-)
Options: 0x000013 (-|R|-|-|E|V6)

Link connected to: a Transit Network
  Metric: 1
  Interface ID: 202
  Neighbor Interface ID: 202
  Neighbor Router ID: 0.0.1.2

LS age: 543
LS Type: Router-LSA
Link State ID: 0.0.0.0
Advertising Router: 0.0.1.3
LS Seq Number: 0x800000CC
Checksum: 0xF5EA
Length: 40
Flags: 0x00 (-|-|-|-)
Options: 0x000013 (-|R|-|-|E|V6)

Link connected to: a Transit Network
  Metric: 1
  Interface ID: 203
  Neighbor Interface ID: 203
  Neighbor Router ID: 0.0.1.3
      OSPFv3 Router with ID (0.0.1.3) (Process P10)

      AS-external-LSA
```

```
LS age: 1384
LS Type: AS-External-LSA
Link State ID: 0.0.0.13
Advertising Router: 0.0.1.1
LS Seq Number: 0x80000009
Checksum: 0xD49A
Length: 52
  Metric Type: 2 (Larger than any link state path)
  Metric: 20
  Prefix: 2010:2222::/64
  Prefix Options: 0 (-|-|-|-)
  Forwarding Address: 2003:1111::1

LS age: 1384
LS Type: AS-External-LSA
Link State ID: 0.0.0.14
Advertising Router: 0.0.1.1
LS Seq Number: 0x80000009
Checksum: 0xD696
Length: 52
  Metric Type: 2 (Larger than any link state path)
  Metric: 20
  Prefix: 2011:2222::/64
  Prefix Options: 0 (-|-|-|-)
  Forwarding Address: 2003:1111::1

LS age: 1384
LS Type: AS-External-LSA
Link State ID: 0.0.0.15
Advertising Router: 0.0.1.1
LS Seq Number: 0x80000009
Checksum: 0xD892
Length: 52
  Metric Type: 2 (Larger than any link state path)
  Metric: 20
  Prefix: 2012:2222::/64
  Prefix Options: 0 (-|-|-|-)
  Forwarding Address: 2003:1111::1

LS age: 1087
LS Type: AS-External-LSA
Link State ID: 0.0.0.13
Advertising Router: 0.0.1.1
LS Seq Number: 0x8000000C
Checksum: 0xCE9D
Length: 52
  Metric Type: 2 (Larger than any link state path)
  Metric: 20
  Prefix: 2010:2222::/64
  Prefix Options: 0 (-|-|-|-)
  Forwarding Address: 2003:1111::1
```



```
LS age: 1087
LS Type: AS-External-LSA
Link State ID: 0.0.0.14
Advertising Router: 0.0.1.1
LS Seq Number: 0x8000000C
Checksum: 0xD099
Length: 52
  Metric Type: 2 (Larger than any link state path)
  Metric: 20
  Prefix: 2011:2222::/64
  Prefix Options: 0 (-|-|-|-)
  Forwarding Address: 2003:1111::1

LS age: 1087
LS Type: AS-External-LSA
Link State ID: 0.0.0.15
Advertising Router: 0.0.1.1
LS Seq Number: 0x8000000C
Checksum: 0xD295
Length: 52
  Metric Type: 2 (Larger than any link state path)
  Metric: 20
  Prefix: 2012:2222::/64
  Prefix Options: 0 (-|-|-|-)
  Forwarding Address: 2003:1111::1

LS age: 1087
LS Type: AS-External-LSA
Link State ID: 0.0.0.16
Advertising Router: 0.0.1.1
LS Seq Number: 0x8000000C
Checksum: 0xD491
Length: 52
  Metric Type: 2 (Larger than any link state path)
  Metric: 20
  Prefix: 2013:2222::/64
  Prefix Options: 0 (-|-|-|-)
  Forwarding Address: 2003:1111::1

LS age: 1087
LS Type: AS-External-LSA
Link State ID: 0.0.0.17
Advertising Router: 0.0.1.1
LS Seq Number: 0x8000000C
Checksum: 0xD68D
Length: 52
  Metric Type: 2 (Larger than any link state path)
  Metric: 20
  Prefix: 2014:2222::/64
  Prefix Options: 0 (-|-|-|-)
  Forwarding Address: 2003:1111::1
```

```
LS age: 1087
LS Type: AS-External-LSA
Link State ID: 0.0.0.18
Advertising Router: 0.0.1.1
LS Seq Number: 0x8000000C
Checksum: 0xD889
Length: 52
  Metric Type: 2 (Larger than any link state path)
  Metric: 20
  Prefix: 2015:2222::/64
  Prefix Options: 0 (-|-|-|-)
  Forwarding Address: 2003:1111::1
```

show ipv6 ospf interface

Overview Use this command in User Exec or Privileged Exec modes to display interface information for OSPF for all interfaces or a specified interface, including OSPFv3 Authentication status for all interfaces or for a specified interface.

For information on filtering and saving command output, see the [“Getting Started with AlliedWare Plus” Feature Overview and Configuration Guide](#).

Syntax `show ipv6 ospf interface [<interface-name>]`

Parameter	Description
<code><interface-name></code>	An alphanumeric string that is the interface name. Omit the optional interface to display information for all interfaces.

Mode User Exec and Privileged Exec

Examples `awplus# show ipv6 ospf interface`

Output Figure 28-12: Example output from the **show ipv6 ospf interface** command showing OSPFv3 Authentication configuration information highlighted in bold

```
awplus#show ipv6 ospf interface
eth1 is up, line protocol is up
Interface ID 302
IPv6 Prefixes
  fe80::215:77ff:fead:f87e/64 (Link-Local Address)
Security Policy
  MD5 Authentication SPI 1000
  NULL Encryption SHA-1 Auth, SPI 1001

OSPFv3 Process (10), Area 0.0.0.0, Instance ID 0
Router ID 192.168.1.2, Network Type BROADCAST, Cost: 1
Transmit Delay is 1 sec, State Backup, Priority 1
Interface state Backup
Designated Router (ID) 192.168.1.1
  Interface Address fe80::21d:e5ff:fec9:cfbe
Backup Designated Router (ID) 192.168.1.2
  Interface Address fe80::215:77ff:fead:f87e
Timer interval configured, Hello 10, Dead 40, Wait 40,
Retransmit 5
  Hello due in 00:00:07
Neighbor Count is 1, Adjacent neighbor count is 1
```

Related commands [ipv6 ospf authentication spi](#)
[ipv6 ospf encryption spi esp](#)

show ipv6 ospf neighbor

Overview Use this command in User Exec or Privileged Exec modes to display information on OSPF neighbors. Include the process ID parameter with this command to display information about specified processes.

For information on filtering and saving command output, see the [“Getting Started with AlliedWare Plus” Feature Overview and Configuration Guide](#).

Syntax `show ipv6 ospf [<process-id>] neighbor <neighbor-id>`
`show ipv6 ospf [<process-id>] neighbor detail`
`show ipv6 ospf [<process-id>] neighbor <interface> [detail]`

Parameter	Description
<process-id>	<character string> The ID of the OSPF process for which information will be displayed.
<neighbor-id>	The Neighbor ID, entered in IP address (A.B.C.D) format.
detail	Detail of all neighbors.
<interface>	IP address of the interface.

Mode User Exec and Privileged Exec

Examples `awplus# show ipv6 ospf neighbor`

Output Figure 28-13: Example output from **show ipv6 ospf neighbor**

```
awplus#show ipv6 ospf P1 neighbor 2.2.2.2
OSPFv3 Process (P1)
Neighbor ID    Pri      State                Dead Time   Interface Instance ID
2.2.2.2       5        2-Way/DROther        00:00:33   eth1          0
```

Figure 28-14: Example output from **show ipv6 ospf neighbor detail**

```
awplus#show ipv6 ospf neighbor detail
Neighbor 0.0.1.2, interface address fe80::215:77ff:fec9:7472
  In the area 0.0.0.0 via interface eth1
  Neighbor priority is 1, State is Full, 6 state changes
  DR is 0.0.1.2      BDR is 0.0.1.1
  Options is 0x000013 (-|R|-|-|E|V6)
  Dead timer due in 00:00:33
  Database Summary List 0
  Link State Request List 0
  Link State Retransmission List 0
```

show ipv6 ospf route

Overview Use this command in User Exec or Privileged Exec modes to display the OSPF routing table. Include the process ID parameter with this command to display the OSPF routing table for specified processes.

For information on filtering and saving command output, see the [“Getting Started with AlliedWare Plus” Feature Overview and Configuration Guide](#).

Syntax `show ipv6 ospf [<process-id>] route`

Parameter	Description
<code><process-id></code>	A character string that specifies the router process. If this parameter is included, only the information for this specified routing process is displayed.

Mode User Exec and Privileged Exec

Examples To display the whole OSPF routing table, use the command:

```
awplus# show ipv6 ospf route
```

Output Figure 28-15: Example output from the **show ipv6 ospf P1 route** command for a specific process

```
OSPFv3 Process (P1)
Codes: C - connected, D - Discard, O - OSPF, IA - OSPF inter area
E1 - OSPF external type 1, E2 - OSPF external type 2

Destination Metric
Next-hop
O 2002:1111::/64 2
via fe80::200:cdff:fe24:daae, eth1, Area 0.0.0.0
...
```

show ipv6 ospf virtual-links

Overview Use this command in User Exec or Privileged Exec modes to display virtual link information, including OSPFv3 Authentication status for virtual links.

For information on filtering and saving command output, see the [“Getting Started with AlliedWare Plus” Feature Overview and Configuration Guide](#).

Syntax `show ipv6 ospf virtual-links`

Mode User Exec and Privileged Exec

Usage notes See the [OSPFv3 Feature Overview and Configuration Guide](#) for more information and examples.

Examples To display virtual link information, use the command:

```
awplus# show ipv6 ospf virtual-links
```

Output Figure 28-16: Example output from the **show ipv6 ospf virtual-links** command showing OSPFv3 Authentication configuration information highlighted in bold

```
awplus#show ipv6 ospf virtual-links
Virtual Link VLINK1 to router 192.168.1.10 is down
  Transit area 0.0.0.1 via interface *, instance ID 0
  Local address
  Remote address
MD5 Authentication SPI 1000
NULL encryption SHA-1 auth SPI 1001
  Transmit Delay is 1 sec, State Down,
  Timer intervals configured, Hello 10, Dead 40, Wait 40,
  Retransmit 5
    Hello due in inactive
    Adjacency state Down
```

Related commands [area virtual-link authentication ipsec spi](#)
[area virtual-link encryption ipsec spi](#)

summary-address (IPv6 OSPF)

Overview Use this command in Router Configuration mode to summarize, or possibly suppress, external redistributed OSPFv3 routes within the specified address range.

Use the **no** variant of this command in Router Configuration mode to stop summarizing, or suppressing, external redistributed OSPFv3 routes within the specified address range.

Syntax `summary-address <ipv6-addr/prefix-length> [not-advertise] [tag <0-4294967295>]`

`no summary-address <ipv6-addr/prefix-length> [not-advertise] [tag <0-4294967295>]`

Parameter	Description
<code><ipv6-addr/prefix-length></code>	Specifies the base IPv6 address of the IPv6 summary address. The range of addresses given as IPv6 starting address and an IPv6 prefix length.
<code>not-advertise</code>	Set the not-advertise option if you do not want OSPFv3 to advertise either the summary address or the individual networks within the range of the summary address.
<code>tag <0-4294967295></code>	The tag parameter specifies the tag value that OSPFv3 places in the AS external LSAs created as a result of redistributing the summary route. The tag overrides tags set by the original route.

Default The default tag value for a summary address is 0.

Mode Router Configuration

Usage An address range is a pairing of an address and a prefix length. Redistributing routes from other protocols into OSPFv3 requires the router to advertise each route individually in an external LSA. Use this command to advertise one summary route for all redistributed routes covered by a specified prefix to decrease the size of the OSPFv3 link state database.

For example, if the specified address range is 2001:0db8:44::/48, then summary-address functionality will match 2001:0db8:4400:0000::1/128 through 2001:0db8:44ff:ffff::1/128.

Ensure OSPFv3 routes exist in the summary address range for advertisement before using this command.

Example The following example uses the `summary-address` command to aggregate external LSAs that match the IPv6 prefix `2001:0db8::/32` and assigns a tag value of 3.

```
awplus# configure terminal
awplus(config)# router ipv6 ospf
awplus(config-router)# summary-address 2001:0db8::/32 tag 3
```

The following example uses the `no summary-address` command to stop summarizing IPv6 addresses in the address range covered within the IPv6 prefix `2001:0db8::/32`.

```
awplus# configure terminal
awplus(config)# router ipv6 ospf
awplus(config-router)# no summary-address 2001:0db8::/32
```

timers spf exp (IPv6 OSPF)

Overview Use this command to adjust route calculation timers using exponential back-off delays.

Use **no** form of this command to return to the default exponential back-off timer values.

Syntax `timers spf exp <min-holdtime> <max-holdtime>`
`no timers spf exp <min-holdtime> <max-holdtime>`

Parameter	Description
<code><min-holdtime></code>	Specifies the minimum delay between receiving a change to the SPF calculation in milliseconds. The range is 0-2147483647. The default SPF min-holdtime value is 50 milliseconds.
<code><max-holdtime></code>	Specifies the maximum delay between receiving a change to the SPF calculation in milliseconds. The range is 0-2147483647. The default SPF max-holdtime value is 50 seconds.

Mode Router Configuration

Usage notes This command configures the minimum and maximum delay time between the receipt of a topology change and the calculation of the Shortest Path First (SPF). The time between SPF runs increases if a topology change occurs (and triggers a new SPF run) before the last SPF holdtimer has finished. The time between runs may increase up to the max-holdtime value. This increase in holdtime prevents too many SPF runs from occurring if multiple OSPF topology change events occur.

Examples To set the minimum delay time to 5 milliseconds and maximum delay time to 2 seconds, use the commands:

```
awplus# configure terminal
awplus(config)# router ipv6 ospf 100
awplus(config-router)# timers spf exp 5 2000
```

Related commands [show ipv6 ospf](#)

undebbug ipv6 ospf events

Overview This command applies the functionality of the no `debug ipv6 ospf events` command.

undebbug ipv6 ospf ifsm

Overview This command applies the functionality of the no `debug ipv6 ospf ifsm` command.

undebbug ipv6 ospf lsa

Overview This command applies the functionality of the no `debug ipv6 ospf lsa` command.

undebbug ipv6 ospf nfsm

Overview This command applies the functionality of the no `debug ipv6 ospf nfsm` command.

undebbug ipv6 ospf packet

Overview This command applies the functionality of the no `debug ipv6 ospf packet` command.

undebbug ipv6 ospf route

Overview This command applies the functionality of the no `debug ipv6 ospf route` command.

29

BGP and BGP4+ Commands

Introduction

Overview This chapter provides an alphabetical reference of commands used to configure the Border Gateway Protocol for IPv4 (BGP) and for IPv6 (BGP4+).

For basic BGP and BGP4+ introduction information and configuration examples, see the [Routing_Protocol Guide](#).

- Command List**
- “[address-family](#)” on page 1234
 - “[aggregate-address](#)” on page 1236
 - “[auto-summary \(BGP only\)](#)” on page 1239
 - “[bgp aggregate-next-hop-check](#)” on page 1241
 - “[bgp always-compare-med](#)” on page 1242
 - “[bgp bestpath as-path ignore](#)” on page 1244
 - “[bgp bestpath compare-confed-aspath](#)” on page 1245
 - “[bgp bestpath compare-routerid](#)” on page 1246
 - “[bgp bestpath med](#)” on page 1247
 - “[bgp bestpath med remove-recv-med](#)” on page 1249
 - “[bgp bestpath med remove-send-med](#)” on page 1250
 - “[bgp client-to-client reflection](#)” on page 1251
 - “[bgp cluster-id](#)” on page 1252
 - “[bgp confederation identifier](#)” on page 1254
 - “[bgp confederation peers](#)” on page 1255
 - “[bgp config-type](#)” on page 1257
 - “[bgp dampening](#)” on page 1259
 - “[bgp damp-peer-oscillation \(BGP only\)](#)” on page 1261

- “[bgp default ipv4-unicast](#)” on page 1262
- “[bgp default local-preference \(BGP only\)](#)” on page 1263
- “[bgp deterministic-med](#)” on page 1264
- “[bgp enforce-first-as](#)” on page 1266
- “[bgp fast-external-failover](#)” on page 1267
- “[bgp graceful-restart](#)” on page 1268
- “[bgp graceful-restart graceful-reset](#)” on page 1270
- “[bgp log-neighbor-changes](#)” on page 1271
- “[bgp memory maxallocation](#)” on page 1273
- “[bgp nexthop-trigger-count](#)” on page 1274
- “[bgp nexthop-trigger delay](#)” on page 1275
- “[bgp nexthop-trigger enable](#)” on page 1276
- “[bgp rfc1771-path-select \(BGP only\)](#)” on page 1277
- “[bgp rfc1771-strict \(BGP only\)](#)” on page 1278
- “[bgp router-id](#)” on page 1279
- “[bgp scan-time \(BGP only\)](#)” on page 1281
- “[bgp update-delay](#)” on page 1282
- “[clear bgp *](#)” on page 1283
- “[clear bgp \(IPv4 or IPv6 address\)](#)” on page 1284
- “[clear bgp \(ASN\)](#)” on page 1286
- “[clear bgp external](#)” on page 1287
- “[clear bgp peer-group](#)” on page 1288
- “[clear bgp ipv6 \(ipv6 address\) \(BGP4+ only\)](#)” on page 1289
- “[clear bgp ipv6 dampening \(BGP4+ only\)](#)” on page 1290
- “[clear bgp ipv6 flap-statistics \(BGP4+ only\)](#)” on page 1291
- “[clear bgp ipv6 \(ASN\) \(BGP4+ only\)](#)” on page 1292
- “[clear bgp ipv6 external \(BGP4+ only\)](#)” on page 1293
- “[clear bgp ipv6 peer-group \(BGP4+ only\)](#)” on page 1294
- “[clear ip bgp * \(BGP only\)](#)” on page 1295
- “[clear ip bgp \(IPv4\) \(BGP only\)](#)” on page 1297
- “[clear ip bgp dampening \(BGP only\)](#)” on page 1299
- “[clear ip bgp flap-statistics \(BGP only\)](#)” on page 1300
- “[clear ip bgp \(ASN\) \(BGP only\)](#)” on page 1301
- “[clear ip bgp external \(BGP only\)](#)” on page 1302
- “[clear ip bgp peer-group \(BGP only\)](#)” on page 1303

- [“clear ip prefix-list”](#) on page 1304
- [“debug bgp \(BGP only\)”](#) on page 1305
- [“distance \(BGP and BGP4+\)”](#) on page 1307
- [“exit-address-family”](#) on page 1309
- [“ip community-list”](#) on page 1310
- [“ip community-list expanded”](#) on page 1312
- [“ip community-list standard”](#) on page 1314
- [“ip extcommunity-list expanded”](#) on page 1316
- [“ip extcommunity-list standard”](#) on page 1318
- [“ip prefix-list”](#) on page 1320
- [“ipv6 prefix-list”](#) on page 1322
- [“match as-path”](#) on page 1324
- [“match community”](#) on page 1325
- [“max-paths”](#) on page 1327
- [“neighbor activate”](#) on page 1328
- [“neighbor advertisement-interval”](#) on page 1331
- [“neighbor allowas-in”](#) on page 1334
- [“neighbor as-origination-interval”](#) on page 1337
- [“neighbor attribute-unchanged”](#) on page 1339
- [“neighbor capability graceful-restart”](#) on page 1342
- [“neighbor capability orf prefix-list”](#) on page 1345
- [“neighbor capability route-refresh”](#) on page 1348
- [“neighbor collide-established”](#) on page 1351
- [“neighbor default-originate”](#) on page 1354
- [“neighbor description”](#) on page 1357
- [“neighbor disallow-infinite-holdtime”](#) on page 1360
- [“neighbor dont-capability-negotiate”](#) on page 1362
- [“neighbor ebgp-multihop”](#) on page 1365
- [“neighbor enforce-multihop”](#) on page 1368
- [“neighbor filter-list”](#) on page 1371
- [“neighbor interface”](#) on page 1374
- [“neighbor local-as”](#) on page 1376
- [“neighbor maximum-prefix”](#) on page 1379
- [“neighbor next-hop-self”](#) on page 1382
- [“neighbor override-capability”](#) on page 1385

- [“neighbor passive”](#) on page 1387
- [“neighbor password”](#) on page 1390
- [“neighbor peer-group \(add a neighbor\)”](#) on page 1394
- [“neighbor peer-group \(create a peer-group\)”](#) on page 1396
- [“neighbor port”](#) on page 1397
- [“neighbor prefix-list”](#) on page 1400
- [“neighbor remote-as”](#) on page 1403
- [“neighbor remove-private-AS \(BGP only\)”](#) on page 1406
- [“neighbor restart-time”](#) on page 1408
- [“neighbor route-map”](#) on page 1411
- [“neighbor route-reflector-client \(BGP only\)”](#) on page 1415
- [“neighbor route-server-client \(BGP only\)”](#) on page 1417
- [“neighbor send-community”](#) on page 1418
- [“neighbor shutdown”](#) on page 1422
- [“neighbor soft-reconfiguration inbound”](#) on page 1424
- [“neighbor timers”](#) on page 1427
- [“neighbor transparent-as”](#) on page 1430
- [“neighbor transparent-nexthop”](#) on page 1432
- [“neighbor unsuppress-map”](#) on page 1434
- [“neighbor update-source”](#) on page 1437
- [“neighbor version \(BGP only\)”](#) on page 1441
- [“neighbor weight”](#) on page 1443
- [“network \(BGP and BGP4+\)”](#) on page 1446
- [“network synchronization”](#) on page 1449
- [“redistribute \(into BGP or BGP4+\)”](#) on page 1450
- [“restart bgp graceful \(BGP only\)”](#) on page 1452
- [“router bgp”](#) on page 1453
- [“route-map”](#) on page 1454
- [“set as-path”](#) on page 1457
- [“set community”](#) on page 1458
- [“show bgp ipv6 \(BGP4+ only\)”](#) on page 1460
- [“show bgp ipv6 community \(BGP4+ only\)”](#) on page 1461
- [“show bgp ipv6 community-list \(BGP4+ only\)”](#) on page 1463
- [“show bgp ipv6 dampening \(BGP4+ only\)”](#) on page 1464
- [“show bgp ipv6 filter-list \(BGP4+ only\)”](#) on page 1465

- “show bgp ipv6 inconsistent-as (BGP4+ only)” on page 1466
- “show bgp ipv6 longer-prefixes (BGP4+ only)” on page 1467
- “show bgp ipv6 neighbors (BGP4+ only)” on page 1468
- “show bgp ipv6 paths (BGP4+ only)” on page 1471
- “show bgp ipv6 prefix-list (BGP4+ only)” on page 1472
- “show bgp ipv6 quote-regexp (BGP4+ only)” on page 1473
- “show bgp ipv6 regexp (BGP4+ only)” on page 1474
- “show bgp ipv6 route-map (BGP4+ only)” on page 1476
- “show bgp ipv6 summary (BGP4+ only)” on page 1477
- “show bgp memory maxallocation (BGP only)” on page 1478
- “show bgp nexthop-tracking (BGP only)” on page 1479
- “show bgp nexthop-tree-details (BGP only)” on page 1480
- “show debugging bgp (BGP only)” on page 1481
- “show ip bgp (BGP only)” on page 1482
- “show ip bgp attribute-info (BGP only)” on page 1483
- “show ip bgp cidr-only (BGP only)” on page 1484
- “show ip bgp community (BGP only)” on page 1485
- “show ip bgp community-info (BGP only)” on page 1487
- “show ip bgp community-list (BGP only)” on page 1488
- “show ip bgp dampening (BGP only)” on page 1489
- “show ip bgp filter-list (BGP only)” on page 1491
- “show ip bgp inconsistent-as (BGP only)” on page 1492
- “show ip bgp longer-prefixes (BGP only)” on page 1493
- “show ip bgp neighbors (BGP only)” on page 1494
- “show ip bgp neighbors connection-retrytime (BGP only)” on page 1497
- “show ip bgp neighbors hold-time (BGP only)” on page 1498
- “show ip bgp neighbors keepalive (BGP only)” on page 1499
- “show ip bgp neighbors keepalive-interval (BGP only)” on page 1500
- “show ip bgp neighbors notification (BGP only)” on page 1501
- “show ip bgp neighbors open (BGP only)” on page 1502
- “show ip bgp neighbors rcvd-msgs (BGP only)” on page 1503
- “show ip bgp neighbors sent-msgs (BGP only)” on page 1504
- “show ip bgp neighbors update (BGP only)” on page 1505
- “show ip bgp paths (BGP only)” on page 1506
- “show ip bgp prefix-list (BGP only)” on page 1507

- “show ip bgp quote-regexp (BGP only)” on page 1508
- “show ip bgp regexp (BGP only)” on page 1510
- “show ip bgp route-map (BGP only)” on page 1512
- “show ip bgp scan (BGP only)” on page 1513
- “show ip bgp summary (BGP only)” on page 1514
- “show ip community-list” on page 1516
- “show ip extcommunity-list” on page 1517
- “show ip prefix-list” on page 1518
- “show ipv6 prefix-list” on page 1519
- “show ip protocols bgp (BGP only)” on page 1520
- “show route-map” on page 1521
- “synchronization” on page 1522
- “timers (BGP)” on page 1524
- “undebug bgp (BGP only)” on page 1526

address-family

Overview This command enters the IPv4 or IPv6 Address-Family Configuration command mode. In this mode you can configure address-family specific parameters.

When using VRF-lite, you can enter IPv4 Address Family Configuration mode for a specified VRF instance before configuring that instance.

Syntax [BGP] address-family ipv4 [unicast]
no address-family ipv4 [unicast]

Syntax (VRF-lite) address-family ipv4 [unicast|vrf <vrf-name>]
no address-family ipv4 [unicast|vrf <vrf-name>]

Syntax [BGP4+] address-family ipv6 [unicast]
no address-family ipv6 [unicast]

Parameter	Description
ipv4	Configure parameters relating to the exchange of IPv4 prefixes.
ipv6	Configure parameters relating to the exchange of IPv6 prefixes.
unicast	Configure parameters relating to the exchange of routes to unicast destinations.
vrf	Applies the command to the specified VRF instance.
<vrf-name>	The name of the VRF instance to enter IPv4 Address-Family mode for.

Mode [BGP] Router Configuration

Mode [BGP4+] Router Configuration

Usage notes To leave the IPv4 or IPv6 Address Family Configuration mode, and return to the Router Configuration mode, use the [exit-address-family](#) command.

Example [BGP]

```
awplus# configure terminal
awplus(config)# router bgp 100
awplus(config-router)# neighbor 192.168.0.1 remote-as 100
awplus(config-router)# address-family ipv4 vrf
green
awplus(config-router-af)# neighbor 192.168.0.1 activate
awplus(config-router-af)# exit-address-family
awplus(config-router)#
```

Example [BGP4+] awplus# configure terminal
awplus(config)# router bgp 100
awplus(config-router)# neighbor 2001:0db8:010d::1 remote-as 100
awplus(config-router)# address-family ipv6
awplus(config-router-af)# neighbor 2001:0db8:010d::1 activate
awplus(config-router-af)# exit-address-family
awplus(config-router)#

Related commands [exit-address-family](#)

Command changes Added to AlliedWare Plus prior to 5.4.6-1
Version 5.4.6-2.1: VRF-lite support added to BGP for AR-series products
Version 5.4.7-2.1: BGP support added for IEx510, x550 series
Version 5.4.7-2.4: BGP support added for IE300 series

aggregate-address

Overview This command adds an aggregate route that can be advertised to BGP or BGP4+ neighbors. This command creates an aggregate entry in the BGP or BGP4+ routing table if the device learns, by any means, any routes that are within the range configured by the aggregate address/mask.

When this command is used with the **summary-only** option, the more-specific routes of the aggregate are suppressed to all neighbors. Use the [neighbor unsuppress-map](#) command instead to selectively leak more-specific routes to a particular neighbor.

The **no** variant of this command removes the aggregate configured by the **aggregate-address** command.

Syntax [BGP] `aggregate-address <ip-addr/m> {summary-only|as-set}`
`no aggregate-address <ip-addr/m> {summary-only|as-set}`

Syntax [BGP4+] `aggregate-address <ipv6-addr/prefix-length>`
`{summary-only|as-set}`
`no aggregate-address <ipv6-addr/prefix-length>`
`{summary-only|as-set}`

Parameter	Description
<code><ip-addr/m></code>	Specifies the aggregate IPv4 address and mask.
<code><ipv6-addr/prefix-length></code>	Specifies the aggregate IPv6 address. The IPv6 address uses the format X:X::X:Prefix-Length. The prefix-length is usually set between 0 and 64.
<code>summary-only</code>	Filters more specific routes from updates. Only the aggregate address/mask will be advertised, and none of the component addresses that fall within the range of the aggregate address/mask.
<code>as-set</code>	Generates AS set path information. The AS-path advertised with the aggregate is an unordered list of all the AS-numbers that appear in any of the AS-paths of the component routes, with each AS-number appearing just once in the list.

Mode [BGP] Router Configuration or IPv4 Address Family Configuration

Mode [BGP4+] IPv6 Address Family Configuration

Usage [BGP] If the `summary-only` parameter is specified, then only the aggregate address/mask will be advertised, and none of the component addresses that fall within the range of the aggregate address/mask. For example, if you configure:

```
awplus# configure terminal
awplus(config)# router bgp 100
awplus(config-router)# aggregate-address 172.0.0.0/8 summary-
only
```

then the device will advertise the prefix 172.0.0.0/8, but no component routes like 172.10.0.0/16

The `as-set` parameter controls the AS-path attribute that is advertised with the aggregate route. If the device has learned multiple routes that are within the range of the aggregate address/mask, and the AS-paths associated with those routes contain different sets of AS-numbers, then it is not possible to create a single AS-path that accurately represents the AS-paths of all those component routes. In this case, the device will, by default, advertise a NULL AS-path with the aggregate.

Usage [BGP4+] If the `summary-only` parameter is specified, then only the aggregate address/mask will be advertised, and none of the component addresses that fall within the range of the aggregate address/mask. For example, if you configure:

```
awplus# configure terminal
awplus(config)# router bgp 100
awplus(config-router)#address-family ipv6
awplus(config-router-af)# aggregate-address 2001:0db8::/64
summary-only
```

then the device will advertise the prefix 2001:0db8::/64, but no component routes like 2001:0db8:010d::/128

Examples [BGP]

```
awplus# configure terminal
awplus(config)# router bgp 100
awplus(config-router)# aggregate-address 192.0.0.0/8 as-set
summary-only

awplus# configure terminal
awplus(config)# router bgp 100
awplus(config-router)# no aggregate-address 192.0.0.0/8 as-set
summary-only
```

Examples
[BGP4+]

```
awplus# configure terminal
awplus(config)# router bgp 100
awplus(config-router)# address family ipv6
awplus(config-router-af)# aggregate-address 2001:0db8::/64
as-set summary-only

awplus# configure terminal
awplus(config)# router bgp 100
awplus(config-router)# address family ipv6
awplus(config-router-af)# no aggregate-address 2001:0db8::/64
as-set summary-only
```

Related commands [aggregate-address](#)
[match as-path](#)

Command changes

- Added to AlliedWare Plus prior to 5.4.6-1
- Version 5.4.7-2.1: BGP support added for IEx510, x550 series
- Version 5.4.7-2.4: BGP support added for IE300 series

auto-summary (BGP only)

Overview Use this command to enable sending summarized routes by a BGP speaker to its peers in the Router Configuration mode or in the Address-Family Configuration mode. BGP uses auto-summary to advertise summarized routes.

Use the **no** variant of this command to disable BGP auto-summary.

Syntax auto-summary
no auto-summary

Default The auto-summary function is disabled by default.

Mode Router Configuration and Address Family IPv4 mode

Usage If certain routes have already been advertised, enabling auto-summary results in non- summarized routes being withdrawn and only summarized routes are advertised. Summarized routes are advertised before non-summarized routes are withdrawn from all connected peers.

If certain routes have already been advertised, disabling auto-summary results in summarized routes being withdrawn and only non-summarized routes are advertised. Non-summarized routes are advertised before summarized routes are withdrawn from all connected peers.

Examples The following example enables auto-summary in Router Configuration mode:

```
awplus# configure
awplus(config)# router bgp 100
awplus(config-router)# auto-summary
```

The following example disables auto-summary in Router Configuration mode:

```
awplus# configure terminal
awplus(config)# router bgp 100
awplus(config-router)# no auto-summary
```

The following example enables auto-summary in Address Family IPv4 mode:

```
awplus# configure terminal
awplus(config)# router bgp 100
awplus(config-router)# address-family ipv4
awplus(config-router-af)# auto-summary
```

The following example disables auto-summary in Address Family IPv4 mode:

```
awplus# configure terminal
awplus(config)# router bgp 100
awplus(config-router)# address-family ipv4
awplus(config-router-af)# no auto-summary
```

Command changes Added to AlliedWare Plus prior to 5.4.6-1
Version 5.4.7-2.1: BGP support added for IEx510, x550 series
Version 5.4.7-2.4: BGP support added for IE300 series

bgp aggregate-nexthop-check

Overview This command affects the operation of the summary-only option on the aggregate-address command.

This command enables a mode whereby the summary-only option will only suppress the component routes if those component routes all have the same next hop. If the routes have different next hops, then they will continue to be advertised to peers even if the summary-only option is configured. By default this is disabled.

The **no** variant of this command disables this function.

Syntax `bgp aggregate-nexthop-check`
`no bgp aggregate-nexthop-check`

Default Disabled by default.

Mode Global Configuration

Example `awplus# configure terminal`
`awplus(config)# bgp aggregate-nexthop-check`

Command changes Added to AlliedWare Plus prior to 5.4.6-1
Version 5.4.7-2.1: BGP support added for IEx510, x550 series
Version 5.4.7-2.4: BGP support added for IE300 series

bgp always-compare-med

Overview This command enables BGP to compare the Multi Exit Discriminator (MED) for paths from neighbors in different autonomous systems.

Multi Exit Discriminator (MED) is used in best path selection by BGP. MED is compared after BGP attributes weight, local preference, AS-path and origin have been compared and are equal.

By default, MED comparison is done only among routes from the same autonomous system (AS). Use the **bgp always-compare-mode** command to allow comparison of MEDs from different ASs.

A path with a lower MED value is preferred. For example, if the bgp table contains the following entries, and the **bgp always-compare-med** command has been issued to enable this feature:

- Route1: as-path 400, med 300
- Route2: as-path 200, med 200
- Route3: as-path 400, med 250

Route1 is compared to Route2. Route2 is best of the two (lower MED). Next, Route2 is compared to Route3 and Route2 is chosen best path again (lower MED). If **always-compare-med** was disabled, MED is not taken into account when Route1 and Route2 are compared, because of different ASs and MED is compared for only Route1 and Route3. In this case, Route3 would be the best path. The selected route is also affected by the **bgp deterministic-med** command. See the [bgp deterministic-med](#) command for details.

If this command is used to compare MEDs for all paths, it should be configured on every BGP router in the AS.

The **no** variant of this command disallows the comparison.

Syntax `bgp always-compare-med`
`no bgp always-compare-med`

Default By default this feature is disabled.

Mode Router Configuration

Example

```
awplus# configure terminal
awplus(config)# router bgp 100
awplus(config-router)# bgp always-compare-med
```

Related commands [bgp bestpath med](#)
[bgp bestpath as-path ignore](#)
[bgp bestpath compare-routerid](#)
[bgp deterministic-med](#)

Command changes Added to AlliedWare Plus prior to 5.4.6-1
Version 5.4.7-2.1: BGP support added for IEx510, x550 series
Version 5.4.7-2.4: BGP support added for IE300 series

bgp bestpath as-path ignore

Overview This command prevents the router from considering as-path as a factor in the algorithm for choosing a route.
The **no** variant of this command allows the router to consider as-path in choosing a route.

Syntax `bgp bestpath as-path ignore`
`no bgp bestpath as-path ignore`

Mode Router Configuration

Example `awplus# configure terminal`
`awplus(config)# router bgp 100`
`awplus(config-router)# bgp bestpath as-path ignore`

Related commands [bgp always-compare-med](#)
[bgp bestpath med](#)
[bgp bestpath compare-routerid](#)

Command changes Added to AlliedWare Plus prior to 5.4.6-1
Version 5.4.7-2.1: BGP support added for IEx510, x550 series
Version 5.4.7-2.4: BGP support added for IE300 series

bgp bestpath compare-confed-aspash

Overview This command specifies that the AS confederation path length must be used, when available, in the BGP best path decision process. It is effective only when [bgp bestpath as-path ignore](#) command has not been specified.

By default, if BGP receives routes with identical eBGP paths from eBGP peers, BGP does not continue to consider any AS confederation path length attributes that may be associated with the routes.

The **no** variant of this command returns the device to the default state, where the device ignores AS confederation path length in the BGP best path selection process.

Syntax `bgp bestpath compare-confed-aspash`
`no bgp bestpath compare-confed-aspash`

Mode Router Configuration

Example

```
awplus# configure terminal
awplus(config)# router bgp 100
awplus(config-router)# bgp bestpath compare-confed-aspash
```

Related commands [bgp bestpath as-path ignore](#)

Command changes Added to AlliedWare Plus prior to 5.4.6-1
Version 5.4.7-2.1: BGP support added for IEx510, x550 series
Version 5.4.7-2.4: BGP support added for IE300 series

bgp bestpath compare-routerid

Overview By default, when comparing similar routes from peers, BGP does not consider the router ID of neighbors advertising the routes - BGP simply selects the first received route. Use this command to include router ID in the selection process; similar routes are compared and the route with the lowest router ID is selected.

The **no** variant of this command disables this feature, and returns the device to the default state, where the device ignores the router ID in the BGP best path selection process.

Syntax `bgp bestpath compare-routerid`
`no bgp bestpath compare-routerid`

Mode Router Configuration

Example

```
awplus# configure terminal
awplus(config)# router bgp 100
awplus(config-router)# bgp bestpath compare-routerid
```

Related commands [show ip bgp \(BGP only\)](#)
[show bgp ipv6 neighbors \(BGP4+ only\)](#)

Command changes Added to AlliedWare Plus prior to 5.4.6-1
Version 5.4.7-2.1: BGP support added for IEx510, x550 series
Version 5.4.7-2.4: BGP support added for IE300 series

bgp bestpath med

Overview This command controls how the Multi Exit Discriminator (MED) attribute comparison is performed.

Use the **no** variant of this command to prevent BGP from considering the MED attribute when comparing paths.

Syntax `bgp bestpath med {[confed] [missing-as-worst]}`

Parameter	Description
<code>confed</code>	Compares MED among confederation paths.
<code>missing-as-worst</code>	Treats missing MED as the least preferred one.

Mode Router Configuration

Usage The **confed** parameter enables MED comparison among paths learned from confederation peers. The MED attributes are compared only if there is no external AS (Autonomous System), where an external AS is one that is not within the confederation. If there is an external AS in the path, then the MED comparison is not made.

For example, in the following paths the MED value is not compared with `Path3` since it is not in the confederation. MED is compared for `Path1` and `Path2` only.

- `Path1 = 32000 32004, med=4`
- `Path2 = 32001 32004, med=2`
- `Path3 = 32003 1, med=1`

The effect of the **missing-as-worst** parameter is to treat a missing MED attribute in a path as having a value of infinity, making the path without a MED value the least desirable path. If the **missing-as-worst** parameter is not configured, the missing MED attribute is assigned the value of 0, making the path with the missing MED attribute the best path.

Examples

```
awplus# configure terminal
awplus(config)# router bgp 100
awplus(config-router)# bgp bestpath med missing-as-worst
awplus# configure terminal
awplus(config)# router bgp 100
awplus(config-router)# bgp bestpath med confed
awplus# configure terminal
awplus(config)# router bgp 100
awplus(config-router)# bgp bestpath med confed missing-as-worst
```

Related commands `bgp always-compare-med`
`bgp bestpath as-path ignore`
`bgp deterministic-med`

Command changes Added to AlliedWare Plus prior to 5.4.6-1
Version 5.4.7-2.1: BGP support added for IEx510, x550 series
Version 5.4.7-2.4: BGP support added for IE300 series

bgp bestpath med remove-recv-med

Overview This command removes the Multi Exit Discriminator (MED) attribute from the update messages received by the BGP speaker from its peers. However, the local BGP speaker will send MED attributes in the update messages to its peers, unless specified not to by the **bgp bestpath med remove-send-med** command.

Use the **no** variant of this command to disable this feature.

Syntax `bgp bestpath med remove-recv-med`
`no bgp bestpath med remove-recv-med`

Mode Router Configuration

Example To enable the **remove-recv-med** feature on the BGP speaker belonging to the Autonomous System (AS) 100, enter the command:

```
awplus# configure terminal
awplus(config)# router bgp 100
awplus(config-router)# bgp bestpath med remove-recv-med
```

Related commands [bgp bestpath med remove-send-med](#)

Command changes Added to AlliedWare Plus prior to 5.4.6-1
Version 5.4.7-2.1: BGP support added for IEx510, x550 series
Version 5.4.7-2.4: BGP support added for IE300 series

bgp bestpath med remove-send-med

Overview This command removes the Multi Exit Discriminator (MED) attribute from the update messages sent by the BGP speaker to its peers. However, the local BGP speaker will consider the MED attribute received from other peers during the decision and route selection process, unless specified not to by the **bgp bestpath med remove-recv-med** command.

Use the **no** variant of this command to disable this feature.

Syntax `bgp bestpath med remove-send-med`
`no bgp bestpath med remove-send-med`

Mode Router Configuration

Example To enable the **remove-send-med** feature on the BGP speaker belonging to the Autonomous System (AS) 100, enter the command:

```
awplus# configure terminal
awplus(config)# router bgp 100
awplus(config-router)# bgp bestpath med remove-send-med
```

Related commands [bgp bestpath med remove-recv-med](#)

Command changes Added to AlliedWare Plus prior to 5.4.6-1
Version 5.4.7-2.1: BGP support added for IEx510, x550 series
Version 5.4.7-2.4: BGP support added for IE300 series

bgp client-to-client reflection

Overview This command restores route reflection from a BGP route reflector to clients, and is used to configure routers as route reflectors. Route reflectors are used when all Interior Border Gateway Protocol (iBGP) speakers are not fully meshed.

If the clients are fully meshed the route reflector is not required, use the **no** variant of this command to disable the client-to-client route reflection.

When a router is configured as a route reflector, client-to-client reflection is enabled by default.

The **no** variant of this command turns off client-to-client reflection.

Syntax `bgp client-to-client reflection`
`no bgp client-to-client reflection`

Default This command is enabled by default.

Mode Router Configuration

Example

```
awplus# configure terminal
awplus(config)# router bgp 100
awplus(config-router)# no bgp client-to-client reflection
```

Related commands [bgp cluster-id](#)
[neighbor route-reflector-client \(BGP only\)](#)
[show bgp ipv6 \(BGP4+ only\)](#)
[show ip bgp \(BGP only\)](#)

Command changes Added to AlliedWare Plus prior to 5.4.6-1
Version 5.4.7-2.1: BGP support added for IEx510, x550 series
Version 5.4.7-2.4: BGP support added for IE300 series

bgp cluster-id

Overview This command configures the cluster-id if the BGP cluster has more than one route reflector. A cluster includes one or more route reflectors and their clients. Usually, each cluster is identified by the router-id of its single route reflector. However, to increase redundancy, a cluster may sometimes have more than one route reflector. All router reflectors in such a cluster are then identified by a cluster-id.

The **bgp cluster-id** command is used to configure the 4 byte cluster ID for clusters with more than one route reflector.

The **no** variant of this command removes the cluster ID.

Syntax `bgp cluster-id {<ip-address>|<cluster-id>}`
`no bgp cluster-id`

Parameter	Description
<code><cluster-id></code>	<code><1-4294967295></code> Route Reflector cluster-id as a 32 bit quantity.
<code><ip-address></code>	<code>A.B.C.D</code> Route Reflector Cluster-id in IP address format.

Mode Router Configuration

Usage The following configuration creates `cluster-id 5` including two `route-reflector-clients`.

```
awplus(config)# router bgp 200
awplus(config-router)# neighbor 2.2.2.2 remote-as 200
awplus(config-router)# neighbor 3.3.3.3 remote-as 200
awplus(config-router)# neighbor 3.3.3.3 route-reflector-client
awplus(config-router)# neighbor 5.5.5.5 remote-as 200
awplus(config-router)# neighbor 5.5.5.5 route-reflector-client
awplus(config-router)# neighbor 6.6.6.6 remote-as 200
awplus(config-router)# bgp cluster-id 5
```

Examples To add a **bgp cluster-id**, apply the example commands as shown below:

```
awplus# configure terminal
awplus(config)# router bgp 100
awplus(config-router)# bgp cluster-id 10.10.1.1
```

To remove a bgp cluster-id apply the example commands as shown below:

```
awplus# configure terminal
awplus(config)# router bgp 100
awplus(config-router)# no bgp cluster-id 10.10.1.1
```

**Related
commands**

[bgp client-to-client reflection](#)
[neighbor route-reflector-client \(BGP only\)](#)
[show bgp ipv6 \(BGP4+ only\)](#)
[show ip bgp \(BGP only\)](#)

**Command
changes**

Added to AlliedWare Plus prior to 5.4.6-1
Version 5.4.7-2.1: BGP support added for IEx510, x550 series
Version 5.4.7-2.4: BGP support added for IE300 series

bgp confederation identifier

Overview This command specifies a BGP confederation identifier.
The **no** variant of this command removes all BGP confederation identifiers.

Syntax `bgp confederation identifier <1-4294967295>`
`no bgp confederation identifier`

Parameter	Description
<code><1-4294967295></code>	Set routing domain confederation AS number.

Mode Router Configuration

Examples

```
awplus# configure terminal
awplus(config)# router bgp 100
awplus(config-router)# bgp confederation identifier 1
awplus# configure terminal
awplus(config)# router bgp 100
awplus(config-router)# no bgp confederation identifier
```

Related commands [bgp confederation peers](#)

Command changes

- Added to AlliedWare Plus prior to 5.4.6-1
- Version 5.4.7-2.1: BGP support added for IEx510, x550 series
- Version 5.4.7-2.4: BGP support added for IE300 series

bgp confederation peers

Overview This command configures the Autonomous Systems (AS) that belong to the same confederation as the current device.

A confederation allows an AS to be divided into several sub-ASs. The overall AS is given a confederation identifier. External routers view only the whole confederation as one AS, whose AS number is the confederation identifier. Each sub-AS is fully meshed within itself and is visible internally to the confederation.

Use the **bgp confederation peer** command to define the list of AS numbers of the sub-ASs in the confederation containing the current device.

The **no** variant of this command removes an autonomous system from the confederation.

Syntax `bgp confederation peers <1-4294967295>`
`no bgp confederation peers <1-4294967295>`

Parameter	Description
<code><1-4294967295></code>	AS numbers of eBGP peers that are under same confederation but in a different sub-AS.

Mode Router Configuration

Usage notes In the following configuration of **Router 1** the neighbor 172.210.30.2 and 172.210.20.1 have iBGP connection within AS 100. The neighbor 173.213.30.1 has an BGP connection, but it is within AS 200, which is part of the same confederation. The neighbor 6.6.6.6 has an eBGP connection to external AS 500.

In the configuration of **Router 2**, neighbor 5.5.5.4 has an eBGP connection to confederation 300. Router2 does not know about the ASs 100 and 200, it only knows about confederation 300.

Router 1

```
awplus(config)# router bgp 100
awplus(config-router)# bgp confederation identifier 300
awplus(config-router)# bgp confederation peers 200
awplus(config-router)# neighbor 172.210.30.2 remote-as 100
awplus(config-router)# neighbor 172.210.20.1 remote-as 100
awplus(config-router)# neighbor 173.213.30.1 remote-as 200
awplus(config-router)# neighbor 6.6.6.6 remote-as 300
```

Router 2

```
awplus(config)# router bgp 500
awplus(config-router)# neighbor 5.5.5.4 remote-as 300
```

Example awplus# configure terminal
awplus(config)# router bgp 100
awplus(config-router)# bgp confederation peers 1234

Related commands [bgp confederation identifier](#)

Command changes Added to AlliedWare Plus prior to 5.4.6-1
Version 5.4.7-2.1: BGP support added for IEx510, x550 series
Version 5.4.7-2.4: BGP support added for IE300 series

bgp config-type

Overview Use this command to set the BGP configuration type to either **standard** or **enhanced** types. When you configure the **enhanced** type, then BGP and BGP4+ communities are allowed to be sent and received by default. The **enhanced** type is configured by default.

Use the **no** variant of this command to restore the default BGP configuration type (**enhanced**).

Syntax `bgp config-type {standard|enhanced}`
`no bgp config-type`

Parameter	Description
standard	Specifies the industry standard style configuration. After setting the configuration to standard, make sure to use the neighbor send-community command to send out BGP community attributes. The synchronization command is enabled in the Global Configuration mode and is shown in the configuration.
enhanced	Specifies the enhanced style configuration. The enhanced configuration type requires no specific configuration for sending out BGP standard community and extended community attributes. The synchronization command is enabled by default in the Global Configuration mode and is not shown in configuration output.

Default By default, the BGP configuration type is **enhanced**.

Mode Global Configuration

Usage notes Note that the **enhanced** type default configuration may cause issues in some networks if unauthorized BGP peers are advertising BGP communities to adjust routing decisions.

Changing modes requires you to **reload** your device for the change to take effect:

```
awplus(config)#bgp config-type standard
awplus(config)#exit
awplus#reload
reboot system? (y/n): y
```

When your device reloads, it will load with the standard BGP settings commonly used by most vendors. Apply the **standard** type configuration if you have interoperability issues.

Examples To specify the standard BGP configuration type, enter the following commands:

```
awplus# configure terminal
awplus(config)# bgp config-type standard
```

To specify the enhanced BGP configuration type, enter the following commands:

```
awplus# configure terminal  
awplus(config)# bgp config-type enhanced
```

To restore the default BGP configuration type (enhanced), enter the following commands:

```
awplus# configure terminal  
awplus(config)# no bgp config-type
```

Related commands [neighbor send-community synchronization](#)

Command changes Added to AlliedWare Plus prior to 5.4.6-1
Version 5.4.7-2.1: BGP support added for IEx510, x550 series
Version 5.4.7-2.4: BGP support added for IE300 series

bgp dampening

Overview This command enables BGP and BGP4+ dampening and sets BGP and BGP4+ dampening parameters. BGP4+ dampening is available from the IPv6 Address Family Configuration mode. BGP dampening is available from the Router Configuration mode.

The **no** variant of this command disables BGP dampening or unsets the BGP dampening parameters.

Syntax

```
bgp dampening
no bgp dampening
bgp dampening <reachtime>
no bgp dampening <reachtime>
bgp dampening <reachtime> <reuse> <suppress> <maxsuppress>
<unreachtime>
no bgp dampening <reachtime> <reuse> <suppress> <maxsuppress>
<unreachtime>
bgp dampening route-map <routemap-name>
no bgp dampening route-map <routemap-name>
```

Parameter	Description
<reachtime>	<1-45> Specifies the reachability half-life time in minutes. The time for the penalty to decrease to one-half of its current value. The default is 15 minutes.
<reuse>	<1-20000> Specifies the reuse limit value. When the penalty for a suppressed route decays below the reuse value, the routes become unsuppressed. The default reuse limit is 750
<suppress>	<1-20000> Specifies the suppress limit value. When the penalty for a route exceeds the suppress value, the route is suppressed. The default suppress limit is 2000.
<maxsuppress>	<1-255> Specifies the max-suppress-time. Maximum time that a dampened route is suppressed. The default max-suppress value is 4 times the half-life time (60 minutes).
<unreachtime>	<1-45> Specifies the un-reachability half-life time for penalty, in minutes.
route-map	Route-map to specify criteria for dampening.
<routemap-name>	Specify the name of the route-map.

Mode [BGP] Router Configuration

Mode [BGP4+] IPv6 Address Family Configuration

Usage notes Route dampening minimizes the instability caused by route flapping. A penalty is added for every flap in a flapping route. As soon as the total penalty reaches the **suppress** limit the advertisement of the route is suppressed. This penalty is decayed according to the configured **half time** value. Once the penalty is lower than the **reuse** limit, the route advertisement is un-suppressed.

The dampening information is purged from the router once the penalty becomes less than half of the **reuse** limit.

Example [BGP]

```
awplus# configure terminal
awplus(config)# router bgp 11
awplus(config-router)# bgp dampening 20 800 2500 80 25
```

Example [BGP4+]

```
awplus# configure terminal
awplus(config)# router bgp 11
awplus(config-router)# address-family ipv6
awplus(config-router-af)# bgp dampening 20 800 2500 80 25
```

Command changes

- Added to AlliedWare Plus prior to 5.4.6-1
- Version 5.4.7-2.1: BGP support added for IEx510, x550 series
- Version 5.4.7-2.4: BGP support added for IE300 series

bgp damp-peer-oscillation (BGP only)

Overview Use this command to enable BGP peer oscillating connection damping.
Use the **no** variant of this command to disable BGP peer oscillating connection damping.

Syntax `bgp damp-peer-oscillations`
`no bgp damp-peer-oscillations`

Default By default, this functionality is enabled and will not appear in the **show running-config** command output.

Mode Router Configuration

Usage BGP peers in AlliedWare Plus will automatically attempt to form connections with configured neighbors. Due to misconfiguration these connections may fail and continue to fail until such time as the misconfiguration is detected and fixed. During this time, BGP can quickly cycle through the state machine from Idle through the various Connect states, which can result in large numbers of TCP sessions being opened in a short period of time.

This command instead adds a delay after a peer enters the Idle state before it can progress to the later states. The default delay is 0 second, increasing by 1 second for each unsuccessful connection attempt, to a maximum of 5 seconds. After a successful BGP route update has been received over a connection, the delay will be reset to 0. This command implements the DampPeerOscillations FSM behavior described in section 8.1 of RFC 4271.

The command is enabled by default. When disabled, peers will transition out of the Idle state immediately. The command applies globally to all currently configured BGP peers and all future peers to be created.

Example To disable peer connection damping, use the commands:

```
awplus# configure terminal
awplus(config)# router bgp 1
awplus(config-router)# no bgp damp-peer-oscillations
```

Command changes Added to AlliedWare Plus prior to 5.4.6-1
Version 5.4.7-2.1: BGP support added for IEx510, x550 series
Version 5.4.7-2.4: BGP support added for IE300 series

bgp default ipv4-unicast

Overview This command configures BGP defaults and activates IPv4-unicast for a peer by default. This affects BGP global configuration. By default, BGP exchanges IPv4 prefixes with a peer.

The **no** variant of this command disables this function. The BGP routing process will no longer exchange IPv4 addressing information with BGP neighbor routers. Note that disabling the exchange of IPv4 prefixes will also enable an IPv6 only BGP4+ network.

Syntax `bgp default ipv4-unicast`
`no bgp default ipv4-unicast`

Default This is enabled by default.

Mode Router Configuration

Usage Use the negated form of this command to enable an IPv6 only BGP4+ network.

Examples

```
awplus# configure terminal
awplus(config)# router bgp 100
awplus(config-router)# bgp default ipv4-unicast
awplus# configure terminal
awplus(config)# router bgp 100
awplus(config-router)# no bgp default ipv4-unicast
```

Command changes

- Added to AlliedWare Plus prior to 5.4.6-1
- Version 5.4.7-2.1: BGP support added for IEx510, x550 series
- Version 5.4.7-2.4: BGP support added for IE300 series

bgp default local-preference (BGP only)

Overview This command changes the default local preference value.

The local preference indicates the preferred path when there are multiple paths to the same destination. The path with the higher preference is preferred.

Use this command to define the default local preference value that the device will advertise for the routes it sends. The preference is sent to all routers and access servers in the local autonomous system.

The **no** variant of this command reverts to the default local preference value of 100.

Syntax `bgp default local-preference <pref-value>`
`no bgp default local-preference [<pref-value>]`

Parameter	Description
<code><pref-value></code>	<code><0-4294967295></code> Configure default local preference value. The default local preference value is 100.

Default By default the local-preference value is 100.

Mode Router Configuration

Examples

```
awplus# configure terminal
awplus(config)# router bgp 100
awplus(config-router)# bgp default local-preference 2345555
awplus# configure terminal
awplus(config)# router bgp 100
awplus(config-router)# no bgp default local-preference
```

Command changes Added to AlliedWare Plus prior to 5.4.6-1
Version 5.4.7-2.1: BGP support added for IEx510, x550 series
Version 5.4.7-2.4: BGP support added for IE300 series

bgp deterministic-med

Overview Use this command to allow or disallow the device to compare the Multi Exit Discriminator (MED) variable when choosing among routes advertised by different peers in the same autonomous system (AS).

Use the **bgp deterministic-med** command to enable this feature to allow the comparison of MED variables when choosing among routes advertised by different peers in the same AS.

Use the **no** variant of this command to disable this feature to disallow the comparison of the MED variable when choosing among routes advertised by different peers in the same AS.

Syntax `bgp deterministic-med`
`no bgp deterministic-med`

Default Disabled

Mode Router Configuration

Usage When the **bgp deterministic-med** command is enabled, routes from the same AS are grouped together and ordered according to their MED values, and the best routes of each group are compared.

The main benefit of this is that the choice of best route then does not depend on the order in which the routes happened to be received, which is rather random and arbitrary.

To see how this works, consider the following set of bgp table entries, all for the same route:

```
1: ASPATH 234, MED 120, internal, IGP metric to NEXT_HOP 40
2: ASPATH 389, MED 190, internal, IGP metric to NEXT_HOP 35
3: ASPATH 234, MED 245, external
```

If **bgp deterministic-med** is not enabled, then entry 3 will be chosen, because it is an external route.

But if BGP deterministic-MED is enabled, the entries will be grouped as follows:

```
Group 1: 1: ASPATH 234, MED 120, internal, IGP metric to NEXT_HOP 40
          3: ASPATH 234, MED 245, external
Group 2: 2: ASPATH 389, MED 190, internal, IGP metric to NEXT_HOP 35
```

NOTE: Routes from the same AS are grouped together and ordered by MED.

Entry 1 is chosen as the best route from Group 1, since this route has the lowest MED value. Entry 2 has to be the best route in Group 2, since this is the only route in that group. These two group winners are compared against each other, and

Entry 2 is chosen as the best route because Entry 2 has the lower metric to next-hop.

All routers in an AS should have the same setting for BGP deterministic-MED. All routers in an AS should have BGP deterministic-MED enabled with **bgp deterministic-med**, or all routers in an AS should have BGP deterministic-MED disabled with **no bgp-deterministic-med**.

In the example above, the MED values were not considered when comparing the winners of the two groups (the best routes from the different ASs). To use MED in the comparison of routes from different ASs, use the [bgp always-compare-med](#) command.

Examples

```
awplus# configure terminal
awplus(config)# router bgp 100
awplus(config-router)# bgp deterministic-med
awplus# configure terminal
awplus(config)# router bgp 100
awplus(config-router)# no bgp deterministic-med
```

Related commands

- [show ip bgp \(BGP only\)](#)
- [show bgp ipv6 neighbors \(BGP4+ only\)](#)
- [show ip bgp neighbors \(BGP only\)](#)

Command changes

- Added to AlliedWare Plus prior to 5.4.6-1
- Version 5.4.7-2.1: BGP support added for IEx510, x550 series
- Version 5.4.7-2.4: BGP support added for IE300 series

bgp enforce-first-as

Overview Use this command to enforce the denying of eBGP updates in which the neighbor's AS number is not the first AS in the AS-path attribute.

Use the **no** variant of this command to disable this feature.

Syntax `bgp enforce-first-as`
`no bgp enforce-first-as`

Mode Router Configuration

Usage This command specifies that any updates received from an external neighbor that do not have the neighbor's configured Autonomous System (AS) at the beginning of the AS_PATH in the received update must be denied. Enabling this feature adds to the security of the BGP network by not allowing traffic from unauthorized systems.

Example

```
awplus# configure terminal
awplus(config)# router bgp 100
awplus(config-router)# bgp enforce-first-as
```

Command changes Added to AlliedWare Plus prior to 5.4.6-1
Version 5.4.7-2.1: BGP support added for IEx510, x550 series
Version 5.4.7-2.4: BGP support added for IE300 series

bgp fast-external-failover

Overview Use this command to reset a BGP session immediately if the interface used for BGP connection goes down.

Use the **no** variant of this command to disable this feature.

Syntax `bgp fast-external-failover`
`no bgp fast-external-failover`

Default Enabled

Mode Router Configuration

Example `awplus# configure terminal`
`awplus(config)# router bgp 100`
`awplus(config-router)# bgp fast-external-failover`

Command changes Added to AlliedWare Plus prior to 5.4.6-1
Version 5.4.7-2.1: BGP support added for IEx510, x550 series
Version 5.4.7-2.4: BGP support added for IE300 series

bgp graceful-restart

Overview Use this command to enable BGP and BGP4+ graceful-restart capabilities for restart and stalepath times.

Use the **no** variant of this command to restore restart timers to their default settings.

Syntax `bgp graceful-restart [restart-time <delay-value>|
stalepath-time <delay-value>]`
`no bgp graceful-restart [restart-time|stalepath-time]`

Parameter	Description
<code>restart-time</code>	The maximum time needed for neighbors to restart, in seconds. The default restart-time is 120 seconds.
<code>stalepath-time</code>	The maximum time to retain stale paths from restarting neighbors, in seconds. The default stalepath-time is 120 seconds.
<code><delay-value></code>	<1-3600> Maximum time in seconds.

Default Graceful restart is disabled by default. If you enable it and do not specify the restart-time and stalepath-time, they default to 120 seconds.

Mode Router Configuration

Usage notes The **restart-time** parameter is used for setting the maximum time that a graceful-restart neighbor waits to come back up after a restart. This **restart-time** value is applied to neighbors unless you explicitly override it by configuring the corresponding value on the neighbor.

The **stalepath-time** parameter is used to set the maximum time to preserve stale paths from a gracefully restarted neighbor. All stalepaths, unless reinstated by the neighbor after a re-establishment, will be deleted when time, as specified by the **stalepath-time** parameter, expires.

Examples To enable graceful restart, use the commands:

```
awplus# configure terminal
awplus(config)# router bgp 10
awplus(config-router)# bgp graceful-restart
```

To disable graceful restart, use the commands:

```
awplus# configure terminal
awplus(config)# router bgp 10
awplus(config-router)# no bgp graceful-restart
```

To enable graceful restart and set the restart time to 150 seconds, use the commands:

```
awplus# configure terminal
awplus(config)# router bgp 10
awplus(config-router)# bgp graceful-restart restart-time 150
```

To return the restart-time to its default of 120 seconds, use the commands:

```
awplus# configure terminal
awplus(config)# router bgp 10
awplus(config-router)# no bgp graceful-restart restart-time
```

Related commands [bgp graceful-restart graceful-reset restart bgp graceful \(BGP only\)](#)

Command changes Added to AlliedWare Plus prior to 5.4.6-1
Version 5.4.7-2.1: BGP support added for IEx510, x550 series
Version 5.4.7-2.4: BGP support added for IE300 series

bgp graceful-restart graceful-reset

Overview This command enables BGP and BGP4+ graceful-restart when a configuration change forces a peer restart.

Use the **no** variant of this command to restore the device to its default state.

Syntax `bgp graceful-restart graceful-reset`
`no bgp graceful-restart graceful-reset`

Default Disabled

Mode Router Configuration

Usage The `bgp graceful-restart` command must be enabled before this command is enabled. All events that cause BGP peer reset, including all session reset commands, can trigger graceful-restart.

Example To enable the graceful-restart graceful-reset feature on the BGP or BGP4+ peer belonging to Autonomous System (AS) 10, use the commands:

```
awplus# configure terminal
awplus(config)# router bgp 10
awplus(config-router)# bgp graceful-restart graceful-reset
```

To disable the graceful-restart graceful-reset feature on the BGP or BGP4+ peer belonging to Autonomous System (AS) 10, use the commands:

```
awplus# configure terminal
awplus(config)# router bgp 10
awplus(config-router)# no bgp graceful-restart graceful-reset
```

Related commands [bgp graceful-restart](#)

Command changes Added to AlliedWare Plus prior to 5.4.6-1
Version 5.4.7-2.1: BGP support added for IEx510, x550 series
Version 5.4.7-2.4: BGP support added for IE300 series

bgp log-neighbor-changes

Overview Use this command to enable logging of status change messages without turning on **debug bgp** commands.

Use the **no** variant of this command to disable this feature.

Syntax `bgp log-neighbor-changes`
`no bgp log-neighbor-changes`

Default Disabled

Mode Router Configuration

Usage notes AlliedWare Plus™ provides other kinds of logging services for neighbor status, for example, **debug bgp fsm** and **debug bgp events**.

However, these commands create a significant hit in the logging performance. If you need to log neighbor status changes only, we recommend turning off all the debug commands, and then use this command.

To see BGP neighbor changes in the log you must also set the log level to informational using the **log buffered** command.

A sample output of this log is:

```
%Protocol-Severity-Events: Message-text
```

A sample output of the log for an interface down event is:

```
%BGP-5-ADJCHANGE: neighbor 10.10.0.24 Down Interface flap
```

The **bgp log-neighbor-changes** command logs the following events:

- BGP Notification Received
- Erroneous BGP Update Received
- User reset request
- Peer time-out
- Peer Closing down the session
- Interface flap
- Router ID changed
- Neighbor deleted
- Member added to peer group
- Administrative shutdown

- Remote AS changed
- RR client configuration modification
- Soft reconfiguration modification

Example To enable the logging of BGP status changes without using the debug bgp command:

```
awplus# configure terminal
awplus(config)# router bgp 100
awplus(config-router)# bgp log-neighbor-changes
```

Command changes Added to AlliedWare Plus prior to 5.4.6-1
Version 5.4.7-2.1: BGP support added for IEx510, x550 series
Version 5.4.7-2.4: BGP support added for IE300 series

bgp memory maxallocation

Overview This command allocates a maximum percentage of the RAM (Random Access Memory) available on the device for BGP processes.

When this percentage is exceeded, BGP peering terminates and an **out of resources** error displays. The default setting for **bgp memory maxallocation** is 100% memory allocation.

Use the **no** variant of this command to reset memory allocation to the default.

Syntax `bgp memory maxallocation <1-100>`
`no bgp memory maxallocation`

Parameter	Description
<1-100>	Percentage of device memory allocated to BGP processes. Note this is RAM (Random Access Memory), not device flash memory.

Default BGP processes are allocated the maximum percentage of 100% of the device's available RAM memory by default. Note only non-default BGP memory allocation values are shown in the running or startup configuration files:

```
awplus#show running-config
!
bgp memory maxallocation 50
!
```

Mode Global Configuration

Examples To limit the maximum amount of memory used by BGP processes to 65% of the total RAM memory available on the device, use the commands:

```
awplus# configure terminal
awplus(config)# bgp memory maxallocation 65
```

To return to the default 100% maximum RAM memory allocation available on the device for BGP processes, use the commands:

```
awplus# configure terminal
awplus(config)# no bgp memory maxallocation
```

Command changes Added to AlliedWare Plus prior to 5.4.6-1
Version 5.4.7-2.1: BGP support added for IEx510, x550 series
Version 5.4.7-2.4: BGP support added for IE300 series

bgp nexthop-trigger-count

Overview Use this command to configure the display of BGP next hop tracking status.
Use the **no** variant of this command to disable this function.

Syntax `bgp nexthop-trigger-count <0-127>`
`no bgp nexthop-trigger-count`

Parameter	Description
<0-127>	BGP next hop tracking status.

Mode Router Configuration

Example To enable next-hop-tracking status on the BGP peer belonging to the Autonomous System (AS) 100, enter the following commands:

```
awplus# configure terminal
awplus(config)# router bgp 100
awplus(config-router)# bgp nexthop-trigger-count 10
```

To disable next-hop-tracking status, enter the following commands:

```
awplus# configure terminal
awplus(config)# router bgp 100
awplus(config-router)# no bgp nexthop-trigger-count
```

Related commands [bgp nexthop-trigger delay](#)
[bgp nexthop-trigger enable](#)
[show bgp nexthop-tracking \(BGP only\)](#)

Command changes Added to AlliedWare Plus prior to 5.4.6-1
Version 5.4.7-2.1: BGP support added for IEx510, x550 series
Version 5.4.7-2.4: BGP support added for IE300 series

bgp nexthop-trigger delay

Overview Use this command to set the delay interval for next hop address tracking.
Use the **no** variant of this command to reset the timer value to the default.

Syntax `bgp nexthop-trigger delay <1-100>`
`no bgp nexthop-trigger delay`

Parameter	Description
<1-100>	Next hop trigger delay interval in seconds.

Default The default next hop delay interval is 5 seconds.

Mode Global Configuration

Usage This command configures the delay interval between routing table waits for next hop delay tracking. The delay interval determines how long BGP waits after it receives the trigger from the system about one or more next hop changes before it walks the full BGP table to determine which prefixes are affected by the next hop changes.

Example To set the next hop delay interval to 6 seconds, enter the command:

```
awplus# configure terminal  
awplus(config)# bgp nexthop-trigger delay 6
```

Related commands [bgp nexthop-trigger-count](#)
[bgp nexthop-trigger enable](#)

Command changes Added to AlliedWare Plus prior to 5.4.6-1
Version 5.4.7-2.1: BGP support added for IEx510, x550 series
Version 5.4.7-2.4: BGP support added for IE300 series

bgp nexthop-trigger enable

Overview Use this command to enable next hop address tracking. If next hop address tracking is enabled and a next hop trigger delay interval has not been explicitly set with the [bgp nexthop-trigger delay](#) command, the default delay interval of 5 seconds is used.

Use the **no** variant of this command to disable this feature.

Syntax `bgp nexthop-trigger enable`
`no bgp nexthop-trigger enable`

Default Disabled.

Mode Global Configuration

Usage Next hop address tracking is an event driven notification system that monitors the status of routes installed in the Routing Information Base (RIB) and reports next hop changes that affect internal BGP (iBGP) or external BGP (eBGP) prefixes directly to the BGP process. This improves the overall BGP convergence time, by allowing BGP to respond rapidly to next hop changes for routes installed in the RIB.

If next hop tracking is enabled after certain routes are learned, the registration of all the next hops of selected BGP routes are done immediately after the next hop tracking feature is enabled.

If next hop tracking is disabled, and if there are still some selected BGP routes, BGP deregisters the next hops of all of the selected BGP routes from the system.

If next hop tracking is disabled when next hop tracking is in the process of execution, an error appears, and next hop tracking is not disabled. However, if the next hop tracking timer is running at the time of negation, the next hop tracking timer is stopped, and next hop tracking is disabled.

Example To enable next hop address tracking, enter the command:

```
awplus# configure terminal
awplus(config)# bgp nexthop-trigger enable
```

Related commands [bgp nexthop-trigger-count](#)
[bgp nexthop-trigger delay](#)
[show bgp nexthop-tracking \(BGP only\)](#)

Command changes Added to AlliedWare Plus prior to 5.4.6-1
Version 5.4.7-2.1: BGP support added for IEx510, x550 series
Version 5.4.7-2.4: BGP support added for IE300 series

bgp rfc1771-path-select (BGP only)

Overview Use this command to set the RFC1771 compatible path selection mechanism.

Use the **no** variant of this command to revert this setting.

Syntax `bgp rfc1771-path-select`
`no bgp rfc1771-path-select`

Default Industry standard compatible path selection mechanism.

Mode Global Configuration

Example `awplus# configure terminal`
`awplus(config)# bgp rfc1771-path-select`

Command changes Added to AlliedWare Plus prior to 5.4.6-1
Version 5.4.7-2.1: BGP support added for IEx510, x550 series
Version 5.4.7-2.4: BGP support added for IE300 series

bgp rfc1771-strict (BGP only)

Overview Use this command to set the Strict RFC1771 setting.
Use the **no** variant of this command to revert this setting.

Syntax `bgp rfc1771-strict`
`no bgp rfc1771-strict`

Default Disabled

Mode Global Configuration

Example `awplus# configure terminal`
`awplus(config)# bgp rfc1771-strict`

Command changes Added to AlliedWare Plus prior to 5.4.6-1
Version 5.4.7-2.1: BGP support added for IEx510, x550 series
Version 5.4.7-2.4: BGP support added for IE300 series

bgp router-id

Overview Use this command to configure the router identifier. The IPv4 address specified in this command does not have to be an IPv4 address that is configured on any of the interfaces on the device. Note that you must specify an IPv4 address with this when used for BGP4+.

Use the **no** variant of this command to return the router-id to its default value (as described in Default below).

Syntax `bgp router-id <routerid>`
`no bgp router-id [<routerid>]`

Parameter	Description
<code><routerid></code>	Specify the IPv4 address without mask for a manually configured router ID, in the format A.B.C.D.

Default If the BGP router ID is not specified, the IPv4 address of the loopback interface is used. When there is no address on the loopback interface, the highest IP address among the other interfaces is used.

Mode [BGP] Router Configuration or IPv4 Address Family Configuration

Mode [BGP4+] Router Configuration

Usage Use the **bgp router-id** command to manually configure a fixed router ID as a BGP or BGP4+ router identifier. This router ID takes precedence over all other possible router ID sources. The order of precedence is:

- 1) router ID configured with this command
- 2) IP address of the loopback interface
- 3) highest IP address from the other interfaces

Examples To configure a router ID with an IPv4 address for a BGP or BGP4+ router identifier, enter the commands listed below:

```
awplus# configure terminal
awplus(config)# router bgp 100
awplus(config-router)# bgp router-id 1.1.2.3
```

To disable the router ID for a BGP or BGP4+ router identifier enter the commands listed below:

```
awplus# configure terminal
awplus(config)# router bgp 100
awplus(config-router)# no bgp router-id
```

Command changes Added to AlliedWare Plus prior to 5.4.6-1
Version 5.4.7-2.1: BGP support added for IEx510, x550 series
Version 5.4.7-2.4: BGP support added for IE300 series

bgp scan-time (BGP only)

Overview Use this command to set the interval for BGP route next-hop scanning.
Use the **no** variant of this command to disable this function.

Syntax `bgp scan-time <time>`
`no bgp scan-time [<time>]`

Parameter	Description
<time>	<0-60> Scanning interval in seconds.

Default The default scanning interval is 60 seconds.

Mode Router Configuration

Usage Use this command to configure scanning intervals of BGP routers. This interval is the period after which router checks the validity of the routes in its database.

To disable BGP scanning, set the scan time interval to 0 seconds.

Example `awplus# configure terminal`
`awplus(config)# router bgp 100`
`awplus(config-router)# bgp scan-time 10`

Command changes Added to AlliedWare Plus prior to 5.4.6-1
Version 5.4.7-2.1: BGP support added for IEx510, x550 series
Version 5.4.7-2.4: BGP support added for IE300 series

bgp update-delay

Overview Use this command to specify the update-delay value for a graceful-restart capable router.

Use the **no** variant of this command to revert to the default update-delay value.

Syntax `bgp update-delay <1-3600>`
`no bgp update-delay [<1-3600>]`

Parameter	Description
<1-3600>	Delay value in seconds.

Default The default update-delay value is 120 seconds.

Mode Router Configuration

Usage The update-delay value is the maximum time a graceful-restart capable router which is restarting will defer route-selection and advertisements to all its graceful-restart capable neighbors. This maximum time starts from the instance the first neighbor attains established state after restart. The restarting router prematurely terminates this timer when end-of-rib markers are received from all its graceful-restart capable neighbors.

Example

```
awplus# configure terminal
awplus(config)# router bgp 10
awplus(config-router)# bgp update-delay 345
```

Command changes Added to AlliedWare Plus prior to 5.4.6-1
Version 5.4.7-2.1: BGP support added for IEx510, x550 series
Version 5.4.7-2.4: BGP support added for IE300 series

clear bgp *

Overview Use this command to reset the BGP and BGP4+ connections for all peers.

Syntax clear bgp *
clear bgp * in [prefix-filter]
clear bgp * out
clear bgp * soft [in|out]

Parameter	Description
*	Clears all BGP and BGP4+ peers.
in	Indicates that incoming advertised routes will be cleared.
prefix-filter	Specifies that a prefix-list will be sent, by the ORF mechanism, to those neighbors with which the ORF capability has been negotiated. The neighbors will be triggered to resend updates, which match the prefix-list filter, to the local router. The local router will then perform a soft reconfiguration.
out	Indicates that outgoing advertised routes will be cleared.
soft in	Soft inbound reset causes the neighbors to resend all their updates to the local device, without resetting the connection or clearing the entries in the local device. So, the local device stores new updates, and uses them to systematically replace existing table entries. This process can use a considerable amount of memory.
soft out	Soft outbound reset causes the device to simply resend all its updates to the specified neighbor(s), without resetting the connection, or clearing table entries.

Mode Privileged Exec

Examples awplus# clear bgp * soft in
awplus# clear bgp * in prefix-filter

Command changes Added to AlliedWare Plus prior to 5.4.6-1
Version 5.4.7-2.1: BGP support added for IEx510, x550 series
Version 5.4.7-2.4: BGP support added for IE300 series

clear bgp (IPv4 or IPv6 address)

Overview Use this command to reset the BGP and BGP4+ connections for specified peers.

When VRF-lite is configured, you can apply this command to a specific VRF instance. This command resets all BGP connections from any address family (from either IPv4 or IPv6 Address Families).

Syntax [BGP]

```
clear bgp <ip-addr>  
clear bgp <ip-addr> in [prefix-filter]  
clear bgp <ip-addr> out  
clear bgp <ip-addr> soft [in|out]
```

Syntax (VRF-lite) `clear ip bgp <ip-addr> [vrf <vrf-name>] [in|out|soft [in|out]]`

Syntax [BGP4+]

```
clear bgp <ipv6-addr>  
clear bgp <ipv6-addr> in [prefix-filter]  
clear bgp <ipv6-addr> out  
clear bgp <ipv6-addr> soft [in|out]
```

Parameter	Description
<ip-addr>	Specifies the IPv4 address of the neighbor whose connection is to be reset, entered in the form A.B.C.D.
<ipv6-addr>	Specifies the IPv6 address of the neighbor whose connection is to be reset, entered in hexadecimal in the format X:X::X:X.
in	Indicates that incoming advertised routes will be cleared.
prefix-filter	Specifies that a prefix-list will be sent, by the ORF mechanism, to those neighbors with which the ORF capability has been negotiated. The neighbors will be triggered to resend updates, which match the prefix-list filter, to the local router. The local router will then perform a soft reconfiguration.
out	Indicates that outgoing advertised routes will be cleared.
soft in	Soft inbound reset causes the neighbors to resend all their updates to the local device, without resetting the connection or clearing the entries in the local device. So, the local device stores new updates, and uses them to systematically replace existing table entries. This process can use a considerable amount of memory.
soft out	Soft outbound reset causes the device to simply resend all its updates to the specified neighbor(s), without resetting the connection, or clearing table entries.
vrf	Applies the command to the specified VRF instance.
<vrf-name>	The name of the VRF instance.

Mode Privileged Exec

Examples [BGP] awplus# clear bgp 3.3.3.3 soft in prefix-filter
awplus# clear bgp 2.2.2.2 out

Example (VRF-lite) To apply the above example to clear the BGP connection to peer at IP address 192.0.2.11 for the VRF instance blue, use the following commands:

```
awplus# clear bgp 192.0.2.11 vrf blue in
```

Examples [BGP4+] awplus# clear bgp 2001:0db8:010d::1 soft in prefix-filter
awplus# clear bgp 2001:0db8:010d::1 out

Related commands [clear bgp \(IPv4 or IPv6 address\)](#)

Command changes Added to AlliedWare Plus prior to 5.4.6-1
Version 5.4.6-2.1: VRF-lite support added to BGP for AR-series products
Version 5.4.7-2.1: BGP support added for IEx510, x550 series
Version 5.4.7-2.4: BGP support added for IE300 series

clear bgp (ASN)

Overview Use this command to reset the BGP and BGP4+ connections for peers in the specified Autonomous System Number (ASN).

Syntax `clear bgp <asn> [in [prefix-filter]|out|soft [in|out]]`

Parameter	Description
<asn>	<1-4294967295> The AS Number for which all routes will be cleared.
in	Indicates that incoming advertised routes will be cleared.
prefix-filter	Specifies that a prefix-list will be sent, by the ORF mechanism, to those neighbors with which the ORF capability has been negotiated. The neighbors will be triggered to resend updates, which match the prefix-list filter, to the local router. The local router will then perform a soft reconfiguration.
out	Indicates that outgoing advertised routes will be cleared.
soft in	Soft inbound reset causes the neighbors to resend all their updates to the local device, without resetting the connection or clearing the entries in the local device. So, the local device stores new updates, and uses them to systematically replace existing table entries. This process can use a considerable amount of memory.
soft out	Soft outbound reset causes the device to simply resend all its updates to the specified neighbor(s), without resetting the connection, or clearing table entries.

Mode Privileged Exec

Examples

```
awplus# clear bgp 300 soft in prefix-filter
awplus# clear bgp 500 soft out
awplus# clear bgp 300 soft in
awplus# clear bgp 1 in prefix-filter
```

Command changes

- Added to AlliedWare Plus prior to 5.4.6-1
- Version 5.4.7-2.1: BGP support added for IEx510, x550 series
- Version 5.4.7-2.4: BGP support added for IE300 series

clear bgp external

Overview Use this command to reset the BGP and BGP4+ connections for all external peers.

Syntax `clear bgp external [in [prefix-filter]|out|soft [in|out]]`

Parameter	Description
external	Clears all external peers.
in	Indicates that incoming advertised routes will be cleared.
prefix-filter	Specifies that a prefix-list will be sent, by the ORF mechanism, to those neighbors with which the ORF capability has been negotiated. The neighbors will be triggered to resend updates, which match the prefix-list filter, to the local router. The local router will then perform a soft reconfiguration.
out	Indicates that outgoing advertised routes will be cleared.
soft in	Soft inbound reset causes the neighbors to resend all their updates to the local device, without resetting the connection or clearing the entries in the local device. So, the local device stores new updates, and uses them to systematically replace existing table entries. This process can use a considerable amount of memory.
soft out	Soft outbound reset causes the device to simply resend all its updates to the specified neighbor(s), without resetting the connection, or clearing table entries.

Mode Privileged Exec

Examples
`awplus# clear bgp external soft in`
`awplus# clear bgp external in prefix-filter`

Command changes
Added to AlliedWare Plus prior to 5.4.6-1
Version 5.4.7-2.1: BGP support added for IEx510, x550 series
Version 5.4.7-2.4: BGP support added for IE300 series

clear bgp peer-group

Overview Use this command to reset the BGP and BGP4+ connections for all members of a peer group.

Syntax `clear bgp peer-group <peer-group> [in [prefix-filter]|out|soft [in|out]]`

Parameter	Description
peer-group	Clears all members of a peer group.
<peer-group>	Name of the BGP peer group
in	Indicates that incoming advertised routes will be cleared.
prefix-filter	Specifies that a prefix-list will be sent, by the ORF mechanism, to those neighbors with which the ORF capability has been negotiated. The neighbors will be triggered to resend updates, which match the prefix-list filter, to the local router. The local router will then perform a soft reconfiguration.
out	Indicates that outgoing advertised routes will be cleared.
soft in	Soft inbound reset causes the neighbors to resend all their updates to the local device, without resetting the connection or clearing the entries in the local device. So, the local device stores new updates, and uses them to systematically replace existing table entries. This process can use a considerable amount of memory.
soft out	Soft outbound reset causes the device to simply resend all its updates to the specified neighbor(s), without resetting the connection, or clearing table entries.

Mode Privileged Exec

Examples
awplus# clear bgp peer-group P1 soft in
awplus# clear bgp peer-group P2 in

Command changes
Added to AlliedWare Plus prior to 5.4.6-1
Version 5.4.7-2.1: BGP support added for IEx510, x550 series
Version 5.4.7-2.4: BGP support added for IE300 series

clear bgp ipv6 (ipv6 address) (BGP4+ only)

Overview Use this command to reset the IPv6 BGP4+ connection to the peer specified by the IP address.

Syntax `clear bgp ipv6 <ipv6-addr> [in [prefix-filter]|out|soft [in|out]]`

Parameter	Description
<ipv6-addr>	Specifies the IPv6 address of the neighbor whose connection is to be reset, entered in hexadecimal in the format X:X::X:X.
ipv6	Clears all IPv6 address family peers. Configure parameters relating to the BGP4+ exchange of IPv6 prefixes.
in	Indicates that incoming advertised routes will be cleared.
prefix-filter	Specifies that a prefix-list will be sent, by the ORF mechanism, to those neighbors with which the ORF capability has been negotiated. The neighbors will be triggered to resend updates, which match the prefix-list filter, to the local router. The local router will then perform a soft reconfiguration.
out	Indicates that outgoing advertised routes will be cleared.
soft in	Soft inbound reset causes the neighbors to resend all their updates to the local device, without resetting the connection or clearing the entries in the local device. So, the local device stores new updates, and uses them to systematically replace existing table entries. This process can use a considerable amount of memory.
soft out	Soft outbound reset causes the device to simply resend all its updates to the specified neighbor(s), without resetting the connection, or clearing table entries.

Mode Privileged Exec

Examples Use the following command to clear the BGP4+ connection to peer at IPv6 address 2001:0db8:010d::1, and clearing all incoming routes.

```
awplus# clear ip bgp 2001:0db8:010d::1 in
```

Command changes Added to AlliedWare Plus prior to 5.4.6-1

Version 5.4.7-2.1: BGP support added for IEx510, x550 series

Version 5.4.7-2.4: BGP support added for IE300 series

clear bgp ipv6 dampening (BGP4+ only)

Overview Use this command to clear route dampening information and unsuppress routes that have been suppressed routes.

Syntax `clear bgp ipv6 dampening`
`[<ipv6-addr>|<ipv6-addr/prefix-length>]`

Parameter	Description
<code><ipv6-addr></code>	Specifies the IPv6 address for which BGP4+ dampening is to be cleared, entered in hexadecimal in the format X:X::X:X.
<code><ipv6-addr/prefix-length></code>	Specifies the IPv6 address and prefix-length for which BGP4+ dampening is to be cleared. The IPv6 address uses the format X:X::X:X/Prefix-Length. The prefix-length is usually set between 0 and 64.

Mode Privileged Exec

Examples `awplus# clear bgp ipv6 dampening 2001:0db8:010d::1`
`awplus# clear bgp ipv6 dampening 2001:0db8::/64`

Command changes Added to AlliedWare Plus prior to 5.4.6-1
Version 5.4.7-2.1: BGP support added for IEx510, x550 series
Version 5.4.7-2.4: BGP support added for IE300 series

clear bgp ipv6 flap-statistics (BGP4+ only)

Overview Use this command to clear the flap count and history duration for the specified prefixes.

Syntax `clear bgp ipv6 flap-statistics`
`[<ipv6-addr>|<ipv6-addr/prefix-length>]`

Parameter	Description
<code><ipv6-addr></code>	Specifies the IPv6 address for which BGP4+ flap count and history duration are to be cleared, entered in hexadecimal in the format X:X::X:X.
<code><ipv6-addr/prefix-length></code>	Specifies the IPv6 address with prefix length for which BGP4+ flap count and history duration are to be cleared. The IPv6 address uses the format X:X::X:X/Prefix-Length. The prefix-length is usually set between 0 and 64.

Mode Privileged Exec

Examples `awplus# clear bgp ipv6 flap-statistics 2001:0db8:010d::1`
`awplus# clear bgp ipv6 flap-statistics 2001:0db8::/64`

Command changes Added to AlliedWare Plus prior to 5.4.6-1
Version 5.4.7-2.1: BGP support added for IEx510, x550 series
Version 5.4.7-2.4: BGP support added for IE300 series

clear bgp ipv6 (ASN) (BGP4+ only)

Overview Use this command to reset the BGP4+ connections to all peers in a specified Autonomous System Number (ASN).

Syntax

```
clear bgp ipv6 <asn> [in [prefix-filter]|out|soft [in|out]]
clear bgp ipv6 <asn>
clear bgp ipv6 <asn> in [prefix-filter]
clear bgp ipv6 <asn> out
clear bgp ipv6 <asn> soft [in|out]
```

Parameter	Description
<asn>	<1-4294967295> Specifies the ASN for which all routes will be cleared.
in	Indicates that incoming advertised routes will be cleared.
prefix-filter	Specifies that a prefix-list will be sent, by the ORF mechanism, to those neighbors with which the ORF capability has been negotiated. The neighbors will be triggered to resend updates, which match the prefix-list filter, to the local router. The local router will then perform a soft reconfiguration.
out	Indicates that outgoing advertised routes will be cleared.
soft in	Soft inbound reset causes the neighbors to resend all their updates to the local device, without resetting the connection or clearing the entries in the local device. So, the local device stores new updates, and uses them to systematically replace existing table entries. This process can use a considerable amount of memory.
soft out	Soft outbound reset causes the device to simply resend all its updates to the specified neighbor(s), without resetting the connection, or clearing table entries.

Mode Privileged Exec

Examples

```
awplus# clear bgp ipv6 100
awplus# clear bgp ipv6 100 in
awplus# clear bgp ipv6 100 in prefix-filter
awplus# clear bgp ipv6 100 out
awplus# clear bgp ipv6 100 soft out
awplus# clear bgp ipv6 100 soft in
```

Command changes

- Added to AlliedWare Plus prior to 5.4.6-1
- Version 5.4.7-2.1: BGP support added for IEx510, x550 series
- Version 5.4.7-2.4: BGP support added for IE300 series

clear bgp ipv6 external (BGP4+ only)

Overview Use this command to reset the BGP4+ connections to all external peers.

Syntax

```
clear bgp ipv6 external [in [prefix-filter]|out|soft [in|out]]
clear bgp ipv6 external
clear bgp ipv6 external in [prefix-filter]
clear bgp ipv6 external out
clear bgp ipv6 external soft [in|out]
```

Parameter	Description
external	Clears all external peers.
in	Indicates that incoming advertised routes will be cleared.
prefix-filter	Specifies that a prefix-list will be sent, by the ORF mechanism, to those neighbors with which the ORF capability has been negotiated. The neighbors will be triggered to resend updates, which match the prefix-list filter, to the local router. The local router will then perform a soft reconfiguration.
out	Indicates that outgoing advertised routes will be cleared.
soft in	Soft inbound reset causes the neighbors to resend all their updates to the local device, without resetting the connection or clearing the entries in the local device. So, the local device stores new updates, and uses them to systematically replace existing table entries. This process can use a considerable amount of memory.
soft out	Soft outbound reset causes the device to simply resend all its updates to the specified neighbor(s), without resetting the connection, or clearing table entries.

Mode Privileged Exec

Examples

```
awplus# clear bgp ipv6 external in
awplus# clear bgp ipv6 external in prefix
awplus# clear bgp ipv6 external out
awplus# clear bgp ipv6 external soft out
awplus# clear bgp ipv6 external soft in
```

Command changes

- Added to AlliedWare Plus prior to 5.4.6-1
- Version 5.4.7-2.1: BGP support added for IEx510, x550 series
- Version 5.4.7-2.4: BGP support added for IE300 series

clear bgp ipv6 peer-group (BGP4+ only)

Overview Use this command to reset the BGP4+ connections to all members of a peer group.

Syntax

```
clear bgp ipv6 peer-group <peer-name>  
clear bgp ipv6 peer-group <peer-name> in [prefix-filter]  
clear bgp ipv6 peer-group <peer-name> out  
clear bgp ipv6 peer-group <peer-name> soft [in|out]
```

Parameter	Description
peer-group	Clears all members of a peer group.
<peer-name>	Specifies the name of the peer group for which all members will be cleared.
ipv6	Clears all IPv6 address family peers. Configure parameters relating to the BGP4+ exchange of IPv6 prefixes.
in	Indicates that incoming advertised routes will be cleared.
prefix-filter	Specifies that a prefix-list will be sent, by the ORF mechanism, to those neighbors with which the ORF capability has been negotiated. The neighbors will be triggered to resend updates, which match the prefix-list filter, to the local router. The local router will then perform a soft reconfiguration.
out	Indicates that outgoing advertised routes will be cleared.
soft in	Soft inbound reset causes the neighbors to resend all their updates to the local device, without resetting the connection or clearing the entries in the local device. So, the local device stores new updates, and uses them to systematically replace existing table entries. This process can use a considerable amount of memory.
soft out	Soft outbound reset causes the device to simply resend all its updates to the specified neighbor(s), without resetting the connection, or clearing table entries.

Mode Privileged Exec

Example awplus# clear bgp ipv6 peer-group Peer1 out

Command changes

- Added to AlliedWare Plus prior to 5.4.6-1
- Version 5.4.7-2.1: BGP support added for IEx510, x550 series
- Version 5.4.7-2.4: BGP support added for IE300 series

clear ip bgp * (BGP only)

Overview Use this command to reset all BGP connections, either by fully resetting sessions or by performing soft resets.

If VRF-lite is configured, you can reset BGP connections for all VRF instances or for a specified VRF instance.

Syntax

```
clear ip bgp *  
clear ip bgp * in  
clear ip bgp * out  
clear ip bgp * soft [in|out]  
clear ip bgp * in [prefix-filter]
```

Syntax (VRF-lite)

```
clear ip bgp * [vrf <vrf-name>]  
clear ip bgp * [vrf <vrf-name>] in  
clear ip bgp * [vrf <vrf-name>] out  
clear ip bgp * [vrf <vrf-name>] soft [in|out]  
clear ip bgp * in [prefix-filter]
```

Parameter	Description
*	Clears all BGP peers.
in	Indicates that incoming advertised routes will be cleared.
prefix-filter	Specifies that a prefix-list will be sent, by the ORF mechanism, to those neighbors with which the ORF capability has been negotiated. The neighbors will be triggered to resend updates, which match the prefix-list filter, to the local router. The local router will then perform a soft reconfiguration.
out	Indicates that outgoing advertised routes will be cleared.
soft in	Soft inbound reset causes the neighbors to resend all their updates to the local device, without resetting the connection or clearing the entries in the local device. So, the local device stores new updates, and uses them to systematically replace existing table entries. This process can use a considerable amount of memory.
soft out	Soft outbound reset causes the device to simply resend all its updates to the specified neighbor(s), without resetting the connection, or clearing table entries.
vrf	Applies the command to the specified VRF instance.
<vrf-name>	The name of the VRF instance.

Mode Privileged Exec

Examples To clear all BGP peers, use the command:

```
awplus# clear ip bgp *
```

Example (VRF-lite) To clear all BGP peers in VRF instance red, use the command:

```
awplus# clear ip bgp * vrf red
```

To clear all outbound BGP peers in VRF instance red, use the command:

```
awplus# clear ip bgp * out vrf red
```

Command changes Added to AlliedWare Plus prior to 5.4.6-1

Version 5.4.6-2.1: VRF-lite support added to BGP for AR-series products

Version 5.4.7-2.1: BGP support added for IEx510, x550 series

Version 5.4.7-2.4: BGP support added for IE300 series

clear ip bgp (IPv4) (BGP only)

Overview Use this command to reset the IPv4 BGP connection to the peer specified by the IP address. When VRF-lite is configured, you can apply this command to a specific VRF instance.

Syntax [BGP] `clear ip bgp <ipv4-addr> [in [prefix-filter]|out|soft [in|out]]`

Syntax (VRF-lite) `clear ip bgp <ipv4-address> [vrf <vrf-name>] [in|out|soft [in|out]]`

Parameter	Description
<ipv4-addr>	Specifies the IPv4 address of the neighbor whose connection is to be reset, entered in the form A.B.C.D.
in	Indicates that incoming advertised routes will be cleared.
prefix-filter	Specifies that a prefix-list will be sent, by the ORF mechanism, to those neighbors with which the ORF capability has been negotiated. The neighbors will be triggered to resend updates, which match the prefix-list filter, to the local router. The local router will then perform a soft reconfiguration.
out	Indicates that outgoing advertised routes will be cleared.
soft in	Soft inbound reset causes the neighbors to resend all their updates to the local switch, without resetting the connection or clearing the entries in the local switch. So, the local switch stores new updates, and uses them to systematically replace existing table entries. This process can use a considerable amount of memory.
soft out	Soft outbound reset causes the switch to simply resend all its updates to the specified neighbor(s), without resetting the connection, or clearing table entries.
vrf	Applies the command to the specified VRF instance.
<vrf-name>	The name of the VRF instance.

Mode [BGP] Privileged Exec

Examples [BGP] To clear the BGP connection to the peer at IPv4 address 192.168.1.1 and clear all incoming routes, use the following command:

```
awplus# clear ip bgp 192.168.1.1 in
```

To apply the above example to clear the BGP connection to the peer at IP address 192.0.2.11 for the VRF instance blue, use the following commands:

```
awplus# clear ip bgp 192.0.2.11 vrf blue in
```

Command changes Added to AlliedWare Plus prior to 5.4.6-1
Version 5.4.6-2.1: VRF-lite support added to BGP for AR-series products

Version 5.4.7-2.1: BGP support added for IEx510, x550 series

Version 5.4.7-2.4: BGP support added for IE300 series

clear ip bgp dampening (BGP only)

Overview Use this command to clear route dampening information and unsuppress routes that have been suppressed.

Syntax `clear ip bgp dampening [<ip-address>|<ip-address/m>]`

Parameter	Description
<code><ip-address></code>	Specifies the IPv4 address for which BGP dampening is to be cleared, in dotted decimal format.
<code><ip-address/m></code>	Specifies the IPv4 address with mask for which BGP dampening is to be cleared, entered in the form A.B.C.D/M. Where M is the subnet mask
<code>ipv4</code>	Clears all IPv4 address family peers. Configure parameters relating to the BGP exchange of IPv4 prefixes.

Mode Privileged Exec

Examples `awplus# clear ip bgp dampening 10.10.0.121`

Command changes Added to AlliedWare Plus prior to 5.4.6-1
Version 5.4.7-2.1: BGP support added for IEx510, x550 series
Version 5.4.7-2.4: BGP support added for IE300 series

clear ip bgp flap-statistics (BGP only)

Overview Use this command to clear the flap count and history duration for the specified prefixes.

Syntax `clear ip bgp flap-statistics [<ip-address>|<ip-address/m>]`

Parameter	Description
<code><ip-address></code>	Specifies the IPv4 address for which BGP flap count and history duration are to be cleared.
<code><ip-address/m></code>	Specifies the IPv4 address with mask for which BGP flap count and history duration are to be cleared.
<code>ipv4</code>	Clears all IPv4 address family peers. Configure parameters relating to the BGP exchange of IPv4 prefixes.

Mode Privileged Exec

Examples `awplus# clear ip bgp flap-statistics 10.10.0.121`

Command changes Added to AlliedWare Plus prior to 5.4.6-1
Version 5.4.7-2.1: BGP support added for IEx510, x550 series
Version 5.4.7-2.4: BGP support added for IE300 series

clear ip bgp (ASN) (BGP only)

Overview Use this command to reset the BGP connections to all peers in a specified Autonomous System Number (ASN).

Syntax

```
clear ip bgp <asn> [in [prefix-filter]|out|soft [in|out]]
clear ip bgp <asn> ipv4
clear ip bgp <asn> ipv4 in [prefix-filter]
clear ip bgp <asn> ipv4 out
clear ip bgp <asn> ipv4 soft [in|out]
```

Parameter	Description
<asn>	<1-4294967295> Specifies the ASN for which all routes will be cleared.
ipv4	Clears all IPv4 address family peers. Configure parameters relating to the BGP exchange of IPv4 prefixes.
in	Indicates that incoming advertised routes will be cleared.
prefix-filter	Specifies that a prefix-list will be sent, by the ORF mechanism, to those neighbors with which the ORF capability has been negotiated. The neighbors will be triggered to resend updates, which match the prefix-list filter, to the local router. The local router will then perform a soft reconfiguration.
out	Indicates that outgoing advertised routes will be cleared.
soft in	Soft inbound reset causes the neighbors to resend all their updates to the local device, without resetting the connection or clearing the entries in the local device. So, the local device stores new updates, and uses them to systematically replace existing table entries. This process can use a considerable amount of memory.
soft out	Soft outbound reset causes the device to simply resend all its updates to the specified neighbor(s), without resetting the connection, or clearing table entries.

Mode Privileged Exec

Examples awplus# clear ip bgp 100

Command changes

- Added to AlliedWare Plus prior to 5.4.6-1
- Version 5.4.7-2.1: BGP support added for IEx510, x550 series
- Version 5.4.7-2.4: BGP support added for IE300 series

clear ip bgp external (BGP only)

Overview Use this command to reset the BGP connections to all external peers.

Syntax

```
clear ip bgp external [in [prefix-filter]|out|soft [in|out]]
clear ip bgp external
clear ip bgp external in [prefix-filter]
clear ip bgp external out
clear ip bgp external soft [in|out]
```

Parameter	Description
external	Clears all external peers.
ipv4	Clears all IPv4 address family peers. Configure parameters relating to the BGP exchange of IPv4 prefixes.
in	Indicates that incoming advertised routes will be cleared.
prefix-filter	Specifies that a prefix-list will be sent, by the ORF mechanism, to those neighbors with which the ORF capability has been negotiated. The neighbors will be triggered to resend updates, which match the prefix-list filter, to the local router. The local router will then perform a soft reconfiguration.
out	Indicates that outgoing advertised routes will be cleared.
soft in	Soft inbound reset causes the neighbors to resend all their updates to the local device, without resetting the connection or clearing the entries in the local device. So, the local device stores new updates, and uses them to systematically replace existing table entries. This process can use a considerable amount of memory.
soft out	Soft outbound reset causes the device to simply resend all its updates to the specified neighbor(s), without resetting the connection, or clearing table entries.

Mode Privileged Exec

Examples awplus# clear ip bgp external out

Command changes

- Added to AlliedWare Plus prior to 5.4.6-1
- Version 5.4.7-2.1: BGP support added for IEx510, x550 series
- Version 5.4.7-2.4: BGP support added for IE300 series

clear ip bgp peer-group (BGP only)

Overview Use this command to reset the BGP connections to all members of a peer group.

Syntax

```
clear ip bgp peer-group <peer-name>
clear ip bgp peer-group <peer-name> in [prefix-filter]
clear ip bgp peer-group <peer-name> out
clear ip bgp peer-group <peer-name> soft [in|out]
clear ip bgp peer-group <peer-name> out
clear ip bgp peer-group <peer-name> soft [in|out]
```

Parameter	Description
peer-group	Clears all members of a peer group.
<peer-name>	Specifies the name of the peer group for which all members will be cleared.
ipv4	Clears all IPv4 address family peers. Configure parameters relating to the BGP exchange of IPv4 prefixes.
in	Indicates that incoming advertised routes will be cleared.
prefix-filter	Specifies that a prefix-list will be sent, by the ORF mechanism, to those neighbors with which the ORF capability has been negotiated. The neighbors will be triggered to resend updates, which match the prefix-list filter, to the local router. The local router will then perform a soft reconfiguration.
out	Indicates that outgoing advertised routes will be cleared.
soft in	Soft inbound reset causes the neighbors to resend all their updates to the local device, without resetting the connection or clearing the entries in the local device. So, the local device stores new updates, and uses them to systematically replace existing table entries. This process can use a considerable amount of memory.
soft out	Soft outbound reset causes the device to simply resend all its updates to the specified neighbor(s), without resetting the connection, or clearing table entries.

Mode Privileged Exec

Examples awplus# clear ip bgp peer-group Peer1 out

Command changes

- Added to AlliedWare Plus prior to 5.4.6-1
- Version 5.4.7-2.1: BGP support added for IEx510, x550 series
- Version 5.4.7-2.4: BGP support added for IE300 series

clear ip prefix-list

Overview Use this command to reset the hit count to zero in the prefix-list entries.

Syntax `clear ip prefix-list [<list-name>] [<ip-address>/<mask>]`

Parameter	Description
<list-name>	The name of the prefix-list.
<ip-address>/<mask>	The IP prefix and length.

Mode Privileged Exec

Example To clear a prefix-list named List1:

```
awplus# clear ip prefix-list List1
```

debug bgp (BGP only)

Overview Use this command to turn on one or more BGP debug options.

Use the **no** variant of this command to disable one or more BGP debug options.

Syntax

```
debug bgp  
[all|dampening|events|filters|fsm|keepalives|nht|nsm|updates  
[in|out]]  
  
no debug all bgp  
  
no debug bgp  
[all|dampening|events|filters|fsm|keepalives|nht|nsm|updates  
[in|out]]
```

Parameter	Description
all	Turns on all debugging for BGP.
dampening	Specifies debugging for BGP dampening.
events	Specifies debugging for BGP events.
filters	Specifies debugging for BGP filters.
fsm	Specifies debugging for BGP Finite State Machine (FSM).
keepalives	Specifies debugging for BGP keepalives.
nht	Specifies debugging for BGP NHT (Next Hop Tracking) messages.
nsm	Specifies debugging for NSM messages.
updates	[in out] Specifies debugging for BGP updates.
in	Inbound updates.
out	Outbound updates.

Mode Privileged Exec and Global Configuration

Usage If the command is entered with no parameters, then all debug options are enabled.

Examples

```
awplus# debug bgp  
awplus# debug bgp events  
awplus# debug bgp nht  
awplus# debug bgp updates in
```

Related commands [show debugging bgp \(BGP only\)](#)
[undebug bgp \(BGP only\)](#)

Command changes Added to AlliedWare Plus prior to 5.4.6-1

Version 5.4.7-2.1: BGP support added for IEx510, x550 series

Version 5.4.7-2.4: BGP support added for IE300 series

distance (BGP and BGP4+)

Overview This command sets the administrative distance for BGP and BGP4+ routes. The device uses this value to select between two or more routes to the same destination from two different routing protocols. Set the administrative distance for BGP routes in the Router Configuration mode, and for BGP4+ routes in IPv6 Address Family Configuration mode.

The route with the smallest administrative distance value is added to the Forwarding Information Base (FIB). For more information, see the [Route Selection Feature Overview and Configuration Guide](#), which is available from the above link at [alliedtelesis.com](#).

The **no** variant of this command sets the administrative distance for the route to the default for the route type.

Syntax

```
distance <1-255> <ip-address/m>
distance bgp <ebgp> <ibgp> <local>
no distance <1-255> <ip-address/m>
no distance bgp <ebgp> <ibgp> <local>
```

Parameter	Description
<1-255>	The administrative distance value you are setting for the route.
<ip-address/m>	The IP source prefix that you are changing the administrative distance for, entered in the form A . B . C . D / M. This is an IPv4 address in dotted decimal notation followed by a forward slash, and then the prefix length.
<ebgp>	Specifies the administrative distance of external BGP (eBGP) routes. These are routes learned from a neighbor out of the AS. Specify the distance as a number between 1 and 255. Default: 20
<ibgp>	Specifies the administrative distance of internal BGP (iBGP) routes. These are routes learned from a neighbor within the same AS. Specify the distance as a number between 1 and 255. Default: 200
<local>	Specifies the administrative distance of local BGP routes. These are routes redistributed from another protocol within your device. Specify the distance as a number between 1 and 255. Default: 200

Mode [BGP] Router Configuration

Mode [BGP4+] IPv6 Address Family Configuration

Usage notes You can use this command to set the administrative distance:

- for each BGP route type by specifying:

```
awplus(config-router)# distance <ebgp> <igbp> <local>
```

- for a specific route by specifying:

```
awplus(config-router)# distance <1-255> <ip-address/m>  
[<listname>]
```

If the administrative distance is changed, it could create inconsistency in the routing table and obstruct routing.

Example [BGP4+] For BGP4+ IPv6, to set BGP 100's administrative distances for eBGP routes to 34, iBGP routes to 23, and local BGP routes to 15, use the commands:

```
awplus# configure terminal  
awplus(config)# router bgp 100  
awplus(config-router)# address-family ipv6  
awplus(config-router-af)# distance bgp 34 23 15
```

**Command
changes**

Added to AlliedWare Plus prior to 5.4.6-1

Version 5.4.7-2.1: BGP support added for IEx510, x550 series

Version 5.4.7-2.4: BGP support added for IE300 series

exit-address-family

Overview Use this command to exit either the IPv4 or the IPv6 Address Family Configuration mode.

Syntax `exit-address-family`

Mode [BGP] IPv4 Address Family Configuration

Mode [BGP4+] IPv6 Address Family Configuration

Examples [BGP] To enter and then exit IPv4 Address Family Configuration mode, use the commands:

```
awplus# configure terminal
awplus(config)# router bgp 100
awplus(config-router)# address-family ipv4
awplus(config-router-af)# exit-address-family
awplus(config-router)#
```

Example (VRF-lite) To enter and then exit IPv4 Address Family Configuration mode for VRF instance red, use the commands:

```
awplus# configure terminal
awplus(config)# router bgp 100
awplus(config-router)# address-family ipv4 vrf red
awplus(config-router-af)# exit-address-family
awplus(config-router)#
```

Example [BGP4+] To enter and then exit IPv6 Address Family Configuration mode, use the commands:

```
awplus# configure terminal
awplus(config)# router bgp 100
awplus(config-router)# address-family ipv6
awplus(config-router-af)# exit-address-family
awplus(config-router)#
```

Related commands [address-family](#)

Command changes

- Added to AlliedWare Plus prior to 5.4.6-1
- Version 5.4.6-2.1: VRF-lite support added to BGP for AR-series products
- Version 5.4.7-2.1: BGP support added for IEx510, x550 series
- Version 5.4.7-2.4: BGP support added for IE300 series

ip community-list

Overview Use this command to add an entry to a standard or extended BGP community-list filter.

Use the **no** variant of this command to delete a standard or extended community list entry.

Syntax `ip community-list <listname> {deny|permit} .<community>`
`no ip community-list <listname> {deny|permit} .<community>`

Parameter	Description
<listname>	Specifies the community listname.
deny	Specifies the community to reject.
permit	Specifies the community to accept.
.<community>	{<AS:VAL> local-AS no-advertise no-export}
<AS:VAL>	Specifies the valid value for the community number. This format represents the 32 bit communities value, where AS is the high order 16 bits and VAL is the low order 16 bits in digit format.
local-AS	Specifies routes not to be advertised to external BGP peers.
no-advertise	Specifies routes not to be advertised to other BGP peers.
no-export	Specifies routes not to be advertised outside of Autonomous System boundary.

Mode Global Configuration

Usage notes A community-list can be used as a filter to BGP updates. Use this command to define the community access list globally, then use neighbor configuration commands to apply the list to a particular neighbor.

There are two kinds of community-lists: expanded and standard. A standard community-list defines the community attributes explicitly and not via a regular expression. An expanded community-list defines the communities attributes with regular expressions.

The standard community-list is compiled into binary format and is directly compared with the BGP communities attribute in the BGP updates. The comparison is faster than the expanded community-list. Any community value that does not match the standard community value is automatically treated as expanded.

Example `awplus# configure terminal`
`awplus(config)# ip community-list mylist permit 7675:80 7675:90`

Related commands [ip community-list standard](#)
[ip community-list expanded](#)
[show ip community-list](#)

Command changes Added to AlliedWare Plus prior to 5.4.6-1
Version 5.4.7-2.1: BGP support added for IEx510, x550 series
Version 5.4.7-2.4: BGP support added for IE300 series

ip community-list expanded

Overview Use this command to add an entry to an expanded BGP community-list filter.

Use the **no** variant of this command to delete the community list entry.

Syntax

```
ip community-list <100-199> {deny|permit} .<line>  
no ip community-list <100-199> {deny|permit} .<line>  
ip community-list expanded <expanded-listname> {deny|permit}  
.<line>  
no ip community-list expanded <expanded-listname> {deny|permit}  
.<line>
```

Parameter	Description
<100-199>	Expanded community list number.
expanded	Specifies an expanded community list.
<expanded-listname>	Expanded community list entry.
deny	Specifies community to reject.
permit	Specifies community to accept.
.<line>	Specifies community attributes with regular expressions.

Regular expressions listed below can be used with the **ip community-list expanded** command:

Symbol	Character	Meaning
^	Caret	Used to match the beginning of the input string. When used at the beginning of a string of characters, it negates a pattern match.
\$	Dollar sign	Used to match the end of the input string.
.	Period	Used to match a single character (white spaces included).
*	Asterisk	Used to match none or more sequences of a pattern.
+	Plus sign	Used to match one or more sequences of a pattern.
?	Question mark	Used to match none or one occurrence of a pattern.
_	Underscore	Used to match spaces, commas, braces, parenthesis, or the beginning and end of an input string.
[]	Brackets	Specifies a range of single-characters.
-	Hyphen	Separates the end points of a range.

Mode Global Configuration

Usage notes A `community-list` can be used as a filter to BGP updates. Use this command to define the community access list globally, then use **neighbor** configuration commands to apply the list to a particular neighbor.

There are two kinds of community-lists: expanded and standard. A standard community-list defines the community attributes explicitly and not via a regular expression. An expanded community-list defines the communities attributes with regular expressions.

The standard community-list is compiled into binary format and is directly compared with the BGP communities attribute in the BGP updates. The comparison is faster than the expanded community-list. Any community value that does not match the standard community value is automatically treated as expanded.

Examples

```
awplus# configure terminal
awplus(config)# ip community-list 125 permit 6789906
awplus(config)# ip community-list expanded CLIST permit .*
```

Related commands

- [ip community-list](#)
- [ip community-list standard](#)
- [show ip community-list](#)

Command changes

- Added to AlliedWare Plus prior to 5.4.6-1
- Version 5.4.7-2.1: BGP support added for IEx510, x550 series
- Version 5.4.7-2.4: BGP support added for IE300 series

ip community-list standard

Overview Use this command to add an entry to a standard BGP community-list filter.
Use the **no** variant of this command to delete the standard community-list entry.

Syntax

```
ip community-list <1-99> {deny|permit} [.<community>]  
no ip community-list <1-99> {deny|permit} [.<community>]  
ip community-list standard <standard-listname> {deny|permit}  
[.<community>]  
no ip community-list standard <standard-listname> {deny|permit}  
[.<community>]
```

Parameter	Description
<1-99>	Standard community list number.
standard	Specifies a standard community list.
<standard-listname>	Standard community list entry.
deny	Specifies community to reject.
permit	Specifies community to accept.
<community>	{<AS:VAL> local-AS no-advertise no-export}
<AS:VAL>	Specifies the valid value for the community number. This format represents the 32 bit communities value, where AS is the high order 16 bits and VAL is the low order 16 bits in digit format.
local-AS	Specifies routes not to be advertised to external BGP peers.
no-advertise	Specifies routes not to be advertised to other BGP peers.
no-export	Specifies routes not to be advertised outside of the Autonomous System boundary.

Mode Global Configuration

Usage notes A community-list can be used as a filter to BGP updates. Use this command to define the community access list globally, then use neighbor configuration commands to apply the list to a particular neighbor.

There are two kinds of community-lists: expanded and standard. The standard community-list defines the community attributes as explicit values, without regular expressions. The expanded community-list defines the communities attributes with regular expressions.

The standard community-list is compiled into binary format and is directly compared with the BGP communities attribute in the BGP updates. The comparison is faster than the expanded community-list. Any community value

that does not match the standard community value is automatically treated as expanded.

Examples

```
awplus# configure terminal
awplus(config)# ip community-list standard CLIST permit 7675:80
7675:90 no-export
awplus(config)# ip community-list 34 permit 5675:50
no-advertise
```

Related commands

- [ip community-list](#)
- [ip community-list expanded](#)
- [show ip community-list](#)

Command changes

- Added to AlliedWare Plus prior to 5.4.6-1
- Version 5.4.7-2.1: BGP support added for IEx510, x550 series
- Version 5.4.7-2.4: BGP support added for IE300 series

ip extcommunity-list expanded

Overview Use this command to create or delete an expanded extended community list.

Use the **no** variant of this command to delete the expanded extended community-list entry.

Syntax

```
ip extcommunity-list <100-199> {deny|permit}
{.<line>|.<AS:NN>|.<ip-address>}

no ip extcommunity-list <100-199> {deny|permit}
{.<line>|.<AS:NN>|.<ip-address>}

ip extcommunity-list expanded <expanded-listname> {deny|permit}
{.<line>|.<AS:NN>|.<ip-address>}

no ip extcommunity-list expanded <expanded-listname>
{deny|permit} {.<line>|.<AS:NN>|.<ip-address>}

no ip extcommunity-list <100-199>

no ip extcommunity-list expanded <expanded-listname>
```

Parameter	Description
<100-199>	Expanded extcommunity list number.
expanded	Specifies an expanded extcommunity list.
<expanded-listname>	Expanded extcommunity list entry.
deny	Specifies the extcommunity to reject.
permit	Specifies the extcommunity to accept.
.<line>	Specifies extcommunity attributes with regular expression.
<AS:NN>	Specifies the valid value for an extcommunity number. This format represents the 32 bit extcommunities value, where AA is the high order 16 bits and NN is the low order 16 bits in digit format.
<ip-address>	Specifies the IP address to deny or permit.

Regular expressions listed below are used with the **ip extcommunity-list expanded** command:

Symbol	Character	Meaning
^	Caret	Used to match the beginning of the input string. When used at the beginning of a string of characters, it negates a pattern match.
\$	Dollar sign	Used to match the end of the input string.

Symbol	Character	Meaning
.	Period	Used to match a single character (white spaces included).
*	Asterisk	Used to match none or more sequences of a pattern.
+	Plus sign	Used to match one or more sequences of a pattern.
?	Question mark	Used to match none or one occurrence of a pattern.
_	Underscore	Used to match spaces, commas, braces, parenthesis, or the beginning and end of an input string.
[]	Brackets	Specifies a range of single-characters.
-	Hyphen	Separates the end points of a range.

Mode Global Configuration

Examples

```
awplus# configure terminal
awplus(config)# ip extcommunity-list 125 permit 4567335
awplus(config)# ip extcommunity-list expanded CLIST permit .*
```

Related commands [ip extcommunity-list standard](#)
[show ip extcommunity-list](#)

Command changes Added to AlliedWare Plus prior to 5.4.6-1
Version 5.4.7-2.1: BGP support added for IEx510, x550 series
Version 5.4.7-2.4: BGP support added for IE300 series

ip extcommunity-list standard

Overview Use this command to create and delete a standard extended community list.

Use the **no** variant of this command to delete a standard extended community-list entry.

Syntax

```
ip extcommunity-list <1-99> {deny|permit} {rt|soo}
<community-number>

ip extcommunity-list standard <standard-listname> {deny|permit}
{rt|soo} <community-number>

no ip extcommunity-list <1-99> [{deny|permit} {rt|soo}
<community-number>]

no ip extcommunity-list standard <standard-listname>
[deny|permit} {rt|soo} <community-number>]
```

Parameter	Description
<1-99>	Standard extcommunity list number.
standard	Specifies a standard extended community list.
<standard-listname>	Standard extended community list entry.
deny	Specifies the extended community to reject.
permit	Specifies the extended community to accept.
rt	Specifies the route target of the extended community.
soo	Specifies the site of origin of the extended community.
<community-number>	Specifies the valid value for an extended community number. This can be one of two formats: <ul style="list-style-type: none">• <ASN:NN> where ASN is an AS (Autonomous System) number and NN is a value chosen by the ASN administrator• <A.B.C.D:NN> where A.B.C.D is an IPv4 address, and NN is a value chosen by the ASN administrator. Note that ASN and NN are both integers from 1 to 4294967295. AS numbers are assigned to the regional registries by IANA (www.iana.org) and must be obtained in your region.

Mode Global Configuration

Examples

```
awplus# configure terminal
awplus(config)# ip extcommunity-list 36 permit rt 5675:50
awplus(config)# ip extcommunity-list standard CLIST permit soo
7645:70
awplus# configure terminal
awplus(config)# ip extcommunity-list 36 deny rt 192.168.1.1:70
awplus(config)# ip extcommunity-list standard CLIST deny soo
10.10.1.1:50
```

Related commands

- [ip extcommunity-list expanded](#)
- [show ip extcommunity-list](#)

Command changes

- Added to AlliedWare Plus prior to 5.4.6-1
- Version 5.4.7-2.1: BGP support added for IEx510, x550 series
- Version 5.4.7-2.4: BGP support added for IE300 series

ip prefix-list

Overview Use this command to create an entry for an IPv4 prefix list.

Use the **no** variant of this command to delete the IPv4 prefix-list entry.

Syntax

```
ip prefix-list <list-name> [seq <1-429496725>] {deny|permit}
{any|<ip-prefix>} [ge <0-32>] [le <0-32>]

ip prefix-list <list-name> description <text>

ip prefix-list sequence-number

no ip prefix-list <list-name> [seq <1-429496725>]

no ip prefix-list <list-name> [description <text>]

no ip prefix-list sequence-number
```

Parameter	Description
<list-name>	Specifies the name of a prefix list.
seq <1-429496725>	Sequence number of the prefix list entry.
deny	Specifies that the prefixes are excluded from the list.
permit	Specifies that the prefixes are included in the list.
<ip-prefix>	Specifies the IPv4 address and length of the network mask in dotted decimal in the format A.B.C.D/M.
any	Any prefix match. Same as 0.0.0.0 le 32 .
ge<0-32>	Specifies the minimum prefix length to be matched.
le<0-32>	Specifies the maximum prefix length to be matched.
<text>	Text description of the prefix list.
sequence-number	Specify sequence numbers included or excluded in prefix list.

Mode Global Configuration

Usage notes When the device processes a prefix list, it starts to match prefixes from the top of the prefix list, and stops whenever a permit or deny occurs. To promote efficiency, use the **seq** parameter and place common permits or denials towards the top of the list. If you do not use the **seq** parameter, the sequence values are generated in a sequence of 5.

The parameters **ge** and **le** specify the range of the prefix lengths to be matched. When setting these parameters, set the **le** value to be less than 32, and the **ge** value to be less than or equal to the **le** value and greater than the ip-prefix mask length.

Prefix lists implicitly exclude prefixes that are not explicitly permitted in the prefix list. This means if a prefix that is being checked against the prefix list reaches the end of the prefix list without matching a permit or deny, this prefix will be denied.

Example In the following sample configuration, the last **ip prefix-list** command in the below list matches all, and the first **ip prefix-list** command denies the IP network 76.2.2.0:

```
awplus(config)# router bgp 100
awplus(config-router)# network 172.1.1.0
awplus(config-router)# network 172.1.2.0
awplus(config-router)# neighbor 10.6.5.3 remote-as 300
awplus(config-router)# neighbor 10.6.5.3 prefix-list mylist out
awplus(config-router)# exit
awplus(config)# ip prefix-list mylist seq 5 deny 76.2.2.0/24
awplus(config)# ip prefix-list mylist seq 100 permit any
```

To deny the IP addresses between 10.0.0.0/14 (10.0.0.0 255.252.0.0) and 10.0.0.0/22 (10.0.0.0 255.255.252.0) within the 10.0.0.0/8 (10.0.0.0 255.0.0.0) addressing range, enter the following commands:

```
awplus# configure terminal
awplus(config)# ip prefix-list mylist seq 12345 deny 10.0.0.0/8
ge 14 le 22
```

Related commands

- [neighbor prefix-list](#)
- [clear ip prefix-list](#)
- [show ip prefix-list](#)

ipv6 prefix-list

Overview Use this command to create an IPv6 prefix list or an entry in an existing prefix list.

Use the **no** variant of this command to delete a whole prefix list, a prefix list entry, or a description.

Syntax

```
ipv6 prefix-list <list-name> [seq <1-429496725>] {deny|permit}
{any|<ipv6-prefix>} [ge <0-128>] [le <0-128>]
ipv6 prefix-list <list-name> description <text>
no ipv6 prefix-list <list-name> [seq <1-429496725>]
no ipv6 prefix-list <list-name> [description <text>]
```

Parameter	Description
<list-name>	Specifies the name of a prefix list.
seq <1-429496725>	Sequence number of the prefix list entry.
deny	Specifies that the prefixes are excluded from the list.
permit	Specifies that the prefixes are included in the list.
<ipv6-prefix>	Specifies the IPv6 prefix and prefix length in hexadecimal in the format X:X::X:X/M.
any	Any prefix match. Same as ::0/0 le 128.
ge <0-128>	Specifies the minimum prefix length to be matched.
le <0-128>	Specifies the maximum prefix length to be matched.
description	Prefix list specific description.
<text>	Up to 80 characters of text description of the prefix list.

Mode Global Configuration

Usage notes When the device processes a prefix list, it starts to match prefixes from the top of the prefix list, and stops whenever a permit or deny occurs. To promote efficiency, use the **seq** parameter and place common permits or denials towards the top of the list. If you do not use the **seq** parameter, the sequence values are generated in a sequence of 5.

The parameters **ge** and **le** specify the range of the prefix lengths to be matched. The parameters **ge** and **le** are only used if an ip-prefix is stated. When setting these parameters, set the **le** value to be less than 128, and the **ge** value to be less than or equal to the **le** value and greater than the ip-prefix mask length.

Prefix lists implicitly exclude prefixes that are not explicitly permitted in the prefix list. This means if a prefix that is being checked against the prefix list reaches the end of the prefix list without matching a permit or deny, this prefix will be denied.

Example To check the first 32 bits of the prefix 2001:db8:: and that the subnet mask must be greater than or equal to 34 and less than or equal to 40, enter the following commands:

```
awplus# configure terminal
awplus(config)# ipv6 prefix-list mylist seq 12345 permit
2001:db8::/32 ge 34 le 40
```

Related commands

- match ipv6 address
- show ipv6 prefix-list
- show running-config ipv6 prefix-list

match as-path

Overview Use this command to add an autonomous system (AS) path match clause to a route map entry. Specify the AS path attribute value or values to match by specifying the name of an AS path access list.

A BGP update message matches the route map if its attributes include AS path values that match the AS path access list.

Each entry of a route map can only match against one AS path access list in one AS path match clause. If the route map entry already has an AS path match clause, entering this command replaces that match clause with the new clause.

Note that AS path access lists and route map entries both specify an action of deny or permit. The action in the AS path access list determines whether the route map checks update messages for a given AS path value. The route map action and its **set** clauses determine what the route map does with update messages that contain that AS path value.

Use the **no** variant of this command to remove the AS path match clause from a route map entry.

Syntax `match as-path <as-path-listname>`
`no match as-path [<as-path-listname>]`

Parameter	Description
<code><as-path-listname></code>	Specifies an AS path access list name.

Mode Route-map Configuration

Usage notes This command is valid for BGP update messages only.

Example To add entry 34 to the route map called `myroute`, which will discard update messages if they contain the AS path values that are included in `myaccesslist`, use the commands:

```
awplus# configure terminal
awplus(config)# route-map myroute deny 34
awplus(config-route-map)# match as-path myaccesslist
```

Related commands [route-map](#)
[set as-path](#)
[show route-map](#)

Command changes Added to AlliedWare Plus prior to 5.4.6-1
Version 5.4.7-2.1: BGP support added for IEx510, x550 series
Version 5.4.7-2.4: BGP support added for IE300 series

match community

Overview Use this command to add a community match clause to a route map entry. Specify the community value or values to match by specifying a community list. To create the community list, enter Global Configuration mode and use the [ip community-list](#) command.

A BGP update message matches the route map if its attributes include community values that match the community list.

Each entry of a route map can only match against one community list in one community match clause. If the route map entry already has a community match clause, entering this command replaces that match clause with the new clause.

Note that community lists and route map entries both specify an action of deny or permit. The action in the community list determines whether the route map checks update messages for a given community value. The route map action and its **set** clauses determine what the route map does with update messages that contain that community value.

Use the **no** variant of this command to remove the community match clause from a route map.

Syntax

```
match community  
{<community-listname>|<1-99>|<100-199>} [exact-match]  
  
no match community  
[<community-listname>|<1-99>|<100-199>|exact-match]
```

Parameter	Description
<community-listname>	The community list name or number.
<1-99>	Community list number (standard range).
<100-199>	Community list number (expanded range).
exact-match	Exact matching of communities.

Mode Route-map Configuration

Usage notes This command is valid for BGP update messages only.

Communities are used to group and filter routes. They are designed to provide the ability to apply policies to large numbers of routes by using match and set commands. Community lists are used to identify and filter routes by their common attributes.

Example To add entry 3 to the route map called `myroute`, which will process update messages if they contain the community values that are included in `mylist`, use the commands:

```
awplus# configure terminal
awplus(config)# route-map myroute permit 3
awplus(config-route-map)# match community mylist
```

Related commands

- `ip community-list`
- `route-map`
- `set comm-list delete`
- `set community`
- `show route-map`

Command changes

- Added to AlliedWare Plus prior to 5.4.6-1
- Version 5.4.7-2.1: BGP support added for IEx510, x550 series
- Version 5.4.7-2.4: BGP support added for IE300 series

max-paths

Overview Use this command to set the number of equal-cost multi-path (ECMP) routes for eBGP or iBGP. You can install multiple BGP paths to the same destination to balance the load on the forwarding path.

Use the **no** variant of this command to disable this feature.

Syntax max-paths {ebgp|ibgp} <2-64>
no max-paths ebgp [<2-64>]
no max-paths ibgp [<2-64>]

Parameter	Description
ebgp	eBGP ECMP session.
ibgp	iBGP ECMP session.
<2-64>	Specifies the number of routes.

Mode Global Configuration

Usage notes This command is available for the default BGP instance and for IPV4 and IPV6 unicast addresses.

Example awplus# configure terminal
awplus(config)# router bgp 64501
awplus(config-router)# max-paths ebgp 2

Related commands [show ip route summary](#)

Command changes Added to AlliedWare Plus prior to 5.4.6-1
Version 5.4.7-2.1: BGP support added for IEx510, x550 series
Version 5.4.7-2.4: BGP support added for IE300 series

neighbor activate

Overview Use this command to enable the exchange of BGP IPv4 and BGP4+ IPv6 routes with a neighboring router, and also within either an IPv4 or an IPv6 specific address-family.

Use the **no** variant of this command to disable the exchange of information with a BGP or BGP4+ neighbor, in the Router Configuration or the Address Family Configuration mode.

Syntax `neighbor <neighborid> activate`
`no neighbor <neighborid> activate`

Parameter	Description
<neighborid>	{ <ip-address> <ipv6-addr> <peer-group> }
<ip-address>	Specify the address of an IPv4 BGP neighbor, in dotted decimal notation A.B.C.D.
<ipv6-addr>	Specify the address of an IPv6 BGP4+ neighbor, entered in hexadecimal in the format X:X::X:X.
<peer-group>	Enter the name of an existing peer-group. For information on how to create peer groups, refer to the neighbor peer-group (add a neighbor) command, and neighbor route-map command. When this parameter is used with this command, the command applies on all peers in the specified group.

Mode [BGP] Router Configuration or IPv4 Address Family Configuration

Mode [BGP4+] IPv6 Address Family Configuration

Usage [BGP] Use this command to enable the exchange of information to a neighbor. To exchange IPv4 or IPv6 prefixes with a BGP or a BGP4+ peer, you must configure this command for the peer or the peer group. This command only enables the exchange of information. You can establish peering without this command, but no prefixes and other information is sent until you apply this command to the neighbor.

This command triggers the device to start a BGP or BGP4+ peering relationship with the specified BGP or BGP4+ neighbor and start exchanging routes with that neighbor.

The command is required for neighbors configured in Address-Family Configuration mode, but it is not required in Router Configuration mode (that is, it does not affect the device's behavior).

Examples [BGP] To enable an exchange of routes with a neighboring router with the IPv4 address 10.10.10.1, enter the commands as shown below:

```
awplus# configure terminal
awplus(config)# router bgp 10
awplus(config-router)# neighbor 10.10.10.1 activate
```

To disable an exchange of routes with a neighboring router with the IPv4 address 10.10.10.1, enter the commands as shown below:

```
awplus# configure terminal
awplus(config)# router bgp 10
awplus(config-router)# no neighbor 10.10.10.1 activate
```

To enable an exchange of routes in Address Family Configuration mode with a neighboring router with the IPv4 address 10.10.10.1, enter the commands as shown below:

```
awplus# configure terminal
awplus(config)# router bgp 10
awplus(config-router)# address-family ipv4
awplus(config-router-af)# neighbor 10.10.10.1 activate
```

To disable an exchange of routes in Address Family Configuration mode with a neighboring router with the IPv4 address 10.10.10.1, enter the commands as shown below:

```
awplus# configure terminal
awplus(config)# router bgp 10
awplus(config-router)# address-family ipv4
awplus(config-router-af)# no neighbor 10.10.10.1 activate
```

To enable an exchange of routes with a neighboring router with the peer-group named group1, enter the commands as shown below:

```
awplus# configure terminal
awplus(config)# router bgp 10
awplus(config-router)# neighbor group1 peer-group
awplus(config-router)# neighbor 10.10.0.63 remote-as 10
awplus(config-router)# neighbor 10.10.0.63 peer-group group1
awplus(config-router)# neighbor group1 activate
```

To disable an exchange of routes with a neighboring router with the peer-group named group1, enter the commands as shown below:

```
awplus# configure terminal
awplus(config)# router bgp 10
awplus(config-router)# no neighbor group1 activate
```

Examples To enable an exchange of routes in IPv6 Address Family Configuration mode with a neighboring router with the IPv6 address 2001:0db8:010d::1, enter the commands as shown below:

[BGP4+]

```
awplus# configure terminal
awplus(config)# router bgp 10
awplus(config-router)# address-family ipv6
awplus(config-router-af)# neighbor 2001:0db8:010d::1 activate
```

To disable an exchange of routes in IPv6 Address Family Configuration mode with a neighboring router with the IPv6 address 2001:0db8:010d::1, enter the commands as shown below:

```
awplus# configure terminal
awplus(config)# router bgp 10
awplus(config-router)# address-family ipv6
awplus(config-router-af)# no neighbor 2001:0db8:010d::1
activate
```

To enable an exchange of routes with a neighboring router with the peer-group named group1, enter the commands as shown below:

```
awplus# configure terminal
awplus(config)# router bgp 10
awplus(config-router)# neighbor group1 peer-group
awplus(config-router)# neighbor 2001:0db8:010d::1 remote-as 10
awplus(config-router)# address-family ipv6
awplus(config-router-af)# neighbor 2001:0db8:010d::1
peer-group group1
awplus(config-router-af)# neighbor group1 activate
```

To disable an exchange of routes with a neighboring router with the peer-group named group1, enter the commands as shown below:

```
awplus# configure terminal
awplus(config)# router bgp 10
awplus(config-router)# address-family ipv6
awplus(config-router-af)# no neighbor group1 activate
```

Related commands [neighbor peer-group \(add a neighbor\)](#)
[neighbor route-map](#)

Command changes Added to AlliedWare Plus prior to 5.4.6-1
Version 5.4.6-2.1: VRF-lite support added to BGP for AR-series products
Version 5.4.7-2.1: BGP support added for IEx510, x550 series
Version 5.4.7-2.4: BGP support added for IE300 series

neighbor advertisement-interval

Overview Use this command to set the minimum interval between sending iBGP or eBGP routing updates for a given route. This command reduces the flapping of individual routes.

Use the **no** variant of this command to set the interval time to the default values (30 seconds for eBGP peers and 5 seconds for iBGP peers) for a given route.

Syntax `neighbor <neighborid> advertisement-interval <time>`
`no neighbor <neighborid> advertisement-interval [<time>]`

Parameter	Description
<code><neighborid></code>	{ <code><ip-address></code> <code><ipv6-addr></code> <code><peer-group></code> }
<code><ip-address></code>	Specify the address of an IPv4 BGP neighbor, in dotted decimal notation A.B.C.D.
<code><ipv6-addr></code>	Specify the address of an IPv6 BGP4+ neighbor, entered in hexadecimal in the format X:X::X:X.
<code><peer-group></code>	Enter the name of an existing peer-group. For information on how to create peer groups, refer to the neighbor peer-group (add a neighbor) command, and neighbor route-map command. When this parameter is used with this command, the command applies on all peers in the specified group. Note that if you apply an advertisement-interval value to a peer group it will apply to all members in the peer group.
<code><time></code>	<code><0-600></code> Advertisement -interval value in seconds.

Default The default interval between sending routing updates for a given route to eBGP peers is 30 seconds, and the default interval for a given route to iBGP peers is 5 seconds.

Mode Router Configuration

Usage notes Use this command to set the minimum interval between sending iBGP or eBGP routing updates for a given route. To reduce the flapping of routes to the internet, set a minimum advertisement interval, so iBGP or eBGP routing updates are sent per interval seconds.

BGP dampening can also be used to control the effects of flapping routes. See the [bgp dampening](#) command in this chapter, and the [Routing_Protocol Guide](#) for more information.

The advertisement-interval time value is the minimum time between the advertisement of Update messages sent from a BGP speaker to report changes to

eBGP or iBGP peers. This is the minimum time between two Update messages sent to iBGP or eBGP peers.

See the [neighbor as-origination-interval](#) command to set the interval time between messages to iBGP peers, which have prefixes within the local AS. Use this command instead of the [neighbor as-origination-interval](#) command for eBGP peers with prefixes not in the same AS and updates not in a local AS.

Examples [BGP]

```
awplus# configure terminal
awplus(config)# router bgp 10
awplus(config-router)# neighbor 10.10.0.3
advertisement-interval 45
awplus# configure terminal
awplus(config)# router bgp 10
awplus(config-router)# no neighbor 10.10.0.3
advertisement-interval
awplus# configure terminal
awplus(config)# router bgp 10
awplus(config-router)# neighbor group1 peer-group
awplus(config-router)# neighbor 10.10.0.3 remote-as 10
awplus(config-router)# neighbor 10.10.0.3 peer-group group1
awplus(config-router)# neighbor group1 advertisement-interval
45
awplus# configure terminal
awplus(config)# router bgp 10
awplus(config-router)# no neighbor group1
advertisement-interval
```

Examples
[BGP4+]

```
awplus# configure terminal
awplus(config)# router bgp 10
awplus(config-router)# neighbor 2001:0db8:010d::1
advertisement-interval 45
awplus# configure terminal
awplus(config)# router bgp 10
awplus(config-router)# no neighbor 2001:0db8:010d::1
advertisement-interval
awplus# configure terminal
awplus(config)# router bgp 10
awplus(config-router)# neighbor group1 peer-group
awplus(config-router)# neighbor 2001:0db8:010d::1 remote-as 10
awplus(config-router)# address-family ipv6
awplus(config-router-af)# neighbor 2001:0db8:010d::1
peer-group group1
awplus(config-router-af)# neighbor group1
advertisement-interval 45
awplus# configure terminal
awplus(config)# router bgp 10
awplus(config-router)# address-family ipv6
awplus(config-router-af)# no neighbor group1
advertisement-interval
```

Related commands

- [neighbor as-origination-interval](#)
- [neighbor peer-group \(add a neighbor\)](#)
- [neighbor route-map](#)
- [show bgp ipv6 neighbors \(BGP4+ only\)](#)
- [show ip bgp neighbors \(BGP only\)](#)

Command changes

- Added to AlliedWare Plus prior to 5.4.6-1
- Version 5.4.7-2.1: BGP support added for IEx510, x550 series
- Version 5.4.7-2.4: BGP support added for IE300 series

neighbor allowas-in

Overview Use this command to accept an AS_PATH with the specified Autonomous System (AS) number from inbound updates for both BGP and BGP4+ routes.

This command allows BGP and BGP4+ to accept prefixes with the same ASN in the AS_PATH attribute. This command allows BGP and BGP4+ to accept up to 10 instances, configured by the *<occurrences>* placeholder, of its own AN in the AS_PATH for a prefix.

Use the **no** variant of this command to revert to default functionality (disabled by default).

Syntax `neighbor <neighborid> allowas-in <occurrences>`
`no neighbor <neighborid> allowas-in`

Parameter	Description
<i><neighborid></i>	{ <i><ip-address></i> <i><ipv6-addr></i> <i><peer-group></i> }
<i><ip-address></i>	Specify the address of an IPv4 BGP neighbor, in dotted decimal notation A.B.C.D.
<i><ipv6-addr></i>	Specify the address of an IPv6 BGP4+ neighbor, entered in hexadecimal in the format X:X::X:X.
<i><peer-group></i>	Enter the name of an existing peer-group. For information on how to create peer groups, refer to the neighbor peer-group (add a neighbor) command, and neighbor route-map command. When this parameter is used with this command, the command applies on all peers in the specified group.
<i><occurrences></i>	<i><1-10></i> Specifies the number of occurrences of the AS number.

Default Disabled

Mode [BGP] Router Configuration or IPv4 Address Family Configuration

Mode [BGP4+] IPv6 Address Family Configuration

Usage Use this command to configure PE (Provider Edge) routers to allow re-advertisement of all prefixes containing duplicate Autonomous System Numbers (ASNs). In a hub and spoke configuration, a PE router re-advertises all prefixes containing duplicate ASNs. Specify the remote-as or peer-group first using the related commands. The command allows a receiving peer to accept prefixes with its own AN in the AS_PATH, up the maximum number of instances, as configured by the *<occurrences>* placeholder.

Examples [BGP]

```
awplus# configure terminal
awplus(config)# router bgp 10
awplus(config-router)# neighbor 10.10.0.1 allowas-in 3
awplus# configure terminal
awplus(config)# router bgp 10
awplus(config-router)# address-family ipv4
awplus(config-router-af)# neighbor 10.10.0.1 allowas-in 3
awplus# configure terminal
awplus(config)# router bgp 10
awplus(config-router)# no neighbor 10.10.0.1 allowas-in
awplus# configure terminal
awplus(config)# router bgp 10
awplus(config-router)# address-family ipv4
awplus(config-router-af)# no neighbor 10.10.0.1 allowas-in
awplus# configure terminal
awplus(config)# router bgp 10
awplus(config-router)# neighbor group1 peer-group
awplus(config-router)# neighbor 10.10.0.1 remote-as 10
awplus(config-router)# neighbor 10.10.0.1 peer-group group1
awplus(config-router)# neighbor group1 allowas-in 3
awplus# configure terminal
awplus(config)# router bgp 10
awplus(config-router)# address-family ipv4
awplus(config-router-af)# neighbor group1 allowas-in 3
```

Examples
[BGP4+]

```
awplus# configure terminal
awplus(config)# router bgp 10
awplus(config-router)# address-family ipv6
awplus(config-router-af)# neighbor 2001:0db8:010d::1
allowas-in 3
awplus# configure terminal
awplus(config)# router bgp 10
awplus(config-router)# address-family ipv6
awplus(config-router-af)# no neighbor 2001:0db8:010d::1
allowas-in
awplus# configure terminal
awplus(config)# router bgp 10
awplus(config-router)# neighbor group1 peer-group
awplus(config-router)# neighbor 2001:0db8:010d::1 remote-as 10
awplus(config-router)# address-family ipv6
awplus(config-router-af)# neighbor 2001:0db8:010d::1
peer-group group1
awplus(config-router-af)# neighbor group1 allowas-in 3
awplus# configure terminal
awplus(config)# router bgp 10
awplus(config-router)# address-family ipv6
awplus(config-router-af)# neighbor group1 allowas-in 3
```

Related commands [neighbor peer-group \(add a neighbor\)](#)
[neighbor route-map](#)

Command changes Added to AlliedWare Plus prior to 5.4.6-1
Version 5.4.7-2.1: BGP support added for IEx510, x550 series
Version 5.4.7-2.4: BGP support added for IE300 series

neighbor as-origination-interval

Overview Use this command to adjust the sending of AS (Autonomous System) origination routing updates to a specified iBGP peer. This command adjusts the rate at which updates are sent to a specified iBGP peer (15 seconds by default). You must set a rate when you enable it.

The as-origination-interval is the minimum time set between the advertisement of Update messages sent from a BGP speaker to an iBGP peer to report changes within the local AS.

Use the **no** variant of this command to reset the timer to the default value of 15 seconds.

Syntax [BGP] neighbor <neighbor_address> as-origination-interval <time>
no neighbor <neighbor_address> as-origination-interval [<time>]

Syntax [BGP4+] neighbor <ipv6-addr> as-origination-interval <time>
no neighbor <ipv6-addr> as-origination-interval [<time>]

Parameter	Description
<neighbor_address>	Specify a neighbor IPv4 address, in dotted decimal in the format A.B.C.D.
<ipv6-addr>	Specify an address of an IPv6 BGP4+ neighbor, entered in hexadecimal in the format X:X::X:X.
<time>	<1-600> Time in seconds.

Default The default interval between sending routing updates to iBGP peers, which include a prefix that originates from the local AS, is 15 seconds by default.

Mode Router Configuration

Usage This command is used to change the minimum interval between sending AS-origination routing updates. The update interval for iBGP peers can be set from 1 to 600 seconds.

For interoperability with other vendors' devices, we recommend using the default value. The AS origination interval timer may not be available to adjust on other vendors' devices. Applying the default of 15 seconds across the AS maintains a common timer policy.

AlliedWare Plus devices use the default 15 second AS Origination Interval timer as per RFC 4271, a 30 second keepalive timer, a 90 second hold timer, a 120 second connect timer, a 5 second iBGP peer route advertisement interval, and a 30 second eBGP peer route advertisement interval.

Cisco devices use a 60 second keepalive timer, a 180 second hold timer, and no iBGP peer route interval timer (0). Juniper devices use a 10 second AS Origination Interval timer.

The as-origination-interval time value is the minimum amount of time between the advertisement of Update messages sent from a BGP speaker to report changes within the local AS. This is the minimum time between two Update messages to iBGP peers, which contain a prefix that originates from the same AS. See the [neighbor advertisement-interval](#) command to set time between messages to eBGP peers.

Use this command instead of the [neighbor advertisement-interval](#) command for iBGP peers with prefixes in the same AS for updates only within a local AS.

Examples [BGP]

```
awplus# configure terminal
awplus(config)# router bgp 100
awplus(config-router)# neighbor 10.10.0.1
as-origination-interval 10
awplus# configure terminal
awplus(config)# router bgp 100
awplus(config-router)# no neighbor 10.10.0.1
as-origination-interval
```

Examples [BGP4+]

```
awplus# configure terminal
awplus(config)# router bgp 100
awplus(config-router)# neighbor 2001:0db8:010d::1
as-origination-interval 10
awplus# configure terminal
awplus(config)# router bgp 100
awplus(config-router)# no neighbor 2001:0db8:010d::1
as-origination-interval
```

Validation Commands

- [show bgp ipv6 neighbors](#) (BGP4+ only)
- [show ip bgp neighbors](#) (BGP only)

Related commands

- [neighbor advertisement-interval](#)
- [address-family](#)

Command changes

- Added to AlliedWare Plus prior to 5.4.6-1
- Version 5.4.7-2.1: BGP support added for IEx510, x550 series
- Version 5.4.7-2.4: BGP support added for IE300 series

neighbor attribute-unchanged

Overview Use this command to advertise unchanged BGP or BGP4+ attributes to the specified BGP or BGP4+ neighbor.

Use the **no** variant of this command to disable this function.

Syntax `neighbor <neighborid> attribute-unchanged
{as-path|next-hop|med}`
`no neighbor <neighborid> attribute-unchanged
{as-path|next-hop|med}`

Parameter	Description
<neighborid>	{<ip-address> ipv6-addr> <peer-group>}
<ip-address>	Specify the address of an IPv4 BGP neighbor, in dotted decimal notation A.B.C.D.
<ipv6-addr>	Specify the address of an IPv6 BGP4+ neighbor, entered in hexadecimal in the format X:X::X:X.
<peer-group>	Enter the name of an existing peer-group. For information on how to create peer groups, refer to the neighbor peer-group (add a neighbor) command, and neighbor route-map command. When this parameter is used with this command, the command applies on all peers in the specified group.
as-path	AS path attribute.
next-hop	Next hop attribute.
med	Multi Exit Discriminator.

Mode [BGP] Router Configuration or IPv4 Address Family Configuration

Mode [BGP4+] IPv6 Address Family Configuration

Usage notes Note that specifying this command with the optional **as-path** parameter has the same effect as invoking the [neighbor transparent-as](#) command.

Note this specifying this command with the optional **next-hop** parameter has the same effect as invoking the [neighbor transparent-next-hop](#) command.

Examples [BGP]

```
awplus# configure terminal
awplus(config)# router bgp 10
awplus(config-router)# neighbor 10.10.0.75 attribute-unchanged
as-path med
awplus# configure terminal
awplus(config)# router bgp 10
awplus(config-router)# no neighbor 10.10.0.75
attribute-unchanged as-path med
awplus# configure terminal
awplus(config)# router bgp 10
awplus(config-router)# address-family ipv4
awplus(config-router-af)# neighbor 10.10.0.75
attribute-unchanged as-path med
awplus# configure terminal
awplus(config)# router bgp 10
awplus(config-router)# address-family ipv4
awplus(config-router-af)# no neighbor 10.10.0.75
attribute-unchanged as-path med
awplus# configure terminal
awplus(config)# router bgp 10
awplus(config-router)# neighbor group1 peer-group
awplus(config-router)# neighbor 10.10.0.75 remote-as 10
awplus(config-router)# neighbor 10.10.0.75 peer-group group1
awplus(config-router)# neighbor group1 attribute-unchanged
as-path med
awplus# configure terminal
awplus(config)# router bgp 10
awplus(config-router)# no neighbor group1 attribute-unchanged
as-path med
```

Examples
[BGP4+]

```
awplus# configure terminal
awplus(config)# router bgp 10
awplus(config-router)# address-family ipv6
awplus(config-router-af)# neighbor 2001:0db8:010d::1
attribute-unchanged as-path med
awplus# configure terminal
awplus(config)# router bgp 10
awplus(config-router)# address-family ipv6
awplus(config-router-af)# no neighbor 2001:0db8:010d::1
attribute-unchanged as-path med
awplus# configure terminal
awplus(config)# router bgp 10
awplus(config-router)# neighbor group1 peer-group
awplus(config-router)# neighbor 2001:0db8:010d::1 remote-as 10
awplus(config-router)# address-family ipv6
awplus(config-router-af)# neighbor 2001:0db8:010d::1
peer-group group1
awplus(config-router-af)# neighbor group1 attribute-unchanged
as-path med
awplus# configure terminal
awplus(config)# router bgp 10
awplus(config-router)# address-family ipv6
awplus(config-router-af)# no neighbor group1
attribute-unchanged as-path med
```

Related commands

- [neighbor peer-group \(add a neighbor\)](#)
- [neighbor route-map](#)
- [neighbor transparent-as](#)
- [neighbor transparent-nexthop](#)

Command changes

- Added to AlliedWare Plus prior to 5.4.6-1
- Version 5.4.7-2.1: BGP support added for IEx510, x550 series
- Version 5.4.7-2.4: BGP support added for IE300 series

neighbor capability graceful-restart

Overview Use this command to configure the device to advertise the Graceful Restart Capability to BGP and BGP4+ neighbors.

Use the **no** variant of this command to configure the device so it does not advertise the Graceful Restart Capability to its neighbor.

Syntax `neighbor <neighborid> capability graceful-restart`
`no neighbor <neighborid> capability graceful-restart`

Parameter	Description
<neighborid>	{<ip-address> <ipv6-addr> <peer-group>}
<ip-address>	Specify the address of an IPv4 BGP neighbor, in dotted decimal notation A.B.C.D.
<ipv6-addr>	Specify the address of an IPv6 BGP4+ neighbor, entered in hexadecimal in the format X:X::X:X.
<peer-group>	Enter the name of an existing peer-group. For information on how to create peer groups, refer to the neighbor peer-group (add a neighbor) command, and neighbor route-map command. When this parameter is used with this command, the command applies on all peers in the specified group.

Default Disabled

Mode [BGP] Router Configuration or IPv4 Address Family Configuration

Mode [BGP4+] IPv6 Address Family Configuration

Usage Use the **neighbor capability graceful-restart** command to advertise to the BGP or BGP4+ neighbor routers the capability of graceful restart. First specify the BGP or BGP4+ neighbor's **remote-as** identification number as assigned by the neighbor router.

The graceful restart capability is advertised only when the graceful restart capability has been enabled using the [bgp graceful-restart](#) command.

Examples [BGP]

```
awplus# configure terminal
awplus(config)# router bgp 10
awplus(config-router)# neighbor 10.10.10.50 capability
graceful-restart
awplus# configure terminal
awplus(config)# router bgp 10
awplus(config-router)# no neighbor 10.10.10.50 capability
graceful-restart
awplus# configure terminal
awplus(config)# router bgp 10
awplus(config-router)# address-family ipv4
awplus(config-router-af)# neighbor 10.10.10.50 capability
graceful-restart
awplus# configure terminal
awplus(config)# router bgp 10
awplus(config-router)# address-family ipv4
awplus(config-router-af)# no neighbor 10.10.10.50 capability
graceful-restart
awplus# configure terminal
awplus(config)# router bgp 10
awplus(config-router)# neighbor group1 peer-group
awplus(config-router)# neighbor 10.10.10.50 remote-as 10
awplus(config-router)# neighbor 10.10.10.50 peer-group group1
awplus(config-router)# neighbor group1 capability
graceful-restart
awplus# configure terminal
awplus(config)# router bgp 10
awplus(config-router)# no neighbor group1 capability
graceful-restart
```

Examples
[BGP4+]

```
awplus# configure terminal
awplus(config)# router bgp 10
awplus(config-router)# address-family ipv6
awplus(config-router-af)# neighbor 2001:0db8:010d::1
capability graceful-restart
awplus# configure terminal
awplus(config)# router bgp 10
awplus(config-router)# address-family ipv6
awplus(config-router-af)# no neighbor 2001:0db8:010d::1
capability graceful-restart
awplus# configure terminal
awplus(config)# router bgp 10
awplus(config-router)# neighbor group1 peer-group
awplus(config-router)# neighbor 2001:0db8:010d::1 remote-as 10
awplus(config-router)# address-family ipv6
awplus(config-router-af)# neighbor 2001:0db8:010d::1
peer-group group1
awplus(config-router-af)# neighbor group1 capability
graceful-restart
awplus# configure terminal
awplus(config)# router bgp 10
awplus(config-router)# address-family ipv6
awplus(config-router-af)# no neighbor group1 capability
graceful-restart
```

Related commands

- [bgp graceful-restart](#)
- [neighbor peer-group \(add a neighbor\)](#)
- [neighbor route-map](#)
- [restart bgp graceful \(BGP only\)](#)

Command changes

- Added to AlliedWare Plus prior to 5.4.6-1
- Version 5.4.7-2.1: BGP support added for IEx510, x550 series
- Version 5.4.7-2.4: BGP support added for IE300 series

neighbor capability orf prefix-list

Overview Use this command to advertise ORF (Outbound Route Filters) capability to neighbors. Use this command to dynamically filter updates. The BGP speaker can advertise a prefix list with prefixes it wishes the peer to prune or filter from outgoing updates.

Use the **no** variant of this command to disable this function.

Syntax `neighbor <neighborid> capability orf prefix-list
{both|receive|send}`
`no neighbor <neighborid> capability orf prefix-list
{both|receive|send}`

Parameter	Description
<neighborid>	{<ip-address> <ipv6-addr> <peer-group> }
<ip-address>	Specify the address of an IPv4 BGP neighbor, in dotted decimal notation A.B.C.D.
<ipv6-addr>	Specify the address of an IPv6 BGP4+ neighbor, entered in hexadecimal in the format X:X::X:X.
<peer-group>	Enter the name of an existing peer-group. For information on how to create peer groups, refer to the neighbor peer-group (add a neighbor) command, and neighbor route-map command. When this parameter is used with this command, the command applies on all peers in the specified group.
orf	Advertises ORF capability to its neighbors.
both	Indicates that the local router can send ORF entries to its peer as well as receive ORF entries from its peer.
receive	Indicates that the local router is willing to receive ORF entries from its peer.
send	Indicates that the local router is willing to send ORF entries to its peer.

Mode [BGP] Router Configuration or IPv4 Address Family Configuration

Mode [BGP4+] IPv6 Address Family Configuration

Default Disabled

Usage notes Outbound Route Filters (ORFs) send and receive capabilities to lessen the number of updates exchanged between neighbors. By filtering updates, this option minimizes generating and processing of updates. The local router advertises the ORF capability in `send` mode and the remote router receives the ORF capability in

receive mode applying the filter as outbound policy. The two routers exchange updates to maintain the ORF for each router. Only an individual router or a peer-group can be configured to be in **receive** or **send** mode. A peer-group member cannot be configured in **receive** or **send** mode.

Examples [BGP]

```
awplus# configure terminal
awplus(config)# router bgp 10
awplus(config-router)# neighbor 10.10.0.5 capability orf
prefix-list both
awplus# configure terminal
awplus(config)# router bgp 10
awplus(config-router)# no neighbor 10.10.0.5 capability orf
prefix-list both
awplus# configure terminal
awplus(config)# router bgp 10
awplus(config-router)# address-family ipv4
awplus(config-router)# neighbor 10.10.0.5 capability orf
prefix-list both
awplus# configure terminal
awplus(config)# router bgp 10
awplus(config-router)# address-family ipv4
awplus(config-router)# no neighbor 10.10.0.5 capability orf
prefix-list both
awplus# configure terminal
awplus(config)# router bgp 10
awplus(config-router)# neighbor group1 peer-group
awplus(config-router)# neighbor 10.10.0.5 remote-as 10
awplus(config-router)# neighbor 10.10.0.5 peer-group group1
awplus(config-router)# neighbor group1 capability orf
prefix-list both
awplus# configure terminal
awplus(config)# router bgp 10
awplus(config-router)# no neighbor group1 capability orf
prefix-list both
```

Examples
[BGP4+]

```
awplus# configure terminal
awplus(config)# router bgp 10
awplus(config-router)# address-family ipv6
awplus(config-router)# neighbor 2001:0db8:010d::1 capability
orf prefix-list both

awplus# configure terminal
awplus(config)# router bgp 10
awplus(config-router)# address-family ipv6
awplus(config-router)# no neighbor 2001:0db8:010d::1 capability
orf prefix-list both

awplus# configure terminal
awplus(config)# router bgp 10
awplus(config-router)# neighbor group1 peer-group
awplus(config-router)# neighbor 2001:0db8:010d::1 remote-as 10
awplus(config-router)# address-family ipv6
awplus(config-router-af)# neighbor 2001:0db8:010d::1
peer-group group1
awplus(config-router-af)# neighbor group1 capability orf
prefix-list both

awplus# configure terminal
awplus(config)# router bgp 10
awplus(config-router)# address-family ipv6
awplus(config-router-af)# no neighbor group1 capability orf
prefix-list both
```

Related commands

- [neighbor capability orf prefix-list](#)
- [neighbor peer-group \(add a neighbor\)](#)
- [neighbor route-map](#)

Command changes

- Added to AlliedWare Plus prior to 5.4.6-1
- Version 5.4.7-2.1: BGP support added for IEx510, x550 series
- Version 5.4.7-2.4: BGP support added for IE300 series

neighbor capability route-refresh

Overview Use this command to advertise route-refresh capability to the specified BGP and BGP4+ neighbors.

Use the **no** variant of this command to disable this function

Syntax `neighbor <neighborid> capability route-refresh`
`no neighbor <neighborid> capability route-refresh`

Parameter	Description
<neighborid>	{ <ip-address> ipv6-addr> <peer-group> }
<ip-address>	Specify the address of an IPv4 BGP neighbor, in dotted decimal notation A.B.C.D.
<ipv6-addr>	Specify the address of an IPv6 BGP4+ neighbor, entered in hexadecimal in the format X:X::X:X.
<peer-group>	Enter the name of an existing peer-group. For information on how to create peer groups, refer to the neighbor peer-group (add a neighbor) command, and neighbor route-map command. When this parameter is used with this command, the command applies on all peers in the specified group.

Mode Router Configuration

Default Enabled

Usage Use this command to advertise to peer about route refresh capability support. If route refresh capability is supported, then router can dynamically request that the peer readvertises its Adj-RIB-Out.

Examples [BGP]

```
awplus# configure terminal
awplus(config)# router bgp 10
awplus(config-router)# neighbor 10.10.10.1 capability
route-refresh
awplus# configure terminal
awplus(config)# router bgp 10
awplus(config-router)# no neighbor 10.10.10.1 capability
route-refresh
awplus# configure terminal
awplus(config)# router bgp 10
awplus(config-router)# neighbor group1 peer-group
awplus(config-router)# neighbor 10.10.1.1 remote-as 10
awplus(config-router)# neighbor 10.10.1.1 peer-group group1
awplus(config-router)# neighbor group1 capability route-refresh
awplus# configure terminal
awplus(config)# router bgp 10
awplus(config-router)# no neighbor group1 capability
route-refresh
```

Examples [BGP4+]

```
awplus# configure terminal
awplus(config)# router bgp 10
awplus(config-router)# neighbor 2001:0db8:010d::1 capability
route-refresh
awplus# configure terminal
awplus(config)# router bgp 10
awplus(config-router)# no neighbor 2001:0db8:010d::1 capability
route-refresh
awplus# configure terminal
awplus(config)# router bgp 10
awplus(config-router)# neighbor group1 peer-group
awplus(config-router)# neighbor 2001:0db8:010d::1 remote-as 10
awplus(config-router)# address-family ipv6
awplus(config-router-af)# neighbor 2001:0db8:010d::1
peer-group group1
awplus(config-router-af)# exit
awplus(config-router)# neighbor group1 capability route-refresh
awplus# configure terminal
awplus(config)# router bgp 10
awplus(config-router)# no neighbor group1 capability
route-refresh
```

Related commands [neighbor peer-group \(add a neighbor\)](#)
[neighbor route-map](#)

Command changes Added to AlliedWare Plus prior to 5.4.6-1
Version 5.4.7-2.1: BGP support added for IEx510, x550 series
Version 5.4.7-2.4: BGP support added for IE300 series

neighbor collide-established

Overview Use this command to specify including a BGP or BGP4+ neighbor, already in an 'established' state, for conflict resolution when a TCP connection collision is detected.

Use the **no** variant of this command to remove a BGP or BGP4+ neighbor, already in an 'established' state, for conflict resolution when a TCP connection collision is detected.

Syntax `neighbor <neighborid> collide-established`
`no neighbor <neighborid> collide-established`

Parameter	Description
<neighborid>	{<ip-address> <ipv6-addr> <peer-group>}
<ip-address>	Specify the address of an IPv4 BGP neighbor, in dotted decimal notation A.B.C.D.
<ipv6-addr>	Specify the address of an IPv6 BGP4+ neighbor, entered in hexadecimal in the format X:X::X:X.
<peer-group>	Enter the name of an existing peer-group. For information on how to create peer groups, refer to the neighbor peer-group (add a neighbor) command, and neighbor route-map command. When this parameter is used with this command, the command applies on all peers in the specified group.

Mode Router Configuration

Usage notes This command must be used only when specially required. It is not required in most network deployments.

The associated functionality of including an 'established' neighbor into TCP connection collision conflict resolution is automatically enabled when neighbor is configured for BGP graceful-restart.

Examples [BGP]

```
awplus# configure terminal
awplus(config)# router bgp 10
awplus(config-router)# neighbor 10.10.10.1 collide-established
awplus# configure terminal
awplus(config)# router bgp 10
awplus(config-router)# no neighbor 10.10.10.1
collide-established
awplus# configure terminal
awplus(config)# router bgp 10
awplus(config-router)# neighbor group1 peer-group
awplus(config-router)# neighbor 10.10.10.1 remote-as 10
awplus(config-router)# neighbor 10.10.10.1 peer-group group1
awplus(config-router)# neighbor group1 collide-established
awplus# configure terminal
awplus(config)# router bgp 10
awplus(config-router)# no neighbor group1 collide-established
```

Examples [BGP4+]

```
awplus# configure terminal
awplus(config)# router bgp 10
awplus(config-router)# neighbor 2001:0db8:010d::1
collide-established
awplus# configure terminal
awplus(config)# router bgp 10
awplus(config-router)# no neighbor 2001:0db8:010d::1
collide-established
awplus# configure terminal
awplus(config)# router bgp 10
awplus(config-router)# neighbor group1 peer-group
awplus(config-router)# neighbor 2001:0db8:010d::1 remote-as 10
awplus(config-router)# address-family ipv6
awplus(config-router-af)# neighbor 2001:0db8:010d::1
peer-group group1
awplus(config-router-af)# exit
awplus(config-router)# neighbor group1 collide-established
awplus# configure terminal
awplus(config)# router bgp 10
awplus(config-router)# no neighbor group1 collide-established
```

Related commands [neighbor peer-group \(add a neighbor\)](#)
[neighbor route-map](#)

Command changes Added to AlliedWare Plus prior to 5.4.6-1
Version 5.4.7-2.1: BGP support added for IEx510, x550 series
Version 5.4.7-2.4: BGP support added for IE300 series

neighbor default-originate

Overview Use this command to allow a BGP or BGP4+ local router to send the default route to a neighbor.

Use the **no** variant of this command to send no route as a default route.

Syntax `neighbor {<neighborid>} default-originate [route-map <routemap-name>]`
`no neighbor {<neighborid>} default-originate [route-map <routemap-name>]`

Parameter	Description
<neighborid>	{<ip-address> <ipv6-addr> <peer-group>}
<ip-address>	Specify the address of an IPv4 BGP neighbor, in dotted decimal notation A.B.C.D.
<ipv6-addr>	Specify the address of an IPv6 BGP4+ neighbor, entered in hexadecimal in the format X:X::X:X.
<peer-group>	Enter the name of an existing peer-group. For information on how to create peer groups, refer to the neighbor peer-group (add a neighbor) command, and neighbor route-map command. When this parameter is used with this command, the command applies on all peers in the specified group.
route-map	If a route-map is specified, then the route table must contain at least one route that matches the permit criteria of the route map before the default route will be advertised to the specified neighbor.
<routemap-name>	Enter the route-map name.

Mode [BGP] Router Configuration or IPv4 Address Family Configuration

Mode [BGP4+] IPv6 Address Family Configuration

Examples [BGP] To allow a device to originate default route to neighbor 10.10.10.1, when the device's route table contains at least one route matching the route map 'myroute', use the commands:

```
awplus# configure terminal
awplus(config)# router bgp 10
awplus(config-router)# neighbor 10.10.10.1 default-originate
route-map myroute
```

To stop a device from originating default route to neighbor 10.10.10.1, use the commands:

```
awplus# configure terminal
awplus(config)# router bgp 10
awplus(config-router)# no neighbor 10.10.10.1 default-originate
route-map myroute
```

To allow a device to originate the IPv4 default route to neighbor 10.10.10.1, when the device's route table contains at least one route matching the route map 'myroute', use the commands:

```
awplus# configure terminal
awplus(config)# router bgp 10
awplus(config)# address-family ipv4
awplus(config-router-af)# neighbor 10.10.10.1
default-originate route-map myroute
```

To stop a device from originating IPv4 default route to neighbor 10.10.10.1, use the commands:

```
awplus# configure terminal
awplus(config)# router bgp 10
awplus(config)# address-family ipv4
awplus(config-router-af)# no neighbor 10.10.10.1
default-originate route-map myroute
```

To allow a device to originate default route to peer group 'group1', when the device's route table contains at least one route matching the route map 'myroute', use the commands:

```
awplus# configure terminal
awplus(config)# router bgp 10
awplus(config-router)# neighbor group1 peer-group
awplus(config-router)# neighbor 10.10.10.1 remote-as 10
awplus(config-router)# neighbor 10.10.10.1 peer-group group1
awplus(config-router)# neighbor group1 default-originate
route-map myroute
```

To stop a device originating default route to peer group 'group1', use the commands:

```
awplus# configure terminal
awplus(config)# router bgp 10
awplus(config-router)# no neighbor group1 default-originate
route-map myroute
```

Examples To allow a device to originate default route to neighbor 2001:0db8:010d::1, when
[BGP4+] the device's route table contains at least one route matching the route map 'myroute', use the commands:

```
awplus# configure terminal
awplus(config)# router bgp 10
awplus(config-router)# address-family ipv6
awplus(config-router-af)# neighbor 2001:0db8:010d::1
default-originate route-map myroute
```

To stop a device originating default route to neighbor 2001:0db8:010d::1, use the commands:

```
awplus# configure terminal
awplus(config)# router bgp 10
awplus(config-router)# address-family ipv6
awplus(config-router-af)# no neighbor 2001:0db8:010d::1
default-originate route-map myroute
```

To allow a device to originate default route to peer group 'group1', when the device's route table contains at least one route matching the route map 'myroute', use the commands:

```
awplus# configure terminal
awplus(config)# router bgp 10
awplus(config-router)# neighbor group1 peer-group
awplus(config-router)# neighbor 2001:0db8:010d::1 remote-as 10
awplus(config-router)# address-family ipv6
awplus(config-router-af)# neighbor 2001:0db8:010d::1
peer-group group1
awplus(config-router-af)# neighbor group1 default-originate
route-map myroute
```

To stop a device originating default route to peer group 'group1', use the commands:

```
awplus# configure terminal
awplus(config)# router bgp 10
awplus(config-router)# address-family ipv6
awplus(config-router-af)# no neighbor group1 default-originate
route-map myroute
```

Related commands [neighbor peer-group \(add a neighbor\)](#)
[neighbor route-map](#)

Command changes Added to AlliedWare Plus prior to 5.4.6-1
Version 5.4.7-2.1: BGP support added for IEx510, x550 series
Version 5.4.7-2.4: BGP support added for IE300 series

neighbor description

Overview Use this command to associate a description with a BGP or a BGP4+ neighbor. We recommend adding descriptions to defined neighbors, so any network administrators or network engineers can see a description of connected BGP or BGP4+ peers on the device.

Use the **no** variant of this command to remove the description from a BGP or a BGP4+ neighbor.

Syntax `neighbor <neighborid> description <description>`
`no neighbor <neighborid> description [<description>]`

Parameter	Description
<code><neighborid></code>	{ <code><ip-address></code> <code><ipv6-addr></code> <code><peer-group></code> }
<code><ip-address></code> >	Specify the address of an IPv4 BGP neighbor, in dotted decimal notation A.B.C.D.
<code><ipv6-addr></code>	Specify the address of an IPv6 BGP4+ neighbor, entered in hexadecimal in the format X:X::X:X.
<code><peer-group></code> >	Enter the name of an existing peer-group. For information on how to create peer groups, refer to the neighbor peer-group (add a neighbor) command, and neighbor route-map command. When this parameter is used with this command, the command applies on all peers in the specified group.
<code><description></code>	Enter up to 80 characters of text describing the neighbor.

Mode [BGP] Router Configuration or IPv4 Address Family Configuration

Mode [BGP4+] Router Configuration

Examples [BGP]

```
awplus# configure terminal
awplus(config)# router bgp 10
awplus(config-router)# neighbor 10.10.10.1 description Backup
router for sales

awplus# configure terminal
awplus(config)# router bgp 10
awplus(config-router)# no neighbor 10.10.10.1 description

awplus# configure terminal
awplus(config)# router bgp 10
awplus(config-router)# neighbor group1 peer-group
awplus(config-router)# neighbor 10.10.10.1 remote-as 10
awplus(config-router)# neighbor 10.10.10.1 peer-group group1
awplus(config-router)# neighbor group1 description Backup
router for sales

awplus# configure terminal
awplus(config)# router bgp 10
awplus(config-router)# neighbor group1 description Backup
router for sales.
```

Examples [BGP4+]

```
awplus# configure terminal
awplus(config)# router bgp 10
awplus(config-router)# neighbor 2001:0db8:010d::1 description
Backup router for sales

awplus# configure terminal
awplus(config)# router bgp 10
awplus(config-router)# no neighbor 2001:0db8:010d::1
description

awplus# configure terminal
awplus(config)# router bgp 10
awplus(config-router)# neighbor group1 peer-group
awplus(config-router)# neighbor 2001:0db8:010d::1 remote-as 10
awplus(config-router)# address-family ipv6
awplus(config-router-af)# neighbor 2001:0db8:010d::1
peer-group group1
awplus(config-router-af)# exit
awplus(config-router)# neighbor group1 description Backup
router for sales

awplus# configure terminal
awplus(config)# router bgp 10
awplus(config-router)# no neighbor group1 description Backup
router for sales
```

Related commands [neighbor peer-group \(add a neighbor\)](#)
[neighbor route-map](#)

Command changes Added to AlliedWare Plus prior to 5.4.6-1
Version 5.4.7-2.1: BGP support added for IEx510, x550 series
Version 5.4.7-2.4: BGP support added for IE300 series

neighbor disallow-infinite-holdtime

Overview Use this command to disallow the configuration of infinite holdtime for BGP and BGP4+.

Use the **no** variant of this command to allow the configuration of infinite holdtime for BGP or BGP4+.

Syntax [BGP] neighbor {<ip-address>} disallow-infinite-holdtime
no neighbor {<ip-address>} disallow-infinite-holdtime

Syntax [BGP4+] neighbor {<ipv6-addr>} disallow-infinite-holdtime
no neighbor {<ipv6-addr>} disallow-infinite-holdtime

Parameter	Description
<ip-address>	Specify the address of an IPv4 BGP neighbor, in dotted decimal notation A.B.C.D.
<ipv6-addr>	Specify the address of an IPv6 BGP4+ neighbor, entered in hexadecimal in the format X:X::X:X.

Mode Router Configuration

Usage This command enables the local BGP or BGP4+ speaker to reject holdtime "0" seconds from the peer during exchange of open messages or the user during configuration.

The **no** variant of this command allows the BGP speaker to accept "0" holdtime from the peer or during configuration.

Examples [BGP] To enable the **disallow-infinite-holdtime** feature on the BGP speaker with the IP address of 10.10.10.1, enter the command:

```
awplus# configure terminal
awplus(config)# router bgp 10
awplus(config-router)# neighbor 10.10.10.1
disallow-infinite-holdtime
```

To disable the **disallow-infinite-holdtime** feature on the BGP speaker with the IP address of 10.10.10.10, enter the command:

```
awplus# configure terminal
awplus(config)# router bgp 10
awplus(config-router)# no neighbor 10.10.10.1
disallow-infinite-holdtime
```

Examples To enable the **disallow-infinite-holdtime** feature on the BGP4+ speaker with the IPv6 address of 2001:0db8:010d::1, enter the commands:

[BGP4+]

```
awplus# configure terminal
awplus(config)# router bgp 10
awplus(config-router)# neighbor
disallow-infinite-holdtime2001:0db8:010d::1
```

To disable the **disallow-infinite-holdtime** feature on the BGP4+ speaker with the IPv6 address of 2001:0db8:010d::1, enter the commands:

```
awplus# configure terminal
awplus(config)# router bgp 10
awplus(config-router)# no neighbor
disallow-infinite-holdtime2001:0db8:010d::1
```

Related commands [neighbor timers](#)

Command changes Added to AlliedWare Plus prior to 5.4.6-1
Version 5.4.7-2.1: BGP support added for IEx510, x550 series
Version 5.4.7-2.4: BGP support added for IE300 series

neighbor dont-capability-negotiate

Overview Use this command to disable capability negotiation for BGP and BGP4+.

The capability negotiation is performed by default. This command is used to allow compatibility with older BGP versions that have no capability parameters used in open messages between peers.

Use the **no** variant of this command to enable capability negotiation.

Syntax `neighbor <neighborid> dont-capability-negotiate`
`no neighbor <neighborid> dont-capability-negotiate`

Parameter	Description
<neighborid>	{<ip-address> <ipv6-addr> <peer-group> }
<ip-address>	Specify the IPv4 address of the BGP neighbor in dotted decimal, in the format A.B.C.D.
<ipv6-addr>	Specify the IPv6 address of the BGP4+ neighbor, entered in hexadecimal in the format X:X::X:X.
<peer-group>	Enter the name of an existing peer-group. For information on how to create peer groups, refer to the neighbor peer-group (add a neighbor) and neighbor route-map commands. When this parameter is used with this command, the command applies on all peers in the specified group.

Mode Router Configuration

Examples [BGP]

```
awplus# configure terminal
awplus(config)# router bgp 10
awplus(config-router)# neighbor 10.10.0.34
dont-capability-negotiate
awplus# configure terminal
awplus(config)# router bgp 10
awplus(config-router)# no neighbor 10.10.0.34
dont-capability-negotiate
awplus# configure terminal
awplus(config)# router bgp 10
awplus(config-router)# neighbor group1 peer-group
awplus(config-router)# neighbor 10.10.10.34 remote-as 100
awplus(config-router)# neighbor 10.10.10.34 peer-group group1
awplus(config-router)# neighbor group1
dont-capability-negotiate
awplus# configure terminal
awplus(config)# router bgp 10
awplus(config-router)# no neighbor group1
dont-capability-negotiate
```

Examples [BGP4+]

```
awplus# configure terminal
awplus(config)# router bgp 10
awplus(config-router)# neighbor 2001:0db8:010d::1
dont-capability-negotiate
awplus# configure terminal
awplus(config)# router bgp 10
awplus(config-router)# no neighbor 2001:0db8:010d::1
dont-capability-negotiate
awplus# configure terminal
awplus(config)# router bgp 10
awplus(config-router)# neighbor group1 peer-group
awplus(config-router)# neighbor 2001:0db8:010d::1 remote-as 100
awplus(config-router)# address-family ipv6
awplus(config-router-af)# neighbor 2001:0db8:010d::1
peer-group group1
awplus(config-router-af)# exit
awplus(config-router)# neighbor group1
dont-capability-negotiate
awplus# configure terminal
awplus(config)# router bgp 10
awplus(config-router)# no neighbor group1
dont-capability-negotiate
```

Related commands [neighbor peer-group \(add a neighbor\)](#)
[neighbor route-map](#)

Command changes Added to AlliedWare Plus prior to 5.4.6-1
Version 5.4.7-2.1: BGP support added for IEx510, x550 series
Version 5.4.7-2.4: BGP support added for IE300 series

neighbor ebgp-multihop

Overview Use this command to accept and attempt BGP or BGP4+ connections to external peers on indirectly connected networks.

Effectively, this command sets the TTL value in the BGP or BGP4+ packets that the router sends to the neighbor, so that the packets may traverse the network route to the neighbor.

The device will not establish a connection to a multihop neighbor, if the only route to the multihop peer is a default route.

Use the **no** variant of this command to return to the default.

Syntax `neighbor <neighborid> ebgp-multihop [<count>]`
`no neighbor <neighborid> ebgp-multihop [<count>]`

Parameter	Description
<code><neighborid></code>	{ <code><ip-address ipv6-addr <peer-group></code> }
<code><ip-addr></code>	Specify the address of an IPv4 BGP neighbor, entered in dotted decimal notation A.B.C.D.
<code><ipv6-addr></code>	Specify the address of an IPv6 BGP4+ neighbor, entered in hexadecimal in the format X:X::X:X.
<code><peer-group></code>	Enter the name of an existing peer-group. For information on how to create peer groups, refer to the neighbor peer-group (add a neighbor) command, and neighbor route-map command. When this parameter is used with this command, the command applies on all peers in the specified group.
<code><count></code>	<code><1-255></code> The Maximum hop count, that is set in the TTL field of the BGP packets. If this optional parameter is not specified with the command, then the Maximum hop count is set to 255.

Mode [BGP] Router Configuration or IPv4 Address Family Configuration

Mode [BGP4+] Router Configuration

Examples [BGP]

```
awplus# configure terminal
awplus(config)# router bgp 10
awplus(config-router)# neighbor 10.10.10.34 remote-as 10
awplus(config-router)# neighbor 10.10.10.34 ebgp-multihop 5
awplus# configure terminal
awplus(config)# router bgp 10
awplus(config-router)# no neighbor 10.10.10.34 ebgp-multihop 5
awplus# configure terminal
awplus(config)# router bgp 10
awplus(config-router)# neighbor group1 peer-group
awplus(config-router)# neighbor 10.10.10.34 remote-as 10
awplus(config-router)# neighbor 10.10.10.34 peer-group group1
awplus(config-router)# neighbor group1 ebgp-multihop 5
awplus# configure terminal
awplus(config)# router bgp 10
awplus(config-router)# no neighbor group1 ebgp-multihop 5
```

Examples [BGP4+]

```
awplus# configure terminal
awplus(config)# router bgp 10
awplus(config-router)# neighbor 2001:0db8:010d::1 remote-as 10
awplus(config-router)# neighbor 2001:0db8:010d::1
ebgp-multihop 5
awplus# configure terminal
awplus(config)# router bgp 10
awplus(config-router)# no neighbor 2001:0db8:010d::1
ebgp-multihop 5
awplus# configure terminal
awplus(config)# router bgp 10
awplus(config-router)# neighbor group1 peer-group
awplus(config-router)# neighbor 2001:0db8:010d::1 remote-as 10
awplus(config-router)# address-family ipv6
awplus(config-router-af)# neighbor 2001:0db8:010d::1
peer-group group1
awplus(config-router-af)# exit
awplus(config-router)# neighbor group1 ebgp-multihop 5
awplus# configure terminal
awplus(config)# router bgp 10
awplus(config-router)# no neighbor group1 ebgp-multihop 5
```

Related commands `neighbor ebgp-multihop`
`neighbor peer-group (add a neighbor)`
`neighbor route-map`

Command changes Added to AlliedWare Plus prior to 5.4.6-1
Version 5.4.7-2.1: BGP support added for IEx510, x550 series
Version 5.4.7-2.4: BGP support added for IE300 series

neighbor enforce-multihop

Overview Use this command to enforce the requirement that BGP and BGP4+ neighbors form multihop connections.

Use the **no** variant of this command to turn off this feature.

Syntax `neighbor <neighborid> enforce-multihop`
`no neighbor <neighborid> enforce-multihop`

Parameter	Description
<neighborid>	{<ip-address> <ipv6-addr> <peer-group>}
<ip-address>	The address of an IPv4 BGP neighbor, in dotted decimal notation A.B.C.D.
<ipv6-addr>	The address of an IPv6 BGP4+ neighbor, entered in hexadecimal in the format X:X::X:X.
<peer-group>	Name of an existing peer-group. For information on how to create peer groups, refer to the neighbor peer-group (add a neighbor) command, and neighbor route-map command. When this parameter is used with this command, the command applies on all peers in the specified group.

Mode [BGP] Router Configuration or IPv4 Address Family Configuration

Mode [BGP4+] Router Configuration

Examples [BGP]

```
awplus# configure terminal
awplus(config)# router bgp 10
awplus(config-router)# neighbor 10.10.0.34 remote-as 10
awplus(config-router)# neighbor 10.10.0.34 enforce-multihop
awplus# configure terminal
awplus(config)# router bgp 10
awplus(config-router)# no neighbor 10.10.0.34 enforce-multihop
awplus# configure terminal
awplus(config)# router bgp 10
awplus(config-router)# neighbor group1 peer-group
awplus(config-router)# neighbor 10.10.10.34 remote-as 10
awplus(config-router)# neighbor 10.10.10.34 peer-group group1
awplus(config-router)# neighbor group1 enforce-multihop
awplus# configure terminal
awplus(config)# router bgp 10
awplus(config-router)# no neighbor group1 enforce-multihop
```

Examples [BGP4+]

```
awplus# configure terminal
awplus(config)# router bgp 10
awplus(config-router)# neighbor 2001:0db8:010d::1 remote-as 10
awplus(config-router)# neighbor 2001:0db8:010d::1
enforce-multihop
awplus# configure terminal
awplus(config)# router bgp 10
awplus(config-router)# no neighbor 2001:0db8:010d::1
enforce-multihop
awplus# configure terminal
awplus(config)# router bgp 10
awplus(config-router)# neighbor group1 peer-group
awplus(config-router)# neighbor 2001:0db8:010d::1 remote-as 10
awplus(config-router)# address-family ipv6
awplus(config-router-af)# neighbor 2001:0db8:010d::1
peer-group group1
awplus(config-router-af)# exit
awplus(config-router)# neighbor group1 enforce-multihop
awplus# configure terminal
awplus(config)# router bgp 10
awplus(config-router)# no neighbor group1 enforce-multihop
```

Related commands [neighbor peer-group \(add a neighbor\)](#)
[neighbor route-map](#)

Command changes Added to AlliedWare Plus prior to 5.4.6-1
Version 5.4.7-2.1: BGP support added for IEx510, x550 series
Version 5.4.7-2.4: BGP support added for IE300 series

neighbor filter-list

Overview This command creates a BGP or BGP4+ filter using an AS (Autonomous System) path list. This command specifies an AS path list, which it then applies to filter updates to and from a BGP or a BGP4+ neighbor

The **no** variant of this command removes the previously specified BGP or BGP4+ filter using access control lists.

Syntax `neighbor <neighborid> filter-list <listname> {in|out}`
`no neighbor <neighborid> filter-list <listname> {in|out}`

Parameter	Description
<code><neighborid></code>	Specify the identification method for the BGP or BGP4+ peer. Use one of the following formats: <ul style="list-style-type: none"><code><ip-address></code> Specify the address of an IPv4 BGP neighbor, in dotted decimal notation A.B.C.D.<code><ipv6-addr></code> Specify the address of an IPv6 BGP4+ neighbor, entered in hexadecimal in the format X:X::X:X.<code><peer-group></code> Enter the name of an existing peer-group. For information on how to create peer groups, refer to the neighbor peer-group (add a neighbor) command, and neighbor route-map command. When this parameter is used with this command, the command applies on all peers in the specified group.
<code><listname></code>	Specify the name of an AS (Autonomous System) path list.
<code>in</code>	Indicates that incoming advertised routes will be filtered.
<code>out</code>	Indicates that outgoing advertised routes will be filtered.

Mode [BGP] Router Configuration or IPv4 Address Family Configuration

Mode [BGP4+] IPv6 Address Family Configuration

Usage This command specifies a filter for updates based on a BGP AS (Autonomous System) path list.

Examples [BGP]

```
awplus# configure terminal
awplus(config)# router bgp 10
awplus(config-router)# neighbor 10.10.0.34 filter-list list1
out

awplus# configure terminal
awplus(config)# router bgp 10
awplus(config-router)# no neighbor 10.10.0.34 filter-list list1
out

awplus# configure terminal
awplus(config)# router bgp 10
awplus(config-router)# address-family ipv4
awplus(config-router-af)# neighbor 10.10.0.34 filter-list list1
out

awplus# configure terminal
awplus(config)# router bgp 10
awplus(config-router)# address-family ipv4
awplus(config-router-af)# no neighbor 10.10.0.34 filter-list
list1 out

awplus# configure terminal
awplus(config)# router bgp 10
awplus(config-router)# neighbor group1 peer-group
awplus(config-router)# neighbor 10.10.10.34 remote-as 10
awplus(config-router)# neighbor 10.10.10.34 peer-group group1
awplus(config-router)# neighbor group1 filter-list list1 out
awplus# configure terminal
awplus(config)# router bgp 10
awplus(config-router)# no neighbor group1 filter-list list1 out
```

Examples
[BGP4+]

```
awplus# configure terminal
awplus(config)# router bgp 10
awplus(config-router)# address-family ipv6
awplus(config-router-af)# neighbor 2001:0db8:010d::1
filter-list list1 out
awplus# configure terminal
awplus(config)# router bgp 10
awplus(config-router)# address-family ipv6
awplus(config-router-af)# no neighbor 2001:0db8:010d::1
filter-list list1 out
awplus# configure terminal
awplus(config)# router bgp 10
awplus(config-router)# neighbor group1 peer-group
awplus(config-router)# neighbor 2001:0db8:010d::1 remote-as 10
awplus(config-router)# address-family ipv6
awplus(config-router-af)# neighbor 2001:0db8:010d::1
peer-group group1
awplus(config-router-af)# neighbor group1 filter-list list1 out
awplus# configure terminal
awplus(config)# router bgp 10
awplus(config-router)# address-family ipv6
awplus(config-router-af)# no neighbor group1 filter-list list1
out
```

Related commands [neighbor peer-group \(add a neighbor\)](#)
[neighbor route-map](#)

Command changes Added to AlliedWare Plus prior to 5.4.6-1
Version 5.4.7-2.1: BGP support added for IEx510, x550 series
Version 5.4.7-2.4: BGP support added for IE300 series

neighbor interface

Overview Use this command to configure the interface name of a BGP4+ speaking neighbor. Use the **no** variant of this command to disable this function.

Syntax [BGP4+] neighbor {<ipv6-addr>|<ipaddress>} interface <interface>
no neighbor {<ipv6-addr>|<ipaddress>} interface <interface>

Parameter	Description
<ipaddress>	Specifies the IPv4 address of the BGP neighbor - entered in dotted decimal notation in the format A.B.C.D.
<ipv6-addr>	Specifies the IPv6 address of the BGP4+ neighbor, entered in hexadecimal in the format X:X::X:X.
<interface>	Specifies the name of the interface to reach the BGP neighbor over.

Mode [BGP4+] Router Configuration

Usage [BGP4+] This command is for use with BGP4+ peering. Use this command for BGP peering with IPv6 link local addresses.

Examples [BGP4+] To specify a neighbor of 10.10.0.72 over the interface eth1, use the commands:

```
awplus# configure terminal
awplus(config)# router bgp 10
awplus(config-router)# neighbor 10.10.0.72 interface eth1
```

To remove the neighbor of 10.10.0.72 over the interface eth1, use the commands:

```
awplus# configure terminal
awplus(config)# router bgp 10
awplus(config-router)# no neighbor 10.10.0.72 interface eth1
```

To specify a neighbor of 2001:0db8:010d::1 over the interface eth1, use the commands:

```
awplus# configure terminal
awplus(config)# router bgp 10
awplus(config-router)# neighbor 2001:0db8:010d::1 interface eth1
```

To remove the neighbor of 2001:0db8:010d::1 over the interface eth1, use the commands:

```
awplus# configure terminal
awplus(config)# router bgp 10
awplus(config-router)# no neighbor 2001:0db8:010d::1 interface eth1
```

Command changes Added to AlliedWare Plus prior to 5.4.6-1
Version 5.4.7-2.1: BGP support added for IEx510, x550 series
Version 5.4.7-2.4: BGP support added for IE300 series

neighbor local-as

Overview Use this command to configure a local AS number for the specified BGP or BGP4+ neighbor. This overrides the local AS number specified by the [router bgp](#) command.

Use the **no** variant of this command to remove the local AS number for the specified BGP or BGP4+ neighbor.

Syntax `neighbor <neighborid> local-as <as-number>`
`no neighbor <neighborid> local-as <as-number>`

Parameter	Description
<code><neighborid></code>	{ <code><ip-address></code> <code><ipv6-addr></code> <code><peer-group></code> }
<code><ip-address></code>	The address of an IPv4 BGP neighbor, in dotted decimal notation A.B.C.D.
<code><ipv6-addr></code>	The address of an IPv6 BGP4+ neighbor, entered in hexadecimal in the format X:X::X:X.
<code><peer-group></code>	Enter the name of an existing peer-group. For information on how to create peer groups, refer to the neighbor peer-group (add a neighbor) and neighbor route-map commands. When this parameter is used with this command, the command applies on all peers in the specified group.
<code><as-number></code>	<code><1-4294967295></code> Neighbor's Autonomous System (AS) number.

Mode [BGP] Router Configuration or IPv4 Address Family Configuration

Mode [BGP4+] Router Configuration

When VRF-lite is configured, this command allows internal BGP loopback connections between named VRFs and the default global routing instance to be configured to act as eBGP connections, instead of only iBGP.

Usage [BGP4+] When BGP4+ is configured, this command prepends the ASN as defined by the [router bgp](#) command, and adds the ASN as defined by the [neighbor local-as](#) command in front of the actual ASN as defined by the [router bgp](#) command. This makes the peer believe it is peering with the ASN as defined by the [neighbor local-as](#) command.

Examples [BGP]

```
awplus# configure terminal
awplus(config)# router bgp 10
awplus(config-router)# neighbor 10.10.0.34 local-as 1
awplus# configure terminal
awplus(config)# router bgp 10
awplus(config-router)# no neighbor 10.10.0.34 local-as 1
awplus# configure terminal
awplus(config)# router bgp 10
awplus(config-router)# neighbor group1 peer-group
awplus(config-router)# neighbor 10.10.10.34 remote-as 10
awplus(config-router)# neighbor 10.10.10.34 peer-group group1
awplus(config-router)# neighbor group1 local-as 1
awplus# configure terminal
awplus(config)# router bgp 10
awplus(config-router)# no neighbor group1 local-as 1
```

Examples [BGP4+]

```
awplus# configure terminal
awplus(config)# router bgp 10
awplus(config-router)# neighbor 2001:0db8:010d::1 local-as 1
awplus# configure terminal
awplus(config)# router bgp 10
awplus(config-router)# no neighbor 2001:0db8:010d::1 local-as 1
awplus# configure terminal
awplus(config)# router bgp 10
awplus(config-router)# neighbor group1 peer-group
awplus(config-router)# address-family ipv6
awplus(config-router-af)# neighbor 2001:0db8:010d::1
peer-group group1
awplus(config-router-af)# exit
awplus(config-router)# neighbor group1 local-as 1
awplus# configure terminal
awplus(config)# router bgp 10
awplus(config-router)# no neighbor group1 local-as 1
```

Related commands

- [neighbor peer-group \(add a neighbor\)](#)
- [neighbor route-map](#)
- [router bgp](#)

Command changes

- Added to AlliedWare Plus prior to 5.4.6-1
- Version 5.4.6-2.1: VRF-lite support added to BGP for AR-series products

Version 5.4.7-2.1: BGP support added for IEx510, x550 series

Version 5.4.7-2.4: BGP support added for IE300 series

neighbor maximum-prefix

Overview Use this command to control the number of prefixes that can be received from a BGP or a BGP4+ neighbor.

Use the **no** variant of this command to disable this function. Do not specify threshold to apply the default threshold of 75% for the maximum number of prefixes before this is applied.

Syntax `neighbor <neighborid> maximum-prefix <maximum>`
`no neighbor <neighborid> maximum-prefix [<maximum>]`

Parameter	Description
<code><neighborid></code>	{ <code><ip-address></code> <code><ipv6-addr></code> <code><peer-group></code> }
<code><ip-address></code>	Specify the address of an IPv4 BGP neighbor, in dotted decimal notation A.B.C.D.
<code><ipv6-addr></code>	Specify the address of an IPv6 BGP4+ neighbor, entered in hexadecimal in the format X:X::X:X.
<code><peer-group></code>	Name of an existing peer-group. For information on how to create peer groups, refer to the neighbor peer-group (add a neighbor) command, and neighbor route-map command. When this parameter is used with this command, the command applies on all peers in the specified group.
<code><maximum></code>	<code><maxprefix></code> [<code><threshold></code>] [<code>warning-only</code>]
<code><maxprefix></code>	<code><1-4294967295></code> Specifies the maximum number of prefixes permitted.
<code><threshold></code>	<code><1-100></code> Specifies the threshold value, 1 to 100 percent. 75% by default.
<code>warning-only</code>	Only gives a warning message when the limit is exceeded.

Default The default threshold value is 75%. If the threshold value is not specified this default is applied.

Mode [BGP] Router Configuration or IPv4 Address Family Configuration

Mode [BGP4+] IPv6 Address Family Configuration

Usage The **neighbor maximum-prefix** command allows the configuration of a specified number of prefixes that a BGP or a BGP4+ router is allowed to receive from a neighbor. When the `warning-only` option is not used, if any extra prefixes are received, the router ends the peering. A terminated peer, stays down until the **clear ip bgp** command is used.

Examples [BGP]

```
awplus# configure terminal
awplus(config)# router bgp 10
awplus(config-router)# neighbor 10.10.0.72 maximum-prefix 1244
warning-only

awplus# configure terminal
awplus(config)# router bgp 10
awplus(config-router)# no neighbor 10.10.0.72 maximum-prefix
1244 warning-only

awplus# configure terminal
awplus(config)# router bgp 10
awplus(config-router)# neighbor group1 peer-group
awplus(config-router)# neighbor 10.10.10.72 remote-as 10
awplus(config-router)# neighbor 10.10.10.72 peer-group group1
awplus(config-router)# neighbor group1 maximum-prefix 1244
warning-only

awplus# configure terminal
awplus(config)# router bgp 10
awplus(config-router)# no neighbor group1 maximum-prefix 1244
warning-only
```

Examples
[BGP4+]

```
awplus# configure terminal
awplus(config)# router bgp 10
awplus(config-router)# address-family ipv6
awplus(config-router-af)# neighbor 2001:0db8:010d::1
maximum-prefix 1244 warning-only
awplus# configure terminal
awplus(config)# router bgp 10
awplus(config-router)# address-family ipv6
awplus(config-router-af)# no neighbor 2001:0db8:010d::1
maximum-prefix 1244 warning-only
awplus# configure terminal
awplus(config)# router bgp 10
awplus(config-router)# neighbor group1 peer-group
awplus(config-router)# address-family ipv6
awplus(config-router-af)# neighbor 2001:0db8:010d::1
peer-group group1
awplus(config-router-af)# neighbor group1 maximum-prefix 1244
warning-only
awplus# configure terminal
awplus(config)# router bgp 10
awplus(config-router)# address-family ipv6
awplus(config-router-af)# no neighbor group1 maximum-prefix
1244 warning-only
```

Related commands [neighbor peer-group \(add a neighbor\)](#)
[neighbor route-map](#)

Command changes Added to AlliedWare Plus prior to 5.4.6-1
Version 5.4.7-2.1: BGP support added for IEx510, x550 series
Version 5.4.7-2.4: BGP support added for IE300 series

neighbor next-hop-self

Overview Use this command to configure the BGP or BGP4+ router as the next hop for a BGP or BGP4+ speaking neighbor or peer group.

Use the **no** variant of this command to disable this feature.

Syntax `neighbor <neighborid> next-hop-self`
`no neighbor <neighborid> next-hop-self`

Parameter	Description
<neighborid>	{ <ip-address> <ipv6-addr> <peer-group> }
<ip-address>	Specify the address of an IPv4 BGP neighbor, in dotted decimal notation A.B.C.D.
<ipv6-addr>	Specify the address of an IPv6 BGP4+ neighbor, entered in hexadecimal in the format X:X::X:X.
<peer-group>	Enter the name of an existing peer-group. For information on how to create peer groups, refer to the neighbor peer-group (add a neighbor) command, and neighbor route-map command. When this parameter is used with this command, the command applies on all peers in the specified group.

Mode [BGP] Router Configuration or IPv4 Address Family Configuration

Mode [BGP4+] IPv6 Address Family Configuration

Usage notes This command allows a BGP or BGP4+ router to change the next hop information that is sent to the iBGP peer. The next hop information is set to the IP address of the interface used to communicate with the neighbor.

This command can be run for a specific VRF instance.

Examples [BGP]

```
awplus# configure terminal
awplus(config)# router bgp 10
awplus(config-router)# neighbor 10.10.0.72 next-hop-self
awplus# configure terminal
awplus(config)# router bgp 10
awplus(config-router)# no neighbor 10.10.0.72 next-hop-self
awplus# configure terminal
awplus(config)# router bgp 10
awplus(config-router)# address-family ipv4
awplus(config-router)# neighbor 10.10.0.72 next-hop-self
awplus# configure terminal
awplus(config)# router bgp 10
awplus(config-router)# address-family ipv4
awplus(config-router)# no neighbor 10.10.0.72 next-hop-self
awplus# configure terminal
awplus(config)# router bgp 10
awplus(config-router)# neighbor group1 peer-group
awplus(config-router)# neighbor 10.10.10.72 remote-as 10
awplus(config-router)# neighbor 10.10.10.72 peer-group group1
awplus(config-router)# neighbor group1 next-hop-self
awplus# configure terminal
awplus(config)# router bgp 10
awplus(config-router)# no neighbor group1 next-hop-self
```

Examples
[BGP4+]

```
awplus# configure terminal
awplus(config)# router bgp 10
awplus(config-router)# address-family ipv6
awplus(config-router-af)# neighbor 2001:0db8:010d::1
next-hop-self
awplus# configure terminal
awplus(config)# router bgp 10
awplus(config-router)# address-family ipv6
awplus(config-router-af)# no neighbor 2001:0db8:010d::1
next-hop-self
awplus# configure terminal
awplus(config)# router bgp 10
awplus(config-router)# neighbor group1 peer-group
awplus(config-router)# neighbor 2001:0db8:010d::1 remote-as 10
awplus(config-router)# address-family ipv6
awplus(config-router-af)# neighbor 2001:0db8:010d::1
peer-group group1
awplus(config-router-af)# neighbor group1 next-hop-self
awplus# configure terminal
awplus(config)# router bgp 10
awplus(config-router)# address-family ipv6
awplus(config-router-af)# no neighbor group1 next-hop-self
```

Related commands [neighbor peer-group \(add a neighbor\)](#)
[neighbor route-map](#)

Command changes Added to AlliedWare Plus prior to 5.4.6-1
Version 5.4.7-2.1: BGP support added for IEx510, x550 series
Version 5.4.7-2.4: BGP support added for IE300 series

neighbor override-capability

Overview Use this command to override a capability negotiation result for BGP and BGP4+. Use the **no** variant of with this command to disable this function.

Syntax neighbor <neighborid> override-capability
no neighbor <neighborid> override-capability

Parameter	Description
<neighborid>	{<ip-address> <ipv6-addr> <peer-group>}
<ip-address>	Specify the address of an IPv4 BGP neighbor, in dotted decimal notation A.B.C.D.
<ipv6-addr>	Specify the address of an IPv6 BGP4+ neighbor, entered in hexadecimal in the format X:X::X:X.
<peer-group>	Enter the name of an existing peer-group. For information on how to create peer groups, refer to the neighbor peer-group (add a neighbor) command, and neighbor route-map command. When this parameter is used with this command, the command applies on all peers in the specified group.

Mode Router Configuration

Examples [BGP]

```
awplus# configure terminal
awplus(config)# router bgp 10
awplus(config-router)# neighbor 10.10.0.72 override-capability
awplus# configure terminal
awplus(config)# router bgp 10
awplus(config-router)# no neighbor 10.10.0.72
override-capability
awplus# configure terminal
awplus(config)# router bgp 10
awplus(config-router)# neighbor group1 peer-group
awplus(config-router)# neighbor 10.10.10.72 remote-as 10
awplus(config-router)# neighbor 10.10.10.72 peer-group group1
awplus(config-router)# neighbor group1 override-capability
awplus# configure terminal
awplus(config)# router bgp 10
awplus(config-router)# no neighbor group1 override-capability
```

Examples
[BGP4+]

```
awplus# configure terminal
awplus(config)# router bgp 12
awplus(config-router)# neighbor 2001:0db8:010d::1
override-capability
awplus# configure terminal
awplus(config)# router bgp 12
awplus(config-router)# no neighbor 2001:0db8:010d::1
override-capability
awplus# configure terminal
awplus(config)# router bgp 12
awplus(config-router)# neighbor group1 peer-group
awplus(config-router)# neighbor 2001:0db8:010d::1 remote-as 10
awplus(config-router)# address-family ipv6
awplus(config-router-af)# neighbor 2001:0db8:010d::1
peer-group group1
awplus(config-router-af)# exit
awplus(config-router)# neighbor group1 override-capability
awplus# configure terminal
awplus(config)# router bgp 12
awplus(config-router)# no neighbor group1 override-capability
```

Related commands [neighbor peer-group \(add a neighbor\)](#)
[neighbor route-map](#)

Command changes Added to AlliedWare Plus prior to 5.4.6-1
Version 5.4.7-2.1: BGP support added for IEx510, x550 series
Version 5.4.7-2.4: BGP support added for IE300 series

neighbor passive

Overview Use this command to configure the local BGP or BGP4+ router to be passive with regard to the specified BGP or BGP4+ neighbor. This has the effect that the BGP or BGP4+ router will not attempt to initiate connections to this BGP or BGP4+ neighbor, but will accept incoming connection attempts from the BGP or BGP4+ neighbor.

Use the **no** variant of this command to disable this function.

Syntax `neighbor <neighborid> passive`
`no neighbor <neighborid> passive`

Parameter	Description
<code><neighborid></code>	{ <code><ip-address></code> <code><ipv6-addr></code> <code><peer-group></code> }
<code><ip-address></code>	Specify the address of an IPv4 BGP neighbor, in dotted decimal notation A.B.C.D.
<code><ipv6-addr></code>	Specify the address of an IPv6 BGP4+ neighbor, entered in hexadecimal in the format X:X::X:X.
<code><peer-group></code>	Enter the name of an existing peer-group. For information on how to create peer groups, refer to the neighbor peer-group (add a neighbor) command, and neighbor route-map command. When this parameter is used with this command, the command applies on all peers in the specified group.

Mode [BGP] Router Configuration or IPv4 Address Family Configuration

Mode [BGP4+] Router Configuration

Examples [BGP]

```
awplus# configure terminal
awplus(config)# router bgp 10
awplus(config-router)# neighbor 10.10.0.72 passive
awplus# configure terminal
awplus(config)# router bgp 10
awplus(config-router)# no neighbor 10.10.0.72 passive
awplus# configure terminal
awplus(config)# router bgp 10
awplus(config-router)# neighbor group1 peer-group
awplus(config-router)# neighbor 10.10.10.72 remote-as 10
awplus(config-router)# neighbor 10.10.10.72 peer-group group1
awplus(config-router)# neighbor group1 passive
awplus# configure terminal
awplus(config)# router bgp 10
awplus(config-router)# no neighbor group1 passive
```

Examples [BGP4+]

```
awplus# configure terminal
awplus(config)# router bgp 10
awplus(config-router)# neighbor 2001:0db8:010d::1 passive
awplus# configure terminal
awplus(config)# router bgp 10
awplus(config-router)# no neighbor 2001:0db8:010d::1 passive
awplus# configure terminal
awplus(config)# router bgp 10
awplus(config-router)# neighbor group1 peer-group
awplus(config-router)# neighbor 2001:0db8:010d::1 remote-as 10
awplus(config-router)# address-family ipv6
awplus(config-router-af)# neighbor 2001:0db8:010d::1
peer-group group1
awplus(config-router-af)# exit
awplus(config-router)# neighbor group1 passive
awplus# configure terminal
awplus(config)# router bgp 10
awplus(config-router)# no neighbor group1 passive
```

Related commands [neighbor peer-group \(add a neighbor\)](#)
[neighbor route-map](#)

Command changes Added to AlliedWare Plus prior to 5.4.6-1
Version 5.4.7-2.1: BGP support added for IEx510, x550 series

Version 5.4.7-2.4: BGP support added for IE300 series

neighbor password

Overview Use this command to enable MD5 authentication on a TCP connection between BGP and BGP4+ neighbors. No authentication is applied by default. To setup authentication for the session, you must first apply authentication on each connected peer for the session.

Use the **no** variant of this command to disable this function.

Syntax [BGP] `neighbor {<ip-address>|<peer-group-name>} password <password>`
`no neighbor {<ip-address>|<peer-group-name>} password`
`[<password>]`

Syntax [BGP4+] `neighbor {<ipv6-addr>|<peer-group-name>} password <password>`
`no neighbor {<ipv6-addr>|<peer-group-name>} password`
`[<password>]`

Parameter	Description
<code><ip-address></code>	Specifies the IP address of the BGP neighbor, in A.B.C.D format.
<code><ipv6-addr></code>	Specifies the IPv6 address of the BGP4+ neighbor, entered in hexadecimal in the format X:X::X:X.
<code><peer-group-name></code>	Name of an existing peer-group. When this parameter is used with this command, the command applies on all peers in the specified group.
<code><password></code>	An alphanumeric string of characters to be used as password.

Default No authentication is applied by default.

Mode [BGP] Router Configuration or IPv4 Address Family Configuration

Mode [BGP4+] Router Configuration

Usage notes When using the `<peer-group-name>` parameter with this command (to apply this command to all peers in the group), see the related commands [neighbor peer-group \(add a neighbor\)](#) and [neighbor route-map](#) for information about how to create peer groups first.

Examples [BGP] This example specifies the encryption type and the password 'manager' for the neighbor 10.10.10.1:

```
awplus# configure terminal
awplus(config)# router bgp 10
awplus(config-router)# neighbor 10.10.10.1 password manager
```

This example removes the password set for the neighbor 10.10.10.1:

```
awplus# configure terminal
awplus(config)# router bgp 10
awplus(config-router)# no neighbor 10.10.10.1 password
```

This example specifies the encryption type and the password 'manager' for the neighbor peer group named 'group1':

```
awplus# configure terminal
awplus(config)# router bgp 10
awplus(config-router)# neighbor group1 peer-group
awplus(config-router)# neighbor 10.10.10.1 remote-as 10
awplus(config-router)# neighbor 10.10.10.1 peer-group group1
awplus(config-router)# neighbor group1 password manager
```

This example removes the password set for the neighbor peer group named group1:

```
awplus# configure terminal
awplus(config)# router bgp 10
awplus(config-router)# no neighbor group1 password
```

**Examples
(VRF-lite)**

This example specifies the password ('manager') for the neighbor peer group named 'group1' for an IPv4 address-family VRF instance name 'red', and router bgp 10:

```
awplus# configure terminal
awplus(config)# router bgp 10
awplus(config-router)# address-family ipv4 vrf red
awplus(config-router-af)# neighbor 10.10.10.1 password manager
```

This example removes the password ('manager') for the neighbor peer group named 'group1' for an IPv4 address-family, VRF instance name 'red', and router bgp 10:

```
awplus# configure terminal
awplus(config)# router bgp 10
awplus(config-router)# address-family ipv4 vrf red
awplus(config-router-af)# no neighbor 10.10.10.1 password
manager
```

This example specifies the password ('manager') for the neighbor peer group named 'group1' for an IPv4 address-family, VRF instance name 'red', and router bgp 10:

```
awplus# configure terminal
awplus(config)# router bgp 10
awplus(config-router)# neighbor group1 peer-group
awplus(config-router)# neighbor 10.10.10.1 remote-as 10
awplus(config-router)# neighbor 10.10.10.1 peer-group group1
awplus(config-router)# address-family ipv4 vrf red
awplus(config-router-af)# neighbor group1 password manager
```

Examples [BGP4+] This example specifies the encryption type and the password 'manager' for the neighbor 2001:0db8:010d::1:

```
awplus# configure terminal
awplus(config)# router bgp 10
awplus(config-router)# neighbor password manager
2001:0db8:010d::1
```

This example removes the password set for the neighbor 2001:0db8:010d::1:

```
awplus# configure terminal
awplus(config)# router bgp 10
awplus(config-router)# no neighbor password 2001:0db8:010d::1
```

This example specifies the encryption type and the password 'manager' for the neighbor peer group named group1:

```
awplus# configure terminal
awplus(config)# router bgp 10
awplus(config-router)# neighbor group1 peer-group
awplus(config-router)# neighbor remote-as 102001:0db8:010d::1
awplus(config-router)# address-family ipv6
awplus(config-router-af)# neighbor peer-group group1
2001:0db8:010d::1
awplus(config-router-af)# exit
awplus(config-router)# neighbor group1 password manager
```

This example removes the password set for the neighbor peer group named 'group1':

```
awplus# configure terminal
awplus(config)# router bgp 10
awplus(config-router)# no neighbor group1 password
```

Related commands [neighbor peer-group \(add a neighbor\)](#)
[neighbor route-map](#)

- Command changes**
- Added to AlliedWare Plus prior to 5.4.6-1
 - Version 5.4.6-2.1: VRF-lite support added to BGP for AR-series products
 - Version 5.4.7-2.1: BGP support added for IEx510, x550 series
 - Version 5.4.7-2.4: BGP support added for IE300 series

neighbor peer-group (add a neighbor)

Overview Use this command to add a BGP or a BGP4+ neighbor to an existing peer-group. Use the **no** variant of this command to disable this function.

Syntax [BGP] `neighbor <ip-address> peer-group <peer-group>`
`no neighbor <ip-address> peer-group <peer-group>`

Syntax [BGP4+] `neighbor <ipv6-addr> peer-group <peer-group>`
`no neighbor <ipv6-addr> peer-group <peer-group>`

Parameter	Description
<code><ip-address></code>	Specify the IPv4 address of the BGP neighbor, entered in the format A.B.C.D.
<code><ipv6-addr></code>	Specify the IPv6 address of the BGP4+ neighbor, entered in hexadecimal in the format X:X::X:X.
<code><peer-group></code>	Enter the name of the peer-group. When this parameter is used with this command, the command applies on all peers in the specified group.

Mode [BGP] Router Configuration or IPv4 Address Family Configuration

Mode [BGP4+] IPv6 Address Family Configuration

Usage Use this command to add neighbors with the same update policies to a peer group. This facilitates the updates of various policies, such as, distribute and filter lists. The peer-group is then configured easily with many of the neighbor commands. Any changes made to the peer group affect all members.

To create a peer-group use the [neighbor port](#) command and then use this command to add neighbors to the group.

Examples [BGP] This example shows a new peer-group `group1` and the addition of a neighbor `10.10.0.63` to the group.

```
awplus# configure terminal
awplus(config)# router bgp 10
awplus(config-router)# neighbor group1 peer-group
awplus(config-router)# neighbor 10.10.0.63 peer-group group1
```

This example shows a new peer-group `group1` and the removal of a neighbor `10.10.0.63` to the group.

```
awplus# configure terminal
awplus(config)# router bgp 10
awplus(config-router)# neighbor group1 peer-group
awplus(config-router)# no neighbor 10.10.0.63 peer-group group1
```

Examples [BGP4+] This example shows a new peer-group `group1` and the addition of a neighbor `2001:0db8:010d::1` to the group.

```
awplus# configure terminal
awplus(config)# router bgp 10
awplus(config-router)# neighbor group1 peer-group
awplus(config-router)# address-family ipv6
awplus(config-router-af)# neighbor peer-group
group12001:0db8:010d::1
```

This example shows a new peer-group `group1` and the removal of a neighbor `2001:0db8:010d::1` to the group.

```
awplus# configure terminal
awplus(config)# router bgp 10
awplus(config-router)# neighbor group1 peer-group
awplus(config-router)# address-family ipv6
awplus(config-router-af)# no neighbor peer-group
group12001:0db8:010d::1
```

Related commands [neighbor peer-group \(create a peer-group\)](#)
[neighbor port](#)

Command changes Added to AlliedWare Plus prior to 5.4.6-1
Version 5.4.7-2.1: BGP support added for IEx510, x550 series
Version 5.4.7-2.4: BGP support added for IE300 series

neighbor peer-group (create a peer-group)

Overview Use this command to create a peer-group for BGP and BGP4+. Use the **no** variant of this command to disable this function.

Syntax `neighbor <peer-group> peer-group`
`no neighbor <peer-group> peer-group`

Parameter	Description
<code><peer-group></code>	Enter the name of the peer-group.

Mode [BGP] Router Configuration or IPv4 Address Family Configuration

Mode [BGP4+] Router Configuration

Usage notes Neighbors with the same update policies are grouped into peer groups. This facilitates the updates of various policies, such as, distribute and filter lists. The peer-group is then configured easily with many of the neighbor commands. Any changes made to the peer group affect all members. Use this command to create a peer-group, then use the [neighbor peer-group \(add a neighbor\)](#) command to add neighbors to the group.

Examples

```
awplus# configure terminal
awplus(config)# router bgp 10
awplus(config-router)# neighbor group1 peer-group
awplus# configure terminal
awplus(config)# router bgp 10
awplus(config-router)# no neighbor group1 peer-group
```

Related commands [neighbor peer-group \(add a neighbor\)](#)

Command changes Added to AlliedWare Plus prior to 5.4.6-1
Version 5.4.7-2.1: BGP support added for IEx510, x550 series
Version 5.4.7-2.4: BGP support added for IE300 series

neighbor port

Overview Use this command to specify the TCP port to which packets are sent to on a BGP or a BGP4+ neighbor. TCP port 179 is the default port used to connect BGP and BGP4+ peers. You can specify a different destination port for the TCP session with this command.

Use the **no** variant of this command to reset the port number back to the default value (TCP port 179).

Syntax [BGP] `neighbor <neighborid> port <portnum>`
`no neighbor <neighborid> port [<portnum>]`

Parameter	Description
<code><neighborid></code>	{ <code><ip-address></code> <code>ipv6-addr</code> } <code><peer-group></code>
<code><ip-address></code>	Specify the address of an IPv4 BGP neighbor, in dotted decimal notation A.B.C.D.
<code><ipv6-addr></code>	Specify the address of an IPv6 BGP4+ neighbor, entered in hexadecimal in the format X:X::X:X.
<code><peer-group></code>	Enter the name of an existing peer-group. For information on how to create peer groups, refer to the neighbor peer-group (add a neighbor) command, and neighbor route-map command. When this parameter is used with this command, the command applies on all peers in the specified group.
<code><portnum></code>	<code><0-65535></code> Specifies the TCP port number.

Default TCP port 179 is the default port used to connect BGP and BGP4+ peers.

Mode [BGP] Router Configuration or IPv4 Address Family Configuration

Mode [BGP4+] Router Configuration

Examples [BGP]

```
awplus# configure terminal
awplus(config)# router bgp 12
awplus(config-router)# neighbor 10.10.10.10 port 643
awplus# configure terminal
awplus(config)# router bgp 12
awplus(config-router)# no neighbor 10.10.10.10 port 643
awplus# configure terminal
awplus(config)# router bgp 12
awplus(config-router)# neighbor group1 peer-group
awplus(config-router)# neighbor 10.10.10.1 remote-as 10
awplus(config-router)# neighbor 10.10.10.1 peer-group group1
awplus(config-router)# neighbor group1 port 643
awplus# configure terminal
awplus(config)# router bgp 12
awplus(config-router)# no neighbor group1 port 643
```

Examples [BGP4+]

```
awplus# configure terminal
awplus(config)# router bgp 12
awplus(config-router)# neighbor port 6432001:0db8:010d::1
awplus# configure terminal
awplus(config)# router bgp 12
awplus(config-router)# no neighbor port 6432001:0db8:010d::1
awplus# configure terminal
awplus(config)# router bgp 12
awplus(config-router)# neighbor group1 peer-group
awplus(config-router)# neighbor 2001:0db8:010d::1 remote-as 10
awplus(awplus-router)# address-family ipv6
awplus(config-router-af)# neighbor 2001:0db8:010d::1
peer-group group1
awplus(config-router-af)# exit
awplus(config-router)# neighbor group1 port 643
awplus# configure terminal
awplus(config)# router bgp 12
awplus(config-router)# no neighbor group1 port 643
```

Related commands [neighbor peer-group \(add a neighbor\)](#)
[neighbor route-map](#)

Command changes Added to AlliedWare Plus prior to 5.4.6-1
Version 5.4.7-2.1: BGP support added for IEx510, x550 series

Version 5.4.7-2.4: BGP support added for IE300 series

neighbor prefix-list

Overview Use this command to distribute BGP and BGP4+ neighbor information as specified in a prefix list.

Use the **no** variant of this command to remove an entry.

Syntax `neighbor <neighborid> prefix-list <listname> {in|out}`
`no neighbor <neighborid> prefix-list <listname> {in|out}`

Parameter	Description
<neighborid>	<ip-address> <ipv6-addr> <peer-group>
	<ip-address> Specify the address of an IPv4 BGP neighbor, in dotted decimal notation A.B.C.D.
	<ipv6-addr> Specify the address of an IPv6 BGP4+ neighbor, entered in hexadecimal in the format X:X::X:X.
	<peer-group> Enter the name of an existing peer-group. For information on how to create peer groups, refer to the neighbor peer-group (add a neighbor) command, and neighbor route-map command. When this parameter is used with this command, the command applies on all peers in the specified group.
<listname>	The name of an IP prefix list.
in	Specifies that the IP prefix list applies to incoming advertisements.
out	Specifies that the IP prefix list applies to outgoing advertisements.

Mode [BGP] Router Configuration or IPv4 Address Family Configuration

Mode [BGP4+] IPv6 Address Family Configuration

Usage notes Use this command to specify a prefix list for filtering BGP or BGP4+ advertisements. Filtering by prefix list matches the prefixes of routes with those listed in the prefix list. If there is a match, the route is used. An empty prefix list permits all prefixes. If a given prefix does not match any entries of a prefix list, the route is denied access.

The router begins the search at the top of the prefix list, with the sequence number 1. Once a match or deny occurs, the router does not need to go through the rest of the prefix list. For efficiency the most common matches or denies are listed at the top.

The **neighbor distribute-list** command is an alternative to the **neighbor prefix-list** command and only one of them can be used for filtering to the same neighbor in any direction.

Examples [BGP]

```
awplus# configure terminal
awplus(config)# ip prefix-list list1 deny 30.0.0.0/24
awplus(config)# router bgp 10
awplus(config-router)# neighbor 10.10.10.1 prefix-list list1 in
awplus# configure terminal
awplus(config)# router bgp 10
awplus(config-router)# no neighbor 10.10.10.1 prefix-list list1
in
awplus# configure terminal
awplus(config)# ip prefix-list list1 deny 30.0.0.0/24
awplus(config)# router bgp 10
awplus(config-router)# address-family ipv4
awplus(config-router-af)# neighbor 10.10.10.1 prefix-list list1
in
awplus# configure terminal
awplus(config)# router bgp 10
awplus(config-router)# address-family ipv4
awplus(config-router-af)# no neighbor 10.10.10.1 prefix-list
list1 in
awplus# configure terminal
awplus(config)# ip prefix-list list1 deny 30.0.0.0/24
awplus(config)# router bgp 10
awplus(config-router)# neighbor group1 peer-group
awplus(config-router)# neighbor 10.10.10.1 remote-as 10
awplus(config-router)# neighbor 10.10.10.1 peer-group group1
awplus(config-router)# neighbor group1 prefix-list list1 in
awplus# configure terminal
awplus(config)# router bgp 10
awplus(config-router)# no neighbor group1 prefix-list list1 in
```

Examples
[BGP4+]

```
awplus# configure terminal
awplus(config)# ipv6 prefix-list list1 deny
2001:0db8:010d::1/128

awplus(config)# router bgp 10
awplus(config-router)# address-family ipv6
awplus(config-router-af)# neighbor 2001:0db8:: prefix-list
list1 in

awplus# configure terminal
awplus(config)# router bgp 10
awplus(config-router)# address-family ipv6
awplus(config-router-af)# no neighbor 2001:0db8:: prefix-list
list1 in

awplus# configure terminal
awplus(config)# ip prefix-list list1 deny 2001:0db8:010d::1/128
awplus(config)# router bgp 10
awplus(config-router)# neighbor group1 peer-group
awplus(config-router)# neighbor 2001:0db8:010d::1 remote-as 10
awplus(config-router)# address-family ipv6
awplus(config-router-af)# neighbor 2001:0db8:010d::1
peer-group group1
awplus(config-router-af)# neighbor group1 prefix-list list1 in
awplus# configure terminal
awplus(config)# router bgp 10
awplus(config-router)# address-family ipv6
awplus(config-router-af)# no neighbor group1 prefix-list list1
in
```

Related commands

- [ip prefix-list](#)
- [neighbor peer-group \(add a neighbor\)](#)
- [neighbor route-map](#)

Command changes

- Added to AlliedWare Plus prior to 5.4.6-1
- Version 5.4.7-2.1: BGP support added for IEx510, x550 series
- Version 5.4.7-2.4: BGP support added for IE300 series

neighbor remote-as

Overview Use this command to configure an internal or external BGP or BGP4+ (iBGP or eBGP) peering relationship with another router.

Use the **no** variant of this command to remove a previously configured BGP or BGP4+ peering relationship.

Syntax `neighbor <neighborid> remote-as <as-number>`
`no neighbor <neighborid> remote-as <as-number>`

Syntax (VRF- lite) `neighbor <neighborid> remote-as <as-number> [global|vrf <vrf-name>]`
`no neighbor <neighborid> remote-as <as-number>`

Parameter	Description
<neighborid>	{<ip-address> ipv6-addr <peer-group>}
<ip-address>	Specify the address of an IPv4 BGP neighbor, in dotted decimal notation A.B.C.D.
<ipv6-addr>	Specify the address of an IPv6 BGP4+ neighbor, entered in hexadecimal in the format X:X::X:X.
<peer-group>	Enter the name of an existing peer-group. For information on how to create peer groups, refer to the neighbor peer-group (add a neighbor) command, and neighbor route-map command. When this parameter is used with this command, the command applies on all peers in the specified group.
<as-number>	<1-4294967295> Neighbor's Autonomous System (AS) number.
global	Specify that the remote neighbor exists locally within the device, in the global routing domain
vrf	Specify that the remote neighbor exists locally within the device, in the specified VRF instance.
<vrf-name>	The name of the VRF instance.

Mode [BGP] Router Configuration or IPv4 Address Family Configuration

Mode [BGP4+] Router Configuration

Usage notes This command is used to configure iBGP and eBGP peering relationships with other BGP or BGP4+ neighbors. A peer-group support of this command is configured only after creating a specific peer-group. Use the **no** variant of this command to remove a previously configured BGP peering relationship.

The **vrf** and **global** parameters are used to create internal 'loopback' BGP connections within the device between two VRF instances. This is used to leak BGP routes between a named VRF instance and the global routing instance. This requires BGP neighbors to be configured in both the global routing instance and in the named VRF instance.

Examples [BGP] To configure a BGP peering relationship from the neighbor with the IPv4 address 10.10.0.73 with another router:

```
awplus# configure terminal
awplus(config)# router bgp 10
awplus(config-router)# neighbor 10.10.0.73 remote-as 10
```

To remove a configured BGP peering relationship from the neighbor with the IPv4 address 10.10.0.73 from another router:

```
awplus# configure terminal
awplus(config)# router bgp 10
awplus(config-router)# no neighbor 10.10.0.73 remote-as 10
```

To configure a BGP peering relationship from the neighbor with the peer group named group1 with another router:

```
awplus# configure terminal
awplus(config)# router bgp 10
awplus(config-router)# neighbor group1 peer-group
awplus(config-router)# neighbor 10.10.10.1 remote-as 10
awplus(config-router)# neighbor 10.10.10.1 peer-group group1
awplus(config-router)# neighbor group1 remote-as 10
```

To remove a configured BGP peering relationship from the neighbor with the peer group named group1 with another router:

```
awplus# configure terminal
awplus(config)# router bgp 10
awplus(config-router)# no neighbor group1 remote-as 10
```

Examples [BGP4+] To configure a BGP4+ peering relationship with another router:

```
awplus# configure terminal
awplus(config)# router bgp 11
awplus(config-router)# neighbor 2001:0db8:010d::1 remote-as 345
```

To remove a configured BGP4+ peering relationship from another router:

```
awplus# configure terminal
awplus(config)# router bgp 11
awplus(config-router)# no neighbor 2001:0db8:010d::1 remote-as 345
```

To configure a BGP4+ peering relationship from the neighbor with the peer group named group1 with another router:

```
awplus# configure terminal
awplus(config)# router bgp 10
awplus(config-router)# neighbor group1 peer-group
awplus(config-router)# neighbor 2001:0db8:010d::1 remote-as 10
awplus(config-router)# address-family ipv6
awplus(config-router-af)# neighbor 2001:0db8:010d::1
peer-group group1
awplus(config-router-af)# exit
awplus(config-router)# neighbor group1 remote-as 10
```

To remove a configured BGP4+ peering relationship from the neighbor with the peer group named group1 with another router:

```
awplus# configure terminal
awplus(config)# router bgp 10
awplus(config-router)# no neighbor group1 remote-as 10
```

**Command
changes**

Added to AlliedWare Plus prior to 5.4.6-1

Version 5.4.6-2.1: VRF-lite support added to BGP for AR-series products

Version 5.4.7-2.1: BGP support added for IEx510, x550 series

Version 5.4.7-2.4: BGP support added for IE300 series

neighbor remove-private-AS (BGP only)

Overview Use this command to remove the private Autonomous System (AS) number from external outbound updates. Use the **no** variant of this command to revert to the default (disabled).

Syntax `neighbor <neighborid> remove-private-AS`
`no neighbor <neighborid> remove-private-AS`

Parameter	Description
<neighborid>	{ <ip-address> <tag> }
<ip-address>	The address of an IPv4 BGP neighbor, in dotted decimal notation A.B.C.D.
<tag>	Name of an existing peer-group. For information on how to create peer groups, refer to the neighbor peer-group (add a neighbor) command, and neighbor remote-as command. When this parameter is used with a command, the command applies on all peers in the specified group.

Default This command is disabled by default.

Mode Router Configuration or IPv4 Address Family Configuration

Usage notes The private AS numbers range from <64512-65535>. Private AS numbers are not advertised to the Internet. This command is used with external BGP peers only. The router removes the AS numbers only if the update includes private AS numbers. If the update includes both private and public AS numbers, the system treats it as an error.

This command removes private AS numbers for BGP in Router Configuration mode. This command is not supported for BGP4+ in IPv6 Address Family Configuration mode. This command removes a private AS number and makes an update packet with a public AS number as the AS path attribute. So only public AS numbers are entered in Internet BGP routing tables, and private AS numbers are not entered in Internet BGP tables.

For the filtering to apply, both peering devices must be set to use either 2-byte or extended 4- byte ASN (with the same ASN type set on both peers). For example, if a device (which defaults to use a 4-byte ASN), is peered with a device that defaults to a 2-byte ASN, then the device using a 2-byte ASN device also needs to be configured with the command **bgp extended-asn-cap** for the filtering to apply.

Examples

```
awplus# configure terminal
awplus(config)# router bgp 10
awplus(config-router)# neighbor 10.10.0.63 remove-private-AS
awplus# configure terminal
awplus(config)# router bgp 10
awplus(config-router)# no neighbor 10.10.0.63 remove-private-AS
```

Related commands [show ip bgp \(BGP only\)](#)

Command changes

- Added to AlliedWare Plus prior to 5.4.6-1
- Version 5.4.7-2.1: BGP support added for IEx510, x550 series
- Version 5.4.7-2.4: BGP support added for IE300 series

neighbor restart-time

Overview Use this command to set a different restart-time other than the global restart-time configured using the **bgp graceful-restart** command for BGP and BGP4+.

Use the **no** variant of this command to restore the device to its default state (see the default value of the **bgp graceful-restart** command).

Syntax `neighbor <neighborid> restart-time <delay-value>`
`no neighbor <neighborid> restart-time <delay-value>`

Parameter	Description
<code><neighborid></code>	{ <code><ip-address></code> <code><ipv6-addr></code> <code><peer-group></code> }
<code><ip-address></code>	Specify the address of an IPv4 BGP neighbor, in dotted decimal notation A.B.C.D.
<code><ipv6-addr></code>	Specify the address of an IPv6 BGP4+ neighbor, entered in hexadecimal in the format X:X::X:X.
<code><peer-group></code>	Enter the name of an existing peer-group. For information on how to create peer groups, refer to the neighbor peer-group (add a neighbor) command, and neighbor route-map command. When this parameter is used with this command, the command applies on all peers in the specified group.
<code><delay-value></code>	<code><1-3600></code> Delay value in seconds.

Mode [BGP] Router Configuration or IPv4 Address Family Configuration

Mode [BGP4+] Router Configuration

Usage This command takes precedence over the restart-time value specified using the **bgp graceful-restart** command.

The restart-time value is the maximum time that a graceful-restart neighbor waits to come back up after a restart. The default is 120 seconds.

Make sure that the restart time specified using this command does not exceed the stalepath-time specified in the Router Configuration mode.

Examples [BGP]

```
awplus# configure terminal
awplus(config)# router bgp 10
awplus(config-router)# neighbor 10.10.10.1 restart-time 45
awplus# configure terminal
awplus(config)# router bgp 10
awplus(config-router)# no neighbor 10.10.10.1 restart-time 45
awplus# configure terminal
awplus(config)# router bgp 10
awplus(config-router)# neighbor group1 peer-group
awplus(config-router)# neighbor 10.10.10.1 remote-as 10
awplus(config-router)# neighbor 10.10.10.1 peer-group group1
awplus(config-router)# neighbor group1 restart-time 45
awplus# configure terminal
awplus(config)# router bgp 10
awplus(config-router)# no neighbor group1 restart-time 45
```

Examples [BGP4+]

```
awplus# configure terminal
awplus(config)# router bgp 10
awplus(config-router)# neighbor 2001:0db8:010d::1 restart-time 45
awplus# configure terminal
awplus(config)# router bgp 10
awplus(config-router)# no neighbor 2001:0db8:010d::1 restart-time 45
awplus# configure terminal
awplus(config)# router bgp 10
awplus(config-router)# neighbor group1 peer-group
awplus(config-router)# neighbor 2001:0db8:010d::1 remote-as 10
awplus(config-router)# address-family ipv6
awplus(config-router-af)# neighbor 2001:0db8:010d::1 peer-group group1
awplus(config-router-af)# exit
awplus(config-router)# neighbor group1 restart-time 45
awplus# configure terminal
awplus(config)# router bgp 10
awplus(config-router)# no neighbor group1 restart-time 45
```

Related commands

- [bgp graceful-restart](#)
- [neighbor peer-group \(add a neighbor\)](#)
- [neighbor route-map](#)

- Command changes**
- Added to AlliedWare Plus prior to 5.4.6-1
 - Version 5.4.7-2.1: BGP support added for IEx510, x550 series
 - Version 5.4.7-2.4: BGP support added for IE300 series

neighbor route-map

Overview Use this command to apply a route map to incoming or outgoing routes for BGP or BGP4+.

Use the **no** variant of this command to remove a route map from a BGP or BGP4+ route.

Syntax `neighbor <neighborid> route-map <mapname> {in|out}`
`no neighbor <neighborid> route-map <mapname> {in|out}`

Parameter	Description
<neighborid>	{<ip-address> ipv6-addr> <peer-group>}
<ip-address>	Specify the address of an IPv4 BGP neighbor, in dotted decimal notation A.B.C.D.
<ipv6-addr>	Specify the address of an IPv6 BGP4+ neighbor, entered in hexadecimal in the format X:X::X:X.
<peer-group>	Enter the name of an existing peer-group. For information on how to create peer groups, refer to the neighbor peer-group (add a neighbor) command, and neighbor route-map command. When this parameter is used with this command, the command applies on all peers in the specified group.
<mapname>	Specifies name of the route-map.
in	Specifies that the access list applies to incoming advertisements.
out	Specifies that the access list applies to outgoing advertisements.

Mode [BGP] Router Configuration or IPv4 Address Family Configuration

Mode [BGP4+] IPv6 Address Family Configuration

Usage notes Use the **neighbor route-map** command to filter updates and modify attributes. A route map is applied to inbound or outbound updates. Only the routes that pass the route map are sent or accepted in updates.

Examples [BGP] The following example shows the configuration of the route-map name **rmap2** and then the use of this map name in the **neighbor route-map** command for the neighbor with the IPv4 address 10.10.10.1 in the Router Configuration mode.

```
awplus# configure terminal
awplus(config)# route-map rmap2 permit 6
awplus(config-route-map)# match origin incomplete
awplus(config-route-map)# set metric 100
awplus(config-route-map)# exit
awplus(config)# router bgp 10
awplus(config-router)# neighbor 10.10.10.1 route-map rmap2 in
```

The following example shows the removal of the route-map name **rmap2** in the **neighbor route-map** command for the neighbor with the IPv4 address 10.10.10.1 in the Router Configuration mode.

```
awplus# configure terminal
awplus(config)# router bgp 10
awplus(config-router)# no neighbor 10.10.10.1 route-map rmap2
in
```

The following example shows the configuration of the route-map name **rmap2** and then the use of this map name in the **neighbor route-map** command for the neighbor with the IPv4 address 10.10.10.1 in the IPv4 Address Family Configuration mode.

```
awplus# configure terminal
awplus(config)# route-map rmap2 permit 6
awplus(config-route-map)# match origin incomplete
awplus(config-route-map)# set metric 100
awplus(config-route-map)# exit
awplus(config)# router bgp 10
awplus(config-router)# address-family ipv4
awplus(config-router-af)# neighbor 10.10.10.1 route-map rmap2
in
```

The following example shows the removal of the route-map name **rmap2** in the **neighbor route-map** command for the neighbor with the IPv4 address 10.10.10.1 in the IPv4 Address Family Configuration mode.

```
awplus# configure terminal
awplus(config)# router bgp 10
awplus(config-router)# address-family ipv4
awplus(config-router-af)# no neighbor 10.10.10.1 route-map
rmap2 in
```

The following example shows the configuration of the route-map name **rmap2** and then the use of this map name in the **neighbor route-map** command for the neighbor with the peer group named group1 in the Router Configuration mode.

```
awplus# configure terminal
awplus(config)# route-map rmap2 permit 6
awplus(config-route-map)# match origin incomplete
awplus(config-route-map)# set metric 100
awplus(config-route-map)# exit
awplus(config)# router bgp 10
awplus(config-router)# neighbor group1 peer-group
awplus(config-router)# neighbor 10.10.10.1 remote-as 10
awplus(config-router)# neighbor 10.10.10.1 peer-group group1
awplus(config-router)# neighbor group1 route-map rmap2 in
```

The following example shows the removal the route-map name **rmap2** in the **neighbor route-map** command for the neighbor with the peer group named group1 in the Router Configuration mode.

```
awplus# configure terminal
awplus(config)# router bgp 10
awplus(config-router)# no neighbor group1 route-map rmap2 in
```

Examples
[BGP4+]

The following example shows the configuration of the route-map name **rmap2** and then the use of this map name in the **neighbor route-map** command for the neighbor with the IPv6 address 2001:0db8:010d::1 in the IPv6 Address Family Configuration mode.

```
awplus# configure terminal
awplus(config)# route-map rmap2 permit 6
awplus(config-route-map)# match origin incomplete
awplus(config-route-map)# set metric 100
awplus(config-route-map)# exit
awplus(config)# router bgp 10
awplus(config-router)# address-family ipv6
awplus(config-router-af)# neighbor 2001:0db8:010d::1 route-map
rmap2 in
```

The following example shows the removal of the route-map name **rmap2** in the **neighbor route-map** command for the neighbor with the IPv6 address 2001:0db8:010d::1 in the IPv6 Address Family Configuration mode.

```
awplus# configure terminal
awplus(config)# router bgp 10
awplus(config-router)# address-family ipv6
awplus(config-router-af)# no neighbor 2001:0db8:010d::1
route-map rmap2 in
```

The following example shows the configuration of the route-map name **rmap2** and then the use of this map name in the **neighbor route-map** command for the neighbor with the peer group named group1 in the Router Configuration mode.

```
awplus# configure terminal
awplus(config)# route-map rmap2 permit 6
awplus(config-route-map)# match origin incomplete
awplus(config-route-map)# set metric 100
awplus(config-route-map)# exit
awplus(config)# router bgp 10
awplus(config-router)# neighbor group1 peer-group
awplus(config-router)# neighbor 2001:0db8:010d::1 remote-as 10
awplus(config-router)# address-family ipv6
awplus(config-router-af)# neighbor 2001:0db8:010d::1
peer-group group1
awplus(config-router-af)# neighbor group1 route-map rmap2 in
```

The following example shows the removal the route-map name **rmap2** in the **neighbor route-map** command for the neighbor with the peer group named group1 in the Router Configuration mode.

```
awplus# configure terminal
awplus(config)# router bgp 10
awplus(config-router)# address-family ipv6
awplus(config-router-af)# no neighbor group1 route-map rmap2 in
```

**Related
commands**

[address-family](#)
[neighbor peer-group \(add a neighbor\)](#)
[route-map](#)

**Command
changes**

Added to AlliedWare Plus prior to 5.4.6-1
Version 5.4.7-2.1: BGP support added for IEx510, x550 series
Version 5.4.7-2.4: BGP support added for IE300 series

neighbor route-reflector-client (BGP only)

Overview Use this command to configure the router as a BGP route reflector and configure the specified neighbor as its client.

Use the **no** variant of this command to indicate that the neighbor is not a client.

Syntax `neighbor <neighborid> route-reflector-client`
`no neighbor <neighborid> route-reflector-client`

Parameter	Description
<neighborid>	{ <ip-address> <peer-group> }
<ip-address>	The address of an IPv4 BGP neighbor, in dotted decimal notation A.B.C.D.
<peer-group>	Enter the name of an existing peer-group. For information on how to create peer groups, refer to the neighbor peer-group (add a neighbor) command, and neighbor route-map command. When this parameter is used with this command, the command applies on all peers in the specified group.

Mode Router Configuration or IPv4 Address Family Configuration

Usage notes Route reflectors are a solution for the explosion of iBGP peering within an autonomous system. By route reflection the number of iBGP peers within an AS is reduced. Use the **neighbor route-reflector-client** command to configure the local router as the route reflector and specify neighbors as its client.

An AS can have more than one route reflector. One route reflector treats the other route reflector as another iBGP speaker.

In the following configuration, Router1 is the route reflector for clients 3.3.3.3 and 2.2.2.2; it also has a non-client peer 6.6.6.6:

```
Router1#  
router bgp 200  
neighbor 3.3.3.3 remote-as 200  
neighbor 3.3.3.3 route-reflector-client  
neighbor 2.2.2.2 remote-as 200  
neighbor 2.2.2.2 route-reflector-client  
neighbor 6.6.6.6 remote-as 200
```

Examples

```
awplus# configure terminal
awplus(config)# router bgp 10
awplus(config-router)# neighbor 10.10.0.72
route-reflector-client

awplus# configure terminal
awplus(config)# router bgp 10
awplus(config-router)# no neighbor 10.10.0.72
route-reflector-client
```

Command changes

- Added to AlliedWare Plus prior to 5.4.6-1
- Version 5.4.7-2.1: BGP support added for IEx510, x550 series
- Version 5.4.7-2.4: BGP support added for IE300 series

neighbor route-server-client (BGP only)

Overview Use this command to specify the peer as route server client.
Use the **no** variant of this command to disable this function.

Syntax neighbor <neighborid> route-server-client
no neighbor <neighborid> route-server-client

Parameter	Description
<neighborid>	{<ip-address> <peer-group>}
<ip-address>	The address of an IPv4 BGP neighbor, in dotted decimal notation A.B.C.D.
<peer-group>	Enter the name of an existing peer-group. For information on how to create peer groups, refer to the neighbor peer-group (add a neighbor) command, and neighbor route-map command. When this parameter is used with this command, the command applies on all peers in the specified group.

Mode Router Configuration

Examples

```
awplus# configure terminal
awplus(config)# router bgp 10
awplus(config-router)# neighbor 10.10.0.72 route-server-client
awplus# configure terminal
awplus(config)# router bgp 10
awplus(config-router)# no neighbor 10.10.0.72
route-server-client
```

Command changes Added to AlliedWare Plus prior to 5.4.6-1
Version 5.4.7-2.1: BGP support added for IEx510, x550 series
Version 5.4.7-2.4: BGP support added for IE300 series

neighbor send-community

Overview Use this command to specify that a community attribute should be sent to a BGP or BGP4+ neighbor.

Use the **no** variant of this command to remove the entry for the community attribute.

Syntax `neighbor <neighborid> send-community {both|extended|standard}`
`no neighbor <neighborid> send-community {both|extended|standard}`

Parameter	Description
<neighborid>	{<ip-address> <ipv6-addr> <peer-group>}
<ip-address>	Specify the address of an IPv4 BGP neighbor, in dotted decimal notation A.B.C.D.
<ipv6-addr>	Specify the address of an IPv6 BGP4+ neighbor, entered in hexadecimal in the format X:X::X:X.
<peer-group>	Enter the name of an existing peer-group. For information on how to create peer groups, refer to the neighbor peer-group (add a neighbor) command, and neighbor route-map command. When this parameter is used with this command, the command applies on all peers in the specified group.
both	Sends Standard and Extended Community attributes. Specifying this parameter with the no variant of this command results in no standard or extended community attributes being sent.
extended	Sends Extended Community attributes. Specifying this parameter with the no variant of this command results in no extended community attributes being sent.
standard	Sends Standard Community attributes. Specifying this parameter with the no variant of this command results in no standard community attributes being sent.

Default Both **standard** and **extended** community attributes are sent to a neighbor.

Mode [BGP] Router Configuration or IPv4 Address Family Configuration

Mode [BGP4+] Router Configuration and IPv6 Address Family Configuration

Usage notes This command is used to specify a community attribute to be sent to a neighbor. The community attribute groups destinations in a certain community and applies routing decisions according to those communities. On receiving community attributes the router reannounces them to the neighbor. Only when the **no**

parameter is used with this command the community attributes are not reannounced to the neighbor.

By default, both **standard** and **extended** community attributes are sent to a neighbor.

Examples [BGP]

```
awplus# configure terminal
awplus(config)# bgp config-type standard
awplus(config)# router bgp 10
awplus(config-router)# neighbor 10.10.0.72 send-community
extended

awplus# configure terminal
awplus(config)# bgp config-type standard
awplus(config)# router bgp 10
awplus(config-router)# no neighbor 10.10.0.72 send-community
extended

awplus# configure terminal
awplus(config)# bgp config-type standard
awplus(config)# router bgp 10
awplus(config-router)# address-family ipv4
awplus(config-router-af)# neighbor 10.10.0.72 send-community
extended

awplus# configure terminal
awplus(config)# bgp config-type standard
awplus(config)# router bgp 10
awplus(config-router)# address-family ipv4
awplus(config-router-af)# no neighbor 10.10.0.72 send-community
extended

awplus# configure terminal
awplus(config)# bgp config-type standard
awplus(config)# router bgp 10
awplus(config-router)# neighbor group1 peer-group
awplus(config-router)# neighbor 10.10.10.1 remote-as 10
awplus(config-router)# neighbor 10.10.10.1 peer-group group1
awplus(config-router)# neighbor group1 send-community extended
```

Examples
[BGP4+]

```
awplus# configure terminal
awplus(config)# bgp config-type standard
awplus(config)# router bgp 10
awplus(config-router)# neighbor 2001:0db8:010d::1
send-community extended
awplus# configure terminal
awplus(config)# bgp config-type standard
awplus(config)# router bgp 10
awplus(config-router)# no neighbor 2001:0db8:010d::1
send-community extended
awplus# configure terminal
awplus(config)# bgp config-type standard
awplus(config)# router bgp 10
awplus(config-router)# address-family ipv6
awplus(config-router-af)# neighbor 2001:0db8:010d::1
send-community extended
awplus# configure terminal
awplus(config)# bgp config-type standard
awplus(config)# router bgp 10
awplus(config-router)# address-family ipv6
awplus(config-router-af)# no neighbor 2001:0db8:010d::1
send-community extended
awplus# configure terminal
awplus(config)# bgp config-type standard
awplus(config)# router bgp 10
awplus(config-router)# neighbor group1 peer-group
awplus(config-router)# neighbor 2001:0db8:010d::1 remote-as 10
awplus(config-router)# address-family ipv6
awplus(config-router-af)# neighbor 2001:0db8:010d::1
peer-group group1
awplus(config-router-af)# exit
awplus(config-router)# neighbor group1 send-community extended
awplus# configure terminal
awplus(config)# bgp config-type standard
awplus(config)# router bgp 10
awplus(config-router)# no neighbor group1 send-community
extended
```

Related commands

- [bgp config-type](#)
- [neighbor peer-group \(add a neighbor\)](#)
- [neighbor route-map](#)

Command changes Added to AlliedWare Plus prior to 5.4.6-1
Version 5.4.7-2.1: BGP support added for IEx510, x550 series
Version 5.4.7-2.4: BGP support added for IE300 series

neighbor shutdown

Overview Use this command to disable a peering relationship with a BGP or BGP4+ neighbor. Use the **no** variant of this command to re-enable the BGP or BGP4+ neighbor.

Syntax neighbor <neighborid> shutdown
no neighbor <neighborid> shutdown

Parameter	Description
<neighborid>	{ <ip-address> <peer-group> }
<ip-address>	Specify the address of an IPv4 BGP neighbor, in dotted decimal notation A.B.C.D.
<ipv6-addr>	Specify the address of an IPv6 BGP4+ neighbor, entered in hexadecimal in the format X:X::X:X.
<peer-group>	Enter the name of an existing peer-group. For information on how to create peer groups, refer to the neighbor peer-group (add a neighbor) command, and neighbor route-map command. When this parameter is used with this command, the command applies on all peers in the specified group.

Mode [BGP] Router Configuration or IPv4 Address Family Configuration

Mode [BGP4+] Router Configuration

Usage notes This command shuts down any active session for the specified BGP or BGP4+ neighbor and clears all related routing data.

Examples [BGP]

```
awplus# configure terminal
awplus(config)# router bgp 10
awplus(config-router)# neighbor 10.10.0.72 shutdown
awplus# configure terminal
awplus(config)# router bgp 10
awplus(config-router)# no neighbor 10.10.0.72 shutdown
awplus# configure terminal
awplus(config)# router bgp 10
awplus(config-router)# neighbor group1 shutdown
awplus# configure terminal
awplus(config)# router bgp 10
awplus(config-router)# no neighbor group1 shutdown
```

Examples
[BGP4+]

```
awplus# configure terminal
awplus(config)# router bgp 10
awplus(config-router)# neighbor 2001:0db8:010d::1 shutdown
awplus# configure terminal
awplus(config)# router bgp 10
awplus(config-router)# no neighbor 2001:0db8:010d::1 shutdown
awplus# configure terminal
awplus(config)# router bgp 10
awplus(config-router)# neighbor group1 shutdown
awplus# configure terminal
awplus(config)# router bgp 10
awplus(config-router)# no neighbor group1 shutdown
```

Related commands [neighbor peer-group \(add a neighbor\)](#)
[neighbor route-map](#)

Command changes Added to AlliedWare Plus prior to 5.4.6-1
Version 5.4.7-2.1: BGP support added for IEx510, x550 series
Version 5.4.7-2.4: BGP support added for IE300 series

neighbor soft-reconfiguration inbound

Overview Use this command to configure the device to start storing all updates from the BGP or BGP4+ neighbor, without any consideration of any inward route filtering policy that might be applied to the connection with this BGP or BGP4+ neighbor. This is so that the full set of the neighbor's updates are available locally to be used in a soft-reconfiguration event.

You may need to apply this older method of clearing routes if the peer does not support route refresh.

Use the **no** variant of this command to disable this function for a BGP or BGP4+ neighbor.

Syntax `neighbor <neighborid> soft-reconfiguration inbound`
`no neighbor <neighborid> soft-reconfiguration inbound`

Parameter	Description
<neighborid>	{<ip-address> <ipv6-addr> <peer-group>}
<ip-address>	Specify the address of an IPv4 BGP neighbor, in dotted decimal notation A.B.C.D.
<ipv6-addr>	Specify the address of an IPv6 BGP4+ neighbor, entered in hexadecimal in the format X:X::X:X.
<peer-group>	Enter the name of an existing peer-group. For information on how to create peer groups, refer to the neighbor peer-group (add a neighbor) command, and neighbor route-map command. When this parameter is used with this command, the command applies on all peers in the specified group.

Mode [BGP] Router Configuration or IPv4 Address Family Configuration

Mode [BGP4+] IPv6 Address Family Configuration

Usage Use this command to store updates for inbound soft reconfiguration. Soft-reconfiguration may be used in lieu of BGP route refresh capability. Using this command enables local storage of all the received routes and their attributes. This requires additional memory. When a soft reset (inbound) is done on this neighbor, the locally stored routes are re-processed according to the inbound policy. The BGP neighbor connection is not affected.

Examples [BGP]

```
awplus# configure terminal
awplus(config)# router bgp 12
awplus(config-router)# neighbor 10.10.10.10
soft-reconfiguration inbound
awplus# configure terminal
awplus(config)# router bgp 12
awplus(config-router)# no neighbor 10.10.10.10
soft-reconfiguration inbound
awplus# configure terminal
awplus(config)# router bgp 12
awplus(config-router)# address-family ipv4
awplus(config-router-af)# neighbor 10.10.10.10 soft-reconfiguration inbound
awplus# configure terminal
awplus(config)# router bgp 12
awplus(config-router)# address-family ipv4
awplus(config-router-af)# no neighbor 10.10.10.10 soft-reconfiguration inbound
awplus# configure terminal
awplus(config)# router bgp 10
awplus(config-router)# neighbor group1 peer-group
awplus(config-router)# neighbor 10.10.10.1 remote-as 10
awplus(config-router)# neighbor 10.10.10.1 peer-group group1
awplus(config-router)# neighbor group1 soft-reconfiguration
inbound
awplus# configure terminal
awplus(config)# router bgp 12
awplus(config-router)# no neighbor group1 soft-reconfiguration
inbound
```

Examples
[BGP4+]

```
awplus# configure terminal
awplus(config)# router bgp 12
awplus(config-router)# address-family ipv6
awplus(config-router-af)# neighbor 2001:0db8:010d::1
soft-reconfiguration inbound
awplus# configure terminal
awplus(config)# router bgp 12
awplus(config-router)# address-family ipv6
awplus(config-router-af)# no neighbor 2001:0db8:010d::1
soft-reconfiguration inbound
awplus# configure terminal
awplus(config)# router bgp 10
awplus(config-router)# neighbor group1 peer-group
awplus(config-router)# neighbor 2001:0db8:010d::1 remote-as 10
awplus(config-router)# address-family ipv6
awplus(config-router-af)# neighbor 2001:0db8:010d::1
peer-group group1
awplus(config-router-af)# neighbor group1 soft-reconfiguration
inbound
awplus# configure terminal
awplus(config)# router bgp 12
awplus(config-router)# address-family ipv6
awplus(config-router-
af)# no neighbor group1 soft-reconfiguration inbound
```

Related commands [neighbor peer-group \(add a neighbor\)](#)
[neighbor route-map](#)

Command changes Added to AlliedWare Plus prior to 5.4.6-1
Version 5.4.7-2.1: BGP support added for IEx510, x550 series
Version 5.4.7-2.4: BGP support added for IE300 series

neighbor timers

Overview Use this command to set the keepalive, holdtime, and connect timers for a specific BGP or BGP4+ neighbor.

Use the **no** variant of this command to clear the timers for a specific BGP or BGP4+ neighbor.

Syntax `neighbor <neighborid> timers {<keepalive> <holdtime>|connect <connect>}`

`no neighbor <neighborid> timers [connect]`

Parameter	Description
<code><neighborid></code>	<code>{<ip-address> <ipv6-addr> <peer-group>}</code>
<code><ip-address></code>	Specify the address of an IPv4 BGP neighbor, in dotted decimal notation A.B.C.D.
<code><ipv6-addr></code>	Specify the address of an IPv6 BGP4+ neighbor, entered in hexadecimal in the format X:X::X:X.
<code><peer-group></code>	Enter the name of an existing peer-group. For information on how to create peer groups, refer to the neighbor peer-group (add a neighbor) command, and neighbor route-map command. When this parameter is used with this command, the command applies on all peers in the specified group.
<code><keepalive></code>	<code><0-65535></code> Frequency (in seconds) at which a router sends keepalive messages to its neighbor.
<code><holdtime></code>	<code><0-65535></code> Interval (in seconds) after which, on not receiving a keepalive message, the router declares a neighbor dead.
<code><connect></code>	<code>connect <1-65535></code> Specifies the connect timer in seconds. The default connect timer value is 120 seconds as per RFC 4271. Modify this value as needed for interoperability.

Default The keepalive timer default is 60 seconds, the holdtime timer default is 90 seconds, and the connect timer default is 120 seconds as per RFC 4271. Holdtime is `keepalive * 3`.

Mode [BGP] Router Configuration or IPv4 Address Family Configuration

Mode [BGP4+] Router Configuration

Usage Keepalive messages are sent by a router to inform another router that the BGP connection between the two is still active. The keepalive interval is the period of time between each keepalive message sent by the router. The holdtime interval is the time the router waits to receive a keepalive message and if it does not receive

a message for this period it declares the neighbor dead. The holdtime value must be 3 times the value of the keepalive value.

Examples [BGP]

```
awplus# configure terminal
awplus(config)# router bgp 10
awplus(config-router)# neighbor 10.10.10.1 timers 60 120
awplus# configure terminal
awplus(config)# router bgp 10
awplus(config-router)# no neighbor 10.10.10.1 timers
awplus# configure terminal
awplus(config)# router bgp 10
awplus(config-router)# neighbor group1 peer-group
awplus(config-router)# neighbor 10.10.10.1 remote-as 10
awplus(config-router)# neighbor 10.10.10.1 peer-group group1
awplus(config-router)# neighbor group1 timers 60 120
awplus# configure terminal
awplus(config)# router bgp 10
awplus(config-router)# no neighbor group1 timers
```

Examples [BGP4+]

```
awplus# configure terminal
awplus(config)# router bgp 10
awplus(config-router)# neighbor 2001:0db8:010d::1 timers 60 120
awplus# configure terminal
awplus(config)# router bgp 10
awplus(config-router)# no neighbor 2001:0db8:010d::1 timers
awplus# configure terminal
awplus(config)# router bgp 10
awplus(config-router)# neighbor group1 peer-group
awplus(config-router)# neighbor 2001:0db8:010d::1 remote-as 10
awplus(config-router)# address-family ipv6
awplus(config-router-af)# neighbor 2001:0db8:010d::1
peer-group group1
awplus(config-router-af)# exit
awplus(config-router)# neighbor group1 timers 60 120
awplus# configure terminal
awplus(config)# router bgp 10
awplus(config-router)# no neighbor group1 timers
```

Related commands neighbor peer-group (add a neighbor)
neighbor route-map
show ip bgp neighbors hold-time (BGP only)
show ip bgp neighbors keepalive-interval (BGP only)
timers (BGP)

Command changes Added to AlliedWare Plus prior to 5.4.6-1
Version 5.4.7-2.1: BGP support added for IEx510, x550 series
Version 5.4.7-2.4: BGP support added for IE300 series

neighbor transparent-as

Overview Use this command to specify not to append your AS path number even if the BGP or BGP4+ peer is an eBGP peer.

Note this command has the same effect as invoking [neighbor attribute-unchanged](#) and specifying the optional **as-path** parameter.

Syntax neighbor <neighborid> transparent-as

Parameter	Description
<neighborid>	{<ip-address> <ipv6-addr> <peer-group>}
<ip-address>	Specify the address of an IPv4 BGP neighbor, in dotted decimal notation A.B.C.D.
<ipv6-addr>	Specify the address of an IPv6 BGP4+ neighbor, entered in hexadecimal in the format X:X::X:X.
<peer-group>	Enter the name of an existing peer-group. For information on how to create peer groups, refer to the neighbor peer-group (add a neighbor) command, and neighbor route-map command. When this parameter is used with this command, the command applies on all peers in the specified group.

Mode Router Configuration

Examples [BGP]

```
awplus# configure terminal
awplus(config)# router bgp 10
awplus(config-router)# neighbor 10.10.10.1 transparent-as
awplus# configure terminal
awplus(config)# router bgp 10
awplus(config-router)# neighbor group1 peer-group
awplus(config-router)# neighbor 10.10.10.1 remote-as 10
awplus(config-router)# neighbor 10.10.10.1 peer-group group1
awplus(config-router)# neighbor group1 transparent-as
```

Examples
[BGP4+]

```
awplus# configure terminal
awplus(config)# router bgp 10
awplus(config-router)# neighbor 2001:0db8:010d::1
transparent-as
awplus# configure terminal
awplus(config)# router bgp 10
awplus(config-router)# neighbor group1 peer-group
awplus(config-router)# neighbor 2001:0db8:010d::1 remote-as 10
awplus(config-router)# address-family ipv6
awplus(config-router-af)# neighbor 2001:0db8:010d::1
peer-group group1
awplus(config-router-af)# exit
awplus(config-router)# neighbor group1 transparent-as
```

Related commands

- [neighbor attribute-unchanged](#)
- [neighbor peer-group \(add a neighbor\)](#)
- [neighbor route-map](#)
- [neighbor transparent-nexthop](#)

Command changes

- Added to AlliedWare Plus prior to 5.4.6-1
- Version 5.4.7-2.1: BGP support added for IEx510, x550 series
- Version 5.4.7-2.4: BGP support added for IE300 series

neighbor transparent-nextthop

Overview Use this command to keep the next hop value of the route even if the BGP or BGP4+ peer is an eBGP peer.

Note this command has the same effect as invoking [neighbor attribute-unchanged](#) and specifying the optional **next-hop** parameter.

Syntax `neighbor <neighborid> transparent-nextthop`

Parameter	Description
<neighborid>	{<ip-address> <ipv6-addr> <peer-group>}
<ip-address>	Specify the address of an IPv4 BGP neighbor, in dotted decimal notation A.B.C.D.
<ipv6-addr>	Specify the address of an IPv6 BGP4+ neighbor, entered in hexadecimal in the format X:X::X:X.
<peer-group>	Enter the name of an existing peer-group. For information on how to create peer groups, refer to the neighbor peer-group (add a neighbor) command, and neighbor route-map command. When this parameter is used with this command, the command applies on all peers in the specified group.

Mode Router Configuration

Examples [BGP]

```
awplus# configure terminal
awplus(config)# router bgp 10
awplus(config-router)# neighbor 10.10.10.1 transparent-nextthop
awplus# configure terminal
awplus(config)# router bgp 10
awplus(config-router)# neighbor group1 peer-group
awplus(config-router)# neighbor 10.10.10.1 remote-as 10
awplus(config-router)# neighbor 10.10.10.1 peer-group group1
awplus(config-router)# neighbor group1 transparent-nextthop
```

Examples
[BGP4+]

```
awplus# configure terminal
awplus(config)# router bgp 10
awplus(config-router)# neighbor 2001:0db8:010d::1
transparent-nexthop
awplus# configure terminal
awplus(config)# router bgp 10
awplus(config-router)# neighbor group1 peer-group
awplus(config-router)# neighbor 2001:0db8:010d::1 remote-as 10
awplus(config-router)# address-family ipv6
awplus(config-router-af)# neighbor 2001:0db8:010d::1
peer-group group1
awplus(config-router-af)# exit
awplus(config-router)# neighbor group1 transparent-nexthop
```

Related commands

- [neighbor attribute-unchanged](#)
- [neighbor peer-group \(add a neighbor\)](#)
- [neighbor route-map](#)
- [neighbor transparent-as](#)

Command changes

- Added to AlliedWare Plus prior to 5.4.6-1
- Version 5.4.7-2.1: BGP support added for IEx510, x550 series
- Version 5.4.7-2.4: BGP support added for IE300 series

neighbor unsuppress-map

Overview Use this command to selectively leak more specific routes to a particular BGP or BGP4+ neighbor.

Use the **no** variant of this command to remove selectively leaked specific routes to a particular BGP or BGP4+ neighbor.

Syntax `neighbor <neighborid> unsuppress-map <route-map-name>`
`no neighbor <neighborid> unsuppress-map <route-map-name>`

Parameter	Description
<neighborid>	{ <ip-address> <ipv6-addr> <peer-group> }
<ip-address>	Specify the address of an IPv4 BGP neighbor, in dotted decimal notation A.B.C.D.
<ipv6-addr>	Specify the address of an IPv6 BGP4+ neighbor, entered in hexadecimal in the format X:X::X:X.
<peer-group>	Enter the name of an existing peer-group. For information on how to create peer groups, refer to the neighbor peer-group (add a neighbor) command, and neighbor route-map command. When this parameter is used with this command, the command applies on all peers in the specified group.
<route-map-name>	The name of the route-map used to select routes to be unsuppressed.

Mode [BGP] Router Configuration or IPv4 Address Family Configuration

Mode [BGP4+] IPv6 Address Family Configuration

Usage When the [aggregate-address](#) command is used with the **summary-only** option, the more-specific routes of the aggregate are suppressed to all neighbors. Use this command instead to selectively leak more-specific routes to a particular neighbor.

Examples [BGP] To allow the device to advertise specific routes in the routemap 'mymap', which would have otherwise been aggregated to neighbor 10.10.0.73, use the commands:

```
awplus# configure terminal
awplus(config)# router bgp 10
awplus(config-router)# neighbor 10.10.0.73 unsuppress-map mymap
```

To stop the device from advertising specific routes in the routemap, use the commands:

```
awplus# configure terminal
awplus(config)# router bgp 10
awplus(config-router)# no neighbor 10.10.0.73 unsuppress-map
mymap
```

To allow the device to advertise specific IPv4 routes in the routemap 'mymap', which would have otherwise been aggregated to neighbor 10.10.0.73, use the commands:

```
awplus# configure terminal
awplus(config)# router bgp 10
awplus(config-router)# address-family ipv4 unicast
awplus(config-router-af)# neighbor 10.10.0.70 unsuppress-map
mymap
```

To stop the device from advertising specific IPv4 routes in the routemap, use the commands:

```
awplus# configure terminal
awplus(config)# router bgp 10
awplus(config-router)# address-family ipv4 unicast
awplus(config-router-af)# no neighbor 10.10.0.70 unsuppress-map
mymap
```

To allow the device to advertise specific routes in the routemap 'mymap', which would have otherwise been aggregated to peer group 'group1', use the commands:

```
awplus# configure terminal
awplus(config)# router bgp 10
awplus(config-router)# neighbor group1 peer-group
awplus(config-router)# neighbor 10.10.10.1 remote-as 10
awplus(config-router)# neighbor 10.10.10.1 peer-group group1
awplus(config-router)# neighbor group1 unsuppress-map mymap
```

To stop the device from advertising specific routes in the routemap to peer group 'group1', use the commands:

```
awplus# configure terminal
awplus(config)# router bgp 10
awplus(config-router)# no neighbor group1 unsuppress-map mymap
```

Examples [BGP4+] To allow the device to advertise specific IPv6 routes in the routemap 'mymap', which would have otherwise been aggregated to neighbor 2001:0db8:010d::1, use the commands:

```
awplus# configure terminal
awplus(config)# router bgp 10
awplus(config-router)# address-family ipv6 unicast
awplus(config-router-af)# neighbor 2001:0db8:010d::1
unsuppress-map mymap
```

To stop the device from advertising specific IPv6 routes in the routemap, use the commands:

```
awplus# configure terminal
awplus(config)# router bgp 10
awplus(config-router)# address-family ipv6 unicast
awplus(config-router-af)# no neighbor 2001:0db8:010d::1
unsuppress-map mymap
```

To allow the device to advertise specific IPv6 routes in the routemap 'mymap', which would have otherwise been aggregated to peer group 'group1', use the commands

```
awplus# configure terminal
awplus(config)# router bgp 10
awplus(config-router)# neighbor group1 peer-group
awplus(config-router)# neighbor 2001:0db8:010d::1 remote-as 10
awplus(config-router)# address-family ipv6
awplus(config-router-af)# neighbor 2001:0db8:010d::1
peer-group group1
awplus(config-router-af)# neighbor group1 unsuppress-map mymap
```

To stop the device from advertising specific IPv6 routes in the routemap to peer group 'group1', use the commands:

```
awplus# configure terminal
awplus(config)# router bgp 10
awplus(config-router)# address-family ipv6
awplus(config-router-af)# no neighbor group1 unsuppress-map
mymap
```

Related commands [aggregate-address](#)
[neighbor peer-group \(add a neighbor\)](#)
[neighbor route-map](#)

Command changes Added to AlliedWare Plus prior to 5.4.6-1
Version 5.4.7-2.1: BGP support added for IEx510, x550 series
Version 5.4.7-2.4: BGP support added for IE300 series

neighbor update-source

Overview Use this command to specify the source IPv4 or IPv6 address of BGP or BGP4+ packets, which are sent to the neighbor for routing updates, as the IPv4 or IPv6 address configured on the specified interface. The specified interface is usually the local loopback (lo) interface to allow internal BGP or BGP4+ connections to stay up regardless of which interface is used to reach a neighbor.

Use the **no** variant of this command to remove the IPv4 or IPv6 address from the interface as the source IPv4 or IPv6 address of BGP or BGP4+ packets sent to the neighbor, and restores the interface assignment to the closest interface, which is also called the best local address.

Syntax `neighbor <neighborid> update-source <interface>`
`no neighbor <neighborid> update-source`

Parameter	Description
<code><neighborid></code>	{ <code><ip-address></code> <code><ipv6-addr></code> <code><peer-group></code> }
<code><ip-address></code>	Specify the address of an IPv4 BGP neighbor, in dotted decimal notation A.B.C.D.
<code><ipv6-addr></code>	Specify the address of an IPv6 BGP4+ neighbor, entered in hexadecimal in the format X:X::X:X.
<code><peer-group></code>	Enter the name of an existing peer-group. For information on how to create peer groups, refer to the neighbor peer-group (add a neighbor) command, and neighbor route-map command. When this parameter is used with this command, the command applies on all peers in the specified group.
<code><interface></code>	Specifies the local loopback interface (lo).

Default Use of this command sets a default value of 2 for the maximum hop count.

Mode [BGP] Router Configuration or IPv4 Address Family Configuration

Mode [BGP4+] Router Configuration

Usage Use this command in conjunction with any specified interface on the router. The local loopback interface is the interface that is most commonly used with this command. The use of local loopback interface eliminates a dependency and BGP or BGP4+ does not have to rely on the availability of a particular interface for making BGP or BGP4+ peer relationships.

Examples [BGP] To source BGP connections for neighbor 10.10.0.72 with the IP address of the local loopback address instead of the best local address, enter the commands listed below:

```
awplus(config)# interface lo
awplus(config-if)# ip address 10.10.0.73/24
awplus(config-if)# exit
awplus(config)# router bgp 100
awplus(config-router)# network 10.10.0.0
awplus(config-router)# neighbor 10.10.0.72 remote-as 110
awplus(config-router)# neighbor 10.10.0.72 update-source lo
```

To remove BGP connections for neighbor 10.10.0.72 with the IP address of the local loopback address instead of the best local address, enter the commands listed below:

```
awplus(config)# router bgp 100
awplus(config-router)# no neighbor 10.10.0.72 update-source
```

To source BGP connections for neighbor group1 with the IP address of the local loopback address instead of the best local address, enter the commands listed below:

```
awplus(config)# interface lo
awplus(config-if)# ip address 10.10.0.73/24
awplus(config-if)# exit
awplus(config)# router bgp 100
awplus(config-router)# network 10.10.0.0
awplus(config-router)# neighbor group1 peer-group
awplus(config-router)# neighbor 10.10.0.72 remote-as 100
awplus(config-router)# neighbor 10.10.0.72 peer-group group1
awplus(config-router)# neighbor group1 update-source lo
```

To remove BGP connections for neighbor group1 with the IP address of the local loopback address instead of the best local address, enter the commands listed below:

```
awplus(config)# router bgp 100
awplus(config-router)# neighbor group1 update-source lo
```

Examples [BGP4+] To source BGP connections for neighbor 2001:0db8:010d::1 with the IPv6 address of the local loopback address instead of the best local address, enter the commands listed below:

```
awplus(config)# interface lo
awplus(config-if)# ipv6 address 2001:0db8:010d::1/128
awplus(config-if)# exit
awplus(config)# router bgp 100
awplus(config-router)# neighbor 2001:0db8:010d::1 remote-as 110
awplus(config-router)# neighbor 2001:0db8:010d::1
update-source lo
```

To remove BGP connections for neighbor 2001:0db8:010d::1 with the IPv6 address of the local loopback address instead of the best local address, enter the commands listed below:

```
awplus(config)# router bgp 100
awplus(config-router)# no neighbor 2001:0db8:010d::1
update-source
```

To source BGP connections for neighbor group1 with the IPv6 address of the local loopback address instead of the best local address, enter the commands listed below:

```
awplus(config)# interface lo
awplus(config-if)# ipv6 address 2001:0db8:010d::1/128
awplus(config-if)# exit
awplus(config)# router bgp 100
awplus(config-router)# neighbor group1 peer-group
awplus(config-router)# neighbor 2001:0db8:010d::1 remote-as 100
awplus(config-router)# address-family ipv6
awplus(config-router-af)# neighbor 2001:0db8:010d::1 peer-group group1
awplus(config-router-af)# exit
awplus(config-router)# neighbor group1 update-source lo
```

To remove BGP connections for neighbor group1 with the IPv6 address of the local loopback address instead of the best local address, enter the commands listed below:

```
awplus(config)# router bgp 100
awplus(config-router)# neighbor group1 update-source lo
```

Related commands [neighbor peer-group \(add a neighbor\)](#)
[neighbor route-map](#)

Command changes Added to AlliedWare Plus prior to 5.4.6-1
Version 5.4.7-2.1: BGP support added for IEx510, x550 series

Version 5.4.7-2.4: BGP support added for IE300 series

neighbor version (BGP only)

Overview Use this command to configure the device to accept only a particular BGP version. Use the **no** variant of this command to use the default BGP version (version 4).

Syntax `neighbor <neighborid> version <version>`
`no neighbor <neighborid> version`

Parameter	Description
<neighborid>	{ <ip-address> <peer-group> }
	<ip-address> The address of an IPv4 BGP neighbor, in dotted decimal notation A.B.C.D.
	<peer-group> Enter the name of an existing peer-group. For information on how to create peer groups, refer to the neighbor peer-group (add a neighbor) command, and neighbor route-map command. When this parameter is used with this command, the command applies on all peers in the specified group.
<version>	{4} Specifies the BGP version number.

Mode Router Configuration or IPv4 Address Family Configuration

Usage notes By default, the system uses BGP version 4 and on request dynamically negotiates down to version 2. Using this command disables the router's version-negotiation capability and forces the router to use only a specified version with the neighbor.

Examples

```
awplus# configure terminal
awplus(config)# router bgp 10
awplus(config-router)# neighbor 10.10.10.1 version 4
awplus# configure terminal
awplus(config)# router bgp 10
awplus(config-router)# neighbor group1 peer-group
awplus(config-router)# neighbor 10.10.10.1 remote-as 10
awplus(config-router)# neighbor 10.10.10.1 peer-group group1
awplus(config-router)# neighbor group1 version 4
awplus# configure terminal
awplus(config)# router bgp 10
awplus(config-router)# no neighbor 10.10.10.1 version
awplus# configure terminal
awplus(config)# router bgp 10
awplus(config-router)# no neighbor group1 version
```

Related commands [neighbor peer-group \(add a neighbor\)](#)
[neighbor route-map](#)

Command changes Added to AlliedWare Plus prior to 5.4.6-1
Version 5.4.7-2.1: BGP support added for IEx510, x550 series
Version 5.4.7-2.4: BGP support added for IE300 series

neighbor weight

Overview Use this command to set default weights for routes from this BGP or BGP4+ neighbor.

Use the **no** variant of this command to remove a weight assignment.

Syntax `neighbor <neighborid> weight <weight>`
`no neighbor <neighborid> weight [<weight>]`

Parameter	Description
<code><neighborid></code>	<code>{<ip-address> <ipv6-addr> <peer-group>}</code>
<code><ip-address></code>	Specify the address of an IPv4 BGP neighbor, in dotted decimal notation A.B.C.D.
<code><ipv6-addr></code>	Specify the address of an IPv6 BGP4+ neighbor, entered in hexadecimal in the format X:X::X:X.
<code><peer-group></code>	Enter the name of an existing peer-group. For information on how to create peer groups, refer to the neighbor peer-group (add a neighbor) command, and neighbor route-map command. When this parameter is used with this command, the command applies on all peers in the specified group.
<code><weight></code>	<code><0-65535></code> Specifies the weight this command assigns to the route.

Mode [BGP] Router Configuration or IPv4 Address Family Configuration

Mode [BGP4+] IPv6 Address Family Configuration

Usage notes Use this command to specify a weight value to all routes learned from a BGP or BGP4+ neighbor. The route with the highest weight gets preference when there are other routes on the network.

Unlike the local-preference attribute, the weight attribute is relevant only to the local router.

The weights assigned using the **set weight** command overrides the weights assigned using this command.

Examples [BGP]

```
awplus# configure terminal
awplus(config)# router bgp 10
awplus(config-router)# neighbor 10.10.10.1 weight 60
awplus# configure terminal
awplus(config)# router bgp 10
awplus(config-router)# no neighbor 10.10.10.1 weight
awplus# configure terminal
awplus(config)# router bgp 10
awplus(config-router)# address-family ipv4
awplus(config-router-af)# neighbor 10.10.10.1 weight 60
awplus# configure terminal
awplus(config)# router bgp 10
awplus(config-router)# address-family ipv4
awplus(config-router-af)# no neighbor 10.10.10.1 weight
awplus# configure terminal
awplus(config)# router bgp 10
awplus(config-router)# neighbor group1 peer-group
awplus(config-router)# neighbor 10.10.10.1 remote-as 10
awplus(config-router)# neighbor 10.10.10.1 peer-group group1
awplus(config-router)# neighbor group1 weight 60
awplus# configure terminal
awplus(config)# router bgp 10
awplus(config-router)# no neighbor group1 weight
```

Examples
[BGP4+]

```
awplus# configure terminal
awplus(config)# router bgp 10
awplus(config-router)# address-family ipv6
awplus(config-router-af)# neighbor 2001:0db8:010d::1 weight 60
awplus# configure terminal
awplus(config)# router bgp 10
awplus(config-router)# address-family ipv6
awplus(config-router-af)# no neighbor 2001:0db8:010d::1 weight
awplus# configure terminal
awplus(config)# router bgp 10
awplus(config-router)# neighbor group1 peer-group
awplus(config-router)# neighbor 2001:0db8:010d::1 remote-as 10
awplus(config-router)# address-family ipv6
awplus(config-router-af)# neighbor 2001:0db8:010d::1
peer-group group1
awplus(config-router-af)# neighbor group1 weight 60
awplus# configure terminal
awplus(config)# router bgp 10
awplus(config-router)# address-family ipv6
awplus(config-router-af)# no neighbor group1 weight
```

Related commands [neighbor peer-group \(add a neighbor\)](#)
[neighbor route-map](#)

Command changes Added to AlliedWare Plus prior to 5.4.6-1
Version 5.4.7-2.1: BGP support added for IEx510, x550 series
Version 5.4.7-2.4: BGP support added for IE300 series

network (BGP and BGP4+)

Overview Use this command to specify particular routes to be advertised into the BGP or BGP4+ routing process. A unicast network address without a mask is accepted if it falls into the natural boundary of its class. A class-boundary mask is derived if the address matches its natural class-boundary.

Note that you can specify a prefix length for the prefix being added, and you can also specify a classful network without a prefix length and an appropriate prefix length is added. Note that specifying a non-classful prefix without a prefix length results in a /32 prefix length on an IPv4 route.

Use the **no** variant of this command to remove a network route entry.

Syntax [BGP] `network {<ip-prefix/length>|<ip-network-addr>} [mask <network-mask>] [route-map <route-map-name>] [backdoor]`
`no network {<ip-prefix/length>|<ip-network-addr>} [mask <network-mask>] [route-map <route-map-name>] [backdoor]`

Syntax [BGP4+] `network {<ipv6-prefix/length>|<ipv6-network-addr>} [route-map <route-map-name>]`
`no network {<ipv6-prefix/length>|<ipv6-network-addr>} [route-map <route-map-name>]`

Parameter	Description
<code><ip-prefix/length></code>	IP network prefix and prefix length entered in dotted decimal format for the IP network prefix, then slash notation for the prefix length in the format A.B.C.D/M, e.g. 192.168.1.224/27
<code><ip-network-addr></code>	IP network prefix entered in dotted decimal format A.B.C.D, e.g. 192.168.1.224
<code><network-mask></code>	Specify a network mask in the format A.B.C.D, e.g. 255.255.255.224.
<code><ipv6-prefix/length></code>	IPv6 network prefix and prefix length entered in dotted decimal format for the IPv6 network prefix, then slash notation for the IPv6 prefix length in the format X:X::X/X/M, e.g. 2001:db8::/64
<code><ipv6-network-addr></code>	IP network prefix entered in dotted decimal format A.B.C.D, e.g. 192.168.1.224
<code><route-map-name></code>	Specify the name of the route map.
<code>backdoor</code>	Specify a BGP backdoor route that is not advertised.

Mode [BGP] Router Configuration and IPv4 Address Family [ipv4 unicast] mode

Mode [BGP4+] IPv6 Address Family Configuration

Usage notes It does not matter how the route is arranged in the IP or IPv6 routing table. The route can arrive in the IP routing table by a static route, or the route can be learned from OSPF or OSPFv3 or RIP or RIPng routing.

If you configure a route-map, then that route-map will be used in filtering the network, or the route-map will be used to modify the attributes that are advertised with the route.

Example [BGP] The following example illustrates a Class-A address configured as a network route. The natural Class-A network prefix mask length of 8 will be internally derived, that is, 2.0.0.0/8.

```
awplus(config)# router bgp 100
awplus(config-router)# network 2.0.0.0
```

Output [BGP] Figure 29-1: Example output from the **show running-config** command after entering **network 2.0.0.0**

```
awplus#show running-config
router bgp 100
network 2.0.0.0/8
```

Example [BGP] The following example illustrates a network address which does not fall into its natural class boundary, and hence, is perceived as a host route, that is, 192.0.2.224/27.

```
awplus(config)# router bgp 100
awplus(config-router)# network 192.0.2.224 mask 255.255.255.224
```

Output [BGP] Figure 29-2: Example output from the **show running-config** command after entering **network 192.0.2.224 mask 255.255.255.224**

```
awplus#show running-config
router bgp 100
network 192.0.2.224/27
```

Example [BGP] The following example is the same as the previous example for host route 192.0.2.224/27, but is entered in prefix/length format using slash notation (instead of prefix plus mask in dotted decimal format using the **mask** keyword before the network mask in dotted decimal format):

```
awplus(config)# router bgp 100
awplus(config-router)# network 192.0.2.224/27
```

Example [BGP4+] The following example is the same as the previous example for host route 2001:db8::/32:

```
awplus(config)# router bgp 100
awplus(config-router)# address-family ipv6
awplus(config-router-af)# network 2001:db8::/32
```

Output [BGP4+] Figure 29-3: Example output from the **show running-config** command after entering **network 2001:db8::/32**

```
awplus#show running-config

router bgp 100
 network 2001:db8::/32
```

**Command
changes**

Added to AlliedWare Plus prior to 5.4.6-1

Version 5.4.7-2.1: BGP support added for IEx510, x550 series

Version 5.4.7-2.4: BGP support added for IE300 series

network synchronization

Overview Use this command to ensure the exact same static network prefix, specified through any of the **network** commands, is local or has IGP reachability before introduction to BGP or BGP4+.

Use the **no** variant of this command to disable this function.

Syntax `network synchronization`
`no network synchronization`

Default Network synchronization is disabled by default.

Mode [BGP] Router Configuration and IPv4 Address Family [ipv4 unicast] Configuration

Mode [BGP4+] IPv6 Address Family [ipv6 unicast] Configuration

Examples [BGP] The following example enables IGP synchronization of BGP static network routes in the Router Configuration mode.

```
awplus# configure terminal
awplus(config)# router bgp 11
awplus(config-router)# network synchronization
```

The following example enables IGP synchronization of BGP static network routes in the IPv4-Unicast address family.

```
awplus# configure terminal
awplus(config)# router bgp 11
awplus(config-router)# address-family ipv4 unicast
awplus(config-router-af)# network synchronization
```

Example [BGP4+] The following example enables IGP synchronization of BGP4+ static network routes in the IPv6-Unicast address family.

```
awplus# configure terminal
awplus(config)# router bgp 11
awplus(config-router)# address-family ipv6 unicast
awplus(config-router-af)# network synchronization
```

Command changes Added to AlliedWare Plus prior to 5.4.6-1
Version 5.4.7-2.1: BGP support added for IEx510, x550 series
Version 5.4.7-2.4: BGP support added for IE300 series

redistribute (into BGP or BGP4+)

Overview Use this command to inject routes from one routing process into a BGP or BGP4+ routing table.

Use the **no** variant of this command to disable this function.

Syntax redistribute {ospf|rip|connected|static} [route-map
<route-map-entry-pointer>]

no redistribute {ospf|rip|connected|static} [route-map
<route-map-entry-pointer>]

Parameter	Description
connected	Specifies the redistribution of connected routes for both BGP and BGP4+.
ospf	Specifies the redistribution of OSPF information for BGP or OSPFv3 information for BGP4+.
rip	Specifies the redistribution of RIP information for BGP or RIPng information for BGP4+.
static	Specifies the redistribution of Static routes for both BGP and BGP4+.
route-map	Route map reference for both BGP and BGP4+.
<route-map-entry-pointer>	Pointer to route-map entries.

Mode [BGP] Router Configuration or IPv4 Address Family Configuration

Mode [BGP4+] Router Configuration or IPv6 Address Family Configuration

Usage notes Redistribution is used by routing protocols to advertise routes that are learned by some other means, such as by another routing protocol or by static routes. Since all internal routes are dumped into BGP, careful filtering is applied to make sure that only routes to be advertised reach the internet, not everything. This command allows redistribution by injecting prefixes from one routing protocol into another routing protocol.

Examples [BGP/ BGP+] The following example shows the configuration of a route-map named `rmap1`, which is then applied using the **redistribute route-map** command.

```
awplus# configure terminal
awplus(config)# route-map rmap1 permit 1
awplus(config-route-map)# match origin incomplete
awplus(config-route-map)# set metric 100
awplus(config-route-map)# exit
awplus(config)# router bgp 12
awplus(config-router)# redistribute ospf route-map rmap1
```

To apply the above example to a specific VRF instance named `blue`, use the following commands:

```
awplus(config)# router bgp 12
awplus(config-router)# address-family ipv4 vrf blue
awplus(config-router-af)# redistribute ospf route-map rmap1
```

The following example shows the configuration of a route-map named `rmap2`, which is then applied using the **redistribute route-map** command.

```
awplus# configure terminal
awplus(config)# route-map rmap2 permit 3
awplus(config-route-map)# match interface eth1
awplus(config-route-map)# set metric-type 1
awplus(config-route-map)# exit
awplus(config)# router ospf 100
awplus(config-router)# redistribute bgp route-map rmap2
```

Note that configuring a route-map and applying it with the **redistribute route-map** command allows you to filter which routes are distributed from another routing protocol (such as OSPF with BGP). A route-map can also set the metric, tag, and metric-type of the redistributed routes.

**Command
changes**

Added to AlliedWare Plus prior to 5.4.6-1

Version 5.4.6-2.1: VRF-lite support added to BGP for AR-series products

Version 5.4.7-2.1: BGP support added for IEx510, x550 series

Version 5.4.7-2.4: BGP support added for IE300 series

restart bgp graceful (BGP only)

Overview Use this command to force the device to perform a graceful BGP restart.

Syntax `restart bgp graceful`

Mode Privileged Exec

Usage Before using this command, BGP graceful-restart capabilities must be enabled within the router BGP ([bgp graceful-restart](#) command), and each neighbor configured on the device should be set to advertise its graceful-restart capability ([bgp graceful-restart graceful-reset](#) command). The neighbor devices also need to have BGP graceful-restart capabilities enabled ([bgp graceful-restart](#) command).

This command stops the whole BGP process and makes the device retain the BGP routes and mark them as stale. Receiving BGP speakers, retain and mark as stale all BGP routes received from the restarting speaker for all the address families received in the Graceful Restart Capability exchange.

When a **restart bgp graceful** command is issued, the BGP configuration is reloaded from the last saved configuration. Ensure you first issue a **copy running-config startup-config**.

Example `awplus# restart bgp graceful`

Related commands [bgp graceful-restart](#)
[bgp graceful-restart graceful-reset](#)

Command changes Added to AlliedWare Plus prior to 5.4.6-1
Version 5.4.7-2.1: BGP support added for IEx510, x550 series
Version 5.4.7-2.4: BGP support added for IE300 series

router bgp

Overview Use this command to configure a BGP routing process, specifying the 32-bit Autonomous System (AS) number.

Use the **no** variant of this command to disable a BGP routing process, specifying the 32-bit AS number.

Syntax router bgp <asn>
no router bgp <asn>

Parameter	Description
<asn>	<1-4294967295> Specifies the 32-bit Autonomous System (AS) number.

Mode Global Configuration

Usage The **router bgp** command enables a BGP routing process:

```
router bgp 1
  neighbor 10.0.0.1 remote-as 1
  neighbor 10.0.0.2 remote-as 1
  !
router bgp 2
  neighbor 10.0.0.3 remote-as 2
  neighbor 10.0.0.4 remote-as 2
```

Examples awplus# configure terminal
awplus(config)# router bgp 12
awplus(config-router)#
awplus# configure terminal
awplus(config)# no router bgp 12
awplus(config)#

Command changes Added to AlliedWare Plus prior to 5.4.6-1
Version 5.4.7-2.1: BGP support added for IEx510, x550 series
Version 5.4.7-2.4: BGP support added for IE300 series

route-map

Overview Use this command to configure a route map entry, and to specify whether the device will process or discard matching routes and BGP update messages.

The device uses a name to identify the route map, and a sequence number to identify each entry in the route map.

The **route-map** command puts you into route-map configuration mode. In this mode, you can use the following:

- one or more of the **match** commands to create match clauses. These specify what routes or update messages match the entry.
- one or more of the **set** commands to create set clauses. These change the attributes of matching routes or update messages.

Use the **no** variant of this command to delete a route map or to delete an entry from a route map.

Syntax `route-map <mapname> {deny|permit} <seq>`
`no route-map <mapname>`
`no route-map <mapname> {deny|permit} <seq>`

Parameter	Description
<mapname>	A name to identify the route map.
deny	The route map causes a routing process to discard matching routes or BGP update messages.
permit	The route map causes a routing process to use matching routes or BGP update messages.
<seq>	<1-65535> The sequence number of the entry. You can use this parameter to control the order of entries in this route map.

Mode Global Configuration

Usage notes Route maps allow you to control and modify routing information by filtering routes and setting route attributes. You can apply route maps when the device:

- processes BGP update messages that it has received from a peer
- prepares BGP update messages to send to peers
- redistributes routes from one routing protocol into another
- redistributes static routes into routing protocols
- uses BGP route flap dampening

When a routing protocol passes a route or update message through a route map, it checks the entries in order of their sequence numbers, starting with the lowest numbered entry.

If it finds a match on a route map with an action of permit, then it applies any set clauses and accepts the route. Having found a match, the route is not compared against any further entries of the route map.

If it finds a match on a route map with an action of deny, it will discard the matching route.

If it does not find a match, it discards the route or update message. This means that route maps end with an implicit deny entry. To permit all non-matching routes or update messages, end your route map with an entry that has an action of **permit** and no match clause.

Examples To enter route-map mode for entry 1 of the route map called "route1", and then add a match and set clause to it, use the commands:

```
awplus# configure terminal
awplus(config)# route-map route1 permit 1
awplus(config-route-map)# match as-path 60
awplus(config-route-map)# set weight 70
```

To enter route-map mode for entry 2 of the route map called "route1", and then add a match and set clause to it, use the commands:

```
awplus# configure terminal
awplus(config)# route-map route1 permit 2
awplus(config-route-map)# match interface eth1
awplus(config-route-map)# set metric 20
```

Note how the prompt changes when you go into route map configuration mode.

To make the device process non-matching routes instead of discarding them, add a command like the following one:

```
awplus(config)# route-map route1 permit 100
```

Related commands

For BGP:

- show route-map
- bgp dampening
- neighbor default-originate
- neighbor route-map
- neighbor unsuppress-map
- network (BGP and BGP4+)
- redistribute (into BGP or BGP4+)
- show ip bgp route-map (BGP only)

For OSPF:

- default-information originate
- redistribute (OSPF)

For RIP:

`redistribute (RIP)`

set as-path

Overview Use this command to add an AS path set clause to a route map entry.

When a BGP update message matches the route map entry, the device prepends the specified Autonomous System Number (ASN) or ASNs to the update's AS path attribute.

The AS path attribute is a list of the autonomous systems through which the announcement for the prefix has passed. As prefixes pass between autonomous systems, each autonomous system adds its ASN to the beginning of the list. This means that the AS path attribute can be used to make routing decisions.

Use the **no** variant of this command to remove the set clause.

Syntax `set as-path prepend <1-65535> [<1-65535>]...`
`no set as-path prepend [<1-65535> [<1-65535>]...]`

Parameter	Description
<code>prepend</code>	Prepends the autonomous system path.
<code><1-65535></code>	The number to prepend to the AS path. If you specify multiple ASNs, separate them with spaces.

Mode Route-map mode

Usage notes Use the **set as-path** command to specify an autonomous system path. By specifying the length of the AS-Path, the device influences the best path selection by a neighbor. Use the `prepend` parameter with this command to prepend an AS path string to routes increasing the AS path length.

This command is valid for BGP update messages only.

Example To use entry 3 of the route map called `myroute` to prepend ASN 8 and 24 to the AS path of matching update messages, use the commands:

```
awplus# configure terminal
awplus(config)# route-map myroute permit 3
awplus(config-route-map)# set as-path prepend 8 24
```

Related commands [match as-path](#)
[route-map](#)
[show route-map](#)

Command changes Added to AlliedWare Plus prior to 5.4.6-1
Version 5.4.7-2.1: BGP support added for IEx510, x550 series
Version 5.4.7-2.4: BGP support added for IE300 series

set community

Overview Use this command to add a community set clause to a route map entry.

When a BGP update message matches the route map entry, the device takes one of the following actions:

- changes the update's community attribute to the specified value or values, or
- adds the specified community value or values to the update's community attribute, if you specify the **additive** parameter after specifying another parameter. or
- removes the community attribute from the update, if you specify the **none** parameter

Use the **no** variant of this command to remove the set clause.

Syntax

```
set community {[<1-65535>][AA:NN] [internet] [local-AS]
[no-advertise] [no-export] [additive]}
no set community {[AA:NN] [internet] [local-AS] [no-advertise]
[no-export] [additive]}
set community none
no set community none
```

Parameter	Description
<1-65535>	The AS number of the community as an integer not in AA:NN format.
AA:NN	The Autonomous System (AS) number of the community, in AA:NN format. AS numbers are assigned to the regional registries by the IANA (www.iana.org) and can be obtained from the registry in your region. AA and NN are both integers from 1 to 65535. AA is the AS number; NN is a value chosen by the ASN administrator.
local-AS	The community of routes that must not be advertised to external BGP peers (this includes peers in other members' Autonomous Systems inside a BGP confederation).
internet	The community of routes that can be advertised to all BGP peers.
no-advertise	The community of routes that must not be advertised to other BGP peers.
no-export	The community of routes that must not be advertised outside a BGP confederation boundary (a standalone Autonomous System that is not part of a confederation should be considered a confederation itself).

Parameter	Description
none	The device removes the community attribute from matching update messages.
additive	The device adds the specified community value to the update message's community attribute, instead of replacing the existing attribute. By default this parameter is not included, so the device replaces the existing attribute.

Mode Route-map Configuration

Usage notes This command is valid for BGP update messages only.

Examples To use entry 3 of the route map called `rmap1` to put matching routes into the no-advertise community, use the commands:

```
awplus# configure terminal
awplus(config)# route-map rmap1 permit 3
awplus(config-route-map)# set community no-advertise
```

To use entry 3 of the route map called `rmap1` to put matching routes into several communities, use the commands:

```
awplus# configure terminal
awplus(config)# route-map rmap1 permit 3
awplus(config-route-map)# set community 10:01 23:34 12:14
no-export
```

To use entry 3 of the route map called `rmap1` to put matching routes into a single AS community numbered 16384, use the commands:

```
awplus# configure terminal
awplus(config)# route-map rmap1 permit 3
awplus(config-route-map)# set community 16384 no-export
```

Related commands [match community](#)
[route-map](#)

[set aggregator](#)
[set comm-list delete](#)
[set extcommunity](#)
[show route-map](#)

Command changes Added to AlliedWare Plus prior to 5.4.6-1
Version 5.4.7-2.1: BGP support added for IEx510, x550 series
Version 5.4.7-2.4: BGP support added for IE300 series

show bgp ipv6 (BGP4+ only)

Overview Use this command to display BGP4+ network information for a specified IPv6 address.

For information on filtering and saving command output, see the [“Getting Started with AlliedWare Plus” Feature Overview and Configuration Guide](#).

Syntax `show bgp ipv6 <ipv6-addr>`

Parameter	Description
<code><ipv6-addr></code>	Specifies the IPv6 address, entered in hexadecimal in the format X:X::X:X.

Mode User Exec and Privileged Exec

Example `awplus# show bgp ipv6 2001:0db8:010d::1`

Related commands [show bgp ipv6 longer-prefixes \(BGP4+ only\)](#)

Command changes
Added to AlliedWare Plus prior to 5.4.6-1
Version 5.4.7-2.1: BGP support added for IEx510, x550 series
Version 5.4.7-2.4: BGP support added for IE300 series

show bgp ipv6 community (BGP4+ only)

Overview Use this command to display routes that match specified communities within an IPv6 environment. Use the [show ip bgp community \(BGP only\)](#) command within an IPv4 environment.

For information on filtering and saving command output, see the [“Getting Started with AlliedWare Plus” Feature Overview and Configuration Guide](#).

You may use any combination and repetition of parameters listed in the *<type>* placeholder.

Syntax `show bgp ipv6 community [<type>] [exact-match]`

Parameter	Description
<i><type></i>	{[AA:NN] [local-AS] [no-advertise] [no-export]}
AA:NN	Specifies the Autonomous System (AS) community number, in AA:NN format.
local-AS	Do not send outside local Autonomous Systems (well-known community).
no-advertise	Do not advertise to any peer (well-known community).
no-export	Do not export to next AS (well-known community).
exact-match	Specifies that the exact match of the communities is displayed. This optional parameter cannot be repeated.

Mode User Exec and Privileged Exec

Examples Note that the AS numbers shown are examples only.

```
awplus# show bgp ipv6 community 64497:64499 exact-match
awplus# show bgp ipv6 community 64497:64499 64500:64501
exact-match
awplus# show bgp ipv6 community 64497:64499 64500:64501
64510:64511no-advertise
awplus# show bgp ipv6 community no-advertise
no-advertiseno-advertise exact-match
awplus# show bgp ipv6 community no-export 64510:64511
no-advertise local-AS no-export
awplus# show bgp ipv6 community no-export 64510:64511
no-advertise 64497:64499 64500:64501 no-export
awplus# show bgp ipv6 community no-export 64497:64499
no-advertise local-AS no-export
```

Related commands [show ip bgp community \(BGP only\)](#)

Command changes
Added to AlliedWare Plus prior to 5.4.6-1
Version 5.4.7-2.1: BGP support added for IEx510, x550 series
Version 5.4.7-2.4: BGP support added for IE300 series

show bgp ipv6 community-list (BGP4+ only)

Overview Use this command to display routes that match the given community-list within an IPv6 environment. Use the [show ip bgp community-list \(BGP only\)](#) command within an IPv4 environment.

For information on filtering and saving command output, see the [“Getting Started with AlliedWare Plus” Feature Overview and Configuration Guide](#).

Syntax `show bgp ipv6 community-list <listname> [exact-match]`

Parameter	Description
<listname>	Specifies the community list name.
exact-match	Displays only routes that have exactly the same specified communities.

Mode User Exec and Privileged Exec

Example `awplus# show bgp ipv6 community-list mylist exact-match`

Related commands [show ip bgp community-list \(BGP only\)](#)

Command changes Added to AlliedWare Plus prior to 5.4.6-1
Version 5.4.7-2.1: BGP support added for IEx510, x550 series
Version 5.4.7-2.4: BGP support added for IE300 series

show bgp ipv6 dampening (BGP4+ only)

Overview Use this command to show dampened routes from a BGP4+ instance within an IPv6 environment. Use the [show ip bgp dampening \(BGP only\)](#) command to show dampened routes from a BGP instance within an IPv4 environment.

For information on filtering and saving command output, see the [“Getting Started with AlliedWare Plus” Feature Overview and Configuration Guide](#).

Syntax `show bgp ipv6 dampening
{dampened-paths|flap-statistics|parameters}`

Parameter	Description
dampened-paths	Display paths suppressed due to dampening.
flap-statistics	Display flap statistics of routes.
parameters	Display details of configured dampening parameters.

Mode User Exec and Privileged Exec

Usage notes Enable BGP4+ dampening to maintain dampened-path information in memory.

Examples

```
awplus# show bgp ipv6 dampening dampened-path  
awplus# show bgp ipv6 dampening flap-statistics  
awplus# show bgp ipv6 dampening parameter
```

Related commands [show ip bgp dampening \(BGP only\)](#)

Command changes

- Added to AlliedWare Plus prior to 5.4.6-1
- Version 5.4.7-2.1: BGP support added for IEx510, x550 series
- Version 5.4.7-2.4: BGP support added for IE300 series

show bgp ipv6 filter-list (BGP4+ only)

Overview Use this command to display routes conforming to the filter-list within an IPv6 environment. Use the [show ip bgp filter-list \(BGP only\)](#) command to display routes conforming to the filter-list within an IPv4 environment.

For information on filtering and saving command output, see the [“Getting Started with AlliedWare Plus” Feature Overview and Configuration Guide](#).

Syntax `show bgp ipv6 filter-list <listname>`

Parameter	Description
<listname>	Specifies the regular-expression access list name.

Mode User Exec and Privileged Exec

Example `awplus# show bgp ipv6 filter-list mylist`

Related commands [show ip bgp filter-list \(BGP only\)](#)

Command changes
Added to AlliedWare Plus prior to 5.4.6-1
Version 5.4.7-2.1: BGP support added for IEx510, x550 series
Version 5.4.7-2.4: BGP support added for IE300 series

show bgp ipv6 inconsistent-as (BGP4+ only)

Overview Use this command to display routes with inconsistent AS Paths within an IPv6 environment. Use the [show ip bgp inconsistent-as \(BGP only\)](#) command to display routes with inconsistent AS paths within an IPv4 environment.

For information on filtering and saving command output, see the [“Getting Started with AlliedWare Plus” Feature Overview and Configuration Guide](#).

Syntax `show bgp ipv6 inconsistent-as`

Mode User Exec and Privileged Exec

Example `awplus# show bgp ipv6 inconsistent-as`

Related commands [show ip bgp inconsistent-as \(BGP only\)](#)

Command changes

- Added to AlliedWare Plus prior to 5.4.6-1
- Version 5.4.7-2.1: BGP support added for IEx510, x550 series
- Version 5.4.7-2.4: BGP support added for IE300 series

show bgp ipv6 longer-prefixes (BGP4+ only)

Overview Use this command to display the route of the local BGP4+ routing table for a specific prefix with a specific mask or for any prefix having a longer mask than the one specified.

For information on filtering and saving command output, see the [“Getting Started with AlliedWare Plus” Feature Overview and Configuration Guide](#).

Syntax `show bgp ipv6 <ipv6-addr/prefix-length> longer-prefixes`

Parameter	Description
<code><ipv6-addr/prefix-length></code>	Specifies the IPv6 address with prefix length. The IPv6 address uses the format X:X::X/X/Prefix-Length. The prefix-length is usually set between 0 and 64.

Mode User Exec and Privileged Exec

Example `awplus# show bgp ipv6 2001:0db8::/64 longer-prefixes`

Related commands [show bgp ipv6 \(BGP4+ only\)](#)

Command changes
Added to AlliedWare Plus prior to 5.4.6-1
Version 5.4.7-2.1: BGP support added for IEx510, x550 series
Version 5.4.7-2.4: BGP support added for IE300 series

show bgp ipv6 neighbors (BGP4+ only)

Overview Use this command to display detailed information on peering connections to all BGP4+ neighbors within an IPv6 environment.

Use the [show ip bgp neighbors \(BGP only\)](#) command to display detailed information on peering connections to all BGP neighbors within an IPv4 environment.

For information on filtering and saving command output, see the [“Getting Started with AlliedWare Plus” Feature Overview and Configuration Guide](#).

Syntax `show bgp ipv6 neighbors [<ipv6-addr> [advertised-routes | received prefix-filter | received-routes | routes]]`

Parameter	Description
<ipv6-addr>	Specifies the IPv6 address, entered in hexadecimal in the format X:X::X:X.
advertised-routes	Displays the routes advertised to a BGP4+ neighbor.
received prefix-filter	Displays received prefix-list filters.
received-routes	Displays the received routes from the neighbor. To display all the received routes from the neighbor, configure the BGP4+ soft reconfigure first.
routes	Displays all accepted routes learned from neighbors.

Mode User Exec and Privileged Exec

Examples [BGP4+]

```
awplus# show bgp ipv6 neighbors 2001:0db8:010d::1 advertised-routes
awplus# show bgp ipv6 neighbors 2001:0db8:010d::1 received prefix-filter
awplus# show bgp ipv6 neighbors 2001:0db8:010d::1 received-routes
awplus# show bgp ipv6 neighbors 2001:0db8:010d::1 routes
```

Output Figure 29-4: Example output from **show bgp ipv6 neighbors 2001:db8:b::1**

```
awplus#show bgp ipv6 neighbors 2001:db8:b::1
BGP neighbor is 2001:db8:b::1, remote AS 200, local AS 100, external link
  BGP version 4, remote router ID 2.2.2.1
  BGP state = Established, up for 01:03:26
  Last read 01:03:26, hold time is 90, keepalive interval is 30 seconds
  Neighbor capabilities:
    Route refresh: advertised and received (old and new)
    4-Octet ASN Capability: advertised and received
    Address family IPv4 Unicast: advertised and received
    Address family IPv6 Unicast: advertised and received
  Received 157 messages, 0 notifications, 0 in queue
  Sent 228 messages, 0 notifications, 0 in queue
  Route refresh request: received 0, sent 0
  Minimum time between advertisement runs is 30 seconds
  Update source is lo
For address family: IPv4 Unicast
  BGP table version 1, neighbor version 1
  Index 2, Offset 0, Mask 0x4
  Community attribute sent to this neighbor (both)
  0 accepted prefixes
  0 announced prefixes

For address family: IPv6 Unicast
  BGP table version 66, neighbor version 66
  Index 2, Offset 0, Mask 0x4
  AF-dependant capabilities:
    Graceful restart: advertised, received

  Community attribute sent to this neighbor (both)
  Default information originate, default sent
  Inbound path policy configured
  Incoming update prefix filter list is *BGP_FILTER_LIST
  Route map for incoming advertisements is *BGP_LOCAL_PREF_MAP
  8 accepted prefixes
  8 announced prefixes

Connections established 1; dropped 0
Graceful-restart Status:
  Remote restart-time is 90 sec

  External BGP neighbor may be up to 2 hops away.
Local host: 2001:db8:a::1, Local port: 179
Foreign host: 2001:db8:b::1, Foreign port: 50672
Nexthop: 1.1.1.1
Nexthop global: 2001:db8:a::1
Nexthop local: ::
BGP connection: non shared network
```

If available the following is shown:

- Session information
 - Neighbor address, ASN information and if the link is external or internal
 - BGP version and status
 - Neighbor capabilities for the BGP session
 - Number of messages transmitted and received
- IPv6 unicast address family information
 - BGP4+ table version
 - IPv6 Address Family dependent capabilities
 - IPv6 Communities
 - IPv6 Route filters for ingress and egress updates
 - Number of announced and accepted IPv6 prefixes
- Connection information
 - Connection counters
 - Graceful restart timer
 - Hop count to the peer
 - Next hop information
 - Local and external port numbers

Related commands [show ip bgp neighbors \(BGP only\)](#)

Command changes Added to AlliedWare Plus prior to 5.4.6-1
Version 5.4.7-2.1: BGP support added for IEx510, x550 series
Version 5.4.7-2.4: BGP support added for IE300 series

show bgp ipv6 paths (BGP4+ only)

Overview Use this command to display BGP4+ path information within an IPv6 environment. Use the [show ip bgp paths \(BGP only\)](#) command to display BGP path information within an IPv4 environment.

For information on filtering and saving command output, see the [“Getting Started with AlliedWare Plus” Feature Overview and Configuration Guide](#).

Syntax `show bgp ipv6 paths`

Mode User Exec and Privileged Exec

Example `awplus# show bgp ipv6 paths`

Related commands [show ip bgp paths \(BGP only\)](#)

Command changes

- Added to AlliedWare Plus prior to 5.4.6-1
- Version 5.4.7-2.1: BGP support added for IEx510, x550 series
- Version 5.4.7-2.4: BGP support added for IE300 series

show bgp ipv6 prefix-list (BGP4+ only)

Overview Use this command to display routes matching the prefix-list within an IPv6 environment. Use the [show ip bgp prefix-list \(BGP only\)](#) command to display routes matching the prefix-list within an IPv4 environment.

For information on filtering and saving command output, see the [“Getting Started with AlliedWare Plus” Feature Overview and Configuration Guide](#).

Syntax `show bgp ipv6 prefix-list <list>`

Parameter	Description
<list>	Specifies the name of the IPv6 prefix list.

Mode User Exec and Privileged Exec

Example `awplus# show bgp ipv6 prefix-list mylist`

Related commands [show ip bgp prefix-list \(BGP only\)](#)

Command changes
Added to AlliedWare Plus prior to 5.4.6-1
Version 5.4.7-2.1: BGP support added for IEx510, x550 series
Version 5.4.7-2.4: BGP support added for IE300 series

show bgp ipv6 quote-regexp (BGP4+ only)

Overview Use this command to display routes matching the AS path regular expression within an IPv6 environment. Use the [show ip bgp quote-regexp \(BGP only\)](#) command to display routes matching the AS path regular expression within an IPv4 environment.

Note that you must use quotes to enclose the regular expression with this command. Use the regular expressions listed below with the *<expression>* parameter:

Symbol	Character	Meaning
^	Caret	Used to match the beginning of the input string. When used at the beginning of a string of characters, it negates a pattern match.
\$	Dollar sign	Used to match the end of the input string.
.	Period	Used to match a single character (white spaces included).
*	Asterisk	Used to match none or more sequences of a pattern.
+	Plus sign	Used to match one or more sequences of a pattern.
?	Question mark	Used to match none or one occurrence of a pattern.
_	Underscore	Used to match spaces, commas, braces, parenthesis, or the beginning and end of an input string.
[]	Brackets	Specifies a range of single-characters.
-	Hyphen	Separates the end points of a range.

For information on filtering and saving command output, see the [“Getting Started with AlliedWare Plus” Feature Overview and Configuration Guide](#).

Syntax `show bgp ipv6 quote-regexp <expression>`

Mode User Exec and Privileged Exec

Example `awplus# show bgp ipv6 quote-regexp myexpression`

Related commands [show ip bgp quote-regexp \(BGP only\)](#)

Command changes Added to AlliedWare Plus prior to 5.4.6-1
Version 5.4.7-2.1: BGP support added for IEx510, x550 series
Version 5.4.7-2.4: BGP support added for IE300 series

show bgp ipv6 regexp (BGP4+ only)

Overview Use this command to display routes matching the AS path regular expression within an IPv6 environment. Use the [show ip bgp regexp \(BGP only\)](#) command to display routes matching the AS path regular expression within an IPv4 environment.

Use the regular expressions listed below with the *<expression>* parameter:

Symbol	Character	Meaning
^	Caret	Used to match the beginning of the input string. When used at the beginning of a string of characters, it negates a pattern match.
\$	Dollar sign	Used to match the end of the input string.
.	Period	Used to match a single character (white spaces included).
*	Asterisk	Used to match none or more sequences of a pattern.
+	Plus sign	Used to match one or more sequences of a pattern.
?	Question mark	Used to match none or one occurrence of a pattern.
_	Underscore	Used to match spaces, commas, braces, parenthesis, or the beginning and end of an input string.
[]	Brackets	Specifies a range of single-characters.
-	Hyphen	Separates the end points of a range.

For information on filtering and saving command output, see the [“Getting Started with AlliedWare Plus” Feature Overview and Configuration Guide](#).

Syntax `show bgp ipv6 regexp <expression>`

Parameter	Description
<i><expression></i>	Specifies a regular-expression to match the BGP4+ AS paths.

Mode User Exec and Privileged Exec

Example `awplus# show bgp ipv6 regexp myexpression`

Related commands [show ip bgp regexp \(BGP only\)](#)

Command changes Added to AlliedWare Plus prior to 5.4.6-1
Version 5.4.7-2.1: BGP support added for IEx510, x550 series

Version 5.4.7-2.4: BGP support added for IE300 series

show bgp ipv6 route-map (BGP4+ only)

Overview Use this command to display BGP4+ routes that match the specified route-map within an IPv6 environment. Use the [show ip bgp route-map \(BGP only\)](#) command to display BGP routes that match the specified route-map within an IPv4 environment.

For information on filtering and saving command output, see the [“Getting Started with AlliedWare Plus” Feature Overview and Configuration Guide](#).

Syntax `show bgp ipv6 route-map <route-map>`

Parameter	Description
<code><route-map></code>	Specifies a route-map that is matched.

Mode User Exec and Privileged Exec

Example To show routes that match the route-map `myRouteMap`, use the command:

```
awplus# show bgp ipv6 route-map myRouteMap
```

Related commands [show ip bgp route-map \(BGP only\)](#)

Command changes Added to AlliedWare Plus prior to 5.4.6-1
Version 5.4.7-2.1: BGP support added for IEx510, x550 series
Version 5.4.7-2.4: BGP support added for IE300 series

show bgp ipv6 summary (BGP4+ only)

Overview Use this command to display a summary of a BGP4+ neighbor status within an IPv6 environment. Use the [show ip bgp summary \(BGP only\)](#) command to display a summary of a BGP neighbor status within an IPv4 environment.

For information on filtering and saving command output, see the [“Getting Started with AlliedWare Plus” Feature Overview and Configuration Guide](#).

Syntax show bgp ipv6 summary

Mode User Exec and Privileged Exec

Example awplus# show bgp ipv6 summary

Output Figure 29-5: Example output from the **show ip bgp summary** command

```
awplus>show ip bgp summary

BGP router identifier 1.0.0.1, local AS number 65541
BGP table version is 12
4 BGP AS-PATH entries
0 BGP community entries

Neighbor          V      AS   MsgRc  MsgSnt  TblVer  InOutQ  Up/Down  State/PfxRcd
2001:0db8:cccc::1 4      65544   20     24     11 0/0   00:07:19      1
2001:0db8:dddd::1 4      65545    0      0      0 0/0   never         Active
2001:0db8:eeee::1 4      65542   34     40      0 0/0   00:00:04     Active
2001:0db8:ffff::1 4      65543   29     32     11 0/0   00:07:03     13

Number of neighbors 4
```

The Up/Down column in this output is a timer that shows:

- "never" if the peer session has never been established
- The up time, if the peer session is currently up
- The down time, if the peer session is currently down.

In the example above, the session with 2001:0db8:eeee::1 has been down for 4 seconds, and the session with 2001:0db8:dddd::1 has never been established.

Related commands [show ip bgp summary \(BGP only\)](#)

Command changes Added to AlliedWare Plus prior to 5.4.6-1
Version 5.4.7-2.1: BGP support added for IEx510, x550 series
Version 5.4.7-2.4: BGP support added for IE300 series

show bgp memory maxallocation (BGP only)

Overview This command displays the maximum percentage of total memory that is allocated to BGP processes.

For information on filtering and saving command output, see the [“Getting Started with AlliedWare Plus” Feature Overview and Configuration Guide](#).

Syntax `show bgp memory maxallocation`

Mode User Exec and Privileged Exec

Example To display the maximum amount of memory allocated for BGP processes, use the command:

```
awplus# show bgp memory maxallocation
```

Output Figure 29-6: Example output from the **show bgp memory maxallocation** command

```
BGP maximum RAM allocation is 100%
```

Command changes

- Added to AlliedWare Plus prior to 5.4.6-1
- Version 5.4.7-2.1: BGP support added for IEx510, x550 series
- Version 5.4.7-2.4: BGP support added for IE300 series

show bgp nexthop-tracking (BGP only)

Overview Use this command to display BGP next hop tracking status.

Syntax `show bgp nexthop-tracking`

Mode User Exec and Privileged Exec

Example To display BGP next hop tracking status, use the command:

```
awplus# show bgp nexthop-tracking
```

Related commands [bgp nexthop-trigger-count](#)
[show bgp nexthop-tree-details \(BGP only\)](#)

Command changes Added to AlliedWare Plus prior to 5.4.6-1
Version 5.4.7-2.1: BGP support added for IEx510, x550 series
Version 5.4.7-2.4: BGP support added for IE300 series

show bgp nexthop-tree-details (BGP only)

Overview Use this command to display BGP next hop tree details.

Syntax `show bgp nexthop-tree-details`

Mode User Exec and Privileged Exec

Example To display BGP next hop tree details, use the command:

```
awplus# show bgp nexthop-tree-details
```

Related commands [show bgp nexthop-tracking \(BGP only\)](#)

Command changes

- Added to AlliedWare Plus prior to 5.4.6-1
- Version 5.4.7-2.1: BGP support added for IEx510, x550 series
- Version 5.4.7-2.4: BGP support added for IE300 series

show debugging bgp (BGP only)

Overview Use this command to see what debugging is turned on for BGP.
For information on filtering and saving command output, see the [“Getting Started with AlliedWare Plus” Feature Overview and Configuration Guide](#).

Syntax `show debugging bgp`

Mode User Exec and Privileged Exec

Example `awplus# show debugging bgp`

Output Figure 29-7: Example output from the **show debugging bgp** command

```
BGP debugging status:
  BGP debugging is on
  BGP events debugging is on
  BGP updates debugging is on
  BGP fsm debugging is on
```

Related commands [debug bgp \(BGP only\)](#)

Command changes Added to AlliedWare Plus prior to 5.4.6-1
Version 5.4.7-2.1: BGP support added for IEx510, x550 series
Version 5.4.7-2.4: BGP support added for IE300 series

show ip bgp (BGP only)

Overview Use this command to display BGP network information.

For information on filtering and saving command output, see the [“Getting Started with AlliedWare Plus” Feature Overview and Configuration Guide](#).

Syntax `show ip bgp [<ip-addr>|<ip-addr/m>]`

Parameter	Description
<ip-addr>	Specifies the IPv4 address and the optional prefix mask length.
<ip-addr/m>	

Mode User Exec and Privileged Exec

Example `awplus# show ip bgp 10.10.1.34/24`

Output Figure 29-8: Example output from the **show ip bgp** command

```
BGP table version is 7, local router ID is 80.80.80.80
Status codes: s suppressed, d damped, h history, * valid, >
best, i - internal, S Stale
Origin codes: i - IGP, e - EGP, ? - incomplete

   Network          Next Hop          Metric LocPrf Weight
Path
S>i10.70.0.0/24    192.10.23.67      0      100      0 ?
S>i30.30.30.30/32  192.10.23.67      0      100      0 ?
S>i63.63.63.1/32   192.10.23.67      0      100      0 ?
S>i67.67.67.67/32  192.10.23.67      0      100      0 ?
S>i172.22.10.0/24  192.10.23.67      0      100      0 ?
S>i192.10.21.0     192.10.23.67      0      100      0 ?
S>i192.10.23.0     192.10.23.67      0      100      0 ?

Total number of prefixes 7
```

Related commands [neighbor remove-private-AS \(BGP only\)](#)

Command changes Added to AlliedWare Plus prior to 5.4.6-1
Version 5.4.7-2.1: BGP support added for IEx510, x550 series
Version 5.4.7-2.4: BGP support added for IE300 series

show ip bgp attribute-info (BGP only)

Overview Use this command to show internal attribute hash information.
For information on filtering and saving command output, see the [“Getting Started with AlliedWare Plus” Feature Overview and Configuration Guide](#).

Syntax `show ip bgp attribute-info`

Mode User Exec and Privileged Exec

Example `awplus# show ip bgp attribute-info`

Output Figure 29-9: Example output from the **show ip bgp attribute-info** command

```
attr[1] nexthop 0.0.0.0
attr[1] nexthop 10.10.10.10
attr[1] nexthop 10.10.10.50
```

Command changes Added to AlliedWare Plus prior to 5.4.6-1
Version 5.4.7-2.1: BGP support added for IEx510, x550 series
Version 5.4.7-2.4: BGP support added for IE300 series

show ip bgp cidr-only (BGP only)

Overview Use this command to display routes with non-natural network masks.

For information on filtering and saving command output, see the [“Getting Started with AlliedWare Plus” Feature Overview and Configuration Guide](#).

Syntax `show ip bgp cidr-only`

Syntax (VRF-lite) `show ip bgp [global|vrf <vrf-name>] cidr-only`

Parameter	Description
global	When VRF-lite is configured, apply the command to the global routing and forwarding table.
vrf	Apply the command to the specified VRF instance.
<vrf-name>	The name of the VRF instance.

Mode User Exec and Privileged Exec

Example
`awplus# show ip bgp cidr-only`
`awplus# show ip bgp vrf red cidr-only`

Output Figure 29-10: Example output from the **show ip bgp cidr-only** command

```
BGP table version is 0, local router ID is 10.10.10.50

Status codes: s suppressed, d damped, h history, p stale, *
valid, > best, i - internal

Origin codes: i - IGP, e - EGP, ? - incomplete

   Network          Next Hop          Metric LocPrf Weight Path
*> 3.3.3.0/24      10.10.10.10              0 11 i
*> 6.6.6.0/24      0.0.0.0                32768 i

Total number of prefixes 2
```

Command changes Added to AlliedWare Plus prior to 5.4.6-1

Version 5.4.6-2.1: VRF-lite support added to BGP for AR-series products

Version 5.4.7-2.1: BGP support added for IEx510, x550 series

Version 5.4.7-2.4: BGP support added for IE300 series

show ip bgp community (BGP only)

Overview Use this command to display routes that match specified communities from a BGP instance within an IPv4 environment. Use the [show bgp ipv6 community \(BGP4+ only\)](#) command within an IPv6 environment.

For information on filtering and saving command output, see the [“Getting Started with AlliedWare Plus” Feature Overview and Configuration Guide](#).

You may use any combination and repetition of parameters listed in the *<type>* placeholder.

Syntax `show ip bgp community [<type>] [exact-match]`

Syntax (VRF-lite) `show ip bgp [global|vrf <vrf-name>] community [<type>] [exact-match]`

Parameter	Description
global	When VRF-lite is configured, apply the command to the global routing and forwarding table.
vrf	Apply the command to the specified VRF instance.
<i><vrf-name></i>	The name of the VRF instance.
<i><type></i>	{[<i>AA:NN</i>] [<i>local-AS</i>] [<i>no-advertise</i>] [<i>no-export</i>] }
<i>AA:NN</i>	Specifies the Autonomous System (AS) community number, in AA:NN format.
<i>local-AS</i>	Do not send outside local Autonomous Systems (well-known community).
<i>no-advertise</i>	Do not advertise to any peer (well-known community).
<i>no-export</i>	Do not export to next AS (well-known community).
<i>exact-match</i>	Specifies that the exact match of the communities is displayed. This optional parameter cannot be repeated.

Mode User Exec and Privileged Exec

Examples Note that the AS numbers shown are examples only.

```
awplus# show ip bgp community 64497:64499 exact-match
awplus# show ip bgp community 64497:64499 64500:64501
exact-match
awplus# show ip bgp community 64497:64499 64500:64501
64510:64511no-advertise
awplus# show ip bgp community no-advertise
no-advertiseno-advertise exact-match
awplus# show ip bgp community no-export 64510:64511
no-advertise local-AS no-export
awplus# show ip bgp community no-export 64510:64511
no-advertise 64497:64499 64500:64501 no-export
awplus# show ip bgp community no-export 64497:64499
no-advertise local-AS no-export
awplus# show ip bgp vrf red no-export
awplus# show ip bgp global 65500:2 65500:3 exact-match
```

Related commands [set community](#)
[show bgp ipv6 community \(BGP4+ only\)](#)

Command changes Added to AlliedWare Plus prior to 5.4.6-1
Version 5.4.6-2.1: VRF-lite support added to BGP for AR-series products
Version 5.4.7-2.1: BGP support added for IEx510, x550 series
Version 5.4.7-2.4: BGP support added for IE300 series

show ip bgp community-info (BGP only)

- Overview** Use this command to list all BGP community information.
For information on filtering and saving command output, see the [“Getting Started with AlliedWare Plus” Feature Overview and Configuration Guide](#).
- Syntax** `show ip bgp community-info`
- Mode** User Exec and Privileged Exec
- Example** `awplus# show ip bgp community-info`
- Command changes**
Added to AlliedWare Plus prior to 5.4.6-1
Version 5.4.7-2.1: BGP support added for IEx510, x550 series
Version 5.4.7-2.4: BGP support added for IE300 series

show ip bgp community-list (BGP only)

Overview Use this command to display routes that match the given community-list from a BGP instance within an IPv4 environment. Use the [show bgp ipv6 community-list \(BGP4+ only\)](#) command within an IPv6 environment.

For information on filtering and saving command output, see the [“Getting Started with AlliedWare Plus” Feature Overview and Configuration Guide](#).

Syntax `show ip bgp community-list <listname> [exact-match]`

Syntax (VRF-lite) `show ip bgp [global|vrf <vrf-name>] community-list <listname> [exact-match]`

Parameter	Description
global	When VRF-lite is configured, apply the command to the global routing and forwarding table.
vrf	Apply the command to the specified VRF instance.
<vrf-name>	The name of the VRF instance.
<listname>	Specifies the community list name.
exact-match	Displays only routes that have exactly the same specified communities.

Mode User Exec and Privileged Exec

Example

```
awplus# show ip bgp community-list mylist exact-match
awplus# show ip bgp vrf red community-list myCommunity
awplus# show ip bgp global community-list myExactCommunity
exact-match
```

Related commands [show bgp ipv6 community-list \(BGP4+ only\)](#)

Command changes

- Added to AlliedWare Plus prior to 5.4.6-1
- Version 5.4.6-2.1: VRF-lite support added to BGP for AR-series products
- Version 5.4.7-2.1: BGP support added for IEx510, x550 series
- Version 5.4.7-2.4: BGP support added for IE300 series

show ip bgp dampening (BGP only)

Overview Use this command to show dampened routes from a BGP instance within an IPv4 environment. Use the [show bgp ipv6 dampening \(BGP4+ only\)](#) command within an IPv6 environment.

For information on filtering and saving command output, see the [“Getting Started with AlliedWare Plus” Feature Overview and Configuration Guide](#).

Syntax `show ip bgp dampening
{dampened-paths|flap-statistics|parameters}`

Syntax (VRF-lite) `show ip bgp [global|vrf <vrf-name>] dampening
{dampened-paths|flap-statistics|parameters}`

Parameter	Description
global	When VRF-lite is configured, apply the command to the global routing and forwarding table.
vrf	Apply the command to the specified VRF instance.
<vrf-name>	The name of the VRF instance.
dampened-paths	Display paths suppressed due to dampening.
flap-statistics	Display flap statistics of routes.
parameters	Display details of configured dampening parameters.

Mode User Exec and Privileged Exec

Usage notes Enable BGP dampening to maintain dampened-path information in memory.

Examples `awplus# show ip bgp dampening dampened-paths
awplus# show ip bgp vrf red dampening dampened-paths
awplus# show ip bgp global dampening flap-statistics`

Output Figure 29-11: Example output from the **show ip bgp dampening** command

```
dampening 15 750 2000 60 15
  Reachability Half-Life time      : 15 min
  Reuse penalty                    : 750
  Suppress penalty                 : 2000
  Max suppress time                : 60 min
  Un-reachability Half-Life time   : 15 min
  Max penalty (ceil)               : 11999
  Min penalty (floor)              : 375
```

The following example output shows that the internal route (i), has flapped 3 times and is now categorized as history (h).

Figure 29-12: Example output from the **show ip bgp dampening flap-statistics** command

```
awplus# show ip bgp dampening flap-statistics
BGP table version is 1, local router ID is 30.30.30.77
Status codes: s suppressed, d damped, h history, * valid, > best, i - internal, S
Stale
Origin codes: i - IGP, e - EGP, ? - incomplete
  Network          From           Flaps  Duration  Reuse    Path
  ----          -
hi1.1.1.0/24     10.100.0.62      3  00:01:20      i
```

The following example output shows a dampened route in the 1.1.1.0/24 network.

Figure 29-13: Example output from the **show ip bgp dampening dampened-path** command

```
awplus# show ip bgp dampening dampened-paths
BGP table version is 1, local router ID is 30.30.30.77
Status codes: s suppressed, d damped, h history, * valid, > best, i - internal, S
Stale
Origin codes: i - IGP, e - EGP, ? - incomplete
  Network          From           Reuse    Path
  ----          -
di 1.1.1.0/24     10.100.0.62      00:35:10  i

Total number of prefixes 1
```

Related commands [show bgp ipv6 dampening \(BGP4+ only\)](#)

Command changes
Added to AlliedWare Plus prior to 5.4.6-1
Version 5.4.6-2.1: VRF-lite support added to BGP for AR-series products
Version 5.4.7-2.1: BGP support added for IEx510, x550 series
Version 5.4.7-2.4: BGP support added for IE300 series

show ip bgp filter-list (BGP only)

Overview Use this command to display routes conforming to the filter-list within an IPv4 environment. Use the [show bgp ipv6 filter-list \(BGP4+ only\)](#) command to display routes conforming to the filter-list within an IPv6 environment

For information on filtering and saving command output, see the [“Getting Started with AlliedWare Plus” Feature Overview and Configuration Guide](#).

Syntax `show ip bgp filter-list <listname>`

Syntax (VRF-lite) `show ip bgp [global|vrf <vrf-name>] filter-list <listname>`

Parameter	Description
global	When VRF-lite is configured, apply the command to the global routing and forwarding table.
vrf	Apply the command to the specified VRF instance.
<vrf-name>	The name of the VRF instance.
<listname>	Specifies the regular-expression access list name.

Mode User Exec and Privileged Exec

Example
`awplus# show ip bgp filter-list mylist`
`awplus# show ip bgp vrf red filter-list mylist`

Related commands [show bgp ipv6 filter-list \(BGP4+ only\)](#)

Command changes
Added to AlliedWare Plus prior to 5.4.6-1
Version 5.4.6-2.1: VRF-lite support added to BGP for AR-series products
Version 5.4.7-2.1: BGP support added for IEx510, x550 series
Version 5.4.7-2.4: BGP support added for IE300 series

show ip bgp inconsistent-as (BGP only)

Overview Use this command to display routes with inconsistent AS Paths within an IPv4 environment. Use the [show bgp ipv6 inconsistent-as \(BGP4+ only\)](#) command to display routes with inconsistent AS paths within an IPv6 environment.

For information on filtering and saving command output, see the [“Getting Started with AlliedWare Plus” Feature Overview and Configuration Guide](#).

Syntax `show ip bgp inconsistent-as`

Syntax (VRF-lite) `show ip bgp [global|vrf <vrf-name>] inconsistent-as`

Parameter	Description
global	When VRF-lite is configured, apply the command to the global routing and forwarding table.
vrf	Apply the command to the specified VRF instance.
<vrf-name>	The name of the VRF instance.

Mode User Exec and Privileged Exec

Example
`awplus# show ip bgp inconsistent-as`
`awplus# show ip bgp global inconsistent-as`

Related commands [show bgp ipv6 inconsistent-as \(BGP4+ only\)](#)

Command changes
Added to AlliedWare Plus prior to 5.4.6-1
Version 5.4.6-2.1: VRF-lite support added to BGP for AR-series products
Version 5.4.7-2.1: BGP support added for IEx510, x550 series
Version 5.4.7-2.4: BGP support added for IE300 series

show ip bgp longer-prefixes (BGP only)

Overview Use this command to display the route of the local BGP routing table for a specific prefix with a specific mask, or for any prefix having a longer mask than the one specified.

For information on filtering and saving command output, see the [“Getting Started with AlliedWare Plus” Feature Overview and Configuration Guide](#).

Syntax `show ip bgp <ip-address/m> longer-prefixes`

Syntax (VRF-lite) `show ip bgp [global|vrf <vrf-name>] <ip-address/m> longer-prefixes`

Parameter	Description
global	When VRF-lite is configured, apply the command to the global routing and forwarding table.
vrf	Apply the command to the specified VRF instance.
<vrf-name>	The name of the VRF instance.
<ip-address/m>	Neighbor’s IP address and subnet mask, entered in the form A.B.C.D/M, where M is the subnet mask length.

Mode User Exec and Privileged Exec

Example

```
awplus# show ip bgp 10.10.0.10/24 longer-prefixes
awplus# show ip bgp vrf red 172.16.4.0/24
awplus# show ip bgp global 172.16.0.0/16 longer-prefixes
```

Command changes

- Added to AlliedWare Plus prior to 5.4.6-1
- Version 5.4.6-2.1: VRF-lite support added to BGP for AR-series products
- Version 5.4.7-2.1: BGP support added for IEx510, x550 series
- Version 5.4.7-2.4: BGP support added for IE300 series

show ip bgp neighbors (BGP only)

Overview Use this command to display detailed information on peering connections to all BGP neighbors within an IPv4 environment.

Use the [show bgp ipv6 neighbors \(BGP4+ only\)](#) command to display detailed information on peering connections to all BGP4+ neighbors within an IPv6 environment.

For information on filtering and saving command output, see the [“Getting Started with AlliedWare Plus” Feature Overview and Configuration Guide](#).

Syntax [BGP] `show ip bgp neighbors [<ipv4-addr> [advertised-routes|received prefix-filter|received-routes|routes]]`

Syntax (VRF-lite) `show ip bgp [global|vrf <vrf-name>] neighbors [<ipv4-addr> routes]`

Parameter	Description
<ipv4-addr>	The IPv4 address of an IPv4 BGP neighbor, in dotted decimal notation A.B.C.D.
advertised-routes	Displays the routes advertised to a BGP neighbor.
received prefix-filter	Displays the received prefix-list filters.
received-routes	Displays the received routes from the neighbor. To display all the received routes from the neighbor, configure the BGP soft reconfigure first.
routes	Displays all accepted routes learned from neighbors.
global	When VRF-lite is configured, apply the command to the global routing and forwarding table.
vrf	Apply the command to the specified VRF instance.
<vrf-name>	The name of the VRF instance.

Mode [BGP] User Exec and Privileged Exec

Examples [BGP]

```
awplus# show ip bgp neighbors 10.10.10.72 advertised-routes
awplus# show ip bgp neighbors 10.10.10.72 received
prefix-filter
awplus# show ip bgp neighbors 10.10.10.72 received-routes
awplus# show ip bgp neighbors 10.10.10.72 routes
```

Output Figure 29-14: Example output from **show ip bgp neighbors 10.10.10.72**

```
awplus#show ip bgp neighbors 10.10.10.72
BGP neighbor is 10.10.10.72, remote AS 100, local AS 100, internal
link
Member of peer-group group1 for session parameters
  BGP version 4, remote router ID 0.0.0.0
  BGP state = Active
  Last read          , hold time is 90, keepalive interval is 30 seconds
  Received 0 messages, 0 notifications, 0 in queue
  Sent 0 messages, 0 notifications, 0 in queue
  Route refresh request: received 0, sent 0
  Minimum time between advertisement runs is 5 seconds
For address family: IPv4 Unicast
  BGP table version 1, neighbor version 0
  Index 1, Offset 0, Mask 0x2
  group1 peer-group member
  NEXT_HOP is always this router
  0 accepted prefixes
  0 announced prefixes

Connections established 0; dropped 0
Next connect timer due in 33 seconds
```

If available the following is shown:

- Session information
 - Neighbor address, ASN information and if the link is external or internal
 - BGP version and status
 - Neighbor capabilities for the BGP session
 - Number of messages transmitted and received
- IPv4 unicast address family information
 - BGP table version
 - IPv4 Address Family dependent capabilities
 - IPv4 Communities
 - IPv4 Route filters for ingress and egress updates
 - Number of announced and accepted IPv4 prefixes
- Connection information
 - Connection counters
 - Graceful restart timer
 - Hop count to the peer
 - Next hop information
 - Local and external port numbers

Related commands [show bgp ipv6 neighbors \(BGP4+ only\)](#)

Command changes

- Added to AlliedWare Plus prior to 5.4.6-1
- Version 5.4.6-2.1: VRF-lite support added to BGP for AR-series products
- Version 5.4.7-2.1: BGP support added for IEx510, x550 series
- Version 5.4.7-2.4: BGP support added for IE300 series

show ip bgp neighbors connection-retrytime (BGP only)

Overview Use this command to display the configured connection-retrytime value of the peer at the session establishment time with the neighbor.

For information on filtering and saving command output, see the [“Getting Started with AlliedWare Plus” Feature Overview and Configuration Guide](#).

Syntax `show ip bgp neighbors <ipv4-addr> connection-retrytime`

Parameter	Description
<code><ipv4-addr></code>	The IPv4 address of an IPv4 BGP neighbor, in dotted decimal notation A.B.C.D.

Mode User Exec and Privileged Exec

Example `awplus# show ip bgp neighbors 10.11.4.26 connection-retrytime`

Command changes Added to AlliedWare Plus prior to 5.4.6-1
Version 5.4.7-2.1: BGP support added for IEx510, x550 series
Version 5.4.7-2.4: BGP support added for IE300 series

show ip bgp neighbors hold-time (BGP only)

Overview Use this command to display the configured holdtime value of the peer at the session establishment time with the neighbor.

For information on filtering and saving command output, see the [“Getting Started with AlliedWare Plus” Feature Overview and Configuration Guide](#).

Syntax `show ip bgp neighbors <ipv4-addr> hold-time`

Parameter	Description
<code><ipv4-addr></code>	The IPv4 address of an IPv4 BGP neighbor, in dotted decimal notation A.B.C.D.

Default The holdtime timer default is 90 seconds as per RFC 4271. Holdtime is `keepalive * 3`.

Mode User Exec and Privileged Exec

Examples `awplus# show ip bgp neighbors 10.11.4.26 hold-time`

Related commands [neighbor timers](#)
[show ip bgp neighbors keepalive-interval \(BGP only\)](#)
[timers \(BGP\)](#)

Command changes Added to AlliedWare Plus prior to 5.4.6-1
Version 5.4.7-2.1: BGP support added for IEx510, x550 series
Version 5.4.7-2.4: BGP support added for IE300 series

show ip bgp neighbors keepalive (BGP only)

Overview Use this command to display the number of keepalive messages sent to the neighbor from the peer throughout the session.

For information on filtering and saving command output, see the [“Getting Started with AlliedWare Plus” Feature Overview and Configuration Guide](#).

Syntax `show ip bgp neighbors <ipv4-addr> keepalive`

Parameter	Description
<code><ipv4-addr></code>	The IPv4 address of an IPv4 BGP neighbor, in dotted decimal notation A.B.C.D.

Mode User Exec and Privileged Exec

Examples `awplus# show ip bgp neighbors 10.11.4.26 keepalive`

Related commands [show ip bgp neighbors keepalive-interval \(BGP only\)](#)

Command changes
Added to AlliedWare Plus prior to 5.4.6-1
Version 5.4.7-2.1: BGP support added for IEx510, x550 series
Version 5.4.7-2.4: BGP support added for IE300 series

show ip bgp neighbors keepalive-interval (BGP only)

Overview Use this command to display the configured keepalive-interval value of the peer at the session establishment time with the neighbor.

For information on filtering and saving command output, see the [“Getting Started with AlliedWare Plus” Feature Overview and Configuration Guide](#).

Syntax `show ip bgp neighbors <ipv4-addr> keepalive-interval`

Parameter	Description
<code><ipv4-addr></code>	The IPv4 address of an IPv4 BGP neighbor, in dotted decimal notation A.B.C.D.

Default The keepalive timer default is 60 seconds as per RFC 4271. Keepalive is holdtime / 3.

Mode User Exec and Privileged Exec

Examples `awplus# show ip bgp neighbors 10.11.4.26 keepalive-interval`

Related commands [neighbor timers](#)
[show ip bgp neighbors hold-time \(BGP only\)](#)
[timers \(BGP\)](#)

Command changes Added to AlliedWare Plus prior to 5.4.6-1
Version 5.4.7-2.1: BGP support added for IEx510, x550 series
Version 5.4.7-2.4: BGP support added for IE300 series

show ip bgp neighbors notification (BGP only)

Overview Use this command to display the number of notification messages sent to the neighbor from the peer throughout the session.

For information on filtering and saving command output, see the [“Getting Started with AlliedWare Plus” Feature Overview and Configuration Guide](#).

Syntax `show ip bgp neighbors <ipv4-addr> notification`

Parameter	Description
<code><ipv4-addr></code>	The IPv4 address of an IPv4 BGP neighbor, in dotted decimal notation A.B.C.D.

Mode User Exec and Privileged Exec

Example `awplus# show ip bgp neighbors 10.11.4.26 notification`

Command changes Added to AlliedWare Plus prior to 5.4.6-1
Version 5.4.7-2.1: BGP support added for IEx510, x550 series
Version 5.4.7-2.4: BGP support added for IE300 series

show ip bgp neighbors open (BGP only)

Overview Use this command to display the number of open messages sent to the neighbor from the peer throughout the session.

For information on filtering and saving command output, see the [“Getting Started with AlliedWare Plus” Feature Overview and Configuration Guide](#).

Syntax `show ip bgp neighbors <ipv4-addr> open`

Parameter	Description
<code><ipv4-addr></code>	The IPv4 address of an IPv4 BGP neighbor, in dotted decimal notation A.B.C.D.

Mode User Exec and Privileged Exec

Example `awplus# show ip bgp neighbors 10.11.4.26 open`

Command changes Added to AlliedWare Plus prior to 5.4.6-1
Version 5.4.7-2.1: BGP support added for IEx510, x550 series
Version 5.4.7-2.4: BGP support added for IE300 series

show ip bgp neighbors rcvd-msgs (BGP only)

Overview Use this command to display the number of messages received by the neighbor from the peer throughout the session.

For information on filtering and saving command output, see the [“Getting Started with AlliedWare Plus” Feature Overview and Configuration Guide](#).

Syntax `show ip bgp neighbors <ipv4-addr> rcvd-msgs`

Parameter	Description
<code><ipv4-addr></code>	The IPv4 address of an IPv4 BGP neighbor, in dotted decimal notation A.B.C.D.

Mode User Exec and Privileged Exec

Example `awplus# show ip bgp neighbors 10.11.4.26 rcvd-msgs`

Command changes
Added to AlliedWare Plus prior to 5.4.6-1
Version 5.4.7-2.1: BGP support added for IEx510, x550 series
Version 5.4.7-2.4: BGP support added for IE300 series

show ip bgp neighbors sent-msgs (BGP only)

Overview Use this command to display the number of messages sent to the neighbor from the peer throughout the session.

For information on filtering and saving command output, see the [“Getting Started with AlliedWare Plus” Feature Overview and Configuration Guide](#).

Syntax `show ip bgp neighbors <ipv4-addr> sent-msgs`

Parameter	Description
<code><ipv4-addr></code>	The IPv4 address of an IPv4 BGP neighbor, in dotted decimal notation A.B.C.D.

Mode User Exec and Privileged Exec

Example `awplus# show ip bgp neighbors 10.11.4.26 sent-msgs`

Command changes Added to AlliedWare Plus prior to 5.4.6-1
Version 5.4.7-2.1: BGP support added for IEx510, x550 series
Version 5.4.7-2.4: BGP support added for IE300 series

show ip bgp neighbors update (BGP only)

Overview Use this command to display the number of update messages sent to the neighbor from the peer throughout the session.

For information on filtering and saving command output, see the [“Getting Started with AlliedWare Plus” Feature Overview and Configuration Guide](#).

Syntax `show ip bgp neighbors <ipv4-addr> update`

Parameter	Description
<code><ipv4-addr></code>	The IPv4 address of an IPv4 BGP neighbor, in dotted decimal notation A.B.C.D.

Mode User Exec and Privileged Exec

Example `awplus# show ip bgp neighbors 10.11.4.26 update`

Command changes Added to AlliedWare Plus prior to 5.4.6-1
Version 5.4.7-2.1: BGP support added for IEx510, x550 series
Version 5.4.7-2.4: BGP support added for IE300 series

show ip bgp paths (BGP only)

Overview Use this command to display BGP4 path information within an IPv4 environment. Use the [show bgp ipv6 paths \(BGP4+ only\)](#) command to display BGP4+ path information within an IPv4 environment.

For information on filtering and saving command output, see the [“Getting Started with AlliedWare Plus” Feature Overview and Configuration Guide](#).

Syntax `show ip bgp paths`

Mode User Exec and Privileged Exec

Example `awplus# show ip bgp paths`

Related commands [show bgp ipv6 paths \(BGP4+ only\)](#)

Command changes Added to AlliedWare Plus prior to 5.4.6-1
Version 5.4.7-2.1: BGP support added for IEx510, x550 series
Version 5.4.7-2.4: BGP support added for IE300 series

show ip bgp prefix-list (BGP only)

Overview Use this command to display routes matching the prefix-list within an IPv4 environment. Use the [show bgp ipv6 prefix-list \(BGP4+ only\)](#) command to display routes matching the prefix-list within an IPv6 environment.

For information on filtering and saving command output, see the [“Getting Started with AlliedWare Plus” Feature Overview and Configuration Guide](#).

Syntax `show ip bgp prefix-list <list>`

Syntax (VRF-lite) `show ip bgp [global|vrf <vrf-name>] prefix-list <list>`

Parameter	Description
global	When VRF-lite is configured, apply the command to the global routing and forwarding table.
vrf	Apply the command to the specified VRF instance.
<vrf-name>	The name of the VRF instance.
<list>	Specifies the name of the IP prefix list.

Mode User Exec and Privileged Exec

Examples
`awplus# show ip bgp prefix-list mylist`
`awplus# show ip bgp vrf red prefix-list myPrefixes`

Related commands [show bgp ipv6 prefix-list \(BGP4+ only\)](#)

Command changes
Added to AlliedWare Plus prior to 5.4.6-1
Version 5.4.6-2.1: VRF-lite support added to BGP for AR-series products
Version 5.4.7-2.1: BGP support added for IEx510, x550 series
Version 5.4.7-2.4: BGP support added for IE300 series

show ip bgp quote-regexp (BGP only)

Overview Use this command to display routes matching the AS path regular expression within an IPv4 environment. Use the [show bgp ipv6 quote-regexp \(BGP4+ only\)](#) command to display routes matching the AS path regular expression within an IPv6 environment.

Note that you must use quotes to enclose the regular expression with this command. Use the regular expressions listed below with the *<expression>* parameter:

Symbol	Character	Meaning
^	Caret	Used to match the beginning of the input string. When used at the beginning of a string of characters, it negates a pattern match.
\$	Dollar sign	Used to match the end of the input string.
.	Period	Used to match a single character (white spaces included).
*	Asterisk	Used to match none or more sequences of a pattern.
+	Plus sign	Used to match one or more sequences of a pattern.
?	Question mark	Used to match none or one occurrence of a pattern.
_	Underscore	Used to match spaces, commas, braces, parenthesis, or the beginning and end of an input string.
[]	Brackets	Specifies a range of single-characters.
-	Hyphen	Separates the end points of a range.

For information on filtering and saving command output, see the [“Getting Started with AlliedWare Plus” Feature Overview and Configuration Guide](#).

Syntax `show ip bgp quote-regexp <expression>`

Syntax (VRF-lite) `show ip bgp [global|vrf <vrf-name>] quote-regexp <expression>`

Parameter	Description
global	When VRF-lite is configured, apply the command to the global routing and forwarding table.
vrf	Apply the command to the specified VRF instance.
<vrf-name>	The name of the VRF instance.
<expression>	Specifies a regular-expression to match the BGP AS paths.

Mode User Exec and Privileged Exec

Examples awplus# show ip bgp quote-regexp myexpression
awplus# show ip bgp global quote-regexp 65550 65555

Related commands [show bgp ipv6 quote-regexp \(BGP4+ only\)](#)

Command changes Added to AlliedWare Plus prior to 5.4.6-1
Version 5.4.6-2.1: VRF-lite support added to BGP for AR-series products
Version 5.4.7-2.1: BGP support added for IEx510, x550 series
Version 5.4.7-2.4: BGP support added for IE300 series

show ip bgp regexp (BGP only)

Overview Use this command to display routes matching the AS path regular expression within an IPv4 environment. Use the [show bgp ipv6 regexp \(BGP4+ only\)](#) command to display routes matching the AS path regular expression within an IPv6 environment.

Use the regular expressions listed below with the *<expression>* parameter:

Symbol	Character	Meaning
^	Caret	Used to match the beginning of the input string. When used at the beginning of a string of characters, it negates a pattern match.
\$	Dollar sign	Used to match the end of the input string.
.	Period	Used to match a single character (white spaces included).
*	Asterisk	Used to match none or more sequences of a pattern.
+	Plus sign	Used to match one or more sequences of a pattern.
?	Question mark	Used to match none or one occurrence of a pattern.
_	Underscore	Used to match spaces, commas, braces, parenthesis, or the beginning and end of an input string.
[]	Brackets	Specifies a range of single-characters.
-	Hyphen	Separates the end points of a range.

For information on filtering and saving command output, see the [“Getting Started with AlliedWare Plus” Feature Overview and Configuration Guide](#).

Syntax `show ip bgp regexp <expression>`

Syntax (VRF-lite) `show ip bgp [global|vrf <vrf-name>] regexp <expression>`

Parameter	Description
global	When VRF-lite is configured, apply the command to the global routing and forwarding table.
vrf	Apply the command to the specified VRF instance.
<vrf-name>	The name of the VRF instance.
<expression>	Specifies a regular-expression to match the BGP AS paths.

Mode User Exec and Privileged Exec

Examples awplus# show ip bgp regexp myexpression
awplus# show ip bgp vrf red regexp 65550 65555

Related commands [show bgp ipv6 regexp \(BGP4+ only\)](#)

Command changes Added to AlliedWare Plus prior to 5.4.6-1
Version 5.4.6-2.1: VRF-lite support added to BGP for AR-series products
Version 5.4.7-2.1: BGP support added for IEx510, x550 series
Version 5.4.7-2.4: BGP support added for IE300 series

show ip bgp route-map (BGP only)

Overview Use this command to display BGP routes that match the specified route-map within an IPv4 environment. Use the [show bgp ipv6 route-map \(BGP4+ only\)](#) command to display BGP4+ routes that match the specified route-map within an IPv6 environment.

For information on filtering and saving command output, see the [“Getting Started with AlliedWare Plus” Feature Overview and Configuration Guide](#).

Syntax `show ip bgp route-map <route-map>`

Syntax (VRF-lite) `show ip bgp [global|vrf <vrf-name>] route-map <route-map>`

Parameter	Description
global	When VRF-lite is configured, apply the command to the global routing and forwarding table.
vrf	Apply the command to the specified VRF instance.
<vrf-name>	The name of the VRF instance.
<route-map>	Specifies a route-map that is matched.

Mode User Exec and Privileged Exec

Examples To show routes that match the route-map `myRouteMap` for the global routing instance, use the command:

```
awplus# show ip bgp global route-map myRouteMap
```

To show routes that match the route-map `myRouteMap`, use the command:

```
awplus# show ip bgp route-map myRouteMap
```

Related commands [show bgp ipv6 route-map \(BGP4+ only\)](#)

Command changes

- Added to AlliedWare Plus prior to 5.4.6-1
- Version 5.4.6-2.1: VRF-lite support added to BGP for AR-series products
- Version 5.4.7-2.1: BGP support added for IEx510, x550 series
- Version 5.4.7-2.4: BGP support added for IE300 series

show ip bgp scan (BGP only)

Overview Use this command to display BGP scan status.

For information on filtering and saving command output, see the [“Getting Started with AlliedWare Plus” Feature Overview and Configuration Guide](#).

Syntax `show ip bgp scan`

Mode User Exec and Privileged Exec

Example `awplus# show ip bgp scan`

Output Figure 29-15: Example output from the **show ip bgp scan** command

```
BGP scan is running
BGP scan interval is 60
BGP instance : AS is 11,DEFAULT
Current BGP nexthop cache:
BGP connected route:
 10.10.10.0/24
 10.10.11.0/24
```

Command changes Added to AlliedWare Plus prior to 5.4.6-1

Version 5.4.7-2.1: BGP support added for IEx510, x550 series

Version 5.4.7-2.4: BGP support added for IE300 series

show ip bgp summary (BGP only)

Overview Use this command to display a summary of a BGP neighbor status within an IPv4 environment. Use the [show bgp ipv6 summary \(BGP4+ only\)](#) command to display a summary of BGP4+ neighbors.

For information on filtering and saving command output, see the [“Getting Started with AlliedWare Plus” Feature Overview and Configuration Guide](#).

Syntax `show ip bgp summary`

Syntax (VRF-lite) `show ip bgp [global|vrf <vrf-name>] summary`

Parameter	Description
global	When VRF-lite is configured, apply the command to the global routing and forwarding table.
vrf	Apply the command to the specified VRF instance.
<vrf-name>	The name of the VRF instance.

Mode User Exec and Privileged Exec

Examples
`awplus# show ip bgp summary`
`awplus# show ip bgp vrf red summary`

Output Figure 29-16: Example output from the **show ip bgp summary** command

```
awplus>show ip bgp summary

BGP router identifier 1.0.0.1, local AS number 65541
BGP table version is 12
4 BGP AS-PATH entries
0 BGP community entries

Neighbor      V      AS      MsgRc  MsgSnt  TblVer  InOutQ  Up/Down      State/PfxRcd
192.168.3.2   4      65544   20     24     11 0/0    00:07:19     1
192.168.4.2   4      65545    0      0      0 0/0    never         Active
192.168.11.2  4      65542   34     40      0 0/0    00:00:04     Active
192.168.21.2  4      65543   29     32     11 0/0    00:07:03     13

Number of neighbors 4
```

The Up/Down column in this output is a timer that shows:

- "never" if the peer session has never been established
- The up time, if the peer session is currently up
- The down time, if the peer session is currently down.

In the example above, the session with 192.168.11.2 has been down for 4 seconds, and the session with 192.168.4.2 has never been established.

Related commands [show bgp ipv6 summary \(BGP4+ only\)](#)

Command changes

- Added to AlliedWare Plus prior to 5.4.6-1
- Version 5.4.6-2.1: VRF-lite support added to BGP for AR-series products
- Version 5.4.7-2.1: BGP support added for IEx510, x550 series
- Version 5.4.7-2.4: BGP support added for IE300 series

show ip community-list

Overview Use this command to display routes that match a specified community-list name or number.

For information on filtering and saving command output, see the [“Getting Started with AlliedWare Plus” Feature Overview and Configuration Guide](#).

Syntax `show ip community-list [<listnumber>|<listname>]`

Parameter	Description
<code><listnumber></code>	Specifies the community list number in the range <1-199> as specified by a previously issued ip community-list command.
<code><listname></code>	Specifies the community list name as specified by a previously issued ip community-list command.

Mode User Exec and Privileged Exec

Examples
`awplus# show ip community-list mylist`
`awplus# show ip community-list 99`

Related commands
[ip community-list](#)
[ip community-list expanded](#)
[ip community-list standard](#)

Command changes
Added to AlliedWare Plus prior to 5.4.6-1
Version 5.4.7-2.1: BGP support added for IEx510, x550 series
Version 5.4.7-2.4: BGP support added for IE300 series

show ip extcommunity-list

Overview Use this command to display a configured extcommunity-list.
For information on filtering and saving command output, see the [“Getting Started with AlliedWare Plus” Feature Overview and Configuration Guide](#).

Syntax `show ip extcommunity-list [<1-199>|<extcommunity-listname>]`

Parameter	Description
<1-199>	Extcommunity-list number
<extcommunity-listname>	Extcommunity-list name

Mode User Exec and Privileged Exec

Example `awplus# show ip extcommunity-list 33`

Related commands [ip extcommunity-list expanded](#)
[ip extcommunity-list standard](#)

Command changes Added to AlliedWare Plus prior to 5.4.6-1
Version 5.4.7-2.1: BGP support added for IEx510, x550 series
Version 5.4.7-2.4: BGP support added for IE300 series

show ip prefix-list

Overview Use this command to display the IPv4 prefix-list entries.
Note that this command is valid for RIP and BGP routing protocols only.

Syntax `show ip prefix-list [<name>|detail|summary]`

Parameter	Description
<name>	Specify the name of a prefix list in this placeholder.
detail	Specify this parameter to show detailed output for all IPv4 prefix lists.
summary	Specify this parameter to show summary output for all IPv4 prefix lists.

Mode User Exec and Privileged Exec

Example

```
awplus# show ip prefix-list
awplus# show ip prefix-list 10.10.0.98/8
awplus# show ip prefix-list detail
```

Related commands [ip prefix-list](#)

show ipv6 prefix-list

Overview Use this command to display the prefix-list entries.

Note that this command is valid for RIPng and BGP4+ routing protocols only.

Syntax `show ipv6 prefix-list [<name>|detail|summary]`

Parameter	Description
<name>	Specify the name of an individual IPv6 prefix list.
detail	Specify this parameter to show detailed output for all IPv6 prefix lists.
summary	Specify this parameter to show summary output for all IPv6 prefix lists.

Mode User Exec and Privileged Exec

Example

```
awplus# show ipv6 prefix-list
awplus# show ipv6 prefix-list 10.10.0.98/8
awplus# show ipv6 prefix-list detail
```

Related commands [ipv6 prefix-list](#)

show ip protocols bgp (BGP only)

Overview Use this command to display BGP process parameters and statistics.
For information on filtering and saving command output, see the [“Getting Started with AlliedWare Plus” Feature Overview and Configuration Guide](#).

Syntax `show ip protocols bgp`

Mode User Exec and Privileged Exec

Example To display BGP process parameters and statistics, use the command:

```
awplus# show ip protocols bgp
```

Output Figure 29-17: Example output from the **show ip protocols bgp** command

```
Routing Protocol is "bgp 100"
IGP synchronization is disabled
Automatic route summarization is disabled
Default local-preference applied to incoming route is 100
Redistributing:
Neighbor(s):
Address AddressFamily FiltIn FiltOut DistIn DistOut RouteMapIn RouteMapOut
Weight
10.10.10.1                unicast
```

Command changes Added to AlliedWare Plus prior to 5.4.6-1
Version 5.4.7-2.1: BGP support added for IEx510, x550 series
Version 5.4.7-2.4: BGP support added for IE300 series

show route-map

Overview Use this command to display information about one or all route maps.

Syntax `show route-map <map-name>`

Parameter	Description
<code><map-name></code>	A name to identify the route map.

Mode User Exec and Privileged Exec

Example To display information about the route-map named `example-map`, use the command:

```
awplus# show route-map example-map
```

Output Figure 29-18: Example output from the **show route-map** command

```
route-map example-map, permit, sequence 1
  Match clauses:
    ip address prefix-list example-pref
  Set clauses:
    metric 100
route-map example-map, permit, sequence 200
  Match clauses:
  Set clauses:
```

Related commands [route-map](#)

synchronization

Overview Use this command in Router Configuration mode or in Address Family Configuration mode to ensure BGP does not advertise router learned from iBGP peers until they are learned locally, or are propagated throughout the AS via an IGP.

Use the **no** variant of this command to disable this function.

Syntax `synchronization`
`no synchronization`

Default Disabled.

Mode Router Configuration and Address Family Configuration mode

Usage notes Synchronization is used when a BGP router should not advertise routes learned from iBGP neighbors, unless those routes are also present in an IGP (for example, OSPF). These routes must be in the RIB (Routing Information Base) learned locally or via an IGP.

Synchronization may be enabled when all the routers in an autonomous system do not speak BGP, and the autonomous system is a transit for other autonomous systems.

Use the **no synchronization** command when BGP router can advertise routes learned from iBGP neighbors, without waiting for IGP reachability, when routes are in the RIB.

Example The following example enables IGP synchronization of iBGP routes in Router Configuration mode:

```
awplus# configure terminal
awplus(config)# router bgp 11
awplus(config-router)# synchronization
```

The following example enables IGP synchronization of iBGP routes in IPv4 unicast Address Family Configuration mode:

```
awplus# configure terminal
awplus(config)# router bgp 11
awplus(config)# address-family ipv4 unicast
awplus(config-af)# synchronization
```

The following example enables IGP synchronization of iBGP routes in the IPv6 unicast Address Family Configuration mode:

```
awplus# configure terminal
awplus(config)# router bgp 11
awplus(config)# address-family ipv6 unicast
awplus(config-af)# synchronization
```

Command changes Added to AlliedWare Plus prior to 5.4.6-1
Version 5.4.7-2.1: BGP support added for IEx510, x550 series
Version 5.4.7-2.4: BGP support added for IE300 series

timers (BGP)

Overview Use this command sets the BGP keepalive timer and holdtime timer values.
Use the **no** variant of this command to reset timers to the default.

Syntax `timers bgp <keepalive> <holdtime>`
`no timers bgp [<keepalive> <holdtime>]`

Parameter	Description
<code><keepalive></code>	<code><0-65535></code> The frequency with which the keepalive messages are sent to the neighbors. The default is 30 seconds as per RFC 4271. Cisco IOS uses a 60 second keepalive timer default value. Adjust keepalive timers for interoperability as required. Maintain the keepalive value at the holdtime value / 3.
<code><holdtime></code>	<code><0-65535></code> The interval after which the neighbor is considered dead if keepalive messages are not received. The default holdtime value is 90 seconds as per RFC 4271. Cisco IOS uses a 180 second holdtime timer default value. Adjust holdtime timers for interoperability as required. Maintain the holdtime value at the keepalive value * 3.

Default The keepalive timer default is 60 seconds, the holdtime timer default is 90 seconds, and the connect timer default is 120 seconds as per RFC 4271. Holdtime is keepalive * 3.

Mode Router Configuration

Usage notes This command is used globally to set or unset the keepalive and holdtime values for all the neighbors.

Examples

```
awplus# configure terminal
awplus(config)# router bgp 10
awplus(config-router)# timers bgp 40 120
awplus# configure terminal
awplus(config)# router bgp 10
awplus(config-router)# no timers bgp 30 90
awplus# configure terminal
awplus(config)# router bgp 10
awplus(config-router)# no timers bgp
```

Related commands

- [neighbor timers](#)
- [show ip bgp neighbors hold-time \(BGP only\)](#)
- [show ip bgp neighbors keepalive-interval \(BGP only\)](#)

- Command changes**
- Added to AlliedWare Plus prior to 5.4.6-1
 - Version 5.4.7-2.1: BGP support added for IEx510, x550 series
 - Version 5.4.7-2.4: BGP support added for IE300 series

undebug bgp (BGP only)

Overview Use this command to disable BGP debugging functions.

Syntax undebug bgp
[all|dampening|events|filters|fsm|keepalives|nht|nsm|updates]
undebug all bgp

Parameter	Description
all	Disable all debugging for BGP.
dampening	Disable debugging for BGP dampening.
events	Disable debugging for BGP events.
filters	Disable debugging for BGP filters.
fsm	Disable debugging for BGP Finite State Machine (FSM).
keepalives	Disable debugging for BGP keepalives.
nht	Disable debugging for BGP NHT (Next Hop Tracking) messages.
nsm	Disable debugging for NSM messages.
updates	Disable debugging for BGP updates.

Mode Privileged Exec and Global Configuration

Example awplus# undebug bgp events
awplus# undebug bgp nht
awplus# undebug bgp updates

Related commands [debug bgp \(BGP only\)](#)

Command changes Added to AlliedWare Plus prior to 5.4.6-1
Version 5.4.7-2.1: BGP support added for IEx510, x550 series
Version 5.4.7-2.4: BGP support added for IE300 series

30

Route Map Commands

Introduction

Overview This chapter provides an alphabetical reference for route map commands. For more information, see the [Routemaps Feature Overview and Configuration Guide](#). These commands can be divided into the following categories:

- the [route-map](#) command, which is used to create a route map and/or route map entry, and to put you into route map mode
- **match** commands, used to determine which routes or BGP update messages the route map applies to
- **set** commands, used to modify matching routes or BGP update messages

- Command List**
- ["match as-path"](#) on page 1529
 - ["match community"](#) on page 1530
 - ["match interface"](#) on page 1532
 - ["match ip address"](#) on page 1533
 - ["match ip next-hop"](#) on page 1535
 - ["match ipv6 address"](#) on page 1537
 - ["match ipv6 next-hop"](#) on page 1539
 - ["match metric"](#) on page 1540
 - ["match origin"](#) on page 1541
 - ["match route-type"](#) on page 1543
 - ["match tag"](#) on page 1544
 - ["route-map"](#) on page 1545
 - ["set aggregator"](#) on page 1548
 - ["set as-path"](#) on page 1549
 - ["set atomic-aggregate"](#) on page 1550

- [“set comm-list delete”](#) on page 1551
- [“set community”](#) on page 1552
- [“set dampening”](#) on page 1554
- [“set extcommunity”](#) on page 1556
- [“set ip next-hop \(route map\)”](#) on page 1558
- [“set ipv6 next-hop”](#) on page 1559
- [“set local-preference”](#) on page 1560
- [“set metric”](#) on page 1561
- [“set metric-type”](#) on page 1563
- [“set origin”](#) on page 1564
- [“set originator-id”](#) on page 1565
- [“set tag”](#) on page 1566
- [“set weight”](#) on page 1567
- [“show route-map”](#) on page 1568

match as-path

Overview Use this command to add an autonomous system (AS) path match clause to a route map entry. Specify the AS path attribute value or values to match by specifying the name of an AS path access list.

A BGP update message matches the route map if its attributes include AS path values that match the AS path access list.

Each entry of a route map can only match against one AS path access list in one AS path match clause. If the route map entry already has an AS path match clause, entering this command replaces that match clause with the new clause.

Note that AS path access lists and route map entries both specify an action of deny or permit. The action in the AS path access list determines whether the route map checks update messages for a given AS path value. The route map action and its **set** clauses determine what the route map does with update messages that contain that AS path value.

Use the **no** variant of this command to remove the AS path match clause from a route map entry.

Syntax `match as-path <as-path-listname>`
`no match as-path [<as-path-listname>]`

Parameter	Description
<code><as-path-listname></code>	Specifies an AS path access list name.

Mode Route-map Configuration

Usage notes This command is valid for BGP update messages only.

Example To add entry 34 to the route map called `myroute`, which will discard update messages if they contain the AS path values that are included in `myaccesslist`, use the commands:

```
awplus# configure terminal
awplus(config)# route-map myroute deny 34
awplus(config-route-map)# match as-path myaccesslist
```

Related commands [route-map](#)
[set as-path](#)
[show route-map](#)

Command changes Added to AlliedWare Plus prior to 5.4.6-1
Version 5.4.7-2.1: BGP support added for IEx510, x550 series
Version 5.4.7-2.4: BGP support added for IE300 series

match community

Overview Use this command to add a community match clause to a route map entry. Specify the community value or values to match by specifying a community list. To create the community list, enter Global Configuration mode and use the [ip community-list](#) command.

A BGP update message matches the route map if its attributes include community values that match the community list.

Each entry of a route map can only match against one community list in one community match clause. If the route map entry already has a community match clause, entering this command replaces that match clause with the new clause.

Note that community lists and route map entries both specify an action of deny or permit. The action in the community list determines whether the route map checks update messages for a given community value. The route map action and its **set** clauses determine what the route map does with update messages that contain that community value.

Use the **no** variant of this command to remove the community match clause from a route map.

Syntax

```
match community  
{<community-listname>|<1-99>|<100-199>} [exact-match]  
  
no match community  
[<community-listname>|<1-99>|<100-199>|exact-match]
```

Parameter	Description
<community-listname>	The community list name or number.
<1-99>	Community list number (standard range).
<100-199>	Community list number (expanded range).
exact-match	Exact matching of communities.

Mode Route-map Configuration

Usage notes This command is valid for BGP update messages only.

Communities are used to group and filter routes. They are designed to provide the ability to apply policies to large numbers of routes by using match and set commands. Community lists are used to identify and filter routes by their common attributes.

Example To add entry 3 to the route map called `myroute`, which will process update messages if they contain the community values that are included in `mylist`, use the commands:

```
awplus# configure terminal
awplus(config)# route-map myroute permit 3
awplus(config-route-map)# match community mylist
```

Related commands

- `ip community-list`
- `route-map`
- `set comm-list delete`
- `set community`
- `show route-map`

Command changes

- Added to AlliedWare Plus prior to 5.4.6-1
- Version 5.4.7-2.1: BGP support added for IEx510, x550 series
- Version 5.4.7-2.4: BGP support added for IE300 series

match interface

Overview Use this command to add an interface match clause to a route map entry. Specify the interface name to match.

A route matches the route map if its interface matches the interface name.

Each entry of a route map can only match against one interface in one interface match clause. If the route map entry already has an interface match clause, entering this command replaces that match clause with the new clause.

Use the **no** variant of this command to remove the interface match clause from the route map entry. Use the **no** variant of this command without a specified interface to remove all interfaces.

Syntax `match interface <interface>`
`no match interface [<interface>]`

Parameter	Description
<interface>	The interface to match.

Mode Route-map Configuration

Usage This command is valid for RIP and OSPF routes only.

Example To add entry 10 to the route map called 'mymap1', which will process routes if they use the interface eth1, use the commands:

```
awplus# configure terminal
awplus(config)# route-map mymap1 permit 10
awplus(config-route-map)# match interface eth1
```

To remove all interfaces from the route map called 'mymap1', use the commands:

```
awplus# configure terminal
awplus(config)# route-map mymap1 permit 10
awplus(config-route-map)# no match interface
```

Related commands

- [match ip address](#)
- [match ip next-hop](#)
- [match route-type](#)
- [match tag](#)
- [route-map](#)
- [show route-map](#)

match ip address

Overview Use this command to add an IP address prefix match clause to a route map entry. You can specify the prefix or prefixes to match by specifying the name of the prefix list. To create the prefix list, enter Global Configuration mode and use the **ip prefix-list** command.

A route matches the route map entry if the route's prefix matches the prefix list.

Use the **no** variant of this command to remove the IP address match clause from a route map entry.

Syntax `match ip address prefix-list <prefix-listname>`
`no match ip address prefix-list <prefix-listname>`

Parameter	Description
prefix-list	Use an IP prefix list to specify which prefixes to match.
	<code><prefix-listname></code> The prefix list name.

Mode Route-map Configuration

Usage notes Each entry of a route map can have at most one prefix list-based IP address match clause. If the route map entry already has one match clause, entering this command replaces that match clause with the new clause.

Note that prefix lists and route map entries both specify an action of deny or permit. The action in the prefix list determines whether the route map checks update messages and routes for a given prefix. The action in the route map, and the map's **set** clauses, determine what the device does with update messages or routes that contain that prefix.

If the **match ip address** command results in a match against the specified IP address, then the outcome is:

- If **permit** is specified, then the route is redistributed or controlled, as specified by the set action.
- If **deny** is specified, then the route is not redistributed or controlled.

If the match criteria are not met, the route is neither accepted nor forwarded, irrespective of **permit** or **deny** specifications.

This command is valid for:

- OSPF routes
- routes in BGP update messages
- RIP routes.

Examples To add entry 3 to the route map called 'rmap1', which will process routes that match the prefix list called 'mylist', use the commands:

```
awplus# configure terminal
awplus(config)# route-map rmap1 permit 3
awplus(config-route-map)# match ip address prefix-list mylist
```

Related commands [route-map](#)
[show route-map](#)

match ip next-hop

Overview Use this command to add a next-hop match clause to a route map entry. You can specify the next hop to match by specifying the name of a prefix list. To create the prefix list, enter Global Configuration mode and use the **ip prefix-list** command.

A route matches the route map if the route's next hop matches the prefix list.

Each entry of a route map can have at most one prefix list-based next-hop match clause. If the route map entry already has one match clause, entering this command replaces that match clause with the new clause.

Note that the lists and route map entries specify an action of deny or permit. The action in the list determines whether the route map checks update messages and routes for a given next-hop value. The route map action and its **set** clauses determine what the route map does with update messages and routes that contain that next hop.

Use the **no** variant of this command to remove the next-hop match clause from a route map entry. To remove a prefix list-based match clause you must also specify the prefix-list parameter.

Syntax `match ip next-hop prefix-list <prefix-listname>`
`no match ip next-hop prefix-list [<prefix-listname>]`

Parameter	Description
prefix-list	Use an IP prefix list to specify which next hops to match.
	<code><prefix-listname></code> The prefix list name.

Mode Route-map Configuration

Usage notes This command is valid for:

- OSPF routes
- routes in BGP update messages
- RIP routes.

Examples To add entry 3 to the route map called 'mymap', which will process routes whose next hop matches the prefix list called 'list1', use the commands:

```
awplus# configure terminal
awplus(config)# route-map mymap permit 3
awplus(config-route-map)# match ip next-hop prefix-list list1
```

**Related
commands**

- ip prefix-list
- route-map
- show ip prefix-list
- show route-map

match ipv6 address

Overview Use this command to add an IPv6 address prefix match clause to a route map entry. You can specify the prefix or prefixes to match by specifying the name of the prefix list. To create the prefix list, enter Global Configuration mode and use the **ipv6 prefix-list** command.

A route matches the route map entry if the route's prefix matches the prefix list.

Use the **no** variant of this command to remove the IPv6 address match clause from a route map entry.

Syntax

```
match ipv6 address prefix-list <prefix-listname>
no match ipv6 address
no match ipv6 address prefix-list <prefix-listname>
```

Parameter	Description
prefix-list	Use an IP prefix list to specify which prefixes to match.
<prefix-listname>	The prefix list name.

Mode Route-map Configuration

Usage notes Each entry of a route map can have at most one prefix list-based IPv6 address match clause. If the route map entry already has one match clause, entering this command replaces that match clause with the new clause.

Note that prefix lists and route map entries all specify an action of deny or permit. The action in the prefix list determines whether the route map checks update messages and routes for a given prefix. The action in the route map, and the map's **set** clauses, determine what the device does with update messages or routes that contain that prefix.

If the **match ipv6 address** command results in a match against the specified IPv6 address, then the outcome is:

- If **permit** is specified, then the route is redistributed or controlled, as specified by the set action.
- If **deny** is specified, then the route is not redistributed or controlled.

If the match criteria are not met, the route is neither accepted nor forwarded, irrespective of **permit** or **deny** specifications.

This command is valid for:

- OSPF routes
- routes in BGP update messages
- RIP routes.

Examples To match traffic according to the prefix list named "mylist", use the commands:

```
awplus# configure terminal
awplus(config)# route-map rmap1 permit 3
awplus(config-route-map)# match ipv6 address prefix-list mylist
```

match ipv6 next-hop

Overview Use this command to specify a next-hop address to be matched by the route-map. Use the **no** variant of this command to disable this function.

Syntax

```
match ipv6 next-hop <ipv6-addr>
match ipv6 next-hop prefix-list <prefix-listname>
match ipv6 next-hop [<ipv6-addr>]
match ipv6 next-hop [prefix-list <prefix-listname>]
```

Parameter	Description
<ipv6-addr>	The IPv6 address of the next hop. The IPv6 address uses the format X:X::X:X.
<prefix-listname>	The name of the IPv6 prefix list that specifies criteria for the addresses to be matched.

Mode Route-map Configuration

Usage notes The **match ipv6 next-hop** command specifies the next-hop address to be matched. If there is a match for the specified next-hop address, and permit is specified, the route is redistributed or controlled as specified by the set action. If the match criteria are met, and deny is specified, the route is not redistributed or controlled. If the match criteria are not met, the route is neither accepted nor forwarded, irrespective of permit or deny specifications.

NOTE: This command is valid only for BGP.

Example

```
awplus# configure terminal
awplus(config)# route-map rmap1 permit 3
awplus(config-route-map)# match ipv6 next-hop 2001:0db8::/32
```

match metric

Overview Use this command to add a metric match clause to a route map entry. Specify the metric value to match.

A route matches the route map if its metric matches the route map's metric.

A BGP update message matches the route map if its MED attribute value matches the route map's metric.

Each entry of a route map can only match against one metric value in one metric match clause. If the route map entry already has a metric match clause, entering this command replaces that match clause with the new clause.

Use the **no** variant of this command to remove the metric match clause from the route map entry.

Syntax `match metric <metric>`
`no match metric [<metric>]`

Parameter	Description
<metric>	<0-4294967295> Specifies the metric value.

Mode Route-map Configuration

Usage notes This command is valid for:

- OSPF routes
- routes in BGP update messages
- RIP routes.

Example To stop entry 3 of the route map called "myroute" from processing routes with a metric of 888999, use the commands:

```
awplus# configure terminal
awplus(config)# route-map myroute permit 3
awplus(config-route-map)# no match metric 888999
```

Related commands [route-map](#)
[set metric](#)
[show route-map](#)

match origin

Overview Use this command to add an origin match clause to a route map entry. Specify the origin attribute value to match.

A BGP update message matches the route map if its origin attribute value matches the route map's origin value.

Each entry of a route map can only match against one origin in one origin match clause. If the route map entry already has an origin match clause, entering this command replaces that match clause with the new clause.

Use the **no** variant of this command to remove the origin match clause from the route map entry.

Syntax `match origin {egp|igp|incomplete}`
`no match origin [egp|igp|incomplete]`

Parameter	Description
egp	Learned from an exterior gateway protocol.
igp	Learned from a local interior gateway protocol.
incomplete	Of unknown heritage, for example a static route.

Mode Route-map Configuration

Usage The origin attribute defines the origin of the path information. The **egp** parameter is indicated as an **e** in the routing table, and it indicates that the origin of the information is learned via Exterior Gateway Protocol. The **igp** parameter is indicated as an **i** in the routing table, and it indicates the origin of the path information is interior to the originating AS. The **incomplete** parameter is indicated as a **?** in the routing table, and indicates that the origin of the path information is unknown or learned through other means. If a static route is redistributed into BGP, the origin of the route is incomplete.

The **match origin** command specifies the origin to be matched. If there is a match for the specified origin, and **permit** is specified, the route is redistributed or controlled as specified by the set action. If the match criteria are met, and **deny** is specified, the route is not redistributed or controlled. If the match criteria are not met, the route is neither accepted nor forwarded, irrespective of **permit** or **deny** specifications.

This command is valid for BGP update messages only.

Example To add entry 34 to the route map called "rmap1", which will drop externally-originated routes, use the commands:

```
awplus# configure terminal
awplus(config)# route-map myroute deny 34
awplus(config-route-map)# match origin egp
```

**Related
commands** route-map
set origin
show route-map

match route-type

Overview Use this command to add an external route-type match clause to a route map entry. Specify whether to match OSPF type-1 external routes or OSPF type-2 external routes.

An OSPF route matches the route map if its route type matches the route map's route type.

Each entry of a route map can only match against one route type in one match clause. If the route map entry already has a route type match clause, entering this command replaces that match clause with the new clause.

Use the **no** variant of this command to remove the route type match clause from the route map entry.

Syntax `match route-type external {type-1|type-2}`
`no match route-type external [type-1|type-2]`

Parameter	Description
type-1	OSPF type-1 external routes.
type-2	OSPF type-2 external routes.

Mode Route-map Configuration

Usage Use the **match route-type external** command to match specific external route types. AS- external LSA is either Type-1 or Type-2. **external type-1** matches only Type 1 external routes, and **external type-2** matches only Type 2 external routes. This command is valid for OSPF routes only.

Example To add entry 10 to the route map called `mymap1`, which will process type-1 external routes, use the commands:

```
awplus# configure terminal
awplus(config)# route-map mymap1 permit 10
awplus(config-route-map)# match route-type external type-1
```

Related commands

- [match interface](#)
- [match ip address](#)
- [match ip next-hop](#)
- [match tag](#)
- [route-map](#)
- [set metric-type](#)
- [show route-map](#)

match tag

Overview Use this command to add a tag match clause to a route map entry. Specify the route tag value to match.

An OSPF route matches the route map if it has been tagged with the route map's tag value. Routes can be tagged through OSPF commands or through another route map's set clause.

Each entry of a route map can only match against one tag in one match clause. If the route map entry already has a tag match clause, entering this command replaces that match clause with the new clause.

Use the **no** variant of this command to remove the tag match clause from the route map entry.

Syntax `match tag <0-4294967295>`
`no match tag [<0-4294967295>]`

Mode Route-map Configuration

Usage This command is valid for OSPF routes only.

Example To add entry 10 to the route map called `mymap1`, which will process routes that are tagged 100, use the following commands:

```
awplus# configure terminal
awplus(config)# route-map mymap1 permit 10
awplus(config-route-map)# match tag 100
```

Related commands

- [match interface](#)
- [match ip address](#)
- [match ip next-hop](#)
- [match route-type](#)
- [route-map](#)
- [set tag](#)
- [show route-map](#)

route-map

Overview Use this command to configure a route map entry, and to specify whether the device will process or discard matching routes and BGP update messages.

The device uses a name to identify the route map, and a sequence number to identify each entry in the route map.

The **route-map** command puts you into route-map configuration mode. In this mode, you can use the following:

- one or more of the **match** commands to create match clauses. These specify what routes or update messages match the entry.
- one or more of the **set** commands to create set clauses. These change the attributes of matching routes or update messages.

Use the **no** variant of this command to delete a route map or to delete an entry from a route map.

Syntax

```
route-map <mapname> {deny|permit} <seq>  
no route-map <mapname>  
no route-map <mapname> {deny|permit} <seq>
```

Parameter	Description
<mapname>	A name to identify the route map.
deny	The route map causes a routing process to discard matching routes or BGP update messages.
permit	The route map causes a routing process to use matching routes or BGP update messages.
<seq>	<1-65535> The sequence number of the entry. You can use this parameter to control the order of entries in this route map.

Mode Global Configuration

Usage notes Route maps allow you to control and modify routing information by filtering routes and setting route attributes. You can apply route maps when the device:

- processes BGP update messages that it has received from a peer
- prepares BGP update messages to send to peers
- redistributes routes from one routing protocol into another
- redistributes static routes into routing protocols
- uses BGP route flap dampening

When a routing protocol passes a route or update message through a route map, it checks the entries in order of their sequence numbers, starting with the lowest numbered entry.

If it finds a match on a route map with an action of permit, then it applies any set clauses and accepts the route. Having found a match, the route is not compared against any further entries of the route map.

If it finds a match on a route map with an action of deny, it will discard the matching route.

If it does not find a match, it discards the route or update message. This means that route maps end with an implicit deny entry. To permit all non-matching routes or update messages, end your route map with an entry that has an action of **permit** and no match clause.

Examples To enter route-map mode for entry 1 of the route map called "route1", and then add a match and set clause to it, use the commands:

```
awplus# configure terminal
awplus(config)# route-map route1 permit 1
awplus(config-route-map)# match as-path 60
awplus(config-route-map)# set weight 70
```

To enter route-map mode for entry 2 of the route map called "route1", and then add a match and set clause to it, use the commands:

```
awplus# configure terminal
awplus(config)# route-map route1 permit 2
awplus(config-route-map)# match interface eth1
awplus(config-route-map)# set metric 20
```

Note how the prompt changes when you go into route map configuration mode.

To make the device process non-matching routes instead of discarding them, add a command like the following one:

```
awplus(config)# route-map route1 permit 100
```

Related commands

For BGP:

- show route-map
- bgp dampening
- neighbor default-originate
- neighbor route-map
- neighbor unsuppress-map
- network (BGP and BGP4+)
- redistribute (into BGP or BGP4+)
- show ip bgp route-map (BGP only)

For OSPF:

- default-information originate
- redistribute (OSPF)

For RIP:

`redistribute (RIP)`

set aggregator

Overview Use this command to add an aggregator set clause to a route map entry.

When a BGP update message matches the route map entry, the device sets the update's aggregator attribute. The aggregator attribute specifies the AS and IP address of the device that performed the aggregation.

Use the **no** variant of this command to remove the set clause.

Syntax `set aggregator as <asnum> <ip-address>`
`no set aggregator as`

Parameter	Description
<asnum>	The AS number of the aggregator.
<ip-address>	The IP address of the aggregator.

Mode Route-map Configuration

Usage An Autonomous System (AS) is a collection of networks under a common administration sharing a common routing strategy. It is subdivided by areas, and is assigned a unique 16-bit number. Use the **set aggregator** command to assign an AS number for the aggregator.

This command is valid for BGP update messages only.

Example To use entry 3 of the route map called `myroute` to set the aggregator attribute to 43 10.10.0.3 in matching update messages, use the commands:

```
awplus# configure terminal
awplus(config)# route-map myroute permit 3
awplus(config-route-map)# set aggregator as 43 10.10.0.3
```

To remove all aggregator attributes for entry 3 of the route map called `myroute`, use the commands:

```
awplus# configure terminal
awplus(config)# route-map myroute permit 3
awplus(config-route-map)# no set aggregator as
```

Related commands [route-map](#)
[show route-map](#)

set as-path

Overview Use this command to add an AS path set clause to a route map entry.

When a BGP update message matches the route map entry, the device prepends the specified Autonomous System Number (ASN) or ASNs to the update's AS path attribute.

The AS path attribute is a list of the autonomous systems through which the announcement for the prefix has passed. As prefixes pass between autonomous systems, each autonomous system adds its ASN to the beginning of the list. This means that the AS path attribute can be used to make routing decisions.

Use the **no** variant of this command to remove the set clause.

Syntax `set as-path prepend <1-65535> [<1-65535>]...`
`no set as-path prepend [<1-65535> [<1-65535>]...]`

Parameter	Description
<code>prepend</code>	Prepends the autonomous system path.
<code><1-65535></code>	The number to prepend to the AS path. If you specify multiple ASNs, separate them with spaces.

Mode Route-map mode

Usage notes Use the **set as-path** command to specify an autonomous system path. By specifying the length of the AS-Path, the device influences the best path selection by a neighbor. Use the `prepend` parameter with this command to prepend an AS path string to routes increasing the AS path length.

This command is valid for BGP update messages only.

Example To use entry 3 of the route map called `myroute` to prepend ASN 8 and 24 to the AS path of matching update messages, use the commands:

```
awplus# configure terminal
awplus(config)# route-map myroute permit 3
awplus(config-route-map)# set as-path prepend 8 24
```

Related commands [match as-path](#)
[route-map](#)
[show route-map](#)

Command changes Added to AlliedWare Plus prior to 5.4.6-1
Version 5.4.7-2.1: BGP support added for IEx510, x550 series
Version 5.4.7-2.4: BGP support added for IE300 series

set atomic-aggregate

Overview Use this command to add an atomic aggregate set clause to a route map entry. When a BGP update message matches the route map entry, the device adds the atomic aggregate attribute to the update. Use the **no** variant of this command to remove the set clause.

Syntax `set atomic-aggregate`
`no set atomic-aggregate`

Mode Route-map Configuration

Usage This command is valid for BGP update messages only.

Example To use entry 3 of the route map called `rmap1` to add the atomic aggregator attribute to matching update messages, use the commands:

```
awplus# configure terminal
awplus(config)# route-map rmap1 permit 3
awplus(config-route-map)# set atomic-aggregate
```

Related commands [route-map](#)
[show route-map](#)

set comm-list delete

Overview Use this command to delete one or more communities from the community attribute of a BGP update message. Specify the communities to delete by specifying a community list. To create the community list, enter Global Configuration mode and use the [ip community-list](#) command.

When a BGP update message matches the route map entry, the device deletes the specified communities from the update's community attribute.

Use the **no** variant of this command to stop deleting the communities.

Syntax

```
set comm-list {<1-199>|<100-199>|<word>} delete  
no set comm-list {<1-199>|<100-199>|<word>} delete
```

Parameter	Description
<1-99>	Standard community-list number.
<100-199>	Expanded community-list number.
<word>	Name of the Community-list.

Mode Route-map Configuration

Usage This command is valid for BGP update messages only.

Example To use entry 3 of the route map called `myroute` to delete the communities in community list 34 from matching update messages, use the commands:

```
awplus# configure terminal  
awplus(config)# route-map myroute permit 3  
awplus(config-route-map)# set comm-list 34 delete
```

Related commands

- [ip community-list](#)
- [match community](#)
- [route-map](#)
- [set community](#)
- [show route-map](#)

set community

Overview Use this command to add a community set clause to a route map entry.

When a BGP update message matches the route map entry, the device takes one of the following actions:

- changes the update's community attribute to the specified value or values, or
- adds the specified community value or values to the update's community attribute, if you specify the **additive** parameter after specifying another parameter. or
- removes the community attribute from the update, if you specify the **none** parameter

Use the **no** variant of this command to remove the set clause.

Syntax

```
set community {[<1-65535>][AA:NN] [internet] [local-AS]
[no-advertise] [no-export] [additive]}
no set community {[AA:NN] [internet] [local-AS] [no-advertise]
[no-export] [additive]}
set community none
no set community none
```

Parameter	Description
<1-65535>	The AS number of the community as an integer not in AA:NN format.
AA:NN	The Autonomous System (AS) number of the community, in AA:NN format. AS numbers are assigned to the regional registries by the IANA (www.iana.org) and can be obtained from the registry in your region. AA and NN are both integers from 1 to 65535. AA is the AS number; NN is a value chosen by the ASN administrator.
local-AS	The community of routes that must not be advertised to external BGP peers (this includes peers in other members' Autonomous Systems inside a BGP confederation).
internet	The community of routes that can be advertised to all BGP peers.
no-advertise	The community of routes that must not be advertised to other BGP peers.
no-export	The community of routes that must not be advertised outside a BGP confederation boundary (a standalone Autonomous System that is not part of a confederation should be considered a confederation itself).

Parameter	Description
none	The device removes the community attribute from matching update messages.
additive	The device adds the specified community value to the update message's community attribute, instead of replacing the existing attribute. By default this parameter is not included, so the device replaces the existing attribute.

Mode Route-map Configuration

Usage notes This command is valid for BGP update messages only.

Examples To use entry 3 of the route map called `rmap1` to put matching routes into the no-advertise community, use the commands:

```
awplus# configure terminal
awplus(config)# route-map rmap1 permit 3
awplus(config-route-map)# set community no-advertise
```

To use entry 3 of the route map called `rmap1` to put matching routes into several communities, use the commands:

```
awplus# configure terminal
awplus(config)# route-map rmap1 permit 3
awplus(config-route-map)# set community 10:01 23:34 12:14
no-export
```

To use entry 3 of the route map called `rmap1` to put matching routes into a single AS community numbered 16384, use the commands:

```
awplus# configure terminal
awplus(config)# route-map rmap1 permit 3
awplus(config-route-map)# set community 16384 no-export
```

Related commands [match community](#)
[route-map](#)

[set aggregator](#)
[set comm-list delete](#)
[set extcommunity](#)
[show route-map](#)

Command changes Added to AlliedWare Plus prior to 5.4.6-1
Version 5.4.7-2.1: BGP support added for IEx510, x550 series
Version 5.4.7-2.4: BGP support added for IE300 series

set dampening

Overview Use this command to add a route flap dampening set clause to a route map entry.

Also use the route map by specifying it in the command [bgp dampening route-map](#).

When a route matches the route map entry, the device enables route flap dampening for that route. If the set clause includes dampening parameter values, the device uses those values when dampening the matching route.

Use the **no** variant of this command to remove the set clause. This disables dampening on matching routes.

Syntax

```
set dampening
set dampening [<reachtime>]
set dampening <reachtime> [<reuse> <suppress> <maxsuppress>]
[<unreachtime>]
no set dampening
no set dampening [<reachtime>]
no set dampening <reachtime> [<reuse> <suppress> <maxsuppress>]
[<unreachtime>]
```

Parameter	Description
<reachtime>	<1-45> The time it takes, in minutes, for the route's instability penalty to halve if the route remains stable. The instability penalty is called the Figure of Merit (FoM). For example, if reachtime is 15, the FoM of a stable route halves over a 15 minute period, quarters over a 30 minute period, and so on. The default is 15 minutes.
<reuse>	<1-20000> The value that the instability penalty (FoM) must reach for the device to use a suppressed route again. Once a route is suppressed, it remains suppressed until its FoM falls below this threshold. Reuse must not exceed suppress. The default is 750.
<suppress>	<1-20000> The instability penalty (FoM) at which the route is suppressed. Suppress must be greater than or equal to reuse. If suppress is less than 1000, a route is suppressed when it becomes unreachable for the first time. The default is 2000.

Parameter	Description
<code><maxsuppress></code>	<code><1-255></code> A number that is multiplied by reachtime to give the maximum time in minutes for which a suppressed route must remain stable in order to become unsuppressed. The lowest maxsuppress value of 1 gives a maximum suppression time of 1 x reachtime, and the highest maxsuppress value of 255 gives a maximum suppression time of 255 x reachtime. For example, if reachtime is 15 and maxsuppress is 4, the route is unsuppressed after 60 minutes of stability even if its FoM still exceeds reuse. The default is 4.
<code><unreachtime></code>	<code><1-45></code> The time it takes, in minutes, for the route's instability penalty to halve if the route remains unstable. The default is 15 minutes.

Mode Route-map Configuration

Usage The **suppress** value must be greater than or equal to the **reuse** value.
Set the unreachability half-life time to be equal to, or greater than, reachability half-life time. The suppress-limit value must be greater than or equal to the reuse limit value.

This command is valid for BGP routes only.

Example To use entry 24 of the route map called R1 to enable dampening of matching routes and set the dampening parameters, use the commands:

```
configure terminal
route-map R1 permit 24
set dampening 20 333 534 30
```

Related commands

set extcommunity

Overview Use this command to add an extended community set clause to a route map entry. A route map entry can have a route target extended community set clause, a site-of-origin extended community set clause, or both.

When a BGP update message matches the route map entry, the device sets the update's extended community attribute to the specified value or values.

Use the **no** variant of this command to remove the set clause.

Syntax `set extcommunity {rt|soo} <extcomm-number>`
`no set extcommunity {rt|soo} [<extcomm-number>]`

Parameter	Description
rt	Configure a route target extended community. This consists of routers that will receive matching routes.
soo	Configure a site-of-origin extended community. This consists of routers that will inject matching routes into BGP.
<extcomm-number>	The extended community number, in the format AA:NN or IPADD:N.

Mode Route-map Configuration

Usage notes This command is valid for BGP update messages only.

Examples To use entry 3 of the route map called `rmap1` to set the route target extended community attribute to `06:01`, use the commands:

```
awplus# configure terminal
awplus(config)# route-map rmap1 permit 3
awplus(config-route-map)# set extcommunity rt 06:01
```

To instead specify the extended community number in dotted decimal notation, use the command:

```
awplus# configure terminal
awplus(config)# route-map rmap1 permit 3
awplus(config-route-map)# set extcommunity rt 0.0.0.6:01
```

To use entry 3 of the route map called `rmap1` to set the site-of-origin extended community attribute to `06:01`, use the commands:

```
awplus# configure terminal
awplus(config)# route-map rmap1 permit 3
awplus(config-route-map)# set extcommunity soo 06:01
```

To instead specify the extended community number in dotted decimal notation, use the command:

```
awplus# configure terminal
awplus(config)# route-map rmap1 permit 3
awplus(config-route-map)# set extcommunity soo 0.0.0.6:01
```

**Related
commands**

[match community](#)
[route-map](#)
[set comm-list delete](#)
[set community](#)
[show route-map](#)

set ip next-hop (route map)

Overview Use this command to add a next-hop set clause to a route map entry.

When a route or BGP update message matches the route map entry, the device sets the route's next hop to the specified IP address.

Use the **no** variant of this command to remove the set clause.

Syntax `set ip next-hop <ip-address>`
`no set ip next-hop [<ip-address>]`

Parameter	Description
<code><ip-address></code>	The IP address of the next hop, entered in the form A.B.C.D.

Mode Route-map Configuration

Usage notes Use this command to set the next-hop IP address to the routes.

This command is valid for:

- OSPF routes
- routes in BGP update messages
- RIP routes.

Example To use entry 3 of the route map called `mymap` to give matching routes a next hop of 10.10.0.67, use the commands:

```
awplus# configure terminal
awplus(config)# route-map mymap permit 3
awplus(config-route-map)# set ip next-hop 10.10.0.67
```

Related commands [match ip next-hop](#)
[route-map](#)
[show route-map](#)

set ipv6 next-hop

Overview Use this command to set a next hop-address.

Use the **no** variant of this command to delete an entry.

Syntax `set ipv6 next-hop {<ipv6-addr-global>|local <ipv6-addr>}`
`no set ipv6 next-hop [<ipv6-addr-global>|local [<ipv6-addr>]]`

Parameter	Description
<code><ipv6-addr-global></code>	The IPv6 global address of next hop. The IPv6 address uses the format X:X::X:X.
<code>local</code>	Specifies that the address is local.
<code><ipv6-addr></code>	The IPv6 local address of next hop. The IPv6 address uses the format X:X::X:X.

Mode Route-map Configuration

Usage notes Use this command to set the next-hop IPv6 address to the routes.

This command is valid only for BGP.

Examples

```
awplus# configure terminal
awplus(config)# route-map rmap1 permit 3
awplus(config-route-map)# set ipv6 next-hop local
fe80::203:47ff:fe97:66dc
awplus(config-route-map)# no set ipv6 next-hop
```

set local-preference

Overview This command changes the default local preference value.

The local preference indicates the BGP local preference path attribute when there are multiple paths to the same destination. The path with the higher preference is chosen.

Use this command to define the preference of a particular path. The preference is sent to all routers and access servers in the local autonomous system.

The **no** variant of this command reverts to the default setting.

Syntax `set local-preference <pref-value>`
`no set local-preference [<pref-value>]`

Parameter	Description
<code><pref-value></code>	<code><0-4294967295></code> Configure local preference value. The default local preference value is 100.

Mode Route-map Configuration

Examples

```
awplus# configure terminal
awplus(config)# route-map rmap1 permit 3
awplus(config-route-map)# set local-preference 2345555
awplus# configure terminal
awplus(config)# router bgp 100
awplus(config-route-map)# no set local-preference
```

Related commands For related Route Map commands:

[route-map](#)

[show route-map](#)

For related BGP commands:

[bgp default local-preference \(BGP only\)](#)

[neighbor route-map](#)

set metric

Overview Use this command to add a metric set clause to a route map entry.

When a route or BGP update message matches the route map entry, the device takes one of the following actions:

- changes the metric (or for BGP, the MED attribute value) to the specified value, or
- adds or subtracts the specified value from the metric or MED attribute, if you specify + or - before the value (for example, to increase the metric by 2, enter +2)

Use the **no** variant of this command to remove the set clause.

Syntax `set metric {+<metric-value>|-<metric-value>|<metric-value>}`
`no set metric [+<metric-value>|-<metric-value>|<metric-value>]`

Parameter	Description
+	Increase the metric or MED attribute by the specified amount.
-	Decrease the metric or MED attribute by the specified amount.
<metric-value>	<0-4294967295> The new metric or MED attribute value, or the amount by which to increase or decrease the existing value.

Default The default metric value for routes redistributed into OSPF and OSPFv3 is 20.

Mode Route-map Configuration

Usage notes For BGP, if you want the device to compare MED values in update messages from peers in different ASes, also enter the command [bgp always-compare-med](#). You do not need to enter this command if you only want the device to compare MED values in update messages from peers in the same AS, because it always does.

This command is valid for:

- OSPF routes
- routes in BGP update messages
- RIP routes.

Note that defining the OSPF metric in a route map supersedes the metric defined using a [redistribute \(OSPF\)](#) or a [redistribute \(IPv6 OSPF\)](#) command. For more information, see the [OSPFv3 Feature Overview and Configuration Guide](#) and the [OSPF Feature Overview and Configuration Guide](#).

Examples To use entry 3 of the route map called "rmap1" to give matching routes a metric of 600, use the commands:

```
awplus# configure terminal
awplus(config)# route-map rmap1 permit 3
awplus(config-route-map)# set metric 600
```

To use entry 3 of the route map called "rmap1" to increase the metric of matching routes by 2, use the commands:

```
awplus# configure terminal
awplus(config)# route-map rmap1 permit 3
awplus(config-route-map)# set metric +2
```

Related commands

- [match metric](#)
- [route-map](#)
- [show route-map](#)

set metric-type

Overview Use this command to add a metric-type set clause to a route map entry.

When a route matches the route map entry, the device sets its route type to the specified value.

Use the **no** variant of this command to remove the set clause.

Syntax `set metric-type {type-1|type-2}`
`no set metric-type [type-1|type-2]`

Parameter	Description
type-1	Redistribute matching routes into OSPF as type-1 external routes.
type-2	Redistribute matching routes into OSPF as type-2 external routes.

Mode Route-map Configuration

Usage notes This command is valid for OSPF routes only.

Example To use entry 3 of the route map called `rmap1` to redistribute matching routes into OSPF as type-1 external routes, use the commands:

```
awplus# configure terminal
awplus(config)# route-map rmap1 permit 3
awplus(config-route-map)# set metric-type 1
```

Related commands

- [default-information originate](#)
- [redistribute \(OSPF\)](#)
- [match route-type](#)
- [route-map](#)
- [show route-map](#)

set origin

Overview Use this command to add an origin set clause to a route map entry.

When a BGP update message matches the route map entry, the device sets its origin attribute to the specified value.

Use the **no** variant of this command to remove the set clause.

Syntax `set origin {egp|igp|incomplete}`
`no set origin [egp|igp|incomplete]`

Parameter	Description
egp	Learned from an exterior gateway protocol.
igp	Learned from a local interior gateway protocol.
incomplete	Of unknown heritage, for example a static route.

Mode Route-map Configuration

Usage This command is valid for BGP update messages only.

Example To use entry 3 of the route map called `rmap1` to give matching update messages an origin of `egp`, use the commands:

```
awplus# configure terminal
awplus(config)# route-map rmap1 permit 3
awplus(config-route-map)# set origin egp
```

Related commands [match origin](#)
[route-map](#)
[show route-map](#)

set originator-id

- Overview** Use this command to add an originator ID set clause to a route map entry.
- The originator ID is the router ID of the IBGP peer that first learned this route, either via an EBGP peer or by some other means such as importing it.
- When a BGP update message matches the route map entry, the device sets its originator ID attribute to the specified value.
- Use the **no** variant of this command to remove the set clause.

Syntax `set originator-id <ip-address>`
`no set originator-id [<ip-address>]`

Parameter	Description
<code><ip-address></code>	The IP address of the originator, entered in the form A.B.C.D.

Mode Route-map Configuration

Usage This command is valid for BGP update messages only.

Example To use entry 3 of the route map called `rmap1` to give matching update messages an originator ID of `1.1.1.1`, use the commands:

```
awplus# configure terminal
awplus(config)# route-map rmap1 permit 3
awplus(config-route-map)# set originator-id 1.1.1.1
```

Related commands [route-map](#)
[show route-map](#)

set tag

Overview Use this command to add a tag set clause to a route map entry.

When a route matches the route map entry, the device sets its tag to the specified value when it redistributes the route into OSPF.

Use the **no** variant of this command to remove the set clause.

Syntax `set tag <tag-value>`
`no set tag [<tag-value>]`

Parameter	Description
<code><tag-value></code>	<code><0-4294967295></code> Value to tag matching routes with.

Mode Route-map Configuration

Usage notes This command is valid only when redistributing routes into OSPF.

Example To use entry 3 of the route map called `rmap1` to tag matching routes with the number 6, use the commands:

```
awplus# configure terminal
awplus(config)# route-map rmap1 permit 3
awplus(config-route-map)# set tag 6
```

Related commands

- [default-information originate](#)
- [redistribute \(OSPF\)](#)
- [match tag](#)
- [route-map](#)
- [show route-map](#)

set weight

Overview Use this command to add a weight set clause to a route map entry.

The weight value assists in best path selection of BGP routes. It is stored with the route in the BGP routing table, but is not advertised to peers. When there are multiple routes with a common destination, the device uses the route with the highest weight value.

When a route matches the route map entry, the device sets its weight to the specified value.

Use the **no** variant of this command to remove the set clause.

Syntax `set weight <weight>`
`no set weight [<weight>]`

Parameter	Description
<code><weight></code>	<code><0-4294967295></code> The weight value.

Mode Route-map Configuration

Usage This command is valid for BGP routes only.

Example To use entry 3 of the route map called `rmap1` to give matching routes a weight of 60, use the commands:

```
awplus# configure terminal
awplus(config)# route-map rmap1 permit 3
awplus(config-route-map)# set weight 60
```

Related commands [route-map](#)
[show route-map](#)

show route-map

Overview Use this command to display information about one or all route maps.

Syntax `show route-map <map-name>`

Parameter	Description
<code><map-name></code>	A name to identify the route map.

Mode User Exec and Privileged Exec

Example To display information about the route-map named `example-map`, use the command:

```
awplus# show route-map example-map
```

Output Figure 30-1: Example output from the **show route-map** command

```
route-map example-map, permit, sequence 1
  Match clauses:
    ip address prefix-list example-pref
  Set clauses:
    metric 100
route-map example-map, permit, sequence 200
  Match clauses:
  Set clauses:
```

Related commands [route-map](#)

31

Policy-based Routing Commands

Introduction

Overview This chapter provides an alphabetical reference of commands used to configure policy-based routing.

For more information, see the [Policy-based Routing \(PBR\) Feature Overview and Configuration Guide](#).

- Command List**
- [“application-decision”](#) on page 1570
 - [“debug policy-based-routing”](#) on page 1572
 - [“ip policy-route”](#) on page 1573
 - [“ipv6 policy-route”](#) on page 1575
 - [“policy-based-routing”](#) on page 1577
 - [“policy-based-routing enable”](#) on page 1578
 - [“show ip pbr route”](#) on page 1579
 - [“show ipv6 pbr route”](#) on page 1581
 - [“show pbr rules”](#) on page 1583
 - [“show pbr rules brief”](#) on page 1588

application-decision

Overview Use this command to select which method is used for the application decision.

Syntax `application-decision {once-only|continuous}`

Parameter	Description
<code>once-only</code>	When a traffic flow reaches the PBR engine for the first time, whatever application has been set on that flow will be used to match against the PBR rules and a route selected. Subsequent updates to the flow's application will be ignored by the PBR engine.
<code>continuous</code>	Any time a traffic flow has its application updated by the DPI engine, the PBR engine will re-process the flow against all configured PBR rules, which may result in a new match and the traffic being directed over a different route than it was previously.

Default Application determination is set to **continuous**.

Mode Policy-based Routing Configuration

Usage notes When using a DPI engine, traffic flows through the device are periodically assigned an application by the DPI engine. The application assignment is then used when matching against PBR rules. The DPI engine may change its decision about a traffic flow over time, as more packets from the flow are analyzed. This command determines how the PBR engine utilizes the application decision made by DPI.

When set to **once-only**, only the initial application decision made by the DPI engine will be used when matching against PBR routes, and subsequent updates will be ignored.

When set to **continuous**, if the DPI engine re-classifies a traffic flow under a different application, the flow will be re-processed by the PBR engine, and may therefore match against a different PBR rule and take a different route than it was previously.

Once-only is intended for use with DPI learning enabled. Refer to the [SD-WAN Feature Overview and Configuration Guide](#) for examples.

Example To prevent the PBR engine from re-matching a traffic flow whenever the application decision is changed, use the following commands:

```
awplus(config)# policy-based-routing
awplus(config-pbr)# application-decision once-only
```

To allow the PBR engine to re-match traffic flows against PBR rules when the application decision changes, use the following commands:

```
awplus(config)# policy-based-routing
awplus(config-pbr)# application-decision continuous
```

Related commands [ip policy-route](#)
[ipv6 policy-route](#)

Command changes Version 5.4.8-0.2: command added

debug policy-based-routing

Overview Use this command to enable policy-based routing debugging. This will cause messages containing detailed debugging information to be displayed and logged at the "debugging" level.

Use the **no** variant of this command to disable policy-based routing debugging.

Syntax debug policy-based-routing
no debug policy-based-routing

Default Policy-based routing debugging is disabled by default.

Mode Privileged Exec

Examples To enable policy-based routing debugging, use the command:

```
awplus# debug policy-based-routing
```

To disable policy-based routing debugging, use the command:

```
awplus# no debug policy-based-routing
```

Related commands

- [ip policy-route](#)
- [ipv6 policy-route](#)
- [policy-based-routing](#)
- [show ip pbr route](#)
- [show ipv6 pbr route](#)

ip policy-route

Overview Use this command to configure IP policy routes. These routes specify how the device will route traffic from specified applications and entities. You can specify the route's next-hop by specifying the egress interface, or by specifying the next-hop device's IP address (except on dynamic interfaces such as PPPoE). You can also list alternative next-hops to use if your first choice is down.

You can also specify the pseudo interface Null. Null should be the last nexthop specified, as this will drop packets when used as the nexthop.

Use the **no** variant of this command to remove a policy route.

Syntax

```
ip policy-route [<1-500>] [match <application-name>] [from  
<source-entity>] [to <destination-entity>] nexthop  
{<interface-list>|<ip-add-list>}  
  
no ip policy-route <1-500>
```

Parameter	Description
<1-500>	The policy route ID number. If you do not specify an ID number, the device assigns the new policy route the next available number, in multiples of 10. For example, if the highest numbered policy route is 81, the next policy route would be given an ID of 90. Policy routes are checked in order of ID number, starting with the lowest ID number. The device applies the policy route as soon as it finds a matching route; it does not check the remaining policy routes.
<application-name>	An application name. You can use the tab key to auto-complete application names.
<source-entity>	A source entity name. You can use the tab key to auto-complete entity names.
<destination-entity>	A destination entity name.
<interface-list>	The name of the egress interface or interfaces. You can list up to 8 interfaces per policy route; the device sends the traffic out the first interface in the list that is up.
<ip-add-list>	The IP address of the next-hop. You can list up to 8 next-hop addresses per policy route; the device sends the traffic to the first address in the list that is reachable. Do not use this when the next-hop is on a dynamic interface (e.g. PPPoE); specify the interface name instead.

Default No policy routes

Mode Policy-based Routing Configuration

Usage notes You must specify at least one of the **match**, **from** or **to** parameters. Packets will be routed to the specified next-hop if they match the application, come from the source entity, and are destined for the destination entity.

Before creating a policy route, you need to create the application and entities that specify the traffic you want to route. To create an application, use the [application](#) command. To create entities, use the [zone](#), [network \(zone\)](#), and [host \(network\)](#) commands. To see existing applications and entities, use the [show application](#) and [show entity](#) commands.

Examples To create a policy route to route traffic that matches an application called 'voice', comes from the entity called 'inside', and is destined for the entity called 'outside', use the following commands:

```
awplus# configure terminal
awplus(config)# policy-based-routing
awplus(config-pbr)# policy-based-routing enable
awplus(config-pbr)# ip policy-route 10 match voice from inside
to outside nexthop 10.37.236.65
```

To delete the policy route created above, use the following commands:

```
awplus# configure terminal
awplus(config)# policy-based-routing
awplus(config-pbr)# no ip policy-route 10
```

To route the above traffic via ppp0 if ppp0 is up, or ppp1 if ppp0 is down, use the following commands:

```
awplus# configure terminal
awplus(config)# policy-based-routing
awplus(config-pbr)# policy-based-routing enable
awplus(config-pbr)# ip policy-route 20 match voice from inside
to outside nexthop ppp0 ppp1
```

To delete the policy route created above, use the following commands:

```
awplus# configure terminal
awplus(config)# policy-based-routing
awplus(config-pbr)# no ip policy-route 20
```

Related commands

- [policy-based-routing](#)
- [policy-based-routing enable](#)
- [show application](#)
- [show entity](#)
- [show ip pbr route](#)

Command changes Version 5.4.8-0.2: number of routes increased, null interface added

ipv6 policy-route

Overview Use this command to configure IPv6 policy routes. These routes specify how the device will route traffic from specified applications and entities. You can specify the route's next-hop by specifying the egress interface, or by specifying the next-hop device's IPv6 address (except on dynamic interfaces such as PPPoE). You can also list alternative next-hops to use if your first choice is down.

You can also specify the pseudo interface Null. Null should be the last nexthop specified, as this will drop packets when used as the nexthop.

Use the **no** variant of this command to remove a policy route.

Syntax

```
ipv6 policy-route [<1-500>] [match <application-name>] [from  
<source-entity>] [to <destination-entity>] nexthop  
{<interface-list>|<ipv6-add-list>}  
  
no ipv6 policy-route <1-500>
```

Parameter	Description
<1-500>	The policy route ID number. If you do not specify an ID number, the device assigns the new policy route the next available number, in multiples of 10. For example, if the highest numbered policy route is 81, the next policy route would be given an ID of 90. Policy routes are checked in order of ID number, starting with the lowest ID number. The device applies the policy route as soon as it finds a matching route; it does not check the remaining policy routes.
<application-name>	An application name. You can use the tab key to auto-complete application names.
<source-entity>	A source entity name. You can use the tab key to auto-complete entity names.
<destination-entity>	A destination entity name.
<interface-list>	The name of the egress interface or interfaces. You can list up to 8 interfaces per policy route; the device sends the traffic out the first interface in the list that is up.
<ipv6-add-list>	The IPv6 address of the next-hop, specified in the form X:X::X:X. You can list up to 8 next-hop addresses per policy route; the device sends the traffic to the first address in the list that is reachable. Do not use this when the next-hop is on a dynamic interface (e.g. PPPoE); specify the interface name instead.

Default No policy routes

Mode Policy-based Routing Configuration

Usage notes You must specify at least one of the **match**, **from** or **to** parameters. Packets will be routed to the specified next-hop if they match the application, come from the source entity, and are destined for the destination entity.

Before creating a policy route, you need to create the application and entities that specify the traffic you want to route. To create an application, use the [application](#) command. To create entities, use the [zone](#), [network \(zone\)](#), and [host \(network\)](#) commands. To see existing applications and entities, use the [show application](#) and [show entity](#) commands.

Examples To create a policy route to route traffic that matches an application called 'voice', comes from the entity called 'inside', and is destined for the entity called 'outside', use the following commands:

```
awplus# configure terminal
awplus(config)# policy-based-routing
awplus(config-pbr)# policy-based-routing enable
awplus(config-pbr)# ipv6 policy-route 10 match voice from
inside to outside nexthop 2001:100::1
```

To delete the policy route created above, use the following commands:

```
awplus# configure terminal
awplus(config)# policy-based-routing
awplus(config-pbr)# no ipv6 policy-route 10
```

To route the above traffic via ppp0 if ppp0 is up, or ppp1 if ppp0 is down, use the following commands:

```
awplus# configure terminal
awplus(config)# policy-based-routing
awplus(config-pbr)# policy-based-routing enable
awplus(config-pbr)# ipv6 policy-route 20 match voice from
inside to outside nexthop ppp0 ppp1
```

To delete the policy route created above, use the following commands:

```
awplus# configure terminal
awplus(config)# policy-based-routing
awplus(config-pbr)# no ipv6 policy-route 20
```

Related commands

- [policy-based-routing](#)
- [policy-based-routing enable](#)
- [show application](#)
- [show entity](#)
- [show ipv6 pbr route](#)

Command changes Version 5.4.8-0.2: number of routes increased, null interface added

policy-based-routing

Overview Use this command to enter Policy-based-routing mode. Policy-based routing lets you determine how the device will route traffic from specified applications and entities.

Use the **no** variant of this command to remove the whole policy-based routing configuration.

Syntax `policy-based-routing`
`no policy-based-routing`

Mode Global configuration

Usage Once you have entered policy-based-routing mode, use the [policy-based-routing enable](#) command to turn on policy-based routing, and the [ip policy-route](#) or [ipv6 policy-route](#) commands to create policy routes.

Example To enter policy-based-routing mode, use the commands:

```
awplus# configure terminal
awplus(config)# policy-based-routing
awplus(config-pbr)#
```

Related commands [ip policy-route](#)
[ipv6 policy-route](#)
[policy-based-routing enable](#)

policy-based-routing enable

Overview Use this command to enable policy-based routing (PBR). Policy-based routing lets you determine how the device will route traffic from specified applications and entities.

Use the **no** variant of this command to disable policy-based routing.

Syntax `policy-based-routing enable`
`no policy-based-routing enable`

Default Policy-based routing is disabled by default

Mode Policy-based Routing Configuration

Examples To enable policy-based routing use the following commands.

```
awplus# configure terminal
awplus(config)# policy-based-routing
awplus(config-pbr)# policy-based-routing enable
```

To disable policy-based routing use the following commands.

```
awplus# configure terminal
awplus(config)# policy-based-routing
awplus(config-pbr)# no policy-based-routing enable
```

Related commands [ip policy-route](#)
[ipv6 policy-route](#)

show ip pbr route

Overview Use this command to display the installed IPv4 routes for policy-based routing.

Syntax show ip pbr route [<1-500>]

Parameter	Description
<1-500>	The policy route ID. If you specify a policy route ID, the output only lists routes for that ID. If you do not specify an ID, the output also lists the conventional static and dynamic routes, in the table called "main".

Mode User Exec and Privileged Exec

Usage notes If you do not specify a policy routeID, the output starts by listing the ordinary static and dynamic routes, in a table called "main".

Example To show all the IPv4 routes, use the following command:

```
awplus# show ip pbr route
```

Output Figure 31-1: Example output from **show ip pbr route**

```
awplus#show ip pbr route
Route table: main
 10.33.11.0/24 via 10.37.236.65, eth1
 10.37.236.64/27 is directly connected, eth1
 172.31.0.0/17 is directly connected, vlan4092
 192.168.1.0/24 is directly connected, vlan2

Route table: policy-route 10

Route table: policy-route 20
 default via 10.37.236.65, ppp0
```

If you do not specify a policy routeID, the output starts by listing the ordinary static and dynamic routes, in the route table called "main".

Then it lists the routes for each policy route.

For each route, the output lists the route's next-hop IP address and/or the next-hop interface.

Example To show only the routes for policy route 20, use the following command:

```
awplus# show ip pbr route 20
```

Output Figure 31-2: Example output from **show ip pbr route** for a specified policy route

```
awplus#show ip pbr route 20  
  
Route table: policy-route 20  
    default via 10.37.236.65, ppp0
```

For each route, the output lists the route's next-hop IP address and/or the next-hop interface.

Related commands [ip policy-route](#)
[policy-based-routing](#)

Command changes Version 5.4.8-0.2: Policy route ID increased from 128 to 500

show ipv6 pbr route

Overview Use this command to display the installed IPv6 routes for policy-based routing.

Syntax `show ipv6 pbr route [<1-128>]`

Parameter	Description
<1-128>	The policy route ID. If you specify a policy route ID, the output only lists routes for that ID. If you do not specify an ID, the output also lists the ordinary static and dynamic routes, in the table called "main".

Mode User Exec and Privileged Exec

Usage If you do not specify a policy routeID, the output starts by listing the ordinary static and dynamic routes, in a table called "main".

Example To show all the IPv6 routes, use the following command:

```
awplus# show ipv6 pbr route
```

Output Figure 31-3: Example output from **show ipv6 pbr route**

```
awplus#show ipv6 pbr route
Route table: main
  2001:100::/64 dev eth1
  fe80::/64 dev eth1

Route table: policy-route 10

Route table: policy-route 20
  default via 2001:100::2, eth1
```

If you do not specify a policy routeID, the output starts by listing the ordinary static and dynamic routes, in the route table called "main".

Then it lists the routes for each policy route.

For each route, the output lists the route's next-hop IPv6 address and/or the next-hop interface.

Example To show only the routes for policy-route 20, use the following command:

```
awplus# show ip pbr route 20
```

Output Figure 31-4: Example output from **show ipv6 pbr route** for a specified policy route

```
awplus#show ipv6 pbr route 20  
  
Route table: policy-route 20  
default via 2001:100::2, eth1
```

For each route, the output lists the route's next-hop IPv6 address and/or the next-hop interface.

Related commands [ipv6 policy-route](#)
[policy-based-routing](#)

show pbr rules

Overview Use this command to display the configured IPv4 and IPv6 policy routes. It also shows the validity of the policy routes.

Syntax

```
show pbr rules
show pbr rules <rule-id>
show pbr rules profile <profile-name>
show pbr rules group <group-name>
```

Parameter	Description
<rule-id>	The policy route ID. If you specify a policy route ID, the output only lists configuration and status for this specified rule.
<profile-name>	The Link Health Monitoring profile name. If you specify an existing Link Health Monitoring performance profile name, the output only lists profile configuration for this specified profile.
<group-name>	The Link Health Monitoring group name. If you specify an existing Link Health Monitoring group name, the output only lists group configuration for this specified profile.

Mode User Exec and Privileged Exec

Example To show information about the policy routes, use the following command:

```
awplus# show pbr rules
```

To show information about the policy route rule with the rule ID of '1', use the following command:

```
awplus# show pbr rules 1
```

To show information about the Link Health Monitoring profile with the profile name of 'profile1', use the following command:

```
awplus# show pbr rules profile profile1
```

To show information about the Link Health Monitoring group with the profile name of 'group1', use the following command:

```
awplus# show pbr rules group group1
```

Output Figure 31-5: Example output from **show pbr rules**

```
awplus#show pbr rules
Statistics:
-----
Route table usage: 1/500
Total number of configured PBR-rules = 1
-----

PBR-Rule 1
-----
Active:                Yes
Match:                 sip
From:                  LAN
To:                    any
Profile:               PROFILE1
  latency bad above:   300 ms
  latency good below:  - ms
  jitter bad above:    - ms
  jitter good below:   - ms
  pktloss bad above:   - %
  pktloss good below:  - %
Group:                 GROUP1
  Member:              10
    next-hop:          172.16.10.1
    probe:              PROBE10
    latency:            401 ms
    jitter:             0 ms
    pktloss:            0.0 %
  Member:              20
    next-hop:          172.16.20.1
    probe:              PROBE20
    latency:            400 ms
    jitter:             0 ms
    pktloss:            0.0 %
Last Change:
  Current Nexthop:     172.16.10.1
  Previous Nexthop:    -
  Change Time:         22 Nov 2017 13:57:48
  Causes:               Rx probe 'PROBE10', latency (401>300) ms
  Decision:             only available link
Change Count:         1
```

Figure 31-6: Example output from **show pbr rules 1**

```
awplus#show pbr rules 1
PBR-Rule 1
-----
Active:                Yes
Match:                 sip
From:                  LAN
To:                    any
Profile:               PROFILE1
  latency bad above:   300 ms
  latency good below:  - ms
  jitter bad above:    - ms
  jitter good below:   - ms
  pktloss bad above:   - %
  pktloss good below:  - %
Group:                 GROUP1
  Member:              10
    next-hop:          172.16.10.1
    probe:              PROBE10
    latency:            401 ms
    jitter:              0 ms
    pktloss:            0.0 %
  Member:              20
    next-hop:          172.16.20.1
    probe:              PROBE20
    latency:            400 ms
    jitter:              0 ms
    pktloss:            0.0 %
Last Change:
  Current Nexthop:     172.16.10.1
  Previous Nexthop:    -
  Change Time:         22 Nov 2017 13:57:48
  Causes:               Rx probe 'PROBE10', latency (401>300) ms
  Decision:             only available link
Change Count:          1
```

Figure 31-7: Example output from **show pbr rules profile profile1**

```
awplus#show pbr rules profile profile1
Profile:                profile1
  latency bad above:   300 ms
  latency good below:  - ms
  jitter bad above:    - ms
  jitter good below:   - ms
  pktloss bad above:   - %
  pktloss good below:  - %
```

Figure 31-8: Example output from **show pbr rules group group1**

```
awplus#show pbr rules group group1
Group:          group1
  Member:       10
    next-hop:   172.16.10.1
    probe:      PROBE10
    latency:    401 ms
    jitter:     0 ms
    pktloss:    0.0 %
  Member:       20
    next-hop:   172.16.20.1
    probe:      PROBE20
    latency:    400 ms
    jitter:     0 ms
    pktloss:    0.0 %
```

Table 31-1: Parameters in the output from **show pbr rules**

Parameter	Description
Total number of configured PBR-rules	The number of PBR rules currently configured. This includes both conventional PBR policy-routes and Link Health Monitoring IP policy-routes, regardless of whether the rules are valid or not.
PBR-Rule	The PBR rule ID which the following statistics and configuration are associated with.
Active	Whether the rule is active or not.
Match	The name of an application. Packets will be routed to the specified next hop if they match this application, come from the source entity, and are destined for the destination entity.
From	The name of the source entity. Packets will be routed to the specified next hop if they match the application, come from this source entity, and are destined for the destination entity.
To	The name of the destination entity. Packets will be routed to the specified next hop if they match the application, come from the source entity, and are destined for this destination entity.
Profile	The name of the Link Health Monitoring profile associated with this Link Health Monitoring PBR policy-route.
bad above, good below	The configured threshold for this specific rule. There are fields for latency, jitter, and packet loss. If this field has a value of "-", then the threshold has not been configured.
Group	The name of the Link Health Monitoring group associated with this Link Health Monitoring PBR policy-route.

Table 31-1: Parameters in the output from **show pbr rules** (cont.)

Parameter	Description
Member	The ID of the Link Health Monitoring member associated with this Link Health Monitoring group.
Nexthop	The IPv4 or IPv6 address of the next-hop or the egress interface. There can be up to 8 next-hops per policy route.
probe	The Link Health Monitoring probe associated with the Link Health Monitoring group member.
latency	The latency of the probe associated with the Link Health Monitoring member.
jitter	The jitter of the probe associated with the Link Health Monitoring member.
packet loss	The packet loss of the probe associated with the Link Health Monitoring member.
Current Nexthop	The chosen nexthop for traffic matching the Link Health Monitoring PBR policy-route.
Previous Nexthop	The previously chosen nexthop prior to failover. If a failover hasn't occurred on this setup, there is no previous nexthop. This is indicated by "-".
Change Time	The time at which the current nexthop was chosen. This will change if a failover occurs, or at boot.
Causes	The event that caused the last failover.
Decision	The reason why the current nexthop was chosen.
Change Count	The number of times the chosen nexthop has changed. This counter will increment any time a link failover occurs.

Related commands

[ip policy-route](#)
[ipv6 policy-route](#)
[policy-based-routing](#)
[show ip pbr route](#)
[show ipv6 pbr route](#)

Command changes

Version 5.4.8-0.2: new parameters for profiles and groups added
Version 5.4.8-1.1: up to 500 route table entries supported

show pbr rules brief

Overview Use this command to show a summary of all PBR rules. It also indicates, by the presence or absence of the nexthop field, which nexthop to route to.

Syntax show pbr rules brief

Mode User Exec and Privileged Exec

Example To show information about the policy routes, use the following command:

```
awplus# show pbr rules brief
```

Output Figure 31-9: Example output from **show pbr rules brief**

```
awplus#show pbr rules brief
Policy based routing is enabled
Route table usage: 2/500
* - No route table available for the rule - see "show ip pbr
route"
Rule Match      From           To             Valid  Nexthop
-----
10  any          entities.any   entities.outside  Yes    10.10.20.2
20  udp          any           any               Yes    2001:100::2
```

Table 31-2: Parameters in the output from **show pbr rules brief**

Parameter	Description
Rule	The policy route ID number. Policy routes are checked in order of ID number, starting with the lowest ID number. The device applies the policy route as soon as it finds a matching route; it does not check the remaining policy routes.
Match	The name of an application. Packets will be routed to the specified next hop if they match this application, come from the source entity, and are destined for the destination entity.
From	The name of the source entity. Packets will be routed to the specified next hop if they match the application, come from this source entity, and are destined for the destination entity.
To	The name of the destination entity. Packets will be routed to the specified next hop if they match the application, come from the source entity, and are destined for this destination entity.

Table 31-2: Parameters in the output from **show pbr rules brief** (cont.)

Parameter	Description
Valid	Whether the application and entities are valid.
Nexthop	The IPv4 or IPv6 address of the next-hop or the egress interface. There can be up to 8 next-hops per policy route.

Related commands [show pbr rules](#)

Command changes Version 5.4.8-0.2: command added
Version 5.4.8-1.1: up to 500 route table entries supported

32

VRF-lite Commands

Introduction

Overview This chapter provides an alphabetical reference of commands used to configure Virtual Routing and Forwarding Lite (VRF-lite). See the [VRF Lite Feature Overview and Configuration Guide](#) for more information and examples.

- Command List**
- [“address-family”](#) on page 1593
 - [“address-family ipv4 \(RIP\)”](#) on page 1595
 - [“arp”](#) on page 1596
 - [“arp opportunistic-nd”](#) on page 1598
 - [“clear arp-cache”](#) on page 1600
 - [“clear ip bgp * \(BGP only\)”](#) on page 1602
 - [“clear ip bgp \(IPv4\) \(BGP only\)”](#) on page 1604
 - [“clear ip rip route”](#) on page 1606
 - [“crypto key pubkey-chain knownhosts”](#) on page 1608
 - [“default-metric \(RIP\)”](#) on page 1610
 - [“description \(VRF\)”](#) on page 1611
 - [“distance \(RIP\)”](#) on page 1612
 - [“distribute-list \(RIP\)”](#) on page 1613
 - [“export map”](#) on page 1614
 - [“fullupdate \(RIP\)”](#) on page 1615
 - [“http client vrf”](#) on page 1616
 - [“http vrf”](#) on page 1617
 - [“fullupdate \(RIP\)”](#) on page 1618
 - [“ip route static inter-vrf”](#) on page 1619

- [“import map”](#) on page 1620
- [“ip route vrf”](#) on page 1621
- [“ip tftp vrf”](#) on page 1624
- [“ip vrf”](#) on page 1625
- [“log host”](#) on page 1626
- [“log host exclude”](#) on page 1628
- [“log host \(filter\)”](#) on page 1631
- [“log host time”](#) on page 1635
- [“ip vrf forwarding”](#) on page 1637
- [“max-fib-routes \(VRF\)”](#) on page 1638
- [“max-static-routes \(VRF\)”](#) on page 1640
- [“neighbor next-hop-self”](#) on page 1641
- [“neighbor remote-as”](#) on page 1644
- [“neighbor password”](#) on page 1647
- [“network \(RIP\)”](#) on page 1651
- [“passive-interface \(RIP\)”](#) on page 1653
- [“ping”](#) on page 1654
- [“radius-server host”](#) on page 1656
- [“rd \(route distinguisher\)”](#) on page 1660
- [“redistribute \(into BGP or BGP4+\)”](#) on page 1661
- [“redistribute \(OSPF\)”](#) on page 1663
- [“redistribute \(RIP\)”](#) on page 1665
- [“route \(RIP\)”](#) on page 1667
- [“route-target”](#) on page 1668
- [“router ospf”](#) on page 1670
- [“router-id \(VRF\)”](#) on page 1672
- [“show arp”](#) on page 1673
- [“show crypto key pubkey-chain knownhosts”](#) on page 1675
- [“show ip bgp cidr-only \(BGP only\)”](#) on page 1677
- [“show ip bgp community \(BGP only\)”](#) on page 1678
- [“show ip bgp community-list \(BGP only\)”](#) on page 1680
- [“show ip bgp dampening \(BGP only\)”](#) on page 1681
- [“show ip bgp filter-list \(BGP only\)”](#) on page 1683
- [“show ip bgp inconsistent-as \(BGP only\)”](#) on page 1684
- [“show ip bgp longer-prefixes \(BGP only\)”](#) on page 1685

- [“show ip bgp prefix-list \(BGP only\)”](#) on page 1686
- [“show ip bgp quote-regexp \(BGP only\)”](#) on page 1687
- [“show ip bgp regexp \(BGP only\)”](#) on page 1689
- [“show ip bgp route-map \(BGP only\)”](#) on page 1691
- [“show http client”](#) on page 1692
- [“show ip bgp summary \(BGP only\)”](#) on page 1693
- [“show ip interface vrf”](#) on page 1695
- [“show ip rip vrf database”](#) on page 1697
- [“show ip rip vrf interface”](#) on page 1698
- [“show ip route”](#) on page 1699
- [“show ip route database”](#) on page 1702
- [“show ip route summary”](#) on page 1705
- [“show ip vrf”](#) on page 1707
- [“show ip vrf detail”](#) on page 1708
- [“show ip vrf interface”](#) on page 1709
- [“snmp-server host”](#) on page 1710
- [“show running-config vrf”](#) on page 1713
- [“ssh”](#) on page 1714
- [“ssh client”](#) on page 1716
- [“ssh server vrf”](#) on page 1718
- [“tacacs-server host”](#) on page 1719
- [“tcpdump”](#) on page 1721
- [“telnet”](#) on page 1722
- [“timers \(RIP\)”](#) on page 1723
- [“traceroute”](#) on page 1725
- [“version \(RIP\)”](#) on page 1726
- [“vrf”](#) on page 1728

address-family

Overview This command enters the IPv4 or IPv6 Address-Family Configuration command mode. In this mode you can configure address-family specific parameters.

When using VRF-lite, you can enter IPv4 Address Family Configuration mode for a specified VRF instance before configuring that instance.

Syntax [BGP] address-family ipv4 [unicast]
no address-family ipv4 [unicast]

Syntax (VRF-lite) address-family ipv4 [unicast|vrf <vrf-name>]
no address-family ipv4 [unicast|vrf <vrf-name>]

Syntax [BGP4+] address-family ipv6 [unicast]
no address-family ipv6 [unicast]

Parameter	Description
ipv4	Configure parameters relating to the exchange of IPv4 prefixes.
ipv6	Configure parameters relating to the exchange of IPv6 prefixes.
unicast	Configure parameters relating to the exchange of routes to unicast destinations.
vrf	Applies the command to the specified VRF instance.
<vrf-name>	The name of the VRF instance to enter IPv4 Address-Family mode for.

Mode [BGP] Router Configuration

Mode [BGP4+] Router Configuration

Usage notes To leave the IPv4 or IPv6 Address Family Configuration mode, and return to the Router Configuration mode, use the [exit-address-family](#) command.

Example [BGP]

```
awplus# configure terminal
awplus(config)# router bgp 100
awplus(config-router)# neighbor 192.168.0.1 remote-as 100
awplus(config-router)# address-family ipv4 vrf
green
awplus(config-router-af)# neighbor 192.168.0.1 activate
awplus(config-router-af)# exit-address-family
awplus(config-router)#
```

Example [BGP4+] awplus# configure terminal
awplus(config)# router bgp 100
awplus(config-router)# neighbor 2001:0db8:010d::1 remote-as 100
awplus(config-router)# address-family ipv6
awplus(config-router-af)# neighbor 2001:0db8:010d::1 activate
awplus(config-router-af)# exit-address-family
awplus(config-router)#

Related commands [exit-address-family](#)

Command changes Added to AlliedWare Plus prior to 5.4.6-1
Version 5.4.6-2.1: VRF-lite support added to BGP for AR-series products
Version 5.4.7-2.1: BGP support added for IEx510, x550 series
Version 5.4.7-2.4: BGP support added for IE300 series

address-family ipv4 (RIP)

Overview This command enters the IPv4 address-family command mode. In this mode you can configure address-family specific parameters for a specific VRF (RIP) instance.

Syntax `address-family ipv4 vrf <vrf-name>`
`no address-family ipv4 vrf <vrf-name>`

Parameter	Description
<code>ipv4</code>	Configure parameters relating to the RIP exchange of IPv4 prefixes.
<code>vrf</code>	Apply this command to a VRF instance.
<code><vrf-name></code>	The name of the VRF instance.

Mode Router Configuration

Usage To leave Address Family mode and return to Router Configuration mode, use the [exit-address-family](#) command.

Example In this example the address family "green" is entered, and then exited by using the [exit-address-family](#) command.

```
awplus# configure terminal
awplus(config)# router rip
awplus(config-router)# address-family ipv4 vrf green
awplus(config-router-af)# exit-address-family
awplus(config-router)#
```

Related commands [exit-address-family](#)

Command changes Version 5.4.6-2.1: VRF-lite support added.

arp

Overview This command adds a static ARP entry to the ARP cache. This is typically used to add entries for hosts that do not support ARP or to speed up the address resolution function for a host. The ARP entry must not already exist. Use the **alias** parameter to allow your device to respond to ARP requests for this IP address.

If VRF-lite is configured, you can add ARP entries to either the global cache or for a specific VRF instance.

The **no** variant of this command removes the static ARP entry. Use the [clear arp-cache](#) command to remove the dynamic ARP entries in the ARP cache.

Syntax `arp <ip-addr> <mac-address> [alias]`
`no arp <ip-addr>`

Syntax (VRF-lite) `arp [vrf <vrf-name>] <ip-addr> <mac-address> [<port-number>]`
`[alias]`
`no arp [vrf <vrf-name>] <ip-addr>`

Parameter	Description
<code><ip-addr></code>	The IPv4 address of the device you are adding as a static ARP entry.
<code><mac-address></code>	The MAC address of the device you are adding as a static ARP entry, in hexadecimal notation with the format HHHH.HHHH.HHHH.
<code>alias</code>	Allows your device to respond to ARP requests for the IP address. Proxy ARP must be enabled on the interface before using this parameter.
<code>vrf</code>	Apply this command to a VRF instance.
<code><vrf-name></code>	The name of the VRF instance.

Mode Global Configuration

Examples To add the IP address 10.10.10.9 with the MAC address 0010.2533.4566 into the ARP cache, and have your device respond to ARP requests for this address, use the commands:

```
awplus# configure terminal
awplus(config)# arp 10.10.10.9 0010.2533.4566 alias
```

Example (VRF-lite) To apply the above example within a VRF instance called `red` use the following commands:

```
awplus# configure terminal
awplus(config)# arp vrf red 10.10.10.9 0010.2533.4566 alias
```

Related commands clear arp-cache
ip proxy-arp
show arp

Command changes Version 5.4.6-2.1: VRF-lite support added.

arp opportunistic-nd

Overview Use this command to enable opportunistic neighbor discovery for the global ARP cache. This command changes the behavior for unsolicited ARP packet forwarding on the device.

CAUTION: *Opportunistic neighbor discovery can make your device more vulnerable to ARP/ND cache poisoning attacks. We recommend disabling it unless necessary.*

When using VRF-lite, you can use this command to enable opportunistic neighbor discovery for a named VRF instance.

Use the **no** variant of this command to disable opportunistic neighbor discovery for the global ARP cache.

Syntax `arp opportunistic-nd`
`no arp opportunistic-nd`

Syntax (VRF-lite) `arp opportunistic-nd [vrf <vrf-name>]`
`no arp opportunistic-nd [vrf <vrf-name>]`

Parameter	Description
<code>vrf</code>	Apply this command to a VRF instance.
<code><vrf-name></code>	The name of the VRF instance.

Default Opportunistic neighbor discovery is disabled by default.

Mode Global Configuration

Usage notes When opportunistic neighbor discovery is enabled, the device will reply to any received unsolicited ARP packets (but not gratuitous ARP packets). The source MAC address for the unsolicited ARP packet is added to the ARP cache, so the device forwards the ARP packet. When opportunistic neighbor discovery is disabled, the source MAC address for the ARP packet is not added to the ARP cache, so the ARP packet is not forwarded by the device.

Note this command enables or disables opportunistic neighbor discovery for a VRF instance if the **vrf** parameter and an instance name are applied. If a VRF instance is not specified, then opportunistic neighbor discovery is enabled or disabled for device ports configured for IPv4.

Examples To enable opportunistic neighbor discovery for the global ARP cache, enter:

```
awplus# configure terminal
awplus(config)# arp opportunistic-nd
```

To disable opportunistic neighbor discovery for the global ARP cache, enter:

```
awplus# configure terminal
awplus(config)# no arp opportunistic-nd
```

Example (VRF-lite) To enable opportunistic neighbor discovery for the VRF instance 'blue', enter:

```
awplus# configure terminal
awplus(config)# arp opportunistic-nd vrf blue
```

To disable opportunistic neighbor discovery for the VRF instance 'blue', enter:

```
awplus# configure terminal
awplus(config)# no arp opportunistic-nd vrf blue
```

Related commands

- [ipv6 opportunistic-nd](#)
- [show arp](#)
- [show running-config interface](#)

Command changes Version 5.4.6-2.1: VRF-lite support added.

clear arp-cache

Overview This command deletes dynamic ARP entries from the ARP cache. You can optionally specify the IPv4 address of an ARP entry to be cleared from the ARP cache.

When running VRF-lite, this command deletes dynamic ARP entries either from the ARP cache of a specific VRF instance, or from the ARP cache of the Global VRF instance. To delete all ARP entries from both the Global VRF instance and all VRF instances, use the command with no parameters. You can optionally specify the IPv4 address for the VRF instance to clear an ARP entry from the ARP cache.

Syntax `clear arp-cache [<ip-address>]`

Syntax (VRF-lite) `clear arp-cache [vrf <vrf-name>|global] [<ip-address>]`

Parameter	Description
<ip-address>	Specifies a specific IPv4 address for a VRF instance whose entries are to be cleared from the ARP cache.
global	When VRF-lite is configured, apply this command to the global routing and forwarding table.
vrf	Apply this command to the specified VRF instance.
<vrf-name>	The VRF instance name.

Mode Privileged Exec

Usage notes To display the entries in the ARP cache, use the [show arp](#) command. To remove static ARP entries, use the no variant of the [arp](#) command.

Example To clear all dynamic ARP entries, use the command:

```
awplus# clear arp-cache
```

To clear all dynamic ARP entries associated with the IPv4 address 192.168.1.1, use the command:

```
awplus# clear arp-cache 192.168.1.1
```

Example (VRF-lite) To clear the dynamic ARP entries from the VRF instance named blue, use the commands:

```
awplus# clear arp-cache vrf blue
```

To clear the dynamic ARP entries from the VRF instance named blue with the IPv4 address 192.168.1.1, use the commands:

```
awplus# clear arp-cache vrf blue 192.168.1.1
```

When running VRF-lite, to clear the dynamic ARP entries from the global VRF-lite and all VRF instances, use the command:

```
awplus# clear arp-cache
```

**Related
commands** [arp](#)
 [show arp](#)

clear ip bgp * (BGP only)

Overview Use this command to reset all BGP connections, either by fully resetting sessions or by performing soft resets.

If VRF-lite is configured, you can reset BGP connections for all VRF instances or for a specified VRF instance.

Syntax

```
clear ip bgp *  
clear ip bgp * in  
clear ip bgp * out  
clear ip bgp * soft [in|out]  
clear ip bgp * in [prefix-filter]
```

Syntax (VRF-lite)

```
clear ip bgp * [vrf <vrf-name>]  
clear ip bgp * [vrf <vrf-name>] in  
clear ip bgp * [vrf <vrf-name>] out  
clear ip bgp * [vrf <vrf-name>] soft [in|out]  
clear ip bgp * in [prefix-filter]
```

Parameter	Description
*	Clears all BGP peers.
in	Indicates that incoming advertised routes will be cleared.
prefix-filter	Specifies that a prefix-list will be sent, by the ORF mechanism, to those neighbors with which the ORF capability has been negotiated. The neighbors will be triggered to resend updates, which match the prefix-list filter, to the local router. The local router will then perform a soft reconfiguration.
out	Indicates that outgoing advertised routes will be cleared.
soft in	Soft inbound reset causes the neighbors to resend all their updates to the local device, without resetting the connection or clearing the entries in the local device. So, the local device stores new updates, and uses them to systematically replace existing table entries. This process can use a considerable amount of memory.
soft out	Soft outbound reset causes the device to simply resend all its updates to the specified neighbor(s), without resetting the connection, or clearing table entries.
vrf	Applies the command to the specified VRF instance.
<vrf-name>	The name of the VRF instance.

Mode Privileged Exec

Examples To clear all BGP peers, use the command:

```
awplus# clear ip bgp *
```

Example (VRF-lite) To clear all BGP peers in VRF instance red, use the command:

```
awplus# clear ip bgp * vrf red
```

To clear all outbound BGP peers in VRF instance red, use the command:

```
awplus# clear ip bgp * out vrf red
```

Command changes Added to AlliedWare Plus prior to 5.4.6-1

Version 5.4.6-2.1: VRF-lite support added to BGP for AR-series products

Version 5.4.7-2.1: BGP support added for IEx510, x550 series

Version 5.4.7-2.4: BGP support added for IE300 series

clear ip bgp (IPv4) (BGP only)

Overview Use this command to reset the IPv4 BGP connection to the peer specified by the IP address. When VRF-lite is configured, you can apply this command to a specific VRF instance.

Syntax [BGP] `clear ip bgp <ipv4-addr> [in [prefix-filter]|out|soft [in|out]]`

Syntax (VRF-lite) `clear ip bgp <ipv4-address> [vrf <vrf-name>] [in|out|soft [in|out]]`

Parameter	Description
<ipv4-addr>	Specifies the IPv4 address of the neighbor whose connection is to be reset, entered in the form A.B.C.D.
in	Indicates that incoming advertised routes will be cleared.
prefix-filter	Specifies that a prefix-list will be sent, by the ORF mechanism, to those neighbors with which the ORF capability has been negotiated. The neighbors will be triggered to resend updates, which match the prefix-list filter, to the local router. The local router will then perform a soft reconfiguration.
out	Indicates that outgoing advertised routes will be cleared.
soft in	Soft inbound reset causes the neighbors to resend all their updates to the local switch, without resetting the connection or clearing the entries in the local switch. So, the local switch stores new updates, and uses them to systematically replace existing table entries. This process can use a considerable amount of memory.
soft out	Soft outbound reset causes the switch to simply resend all its updates to the specified neighbor(s), without resetting the connection, or clearing table entries.
vrf	Applies the command to the specified VRF instance.
<vrf-name>	The name of the VRF instance.

Mode [BGP] Privileged Exec

Examples [BGP] To clear the BGP connection to the peer at IPv4 address 192.168.1.1 and clear all incoming routes, use the following command:

```
awplus# clear ip bgp 192.168.1.1 in
```

To apply the above example to clear the BGP connection to the peer at IP address 192.0.2.11 for the VRF instance blue, use the following commands:

```
awplus# clear ip bgp 192.0.2.11 vrf blue in
```

Command changes Added to AlliedWare Plus prior to 5.4.6-1
Version 5.4.6-2.1: VRF-lite support added to BGP for AR-series products

Version 5.4.7-2.1: BGP support added for IEx510, x550 series

Version 5.4.7-2.4: BGP support added for IE300 series

clear ip rip route

Overview Use this command to clear specific data from the RIP routing table.

Syntax `clear ip rip route <ip-dest-network/prefix-length>`
`clear ip rip route`
{static|connected|rip|ospf|bgp|invalid-routes|all}

Syntax (VRF-lite) `clear ip rip [vrf <vrf-name>] route`
`<ip-dest-network/prefix-length>`
`clear ip rip [vrf <vrf-name>] route`
{static|connected|rip|ospf|bgp|invalid-routes|all}

Parameter	Description
vrf	Apply this command to a VRF instance.
<vrf-name>	The name of the VRF instance.
<ip-dest-network/ prefix-length>	Removes entries which exactly match this destination address from RIP routing table. Enter the IP address and prefix length of the destination network.
static	Removes static entries from the RIP routing table.
connected	Removes entries for connected routes from the RIP routing table.
rip	Removes only RIP routes from the RIP routing table.
ospf	Removes only OSPF routes from the RIP routing table.
bgp	Removes only BGP routes from the RIP routing table.
invalid-routes	Removes routes with metric 16 immediately. Otherwise, these routes are not removed until RIP times out the route after 2 minutes.
all	Clears the entire RIP routing table.

Mode Privileged Exec

Usage notes Using this command with the **all** parameter clears the RIP table of all the routes.

Examples To clear the route 10.0.0.0/8 from the RIP routing table, use the following command:

```
awplus# clear ip rip route 10.0.0.0/8
```

Examples (VRF-lite) To clear RIP routes associated with the VRF instance 'red' for OSPF routes, use the following command:

```
awplus# clear ip rip vrf red route ospf
```

To clear the route 10.0.0.0/8 from the RIP routing table for the VRF instance 'red', use the following command:

```
awplus# clear ip rip vrf red route 10.0.0.0/8
```

**Command
changes**

Version 5.4.6-2.1: VRF-lite support added.

crypto key pubkey-chain knownhosts

Overview This command adds a public key of the specified SSH server to the known host database on your device. The SSH client on your device uses this public key to verify the remote SSH server.

The key is retrieved from the server. Before adding a key to this database, check that the key sent to you is correct.

If the server's key changes, or if your SSH client does not have the public key of the remote SSH server, then your SSH client will inform you that the public key of the server is unknown or altered.

The **no** variant of this command deletes the public key of the specified SSH server from the known host database on your device.

Syntax `crypto key pubkey-chain knownhosts [ip|ipv6] <hostname> [ecdsa|rsa]`
`no crypto key pubkey-chain knownhosts <1-65535>`

Syntax (VRF-lite) `crypto key pubkey-chain knownhosts [vrf <vrf-name>] [ip|ipv6] <hostname> [ecdsa|rsa]`
`no crypto key pubkey-chain knownhosts [vrf <vrf-name>] <1-65535>`

Parameter	Description
vrf	Apply this command to the specified VRF instance.
<vrf-name>	The VRF instance name
ip	Keyword used prior to specifying an IPv4 address
ipv6	Keyword used prior to specifying an IPv6 address
<hostname>	IPv4/IPv6 address or hostname of a remote server in the format a.b.c.d for an IPv4 address, or in the format x:x::x:x for an IPv6 address.
ecdsa	Specify the ECDSA public key of the server to be added to the known host database.
rsa	Specify the RSA public key of the server to be added to the known host database.
<1-65535>	Specify a key identifier when removing a key using the no parameter.

Default If no cryptography algorithm is specified, then **rsa** is used as the default cryptography algorithm.

Mode Privilege Exec

Usage notes This command adds a public key of the specified SSH server to the known host database on the device. The key is retrieved from the server. The remote SSH server is verified by using this public key. The user is requested to check the key is correct before adding it to the database.

If the remote server's host key is changed, or if the device does not have the public key of the remote server, then SSH clients will inform the user that the public key of the server is altered or unknown.

Examples To add the RSA host key of the remote SSH host IPv4 address 192.0.2.11 to the known host database, use the command:

```
awplus# crypto key pubkey-chain knownhosts 192.0.2.11
```

To delete the second entry in the known host database, use the command:

```
awplus# no crypto key pubkey-chain knownhosts 2
```

Examples (VRF-lite) To add the RSA host key of the remote SSH host IPv4 address 192.0.2.11 in VRF 'red' to the known host database, use the command:

```
awplus# crypto key pubkey-chain knownhosts vrf red 192.0.2.11
```

To delete the second entry in the known host database in VRF 'red', use the command:

```
awplus# no crypto key pubkey-chain knownhosts vrf red 2
```

Validation Commands [show crypto key pubkey-chain knownhosts](#)

Command changes Version 5.4.6-2.1: VRF-lite support added.

default-metric (RIP)

Overview Use this command to specify the metrics to be assigned to redistributed RIP routes. Use the **no** variant of this command to reset the RIP metric back to its default (1).

Syntax `default-metric <metric>`
`no default-metric [<metric>]`

Parameter	Description
<metric>	<1-16> Specifies the value of the default metric.

Default By default, the RIP metric value is set to 1.

Mode RIP Router Configuration or RIP Router Address Family Configuration for a VRF instance.

Usage notes This command is used with the [redistribute \(RIP\)](#) command to make the routing protocol use the specified metric value for all redistributed routes, regardless of the original protocol that the route has been redistributed from.

Examples This example assigns the cost of 10 to the routes that are redistributed into RIP.

```
awplus# configure terminal
awplus(config)# router rip
awplus(config-router)# default-metric 10
awplus(config-router)# redistribute ospf
awplus(config-router)# redistribute connected
```

Example (VRF-lite) This example assigns the cost of 10 to the routes which are redistributed into RIP for the VRF instance blue.

```
awplus# configure terminal
awplus(config)# router rip
awplus(config-router)# address family ipv4 vrf blue
awplus(config-router-af)# default-metric 10
awplus(config-router-af)# redistribute ospf
awplus(config-router-af)# redistribute connected
```

Related commands [redistribute \(RIP\)](#)

Command changes Version 5.4.6-2.1: VRF-lite support added.

description (VRF)

Overview Use this command to add text that describes a specific VRF instance. Descriptions can be up to 80 characters long.

The **no** variant of this command removes the description of the selected VRF instance.

Syntax `description <descriptive-text>`
`no description`

Parameter	Description
<code><descriptive-text></code>	A string of up to 80 characters that describes the VRF instance.

Mode VRF Configuration

Example To add the description for a VRF instance named blue, use the following commands:

```
awplus# config terminal
awplus(config)# ip vrf blue
awplus(config-vrf)# description the text description of vrf
blue
```

Related commands [show ip vrf](#)

Command changes Version 5.4.6-2.1: VRF-lite support added.

distance (RIP)

Overview This command sets the administrative distance for RIP routes. Your device uses this value to select between two or more routes to the same destination obtained from two different routing protocols. The route with the smallest administrative distance value is added to the Forwarding Information Base (FIB). For more information, see the [Route Selection Feature Overview and Configuration Guide](#).

The **no** variant of this command sets the administrative distance for the RIP route to the default of 120.

Syntax `distance <1-255> [<ip-addr/prefix-length>]`
`no distance [<1-255>] [<ip-addr/prefix-length>]`

Parameter	Description
<1-255>	The administrative distance value you are setting for this RIP route.
<ip-addr/prefix-length>	The network IP address and prefix-length that you are changing the administrative distance for.

Mode RIP Router Configuration or RIP Router Address Family Configuration for a VRF instance.

Examples To set the administrative distance to 8 for the RIP routes within the 10.0.0.0/8 network, use the commands:

```
awplus# configure terminal
awplus(config)# router rip
awplus(config-router)# distance 8 10.0.0.0/8
```

To set the administrative distance to the default of 120 for the RIP routes within the 10.0.0.0/8 network, use the commands:

```
awplus# configure terminal
awplus(config)# router rip
awplus(config-router)# no distance 8 10.0.0.0/8
```

Example (VRF-lite) This example assigns a cost of 10 to the routes for the VRF instance blue, when redistributed into RIP.

```
awplus# configure terminal
awplus(config)# router rip
awplus(config-router)# address family ipv4 blue
awplus(config-router-af)# distance 10
```

Command changes Version 5.4.6-2.1: VRF-lite support added.

distribute-list (RIP)

Overview Use this command to filter incoming or outgoing route updates using the prefix-list.

When running VRF-lite, this command can be applied to a specific VRF instance.

Use the **no** variant of this command to disable this feature.

Syntax `distribute-list prefix <prefix-list> {in|out} [<interface>]`
`no distribute-list prefix <prefix-list> {in|out} [<interface>]`

Parameter	Description
prefix	Filter prefixes in routing updates.
<prefix-list>	Specifies the name of the IPv4 prefix-list to use.
in	Filter incoming routing updates.
out	Filter outgoing routing updates.
<interface>	The interface on which the filtering applies.

Default Disabled

Mode RIP Router Configuration or RIP Router Address Family Configuration for a VRF instance.

Usage notes Filter out incoming or outgoing route updates using a prefix-list. If you do not specify the name of the interface, the filter will be applied to all interfaces.

Examples To apply a prefix list called 'myfilter' to filter incoming routing updates on eth1, use the commands:

```
awplus# configure terminal
awplus(config)# router rip
awplus(config-router)# distribute-list prefix myfilter in eth1
```

Example (VRF-lite) This example applies the commands of the previous prefix-list example, but to a specific VRF named blue:

```
awplus# configure terminal
awplus(config)# router rip
awplus(config-router)# address-family ipv4 vrf blue
awplus(config-router-af)# distribute-list prefix myfilter in
vlan2
```

Command changes Version 5.4.6-2.1: VRF-lite support added.

export map

Overview This command associates a route map with a specific VRF instance. It provides a finer control over the routes that are exported out of a VRF instance by the **route-target** command. Note, however, that this command does not replace the need for a route-target export in the VRF configuration.

The **no** variant of this command disables the capability to export route map entries for a specified VRF instance.

Syntax `export map <route-map>`
`no export map`

Parameter	Description
<code><route-map></code>	The route-map name.

Mode VRF Configuration

Usage notes Use this command to export route-map entries in VRF configuration mode.

Example To export the route map named routemap2 for the VRF instance named blue, use the following commands:

```
awplus# config terminal
awplus(config)# ip vrf blue
awplus(config-vrf)# export map routemap2
```

Related commands [import map](#)

Command changes Version 5.4.6-2.1: VRF-lite support added.

fullupdate (RIP)

Overview Use this command to specify which routes RIP should advertise when performing a triggered update. By default, when a triggered update is sent, RIP will only advertise those routes that have changed since the last update. When **fullupdate** is configured, the device advertises the full RIP route table in outgoing triggered updates, including routes that have not changed. This enables faster convergence times, or allows inter-operation with legacy network equipment, but at the expense of larger update messages.

Use the **no** variant of this command to disable this feature.

Syntax fullupdate
no fullupdate

Default By default this feature is disabled.

Mode RIP Router Configuration or RIP Router Address Family Configuration for a VRF instance.

Usage (VRF-lite) If VRF-lite is configured, you can apply this command for either the global routing environment, or to a specific VRF instance.

Example To enable the fullupdate (RIP) function, use the commands:

```
awplus# configure terminal
awplus(config)# router rip
awplus(config-router)# fullupdate
```

Example (VRF-lite) To enable the full update (RIP) function on the VRF instance named 'blue', use the commands:

```
awplus# configure terminal
awplus(config)# router rip
awplus(config-router)# address-family ipv4 vrf blue
awplus(config-router-af)# fullupdate
```

Command changes Version 5.4.6-2.1: VRF-lite support added.

http client vrf

Overview Use this command to enable the use of a specific VRF for the command **copy http**. Use the **no** variant of this command to disable the configured VRF.

Syntax `http client vrf <vrf-name>`
`no http client vrf`

Parameter	Description
<code>vrf</code> <code><vrf-name></code>	Specify the VRF to use when copying a file using HTTP.

Default Global VRF.

Mode Privileged Exec

Examples To enable the use of VRF 'MyVRF', use the commands:

```
awplus# configure terminal
awplus(config)# http client vrf MyVRF
```

To remove a specified VRF and revert to the global VRF, use the commands:

```
awplus# configure terminal
awplus(config)# no http client vrf
```

Output Figure 32-1: Example output if the specified VRF does not exist:

```
"Invalid VRF instance MyVRF"
```

Related commands [copy \(filename\)](#)
[show http client](#)

Command changes Version 5.5.2-1.1: command added

http vrf

Overview Use this command to configure an HTTP server to be run within a specified VRF. Use the **no** variant of this command to remove a VRF configuration from the HTTP server.

Syntax `http vrf <vrf-name>`
`no http vrf`

Parameter	Description
<code>vrf</code>	Specify the VRF to use when running the HTTP server.
<code><vrf-name></code>	The name of the VRF instance.

Default By default the HTTP server uses the global VRF.

Mode Global Configuration

Examples To configure VRF 'MyVRF', use the commands:

```
awplus# configure terminal
awplus(config)# http vrf MyVRF
```

To return the HTTP server to the global VRF, use the commands:

```
awplus# configure terminal
awplus(config)# no http vrf
```

Related commands [service http](#)
[show http](#)

Command changes Version 5.5.2-1.1: command added

fullupdate (RIP)

Overview Use this command to specify which routes RIP should advertise when performing a triggered update. By default, when a triggered update is sent, RIP will only advertise those routes that have changed since the last update. When **fullupdate** is configured, the device advertises the full RIP route table in outgoing triggered updates, including routes that have not changed. This enables faster convergence times, or allows inter-operation with legacy network equipment, but at the expense of larger update messages.

Use the **no** variant of this command to disable this feature.

Syntax fullupdate
no fullupdate

Default By default this feature is disabled.

Mode RIP Router Configuration or RIP Router Address Family Configuration for a VRF instance.

Usage (VRF-lite) If VRF-lite is configured, you can apply this command for either the global routing environment, or to a specific VRF instance.

Example To enable the fullupdate (RIP) function, use the commands:

```
awplus# configure terminal
awplus(config)# router rip
awplus(config-router)# fullupdate
```

Example (VRF-lite) To enable the full update (RIP) function on the VRF instance named 'blue', use the commands:

```
awplus# configure terminal
awplus(config)# router rip
awplus(config-router)# address-family ipv4 vrf blue
awplus(config-router-af)# fullupdate
```

Command changes Version 5.4.6-2.1: VRF-lite support added.

ip route static inter-vrf

Overview Applying this command enables static inter-VRF routing. Note that static inter-VRF routing must be enabled before you can use the **ip route** command to create a static inter-VRF route.

The **no** variant of this command disables static inter-VRF routing.

Syntax `ip route static inter-vrf`
`no ip route static inter-vrf`

Mode VRF Configuration

Default Static inter-VRF routing is enabled.

Example To enable static inter-VRF routing, use the following commands:

```
awplus# config terminal
awplus(config)# ip route static inter-vrf
```

Related commands [ip route](#)
[show ip route](#)

Command changes Version 5.4.6-2.1: VRF-lite support added.

import map

Overview The import map command associates a route map with a specific VRF instance. The import map command does not replace the need for a route-target import in the VRF configuration. It provides a finer control over the routes imported into a VRF instance by the **route-target** command.

The **no** variant of this command disables the capability to import route map entries for a specified VRF instance.

Syntax `import map <route-map>`
`no import map`

Parameter	Description
<code><route-map></code>	The route-map name.

Mode VRF Configuration

Usage notes Use this command to import route-map entries into the specified VRF instance.

Example To import the route map named `routemap2` for the VRF instance named `blue`, use the following commands:

```
awplus# config terminal
awplus(config)# ip vrf blue
awplus(config-vrf)# import map routemap2
```

Related commands [export map](#)

Command changes Version 5.4.6-2.1: VRF-lite support added.

ip route vrf

Overview This command adds a static route to the Routing Information Base (RIB). If this route is the best route for the destination, then your device adds it to the Forwarding Information Base (FIB). Your device uses the FIB to advertise routes to neighbors and forward packets.

When using VRF (Virtual Routing and Forwarding), you can use this command to configure a static inter-VRF route to a destination network that is reachable by a remote gateway located in a different VRF instance. Note that to apply the command in this way, the `ip route static inter-vrf` command must be in enabled (its default condition). For more information about VRF, see the [VRF Feature Overview and Configuration Guide](#) and the [VRF-lite Commands](#) chapter.

The **no** variant of this command removes the static route from the RIB and FIB.

Syntax

```
ip route [vrf <vrf-name>] <subnet&mask>
{<gateway-ip>|<interface>} [<distance>] [weight <1-255>]
[description <description>]

no ip route [vrf <vrf-name>] <subnet&mask>
{<gateway-ip>|<interface>} [<distance>] [weight <1-255>]
```

Parameter	Description
<subnet&mask>	The IPv4 address of the destination subnet defined using either a prefix length or a separate mask specified in one of the following formats: <ul style="list-style-type: none"> The IPv4 subnet address in dotted decimal notation followed by the subnet mask, also in dotted decimal notation. The IPv4 subnet address in dotted decimal notation, followed by a forward slash, then the prefix length.
<gateway-ip>	The IPv4 address of the gateway device.
<interface>	The interface that connects your device to the network. Enter the name of the VLAN or its VID. You can also enter 'null' as an interface. Specify a 'null' interface to add a null or blackhole route to the switch. The gateway IP address or the interface is required if VRF-lite is not configured. If VRF-lite is configured: When adding a static intra-VRF route, you must specify either the gateway IP address or the interface. When adding a static inter-VRF route, you must specify both the gateway IP address and the interface.
<distance>	The administrative distance for the static route in the range 1 to 255. Static routes by default have an administrative distance of 1, which gives them the highest priority possible.
vrf	Applies the command to the specified VRF instance.
<vrf-name>	The name of the VRF instance to enter IPv4 Address-Family mode for.

Parameter	Description
<code>weight <1-255></code>	Weight is used for the Weighted Lottery Load Balancing mode. See the Usage notes section for more information.
<code>description <description></code>	A description to record the route's purpose. It can be up to 80 printable ASCII characters long, including spaces. The description does not affect routing or forwarding decisions made by the device. To see the description, use the command show running-configuration .

Mode Global Configuration

Default The default administrative distance for a static route is 1.

Usage notes You can use administrative distance to determine which routes take priority over other routes.

Specify a 'Null' interface to add a null or blackhole route to the switch. A null or blackhole route is a routing table entry that does not forward packets, so any packets sent to it are dropped.

Versions of AlliedWare Plus earlier than 5.5.1-2.1 do not support descriptions on static routes, so a start-up configuration that contains descriptions will be rejected by these older versions. If you add descriptions, be careful if you downgrade to an older AlliedWare Plus version.

The **weight** parameter lets you assign a weight to the interface. AlliedWare Plus distributes the work load based on the number of sessions that are connected through the interfaces. It uses the weight that you assign to each interface to calculate a percentage of the total sessions that are allowed to connect through each interface. It then distributes the number of sessions between the interfaces accordingly.

Examples To create a static route from source VRF instance red, to the subnet 192.168.50.0/24 with a next hop of 192.168.20.6, use the following commands:

```
awplus# configure terminal
awplus(config)# ip route vrf red 192.168.50.0/24 192.168.20.6
```

To remove a static route from source VRF red, to the subnet 192.168.50.0/24 with a next hop of 192.168.20.6, use the following commands:

```
awplus# configure terminal
awplus(config)# no ip route vrf red 192.168.50.0/24
192.168.20.6
```

To create a static route from source VRF red, to the subnet 192.168.50.0/24 with a next hop of 192.168.20.6 via vlan10, use the following commands:

```
awplus# configure terminal
awplus(config)# ip route vrf red 192.168.50.0/24 192.168.20.6
vlan10
```

To create a static route from source VRF instance red, to the subnet 192.168.50.0/24 with a next hop of 192.168.20.6, and a weight of 7, use the following commands:

```
awplus# configure terminal
awplus(config)# ip route vrf red 192.168.50.0/24 192.168.20.6
weight 7
```

To give a route a description of 'test' when creating it, use the commands:

```
awplus# configure terminal
awplus(config)# ip route vrf red 192.168.50.0/24 192.168.20.6
description test
```

To remove the description from a route, re-enter the route without specifying the **description** parameter:

```
awplus# configure terminal
awplus(config)# ip route vrf red 192.168.50.0/24 192.168.20.6
```

**Related
commands**

[ip route](#)
[show ip route](#)
[show ip route database](#)

**Command
changes**

Version 5.5.2-1.1: **fall-over bfd** and **profile** parameters added for the SBx81CFC960, SBx908 GEN2, x950, x930, and x530 series.

Version 5.5.1-2.1: **weight** and **description** parameters added.

ip tftp vrf

Overview Use this command to specify a VRF to use when copying a file via TFTP.
Use the **no** variant of this command to remove the VRF from the configuration and set it back to the default VRF.

Syntax `ip tftp vrf <vrf-name>`
`no ip tftp vrf`

Parameter	Description
<code>vrf</code> <code><vrf-name></code>	Specify the VRF to use when copying a file using TFTP.

Default Global VRF

Mode Global Configuration

Example To configure a VRF called 'red' to use when copying a file via TFTP, use the commands:

```
awplus# configure terminal
awplus(config)# ip tftp vrf red
```

Related commands [copy \(filename\)](#)

Command changes Version 5.5.2-1.1: command added

ip vrf

Overview This command creates a VRF instance and specifies its unique name. You can also optionally specify a VRF ID. If you do not specify the VRF ID, a unique ID will automatically be created and assigned to the VRF instance.

The **no** variant of this command removes a selected VRF instance. All interfaces previously belonging to the removed instance are then returned to the global routing and forwarding environment.

Syntax `ip vrf <vrf-name> [<vrf-inst-id>]`
`no ip vrf <vrf-name> [<vrf-inst-id>]`

Parameter	Description
<code><vrf-name></code>	The name of the VRF instance.
<code><vrf-inst-id></code>	The ID of the VRF instance, a number in the range 1 to 8.

Mode Global Configuration

Default Static inter-VRF routing is enabled

Example To create a VRF instance named `vrf blue` and assign it the ID number `2`, use the following commands:

```
awplus# config terminal
awplus(config)# ip vrf blue 2
```

Command changes Version 5.4.6-2.1: On AR Series devices: VRF-lite support added
Version 5.5.0-0.1: On SBx908 GEN2 and x950 Series devices: **vrf-inst-id** parameter range increased to 600.

log host

Overview This command configures the device to send log messages to a remote syslog server via UDP port 514. The IP address of the remote server must be specified. By default no filters are defined for remote syslog servers. Filters must be defined before messages will be sent.

Use the **no** variant of this command to stop sending log messages to the remote syslog server.

Syntax `log host <ipv4-addr> [secure]`
`log host <ipv6-addr>`
`no log host <ipv4-addr>|<ipv6-addr>`

Syntax (VRF-lite) `log host <ipv4-addr> [vrf <vrf-name>] [secure]`
`log host <ipv6-addr> [vrf <vrf-name>]`
`no log host <ipv4-addr>|<ipv6-addr> [vrf <vrf-name>]`

Parameter	Description
<code><ipv4-addr></code>	Specify the source IPv4 address, in dotted decimal notation (A.B.C.D).
<code><ipv6-addr></code>	Specify the source IPv6 address, in X:X::X:X notation.
<code>vrf</code> <code><vrf-name></code>	The name of a VRF instance. Use this to specify the VRF that the remote syslog server (host) is accessible by. Hosts are uniquely identified by their address and VRF, so multiple hosts can have the same address as long as the VRF is different. The default is the global VRF.
<code>secure</code>	Optional value to create a secure log destination. This option is only valid for IPv4 hosts.

Mode Global Configuration

Usage notes Use the optional **secure** parameter to configure a secure IPv4 syslog host. For secure hosts, syslog over TLS is used to encrypt the logs. The certificate received from the remote log server must have an issuer chain that terminates with the root CA certificate for any of the trustpoints that are associated with the application.

The remote server may also request that a certificate is transmitted from the local device. In this situation the first trustpoint added to the syslog application will be transmitted to the remote server.

For detailed information about securing syslog, see the [PKI Feature Overview_and Configuration_Guide](#).

Examples To configure the device to send log messages to a remote secure syslog server with IP address 10.32.16.99, use the following commands:

```
awplus# configure terminal
awplus(config)# log host 10.32.16.99 secure
```

To stop the device from sending log messages to the remote syslog server with IP address 10.32.16.99, use the following commands:

```
awplus# configure terminal
awplus(config)# no log host 10.32.16.99
```

Example (VRF-lite) To configure the device to send log messages to a remote syslog server that is accessible via VRF 'red', use the following commands:

```
awplus# configure terminal
awplus(config)# log host 10.32.16.99 vrf red
```

Related commands

default log host
log host (filter)
log host exclude
log host source
log host startup-delay
log host time
log trustpoint
show log config

Command changes

Version 5.5.2-1.1: **vrf** parameter added for products that support VRF

log host exclude

Overview Use this command to prevent specified log messages from being sent to the remote syslog server, when `log host` is enabled. You can exclude messages on the basis of:

- the priority/severity of the message
- the program that generated the message
- the logging facility used
- a sub-string within the message, or
- a combination of some or all of these.

Use the **no** variant of this command to stop excluding the specified messages.

Syntax

```
log host {<hostname>|<ipv4-addr>|<ipv6-addr>} exclude [level <level>] [program <program-name>] [facility <facility>] [msgtext <text-string>]
no log host {<hostname>|<ipv4-addr>|<ipv6-addr>} exclude [level <level>] [program <program-name>] [facility <facility>] [msgtext <text-string>]
```

Syntax (VRF-lite)

```
log host {<hostname>|<ipv4-addr>|<ipv6-addr>} [vrf <vrf-name>] exclude [level <level>] [program <program-name>] [facility <facility>] [msgtext <text-string>]
no log host {<hostname>|<ipv4-addr>|<ipv6-addr>} [vrf <vrf-name>] exclude [level <level>] [program <program-name>] [facility <facility>] [msgtext <text-string>]
```

Parameter	Description
<hostname>	The host name of a remote syslog server.
<ipv4-addr>	The IPv4 address of a remote syslog server, in A.B.C.D format.
<ipv6-addr>	The IPv6 address of a remote syslog server, in X:X::X:X format.
vrf <vrf-name>	The name of a VRF instance. Use this if the syslog server is inside a VRF. The default is the global VRF.
level	Exclude messages of the specified severity level.
<level>	The severity level to exclude. The level can be specified as one of the following numbers or level names, where 0 is the highest severity and 7 is the lowest severity:
0 emergencies	System is unusable
1 alerts	Action must be taken immediately
2 critical	Critical conditions
3 errors	Error conditions
4 warnings	Warning conditions

Parameter	Description
	5 notices Normal, but significant, conditions
	6 informational Informational messages
	7 debugging Debug-level messages
program	Exclude messages from a specified program.
<program-name>	The name of a program. You can enter either one of the following predefined program names (depending on your device model), or another program name that you find in the log output. The pre-defined names are not case sensitive but other program names from the log output are.
	rip Routing Information Protocol (RIP)
	ripng Routing Information Protocol - next generation (RIPng)
	ospf Open Shortest Path First (OSPF)
	ospfv3 Open Shortest Path First (OSPF) version 3 (OSPFv3)
	bgp Border Gateway Protocol (BGP)
	rsvp Resource Reservation Protocol (RSVP)
	pim-dm Protocol Independent Multicast - Dense Mode (PIM-DM)
	pim-sm Protocol Independent Multicast - Sparse Mode (PIM-SM)
	pim-smv6 PIM-SM version 6 (PIM-SMv6)
	dot1x IEEE 802.1X Port-Based Access Control
	lacp Link Aggregation Control Protocol (LACP)
	stp Spanning Tree Protocol (STP)
	rstp Rapid Spanning Tree Protocol (RSTP)
	mstp Multiple Spanning Tree Protocol (MSTP)
	imi Integrated Management Interface (IMI)
	imish Integrated Management Interface Shell (IMISH)
	epsr Ethernet Protection Switched Rings (EPSR)
	irdp ICMP Router Discovery Protocol (IRDP)
	rmon Remote Monitoring
	loopprot Loop Protection
	poep Power-inline (Power over Ethernet)
	dhcpsn DHCP snooping (DHCP SN)
facility	Exclude messages from a syslog facility.
<facility>	Specify one of the following syslog facilities to exclude messages from:
	kern Kernel messages
	user Random user-level messages
	mail Mail system

Parameter	Description
daemon	System daemons
auth	Security/authorization messages
syslog	Messages generated internally by syslogd
lpr	Line printer subsystem
news	Network news subsystem
uucp	UUCP subsystem
cron	Clock daemon
authpriv	Security/authorization messages (private)
ftp	FTP daemon
msgtext	Exclude messages containing a certain text string.
<text-string>	A text string to match (maximum 128 characters). This is case sensitive, and must be the last text on the command line.

Default No log messages are excluded

Mode Global configuration

Example To exclude messages that contain the string 'example of irrelevant message' being sent to the remote syslog server 10.10.10.100, use the following commands:

```
awplus# configure terminal
awplus(config)# log host 10.10.10.100 exclude msgtext example
of irrelevant message
```

Example (VRF-lite) To exclude messages that contain the string 'example of irrelevant message' being sent to the remote syslog server 10.10.10.100, within VRF 'red', use the following commands:

```
awplus# configure terminal
awplus(config)# log host 10.10.10.100 vrf red exclude msgtext
example of irrelevant message
```

Related commands

- [default log host](#)
- [log host](#)
- [log host \(filter\)](#)
- [log host source](#)
- [log host time](#)
- [show log config](#)

Command changes Version 5.2.2-1.1: **vrf** parameter added for products that support VRF

log host (filter)

Overview This command creates a filter to select messages to be sent to a remote syslog server. Selection can be based on the priority/severity of the message, the program that generated the message, the logging facility used, a substring within the message or a combination of some or all of these.

The **no** variant of this command configures the device to no longer send log messages to a remote syslog server. The IP address of the syslog server must be specified. All configuration relating to this log target will be removed.

Syntax `log host <ip-addr> [level <level>] [program <program-name>] [facility <facility>] [msgtext <text-string>]`
`no log host <ip-addr> [level <level>] [program <program-name>] [facility <facility>] [msgtext <text-string>]`

Syntax (VRF-lite) `log host <ip-addr> [vrf <vrf-name>] [level <level>] [program <program-name>] [facility <facility>] [msgtext <text-string>]`
`no log host <ip-addr> [vrf <vrf-name>] [level <level>] [program <program-name>] [facility <facility>] [msgtext <text-string>]`

Parameter	Description
<ip-addr>	The IP address of a remote syslog server.
vrf <vrf-name>	The name of a VRF instance. Use this if the syslog server is inside a VRF. The default is the global VRF.
level	Filter messages by severity level.
<level>	The minimum severity of message to send. The level can be specified as one of the following numbers or level names, where 0 is the highest severity and 7 is the lowest severity:
0 emergencies	System is unusable
1 alerts	Action must be taken immediately
2 critical	Critical conditions
3 errors	Error conditions
4 warnings	Warning conditions
5 notices	Normal, but significant, conditions
6 informational	Informational messages
7 debugging	Debug-level messages
program	Filter messages by program. Include messages from a specified program.
<program-name>	The name of a program to log messages from. You can enter either one of the following predefined program names (depending on your device model), or another program name that you find in the log output. The pre-defined names are not case sensitive but other program names from the log output are.
rip	Routing Information Protocol (RIP)

Parameter	Description
ripng	Routing Information Protocol - next generation (RIPng)
ospf	Open Shortest Path First (OSPF)
ospfv3	Open Shortest Path First (OSPF) version 3 (OSPFv3)
bgp	Border Gateway Protocol (BGP)
rsvp	Resource Reservation Protocol (RSVP)
pim-dm	Protocol Independent Multicast - Dense Mode (PIM-DM)
pim-sm	Protocol Independent Multicast - Sparse Mode (PIM-SM)
pim-smv6	PIM-SM version 6 (PIM-SMv6)
dot1x	IEEE 802.1X Port-Based Access Control
lacp	Link Aggregation Control Protocol (LACP)
stp	Spanning Tree Protocol (STP)
rstp	Rapid Spanning Tree Protocol (RSTP)
mstp	Multiple Spanning Tree Protocol (MSTP)
imi	Integrated Management Interface (IMI)
imish	Integrated Management Interface Shell (IMISH)
epsr	Ethernet Protection Switched Rings (EPSR)
irdp	ICMP Router Discovery Protocol (IRDP)
rmon	Remote Monitoring
loopprot	Loop Protection
poe	Power-inline (Power over Ethernet)
dhcpsn	DHCP snooping (DHCP SN)
facility	Filter messages by syslog facility.
<facility>	Specify one of the following syslog facilities to include messages from:
kern	Kernel messages
user	Random user-level messages
mail	Mail system
daemon	System daemons
auth	Security/authorization messages
syslog	Messages generated internally by syslogd
lpr	Line printer subsystem
news	Network news subsystem
uucp	UUCP subsystem
cron	Clock daemon
authpriv	Security/authorization messages (private)

Parameter	Description
	ftp FTP daemon
msgtext	Select messages containing a certain text string.
<text-string>	A text string to match (maximum 128 characters). This is case sensitive, and must be the last text on the command line.

Mode Global Configuration

Examples To create a filter to send all messages containing the text "Bridging initialization", to a remote syslog server with IP address 10.32.16.21, use the following commands:

```
awplus# configure terminal
awplus(config)# log host 10.32.16.21 msgtext "Bridging
initialization"
```

To create a filter to send messages with a severity level of **informational** and above to the syslog server with IP address 10.32.16.21, use the following commands:

```
awplus# configure terminal
awplus(config)# log host 10.32.16.21 level informational
```

To remove a filter that sends all messages containing the text "Bridging initialization", to a remote syslog server with IP address 10.32.16.21, use the following commands:

```
awplus# configure terminal
awplus(config)# no log host 10.32.16.21 msgtext "Bridging
initialization"
```

To remove a filter that sends messages with a severity level of **informational** and above to the syslog server with IP address 10.32.16.21, use the following commands:

```
awplusawpluls# configure terminal
awplus(config)# no log host 10.32.16.21 level informational
```

Example (VRF-lite) To create a filter to send messages with a severity level of **informational** and above to the syslog server with IP address 10.32.16.21, when that server is in VRF 'red', use the following commands:

```
awplus# configure terminal
awplus(config)# log host 10.32.16.21 vrf red level
informational
```

Related commands

- [default log host](#)
- [log host](#)
- [log host exclude](#)
- [log host source](#)

log host time

show log config

**Command
changes**

Version 5.5.2-1.1: **vrf** parameter added for products that support VRF

log host time

Overview This command configures the time used in messages sent to a remote syslog server. If the syslog server is in a different time zone to your device then the time offset can be configured using either the **utc-offset** parameter option keyword or the **local-offset** parameter option keyword, where **utc-offset** is the time difference from UTC (Universal Time, Coordinated) and **local-offset** is the difference from local time.

Syntax `log host {<hostname>|<ipv4-addr>|<ipv6-addr>} time {local|local-offset|utc-offset {plus|minus} <0-24>}`

Syntax (VRF-lite) `log host {<ipv4-addr>|<ipv6-addr>} [vrf <vrf-name>] time {local|local-offset|utc-offset {plus|minus} <0-24>}`

Parameter	Description
<hostname>	The host name of a remote syslog server.
<ipv4-addr>	The IPv4 address of a remote syslog server, in A.B.C.D format.
<ipv6-addr>	The IPv6 address of a remote syslog server, in X:X::X:X format.
<email-address>	The email address to send log messages to
vrf <vrf-name>	The name of a VRF instance. Use this if the syslog server is inside a VRF. The default is the global VRF.
time	Specify the time difference between the email recipient and the device you are configuring.
local	The device is in the same time zone as the email recipient
local-offset	The device is in a different time zone to the email recipient. Use the plus or minus keywords and specify the difference (offset) from local time of the device to the email recipient in hours.
utc-offset	The device is in a different time zone to the email recipient. Use the plus or minus keywords and specify the difference (offset) from UTC time of the device to the email recipient in hours.
plus	Negative offset (difference) from the device to the syslog server.
minus	Positive offset (difference) from the device to the syslog server.
<0-24>	World Time zone offset in hours

Default The default is **local** time.

Mode Global Configuration

Usage notes Use the **local** option if the remote syslog server is in the same time zone as the device. Messages will display the time as on the local device when the message was generated.

Use the **offset** option if the email recipient is in a different time zone to this device. Specify the time offset of the remote syslog server in hours. Messages will display the time they were generated on this device but converted to the time zone of the remote syslog server.

Examples To send messages to the remote syslog server with the IP address 10.32.16.21 in the same time zone as the device's local time zone, use the following commands:

```
awplus# configure terminal
awplus(config)# log host 10.32.16.21 time local 0
```

To send messages to the remote syslog server with the IP address 10.32.16.12 with the time information converted to the time zone of the remote syslog server, which is 3 hours ahead of the device's local time zone, use the following commands:

```
awplus# configure terminal
awplus(config)# log host 10.32.16.12 time local-offset plus 3
```

To send messages to the remote syslog server with the IP address 10.32.16.02 with the time information converted to the time zone of the email recipient, which is 3 hours behind the device's UTC time zone, use the following commands:

```
awplus# configure terminal
awplus(config)# log host 10.32.16.02 time utc-offset minus 3
```

Example (VRF-lite) To send messages to the remote syslog server with the IP address 10.32.16.02 within the VRF 'red', in the same time zone as the switch's local time zone, use the following commands:

```
awplus# configure terminal
awplus(config)# log host 10.32.16.02 vrf red time utc-offset
minus 3
```

Related commands

- [default log host](#)
- [log host](#)
- [log host \(filter\)](#)
- [log host exclude](#)
- [log host source](#)
- [show log config](#)

Command changes Version 5.5.2-1.1: **vrf** parameter added for products that support VRF

ip vrf forwarding

Overview This command associates a VRF instance with an interface.
The **no** variant of this command disassociates the VRF instance from its interface.

Syntax `ip vrf forwarding <vrf-name>`
`no ip vrf <vrf-name>`

Parameter	Description
<vrf-name>	The name of the VRF instance.

Mode Interface Configuration

Default The default for an interface is the global routing table.

Examples For LAN interfaces, to associate the VRF instance named `blue` with the VLAN interface `vlan-admin`, use the following commands:

```
awplus# config terminal
awplus(config)# interface vlan-admin
awplus(config-if)# ip vrf forwarding blue
```

Related commands `show ip vrf`
`show ip vrf detail`

Command changes Version 5.4.6-2.1: VRF-lite support added.

max-fib-routes (VRF)

Overview This command now enables you to control the maximum number of FIB routes configured for a VRF instance. It operates by providing parameters that enable you to configure preset maximums and warning message thresholds.

NOTE: This command applies to a user-defined VRF instance; to set the max-fib-routes for the Global VRF instance use the [max-fib-routes](#) command. For static routes use the [max-static-routes](#) command for the Global VRF instance and the [max-static-routes \(VRF\)](#) command for a user-defined VRF instance.

Use the **no** variant of this command to set the maximum number of FIB routes to the default of 4294967294 FIB routes.

Syntax `max-fib-routes <1-4294967294> [<1-100>|warning-only]`
`no max-fib-routes`

Parameter	Description
<code>max-fib-routes</code>	The maximum number of routes that can be stored in Forwarding Information dataBase for either the Global VRF or a VRF instance.
<code><1-4294967294></code>	The allowable configurable range for setting the maximum number of FIB-routes.
<code><1-100></code>	This parameter enables you to optionally apply a percentage value. This percentage will be based on the maximum number of FIB routes you have specified. This will cause a warning message to appear when your routes reach your specified percentage value. Routes can continue to be added until your configured maximum value is reached.
<code>warning-only</code>	This parameter enables you to optionally apply a warning message. If you set this option a warning message will appear if your maximum configured value configured. Routes can continue to be added until your switch reaches either the maximum capacity value of 4294967294, or a practical system limit.

Mode VRF Configuration

Default Sets the maximum number of dynamic routes to 4294967294 and no warning threshold.

Examples To set the maximum number of dynamic routes to 2000 and warning threshold of 75% on VRF instance blue, use the commands:

```
awplus# config terminal
awplus(config)# ip vrf blue
awplus(config-vrf)# max-fib-routes 2000 75
```

Related commands [max-fib-routes](#)
[show ip route](#)

Command changes Version 5.4.6-2.1: VRF-lite support added.

max-static-routes (VRF)

Overview Use this command to set the maximum number of static routes (excluding FIB—Forwarding Information Base routes) for VRF instances. A limit of 1000 static routes can be assigned to each individual VRF instance. For example you can assign 800 static routes to the Global VRF, then also assign 600 static routes to VRF instance Blue, and a further 600 routes to VRF instance Green.

NOTE: This command applies to a user-defined VRF instance; to set the max-static-routes for the Global VRF instance use the [max-static-routes](#) command. For FIB routes use the [max-fib-routes](#) command for the Global VRF instance and the [max-fib-routes \(VRF\)](#) command for a user-defined VRF instance.

Use the **no** variant of this command to reset the maximum number of static routes to the default value of 1000.

Syntax `max-static-routes <1-1000>`
`no max-static-routes`

Default The default number of static routes is the maximum number of static routes (1000).

Mode VRF Configuration

Example To assign 200 static routes to VRF instance Blue, use the following commands:

```
awplus# configure terminal
awplus(config)# ip vrf blue
awplus(config-vrf)# max-static-routes 200
```

NOTE: Static routes are applied before adding routes to the RIB (Routing Information Base). Therefore, rejected static routes will not appear in the running config.

Related commands [max-fib-routes \(VRF\)](#)

Command changes Version 5.4.6-2.1: VRF-lite support added.

neighbor next-hop-self

Overview Use this command to configure the BGP or BGP4+ router as the next hop for a BGP or BGP4+ speaking neighbor or peer group.

Use the **no** variant of this command to disable this feature.

Syntax `neighbor <neighborid> next-hop-self`
`no neighbor <neighborid> next-hop-self`

Parameter	Description
<neighborid>	{ <ip-address> <ipv6-addr> <peer-group> }
<ip-address>	Specify the address of an IPv4 BGP neighbor, in dotted decimal notation A.B.C.D.
<ipv6-addr>	Specify the address of an IPv6 BGP4+ neighbor, entered in hexadecimal in the format X:X::X:X.
<peer-group>	Enter the name of an existing peer-group. For information on how to create peer groups, refer to the neighbor peer-group (add a neighbor) command, and neighbor route-map command. When this parameter is used with this command, the command applies on all peers in the specified group.

Mode [BGP] Router Configuration or IPv4 Address Family Configuration

Mode [BGP4+] IPv6 Address Family Configuration

Usage notes This command allows a BGP or BGP4+ router to change the next hop information that is sent to the iBGP peer. The next hop information is set to the IP address of the interface used to communicate with the neighbor.

This command can be run for a specific VRF instance.

Examples [BGP]

```
awplus# configure terminal
awplus(config)# router bgp 10
awplus(config-router)# neighbor 10.10.0.72 next-hop-self
awplus# configure terminal
awplus(config)# router bgp 10
awplus(config-router)# no neighbor 10.10.0.72 next-hop-self
awplus# configure terminal
awplus(config)# router bgp 10
awplus(config-router)# address-family ipv4
awplus(config-router)# neighbor 10.10.0.72 next-hop-self
awplus# configure terminal
awplus(config)# router bgp 10
awplus(config-router)# address-family ipv4
awplus(config-router)# no neighbor 10.10.0.72 next-hop-self
awplus# configure terminal
awplus(config)# router bgp 10
awplus(config-router)# neighbor group1 peer-group
awplus(config-router)# neighbor 10.10.10.72 remote-as 10
awplus(config-router)# neighbor 10.10.10.72 peer-group group1
awplus(config-router)# neighbor group1 next-hop-self
awplus# configure terminal
awplus(config)# router bgp 10
awplus(config-router)# no neighbor group1 next-hop-self
```

Examples
[BGP4+]

```
awplus# configure terminal
awplus(config)# router bgp 10
awplus(config-router)# address-family ipv6
awplus(config-router-af)# neighbor 2001:0db8:010d::1
next-hop-self
awplus# configure terminal
awplus(config)# router bgp 10
awplus(config-router)# address-family ipv6
awplus(config-router-af)# no neighbor 2001:0db8:010d::1
next-hop-self
awplus# configure terminal
awplus(config)# router bgp 10
awplus(config-router)# neighbor group1 peer-group
awplus(config-router)# neighbor 2001:0db8:010d::1 remote-as 10
awplus(config-router)# address-family ipv6
awplus(config-router-af)# neighbor 2001:0db8:010d::1
peer-group group1
awplus(config-router-af)# neighbor group1 next-hop-self
awplus# configure terminal
awplus(config)# router bgp 10
awplus(config-router)# address-family ipv6
awplus(config-router-af)# no neighbor group1 next-hop-self
```

Related
commands

[neighbor peer-group \(add a neighbor\)](#)
[neighbor route-map](#)

Command
changes

Added to AlliedWare Plus prior to 5.4.6-1
Version 5.4.7-2.1: BGP support added for IEx510, x550 series
Version 5.4.7-2.4: BGP support added for IE300 series

neighbor remote-as

Overview Use this command to configure an internal or external BGP or BGP4+ (iBGP or eBGP) peering relationship with another router.

Use the **no** variant of this command to remove a previously configured BGP or BGP4+ peering relationship.

Syntax `neighbor <neighborid> remote-as <as-number>`
`no neighbor <neighborid> remote-as <as-number>`

Syntax (VRF- lite) `neighbor <neighborid> remote-as <as-number> [global|vrf <vrf-name>]`
`no neighbor <neighborid> remote-as <as-number>`

Parameter	Description
<neighborid>	{<ip-address> ipv6-addr> <peer-group>}
<ip-address>	Specify the address of an IPv4 BGP neighbor, in dotted decimal notation A.B.C.D.
<ipv6-addr>	Specify the address of an IPv6 BGP4+ neighbor, entered in hexadecimal in the format X:X::X:X.
<peer-group>	Enter the name of an existing peer-group. For information on how to create peer groups, refer to the neighbor peer-group (add a neighbor) command, and neighbor route-map command. When this parameter is used with this command, the command applies on all peers in the specified group.
<as-number>	<1-4294967295> Neighbor's Autonomous System (AS) number.
global	Specify that the remote neighbor exists locally within the device, in the global routing domain
vrf	Specify that the remote neighbor exists locally within the device, in the specified VRF instance.
<vrf-name>	The name of the VRF instance.

Mode [BGP] Router Configuration or IPv4 Address Family Configuration

Mode [BGP4+] Router Configuration

Usage notes This command is used to configure iBGP and eBGP peering relationships with other BGP or BGP4+ neighbors. A peer-group support of this command is configured only after creating a specific peer-group. Use the **no** variant of this command to remove a previously configured BGP peering relationship.

The **vrf** and **global** parameters are used to create internal 'loopback' BGP connections within the device between two VRF instances. This is used to leak BGP routes between a named VRF instance and the global routing instance. This requires BGP neighbors to be configured in both the global routing instance and in the named VRF instance.

Examples [BGP] To configure a BGP peering relationship from the neighbor with the IPv4 address 10.10.0.73 with another router:

```
awplus# configure terminal
awplus(config)# router bgp 10
awplus(config-router)# neighbor 10.10.0.73 remote-as 10
```

To remove a configured BGP peering relationship from the neighbor with the IPv4 address 10.10.0.73 from another router:

```
awplus# configure terminal
awplus(config)# router bgp 10
awplus(config-router)# no neighbor 10.10.0.73 remote-as 10
```

To configure a BGP peering relationship from the neighbor with the peer group named group1 with another router:

```
awplus# configure terminal
awplus(config)# router bgp 10
awplus(config-router)# neighbor group1 peer-group
awplus(config-router)# neighbor 10.10.10.1 remote-as 10
awplus(config-router)# neighbor 10.10.10.1 peer-group group1
awplus(config-router)# neighbor group1 remote-as 10
```

To remove a configured BGP peering relationship from the neighbor with the peer group named group1 with another router:

```
awplus# configure terminal
awplus(config)# router bgp 10
awplus(config-router)# no neighbor group1 remote-as 10
```

Examples [BGP4+] To configure a BGP4+ peering relationship with another router:

```
awplus# configure terminal
awplus(config)# router bgp 11
awplus(config-router)# neighbor 2001:0db8:010d::1 remote-as 345
```

To remove a configured BGP4+ peering relationship from another router:

```
awplus# configure terminal
awplus(config)# router bgp 11
awplus(config-router)# no neighbor 2001:0db8:010d::1 remote-as 345
```

To configure a BGP4+ peering relationship from the neighbor with the peer group named group1 with another router:

```
awplus# configure terminal
awplus(config)# router bgp 10
awplus(config-router)# neighbor group1 peer-group
awplus(config-router)# neighbor 2001:0db8:010d::1 remote-as 10
awplus(config-router)# address-family ipv6
awplus(config-router-af)# neighbor 2001:0db8:010d::1
peer-group group1
awplus(config-router-af)# exit
awplus(config-router)# neighbor group1 remote-as 10
```

To remove a configured BGP4+ peering relationship from the neighbor with the peer group named group1 with another router:

```
awplus# configure terminal
awplus(config)# router bgp 10
awplus(config-router)# no neighbor group1 remote-as 10
```

**Command
changes**

Added to AlliedWare Plus prior to 5.4.6-1

Version 5.4.6-2.1: VRF-lite support added to BGP for AR-series products

Version 5.4.7-2.1: BGP support added for IEx510, x550 series

Version 5.4.7-2.4: BGP support added for IE300 series

neighbor password

Overview Use this command to enable MD5 authentication on a TCP connection between BGP and BGP4+ neighbors. No authentication is applied by default. To setup authentication for the session, you must first apply authentication on each connected peer for the session.

Use the **no** variant of this command to disable this function.

Syntax [BGP] `neighbor {<ip-address>|<peer-group-name>} password <password>`
`no neighbor {<ip-address>|<peer-group-name>} password`
`[<password>]`

Syntax [BGP4+] `neighbor {<ipv6-addr>|<peer-group-name>} password <password>`
`no neighbor {<ipv6-addr>|<peer-group-name>} password`
`[<password>]`

Parameter	Description
<code><ip-address></code>	Specifies the IP address of the BGP neighbor, in A.B.C.D format.
<code><ipv6-addr></code>	Specifies the IPv6 address of the BGP4+ neighbor, entered in hexadecimal in the format X:X::X:X.
<code><peer-group-name></code>	Name of an existing peer-group. When this parameter is used with this command, the command applies on all peers in the specified group.
<code><password></code>	An alphanumeric string of characters to be used as password.

Default No authentication is applied by default.

Mode [BGP] Router Configuration or IPv4 Address Family Configuration

Mode [BGP4+] Router Configuration

Usage notes When using the `<peer-group-name>` parameter with this command (to apply this command to all peers in the group), see the related commands [neighbor peer-group \(add a neighbor\)](#) and [neighbor route-map](#) for information about how to create peer groups first.

Examples [BGP] This example specifies the encryption type and the password 'manager' for the neighbor 10.10.10.1:

```
awplus# configure terminal
awplus(config)# router bgp 10
awplus(config-router)# neighbor 10.10.10.1 password manager
```

This example removes the password set for the neighbor 10.10.10.1:

```
awplus# configure terminal
awplus(config)# router bgp 10
awplus(config-router)# no neighbor 10.10.10.1 password
```

This example specifies the encryption type and the password 'manager' for the neighbor peer group named 'group1':

```
awplus# configure terminal
awplus(config)# router bgp 10
awplus(config-router)# neighbor group1 peer-group
awplus(config-router)# neighbor 10.10.10.1 remote-as 10
awplus(config-router)# neighbor 10.10.10.1 peer-group group1
awplus(config-router)# neighbor group1 password manager
```

This example removes the password set for the neighbor peer group named group1:

```
awplus# configure terminal
awplus(config)# router bgp 10
awplus(config-router)# no neighbor group1 password
```

**Examples
(VRF-lite)**

This example specifies the password ('manager') for the neighbor peer group named 'group1' for an IPv4 address-family VRF instance name 'red', and router bgp 10:

```
awplus# configure terminal
awplus(config)# router bgp 10
awplus(config-router)# address-family ipv4 vrf red
awplus(config-router-af)# neighbor 10.10.10.1 password manager
```

This example removes the password ('manager') for the neighbor peer group named 'group1' for an IPv4 address-family, VRF instance name 'red', and router bgp 10:

```
awplus# configure terminal
awplus(config)# router bgp 10
awplus(config-router)# address-family ipv4 vrf red
awplus(config-router-af)# no neighbor 10.10.10.1 password
manager
```

This example specifies the password ('manager') for the neighbor peer group named 'group1' for an IPv4 address-family, VRF instance name 'red', and router bgp 10:

```
awplus# configure terminal
awplus(config)# router bgp 10
awplus(config-router)# neighbor group1 peer-group
awplus(config-router)# neighbor 10.10.10.1 remote-as 10
awplus(config-router)# neighbor 10.10.10.1 peer-group group1
awplus(config-router)# address-family ipv4 vrf red
awplus(config-router-af)# neighbor group1 password manager
```

Examples [BGP4+] This example specifies the encryption type and the password 'manager' for the neighbor 2001:0db8:010d::1:

```
awplus# configure terminal
awplus(config)# router bgp 10
awplus(config-router)# neighbor password manager
2001:0db8:010d::1
```

This example removes the password set for the neighbor 2001:0db8:010d::1:

```
awplus# configure terminal
awplus(config)# router bgp 10
awplus(config-router)# no neighbor password 2001:0db8:010d::1
```

This example specifies the encryption type and the password 'manager' for the neighbor peer group named group1:

```
awplus# configure terminal
awplus(config)# router bgp 10
awplus(config-router)# neighbor group1 peer-group
awplus(config-router)# neighbor remote-as 102001:0db8:010d::1
awplus(config-router)# address-family ipv6
awplus(config-router-af)# neighbor peer-group group1
2001:0db8:010d::1
awplus(config-router-af)# exit
awplus(config-router)# neighbor group1 password manager
```

This example removes the password set for the neighbor peer group named 'group1':

```
awplus# configure terminal
awplus(config)# router bgp 10
awplus(config-router)# no neighbor group1 password
```

Related commands [neighbor peer-group \(add a neighbor\)](#)
[neighbor route-map](#)

**Command
changes**

Added to AlliedWare Plus prior to 5.4.6-1

Version 5.4.6-2.1: VRF-lite support added to BGP for AR-series products

Version 5.4.7-2.1: BGP support added for IEx510, x550 series

Version 5.4.7-2.4: BGP support added for IE300 series

network (RIP)

Overview Use this command to activate the transmission of RIP routing information on the defined network.

Use the **no** variant of this command to remove the specified network or interface as one that runs RIP.

Syntax `network {<network-address>[/<subnet-mask>] | <interface>}`
`no network {<network-address>[/<subnet-mask>] | <interface>}`

Parameter	Description
<code><network-address></code> <code>[/<subnet-mask>]</code>	Specifies the network address to run RIP. Entering a subnet mask (or prefix length) for the network address is optional. Where no mask is entered, the device will attempt to apply a mask that is appropriate to the class (A, B, or C) of the address entered, e.g. an IP address of 10.0.0.0 will have a prefix length of 8 applied to it.
<code><interface></code>	Specify an interface to run RIP.

Default Disabled

Mode RIP Router Configuration or RIP Router Address Family Configuration for a VRF instance.

Usage notes Use this command to specify networks, by IP address or interface, to which routing updates will be sent and received. The connected routes corresponding to the specified network will be automatically advertised in RIP updates. RIP updates will be sent and received within the specified network.

When running VRF-lite, this command can be applied to a VRF instance.

Example Use the following commands to activate RIP routing updates on network 172.16.20.0/24:

```
awplus# configure terminal
awplus(config)# router rip
awplus(config-router)# network 172.16.20.0/24
```

Example (VRF-lite) To activate RIP routing updates on vlan3 for VRF instance 'blue'.

```
awplus# configure terminal
awplus(config)# router rip
awplus(config-router)# address-family ipv4 vrf blue
awplus(config-router-af)# network vlan3
```

Related commands show ip rip
show running-config
clear ip rip route

Command changes Version 5.4.6-2.1: VRF-lite support added.

passive-interface (RIP)

Overview Use this command to block RIP broadcasts on the interface.
Use the **no** variant of this command to disable this function.

Syntax `passive-interface <interface>`
`no passive-interface <interface>`

Parameter	Description
<code><interface></code>	Specifies the interface name.

Default Disabled

Mode RIP Router Configuration or RIP Router Address Family Configuration for a VRF instance.

Example Use the following commands to block RIP broadcasts on eth1:

```
awplus# configure terminal
awplus(config)# router rip
awplus(config-router)# passive-interface eth1
```

Example (VRF-lite) To apply the example above to a specific VRF instance named 'green', use the following commands:

```
awplus# configure terminal
awplus(config)# router rip
awplus(config-router)# address-family ipv4 vrf green
awplus(config-router-af)# passive-interface eth1
```

Related commands [show ip rip](#)

Command changes Version 5.4.6-2.1: VRF-lite support added.

ping

Overview This command sends a query to another IPv4 host (send Echo Request messages).

Syntax ping [ip] <host> [broadcast] [df-bit {yes|no}] [interval <0-128>] [pattern <hex-data-pattern>] [repeat {<1-2147483647>|continuous}] [size <36-18024>] [source <ip-addr>] [timeout <1-65535>] [tos <0-255>]

Syntax (VRF-lite) ping [vrf <vrf-name>] [ip] <host> [broadcast] [df-bit {yes|no}] [interval <0-128>] [pattern <hex-data-pattern>] [repeat {<1-2147483647>|continuous}] [size <36-18024>] [source <ip-addr>] [timeout <1-65535>] [tos <0-255>]

Parameter	Description
<host>	The destination IP address or hostname.
broadcast	Allow pinging of a broadcast address.
df-bit	Enable or disable the do-not-fragment bit in the IP header.
interval <0-128>	Specify the time interval in seconds between sending ping packets. The default is 1. You can use decimal places to specify fractions of a second. For example, to ping every millisecond, set the interval to 0.001.
pattern <hex-data-pattern>	Specify the hex data pattern.
repeat	Specify the number of ping packets to send.
<1-2147483647>	Specify repeat count. The default is 5.
continuous	Continuous ping
size <36-18024>	The number of data bytes to send, excluding the 8 byte ICMP header. The default is 56 (64 ICMP data bytes).
source <ip-addr>	The IP address of a configured IP interface to use as the source in the IP header of the ping packet.
timeout <1-65535>	The time in seconds to wait for echo replies if the ARP entry is present, before reporting that no reply was received. If no ARP entry is present, it does not wait.
tos <0-255>	The value of the type of service in the IP header.
vrf	Apply the command to the specified VRF instance.
<vrf-name>	The name of the VRF instance.

Mode User Exec and Privileged Exec

Example To ping the IP address 10.10.0.5 use the following command:

```
awplus# ping 10.10.0.5
```

Example (VRF-lite) To ping the IP address 10.10.0.5 from VRF instance 'red', use the following command:

```
awplus# ping vrf red 10.10.0.5
```

NOTE: *Unless a cross-domain static or leaked route exists to the destination IP address, you must run this command from within the same routing domain as the address being pinged.*

Command changes Version 5.4.6-2.1: VRF-lite support added.

radius-server host

Overview Use this command to specify a remote RADIUS server host for authentication or accounting, and to set server-specific parameters. The parameters specified with this command override the corresponding global parameters for RADIUS servers. This command specifies the IP address or host name of the remote RADIUS server host and assigns authentication and accounting destination UDP port numbers.

This command adds the RADIUS server address and sets parameters to the RADIUS server. The RADIUS server is added to the running configuration after you issue this command. If parameters are not set using this command then common system settings are applied.

Use the **no** variant of this command to remove the specified server host as a RADIUS authentication and/or accounting server and set the destination port to the default RADIUS server port number (1812).

Syntax

```
radius-server host {<host-name>|<ip-address>} [acct-port <0-65535>] [auth-port <0-65535>] [key <key-string>] [retransmit <0-100>] [timeout <1-1000>]
no radius-server host {<host-name>|<ip-address>} [acct-port <0-65535>] [auth-port <0-65535>]
```

Syntax (VRF-lite)

```
radius-server host {<host-name>|<ip-address>} [acct-port <0-65535>] [auth-port <0-65535>] [key <key-string>] [retransmit <0-100>] [timeout <1-1000>] [vrf <vrf-name>]
no radius-server host {<host-name>|<ip-address>} [acct-port <0-65535>] [auth-port <0-65535>] [vrf <vrf-name>]
```

Parameter	Description
<host-name>	Server host name. The DNS name of the RADIUS server host.
<ip-address>	The IP address of the RADIUS server host.
acct-port	Accounting port. Specifies the UDP destination port for RADIUS accounting requests. If 0 is specified, the server is not used for accounting. The default UDP port for accounting is 1813.
<0-65535>	UDP port number. (Accounting port number is set to (accounting port number is set to 1813 by default) Specifies the UDP destination port for RADIUS accounting requests. If 0 is specified, the host is not used for accounting.
auth-port	Authentication port. Specifies the UDP destination port for RADIUS authentication requests. If 0 is specified, the server is not used for authentication. The default UDP port for authentication is 1812.
<0-65535>	UDP port number (authentication port number is set to 1812 by default). Specifies the UDP destination port for RADIUS authentication requests. If 0 is specified, the host is not used for authentication.

Parameter	Description
timeout	Specifies the amount of time to wait for a response from the server. If this parameter is not specified the global value configured by the radius-server timeout command is used.
<1-1000>	Time in seconds to wait for a server reply (timeout is set to 5 seconds by default). The time interval (in seconds to wait for the RADIUS server to reply before retransmitting a request or considering the server dead. This setting overrides the global value set by the radius-server timeout command. If no timeout value is specified for this server, the global value is used.
retransmit	Specifies the number of retries before skip to the next server. If this parameter is not specified the global value configured by the radius-server retransmit command is used.
<0-100>	Maximum number of retries (maximum number of retries is set to 3 by default). The maximum number of times to resend a RADIUS request to the server, if it does not respond within the timeout interval, before considering it dead and skipping to the next RADIUS server. This setting overrides the global setting of the radius-server retransmit command. If no retransmit value is specified, the global value is used.
key	Set shared secret key with RADIUS servers.
<key-string>	Shared key string applied. Specifies the shared secret authentication or encryption key for all RADIUS communications between this device and the RADIUS server. This key must match the encryption used on the RADIUS daemon. All leading spaces are ignored, but spaces within and at the end of the string are used. If spaces are used in the string, do not enclose the string in quotation marks unless the quotation marks themselves are part of the key. This setting overrides the global setting of the radius-server key command. If no key value is specified, the global value is used.
vrf <vrf-name>	The name of a VRF instance. Use this to specify the VRF that the RADIUS server is accessible by. Servers are uniquely identified by their address and VRF, so multiple servers can have the same address or host-name as long as the VRF is different. The default is the global VRF.

Default The RADIUS client address is not configured (null) by default. No RADIUS server is configured.

Mode Global Configuration

Usage Multiple **radius-server host** commands can be used to specify multiple hosts. The software searches for hosts in the order they are specified. If no host-specific timeout, retransmit, or key values are specified, the global values apply to that host. If there are multiple RADIUS servers for this client, use this command multiple times—once to specify each server.

If you specify a host without specifying the auth port or the acct port, it will by default be configured for both authentication and accounting, using the default

UDP ports. To set a host to be a RADIUS server for authentication requests only, set the **acct-port** parameter to 0; to set the host to be a RADIUS server for accounting requests only, set the **auth-port** parameter to 0.

A RADIUS server is identified by IP address, authentication port and accounting port. A single host can be configured multiple times with different authentication or accounting ports. All the RADIUS servers configured with this command are included in the predefined RADIUS server group **radius**, which may be used by AAA authentication, authorization and accounting commands. The client transmits (and retransmits, according to the **retransmit** and **timeout** parameters) RADIUS authentication or accounting requests to the servers in the order you specify them, until it gets a response.

Examples To add the RADIUS server 10.0.0.20, use the following commands:

```
awplus# configure terminal
awplus(config)# radius-server host 10.0.0.20
```

To set the secret key to 'mySecret' on the RADIUS server 10.0.0.20, use the following commands:

```
awplus# configure terminal
awplus(config)# radius-server host 10.0.0.20 key mySecret
```

To delete the RADIUS server 10.0.0.20, use the following commands:

```
awplus# configure terminal
awplus(config)# no radius-server host 10.0.0.20
```

To configure rad1.company.com for authentication only, use the following commands:

```
awplus# configure terminal
awplus(config)# radius-server host rad1.company.com acct-port 0
```

To remove the RADIUS server rad1.company.com configured for authentication only, use the following commands:

```
awplus# configure terminal
awplus(config)# no radius-server host rad1.company.com
acct-port 0
```

To configure rad2.company.com for accounting only, use the following commands:

```
awplus# configure terminal
awplus(config)# radius-server host rad2.company.com auth-port 0
```

To configure 192.168.1.1 with authentication port 1000, accounting port 1001 and retransmit count 5, use the following commands:

```
awplus# configure terminal
awplus(config)# radius-server host 192.168.1.1 auth-port 1000
acct-port 1001 retransmit 5
```

Examples (VRF-lite) To add the RADIUS server 10.0.0.20 in the VRF named 'red', use the following commands:

```
awplus# configure terminal
awplus(config)# radius-server host 10.0.0.20 vrf red
```

To set the secret key to 'mySecret' on the RADIUS server 10.0.0.20 in the VRF named 'red', use the following commands:

```
awplus# configure terminal
awplus(config)# radius-server host 10.0.0.20 key mySecret vrf red
```

Related commands

- aaa group server
- radius-server key
- radius-server retransmit
- radius-server timeout

Command changes

- Version 5.5.2-1.1: **vrf** parameter added for products that support VRF
- Version 5.4.9-2.1: **key-encrypted** parameter added

rd (route distinguisher)

Overview This command creates a Route Distinguisher (RD). The RD forms part of the route table creation process for a VRF instance and is implemented only when using BGP routing.

Syntax `rd {<ASN:n>|<ip-address:n>}`

CAUTION: This command does not have a “no” variant. To remove the RD requires deleting the VRF instance to which it is assigned. Therefore, it is important that you carefully enter the correct value for the RD.

Parameter	Description
<ASN:n>	The RD reference number. This is based on the formal RD format structure of ASN number:Ref number. The ASN value can be any number between 1 and 4294967295, and the value n can be any number between 1 and 65535.
<ip-address:n>	The RD reference number. This is based on the formal RD format structure of IP-address:Ref number. The IP-address must be in IPv4 format. The value n can be any number between 1 and 65535.

NOTE: The above table refers to an ASN or Autonomous System Number. If you have a formal ASN number assigned to your BGP network, you should enter this value. Alternatively; because the Route Distinguisher has limited functionality in VRF-lite, you can use an unofficial value for your ASN when configuring this particular command.

Mode VRF Configuration

Usage notes For the implementation of VRF-lite installed on your switch, this command has little practical functionality. However, the switch does check certain components of the RD that you enter. For this reason, the RD syntax must comply with the structural formats defined above, and each value that you assign to a VRF instance must be unique on the switch. Good networking practice is to use common values for the RD and RT within a VRF instance.

Default No default RD is configured.

Example To create an RD 100:2 that is associated with VRF “red” use the following commands:

```
awplus# config terminal
awplus(config)# ip vrf red
awplus(config-vrf)# rd 100:2
```

Related commands [show ip vrf](#)

redistribute (into BGP or BGP4+)

Overview Use this command to inject routes from one routing process into a BGP or BGP4+ routing table.

Use the **no** variant of this command to disable this function.

Syntax redistribute {ospf|rip|connected|static} [route-map
<route-map-entry-pointer>]

no redistribute {ospf|rip|connected|static} [route-map
<route-map-entry-pointer>]

Parameter	Description
connected	Specifies the redistribution of connected routes for both BGP and BGP4+.
ospf	Specifies the redistribution of OSPF information for BGP or OSPFv3 information for BGP4+.
rip	Specifies the redistribution of RIP information for BGP or RIPng information for BGP4+.
static	Specifies the redistribution of Static routes for both BGP and BGP4+.
route-map	Route map reference for both BGP and BGP4+.
<route-map-entry-pointer>	Pointer to route-map entries.

Mode [BGP] Router Configuration or IPv4 Address Family Configuration

Mode [BGP4+] Router Configuration or IPv6 Address Family Configuration

Usage notes Redistribution is used by routing protocols to advertise routes that are learned by some other means, such as by another routing protocol or by static routes. Since all internal routes are dumped into BGP, careful filtering is applied to make sure that only routes to be advertised reach the internet, not everything. This command allows redistribution by injecting prefixes from one routing protocol into another routing protocol.

Examples [BGP/ BGP+] The following example shows the configuration of a route-map named `rmap1`, which is then applied using the **redistribute route-map** command.

```
awplus# configure terminal
awplus(config)# route-map rmap1 permit 1
awplus(config-route-map)# match origin incomplete
awplus(config-route-map)# set metric 100
awplus(config-route-map)# exit
awplus(config)# router bgp 12
awplus(config-router)# redistribute ospf route-map rmap1
```

To apply the above example to a specific VRF instance named `blue`, use the following commands:

```
awplus(config)# router bgp 12
awplus(config-router)# address-family ipv4 vrf blue
awplus(config-router-af)# redistribute ospf route-map rmap1
```

The following example shows the configuration of a route-map named `rmap2`, which is then applied using the **redistribute route-map** command.

```
awplus# configure terminal
awplus(config)# route-map rmap2 permit 3
awplus(config-route-map)# match interface eth1
awplus(config-route-map)# set metric-type 1
awplus(config-route-map)# exit
awplus(config)# router ospf 100
awplus(config-router)# redistribute bgp route-map rmap2
```

Note that configuring a route-map and applying it with the **redistribute route-map** command allows you to filter which routes are distributed from another routing protocol (such as OSPF with BGP). A route-map can also set the metric, tag, and metric-type of the redistributed routes.

**Command
changes**

Added to AlliedWare Plus prior to 5.4.6-1

Version 5.4.6-2.1: VRF-lite support added to BGP for AR-series products

Version 5.4.7-2.1: BGP support added for IEx510, x550 series

Version 5.4.7-2.4: BGP support added for IE300 series

redistribute (OSPF)

Overview Use this command to redistribute routes from other routing protocols, static routes and connected routes into an OSPF routing table.

Use the **no** variant of this command to disable this function.

Syntax

```
redistribute {bgp|connected|rip|static} {metric  
<0-16777214>|metric-type {1|2}|route-map <name>|tag  
<0-4294967295>}  
  
no redistribute {bgp|connected|rip|static} {metric  
<0-16777214>|metric-type {1|2}|route-map <name>|tag  
<0-4294967295>}
```

Parameter	Description
bgp	Specifies that this applies to the redistribution of BGP routes.
connected	Specifies that this applies to the redistribution of connected routes.
rip	Specifies that this applies to the redistribution of RIP routes.
static	Specifies that this applies to the redistribution of static routes.
metric	Specifies the external metric.
metric-type	Specifies the external metric-type.
route-map	Specifies name of the route-map.
tag	Specifies the external route tag.

Default The default metric value for routes redistributed into OSPF is 20. The metric can also be defined using the [set metric](#) command for a route map. Note that a metric defined using the [set metric](#) command for a route map overrides a metric defined with this command.

Mode Router Configuration

Usage notes You use this command to inject routes, learned from other routing protocols, into the OSPF domain to generate AS-external-LSAs. If a route-map is configured by this command, then that route-map is used to control which routes are redistributed and can set metric and tag values on particular routes.

The metric, metric-type, and tag values specified on this command are applied to any redistributed routes that are not explicitly given a different metric, metric-type, or tag value by the route map.

See the [OSPF Feature Overview and Configuration Guide](#) for more information about metrics, and about behavior when configured in route maps.

Note that this command does not redistribute the default route. To redistribute the default route, use the [default-information originate](#) command.

Example The following example shows redistribution of BGP routes into OSPF routing table 100, with metric 12.

```
awplus# configure terminal
awplus(config)# router ospf 100
awplus(config-router)# redistribute bgp metric 12
```

The following example shows the configuration of a route-map named 'rmap2', which is then applied using the **redistribute route-map** command, so routes learned via a specified interface can be redistributed as type-1 external LSAs:

```
awplus# configure terminal
awplus(config)# route-map rmap2 permit 3
awplus(config-route-map)# match interface eth1
awplus(config-route-map)# set metric-type 1
awplus(config-route-map)# exit
awplus(config)# router ospf 100
awplus(config-router)# redistribute rip route-map rmap2
```

Note that configuring a route-map and applying it with the **redistribute route-map** command allows you to filter which routes are distributed from another routing protocol (such as RIP). A route-map can also set the metric, tag, and metric-type of the redistributed routes.

Related commands

- [match interface](#)
- [route-map](#)
- [show ip ospf database external](#)

redistribute (RIP)

Overview Use this command to redistribute information from other routing protocols into RIP.

When using VRF-lite, you can apply this command to a specific VRF instance.

Use the **no** variant of this command to disable the specified redistribution. The parameters **metric** and **route-map** may be used with the **no** variant, but have no effect.

Syntax

```
redistribute {connected|static|ospf|bgp} [metric <0-16>]
[routemap <routemap>]
no redistribute {connected|static|ospf|bgp} [metric] [routemap]
```

Parameter	Description
routemap	Optional. Specifies route-map that controls how routes are redistributed.
<routemap>	Optional. The name of the route map.
connected	Redistribute from connected routes.
static	Redistribute from static routes.
ospf	Redistribute from Open Shortest Path First (OSPF).
bgp	Redistribute from Border Gateway Protocol (BGP).
metric <0-16>	Optional. Sets the value of the metric that will be applied to routes redistributed into RIP from other protocols. If a value is not specified, and no value is specified using the default-metric (RIP) command, the default is one.

Default By default, the RIP metric value is set to 1.

Mode RIP Router Configuration or RIP Router Address Family Configuration for a VRF instance.

Example To apply the metric value 15 to static routes being redistributed into RIP, use the commands:

```
awplus# configure terminal
awplus(config)# router rip
awplus(config-router)# redistribute static metric 15
```

Example (VRF-lite) To apply the metric value 15 to static routes in address-family ipv4 VRF instance blue being redistributed into RIP, use the following commands:

```
awplus# configure terminal
awplus(config)# router rip
awplus(config-router)# address-family ipv4 vrf blue
awplus(config-router-af)# redistribute static metric 15
```

Related commands [default-metric \(RIP\)](#)

Command changes Version 5.4.6-2.1: VRF-lite support added.

route (RIP)

Overview Use this command to add a static RIP route.
Use the **no** variant of this command to remove a static RIP route.

Syntax `route <ip-addr/prefix-length>`
`no route <ip-addr/prefix-length>`

Parameter	Description
<code><ip-addr/prefix-length></code>	The IPv4 address and prefix length.

Default No static RIP route is added by default.

Mode RIP Router Configuration or RIP Router Address Family Configuration for a VRF instance.

Usage notes Use this command to add a static RIP route. After adding the RIP route, the route can be checked in the RIP routing table.

Example To create a static RIP route to IP subnet 192.168.1.0/24, use the following commands:

```
awplus# configure terminal
awplus(config)# router rip
awplus(config-router)# route 192.168.1.0/24
```

Example (VRF-lite) To create a static RIP route to IP subnet 192.168.1.0/24, for the VRF instance red, use the following commands

```
awplus# configure terminal
awplus(config)# router rip
awplus(config-router)# address-family ipv4 vrf red
awplus(config-router-af)# route 192.168.1.0/24
```

Related commands [show ip rip](#)
[clear ip rip route](#)

Command changes Version 5.4.6-2.1: VRF-lite support added.

route-target

Overview Use this command within a specific VRF instance, to create a route-target within the BGP extended communities path attribute field. This value can then be included in a list of import and export route target extended communities for the specified VRF instance. Learned routes that carry a specific route-target extended community are then imported into all VRFs configured with that extended community as an imported route-target.

The **no** variant of this command removes a route-target extended community for the VRF instance specified.

Syntax `route-target {import|export|both} {ASN:n|ip-address:n}`
`no route-target {import|export|both} {ASN:n|ip-address:n}`

Parameter	Description
<code>route-target</code>	Specifies a BGP extended community as a route-target.
<code>import</code>	Adds the route target to its import list.
<code>export</code>	Adds the route target to its export list.
<code>both</code>	Adds the route target to both the import and export lists.
<code><ASN:n></code>	The route target reference number. This uses the same structure that is defined for the RD. This being, ASN number:Ref number. The ASN value can be any number between 1 and 65535, and the value n can be any number between 1 and 4294967295.
<code><ip-address:n></code>	The route target reference number. This uses the same structure that is defined for the RD (Route Distinguisher). This being IP-address:Ref number. In practice, the IP-address can be an entry in IPv4 format, or an integer number between 1 and 4294967295. The value n can be any number between 1 and 65535.

Mode VRF Configuration

Default No route-target community attributes are associated with a VRF instance.

Usage notes In VRF systems that use MPLS, there is an close relationship between the Route Target (RT) and the Route Distinguisher (RD) values. For VRF-lite however, this relationship is only implicit in that they share the same format structure.

Example Use the following commands to create a route-target extended community for ASN value 200, and a Reference number of 3, within the VRF instance blue:

```
awplus# config terminal
awplus(config)# ip vrf blue
awplus(config-vrf)# route-target import 200:1
```

**Related
commands** [ip vrf](#)
[show ip vrf](#)

router ospf

Overview Use this command to enter Router Configuration mode to configure an OSPF routing process. You must specify the process ID with this command for multiple OSPF routing processes on the device.

Use the **no** variant of this command to terminate an OSPF routing process.

Use the **no** parameter with the **process-id** parameter, to terminate and delete a specific OSPF routing process. If no **process-id** is specified on the **no** variant of this command, then all OSPF routing processes are terminated, and all OSPF configuration is removed.

Syntax `router ospf [<process-id>]`
`no router ospf [<process-id>]`

Syntax (VRF-lite) `router ospf [<process-id>] [<vrf-instance>]`
`no router ospf [<process-id>]`

Parameter	Description
<code><process-id></code>	A positive number from 1 to 65535, that is used to define a routing process.
<code><vrf-instance></code>	The VRF instance to be associated with the OSPF routing process.

Default No routing process is defined by default.

Mode Global Configuration

Usage notes The process ID of OSPF is an optional parameter for the **no** variant of this command only. When removing all instances of OSPF, you do not need to specify each Process ID, but when removing particular instances of OSPF you must specify each Process ID to be removed.

When using VRF-lite, this command can be used to associate a process-id with a VRF instance that has been created using the [ip vrf](#) command.

Example To enter Router Configuration mode to configure an existing OSPF routing process 100, use the commands:

```
awplus# configure terminal
awplus(config)# router ospf 100
awplus(config-router)#
```

Example (VRF-lite) To enter Router Configuration mode to configure an existing OSPF routing process 100 for VRF instance `red`, use the commands:

```
awplus# configure terminal
awplus(config)# router ospf 100 red
awplus(config-router)#
```

Command changes Version 5.4.6-2.1: VRF-lite support added.

router-id (VRF)

Overview Use this command to specify a router identifier (in IP address format). When using VRF-Lite, the router-id is configured for the specified VRF instance.

Use the **no** variant of this command to force OSPF to use the previous OSPF router-id behavior.

Syntax `router-id <ip-address>`
`no router-id`

Parameter	Description
<code><ip-address></code>	Specifies the router ID in IPv4 address format.

Mode Router Configuration

Usage notes Configure each router with a unique router-id. In an OSPF router process that has active neighbors, a new router-id is used at the next reload or when you restart OSPF manually.

Example The following example shows a fixed router ID 10.10.10.60 for the VRF instance red:

```
awplus# configure terminal
awplus(config)# ip vrf red
awplus(config-router)# router-id 10.10.10.60
```

Related commands [show ip ospf](#)
[show ip vrf](#)

show arp

Overview Use this command to display entries in the ARP routing and forwarding table—the ARP cache contains mappings of IP addresses to physical addresses for hosts. To have a dynamic entry in the ARP cache, a host must have used the ARP protocol to access another host.

For information on filtering and saving command output, see the [“Getting Started with AlliedWare Plus” Feature Overview and Configuration Guide](#).

Syntax show arp

Syntax (VRF-lite) show arp [global|vrf <vrf-name>]

Parameter	Description
global	When VRF-lite is configured, apply this command to the global routing and forwarding table
vrf	Apply this command to the specified VRF instance.
<vrf-name>	The VRF instance name

Mode User Exec and Privileged Exec

Usage notes Running this command with no additional parameters will display all entries in the ARP routing and forwarding table.

With VRF-lite configured, and no additional parameters entered, the command output displays all entries, listed by their VRF instance. By adding either a specific VRF instance or global parameter entry, you can selectively list ARP entries by their membership of a specific VRF instance.

Example To display all ARP entries in the ARP cache, use the following command:

```
awplus# show arp
```

Output Figure 32-2: Example output from the **show arp** command

```
awplus#show arp
IP Address      LL Address      Interface      Port           Type
192.168.27.10   192.168.4.1     vlan1          port1.0.1      dynamic
192.168.27.100 0000.daaf.cd24  vlan1          port1.0.2      dynamic
...
```

Example (VRF-lite) To display the dynamic ARP entries in the global routing instance, use the command:

```
awplus# show arp global
```

Output Figure 32-3: Example output from the **show arp global** command

```
awplus#show arp global
IP Address      LL Address      Interface      Port           Type
192.168.10.2    0015.77ad.fad8 vlan1          port1.0.1     dynamic
192.168.20.2    0015.77ad.fa48 vlan2          port1.0.2     dynamic
192.168.1.100   00d0.6b04.2a42 vlan2          port1.0.3     static
```

Example (VRF-lite) To display the dynamic ARP entries for a VRF instance 'red', use the command:

```
awplus# show arp vrf red
```

Output Figure 32-4: Example output from the **show arp vrf red** command

```
awplus# show arp vrf red
[VRF: red]
IP Address      LL Address      Interface      Port           Type
192.168.10.2    0015.77ad.fad8 vlan1          port1.0.1     dynamic
```

Table 1: Parameters in the output of the **show arp** command

Parameter	Meaning
IP Address	IP address of the network device this entry maps to.
LL Address	Hardware address of the network device.
Interface	Interface over which the network device is accessed.
Port	Physical port that the network device is attached to.
Type	Whether the entry is a static or dynamic entry. Static entries are added using the arp command. Dynamic entries are learned from ARP request/reply message exchanges.
VRF	The name of the VRF instance. The VRF-lite components only display when VRF-lite is configured.

Related commands

- [arp](#)
- [clear arp-cache](#)
- [ip vrf](#)

Command changes

- Version 5.4.6-2.1: VRF-lite support added.
- Version 5.4.9-0.1: Link layer addresses now shown as the hardware address (MAC Address output parameter has been renamed to LL Address).

show crypto key pubkey-chain knownhosts

Overview This command displays the list of public keys maintained in the known host database on the device.

Syntax `show crypto key pubkey-chain knownhosts [<1-65535>]`

Syntax (VRF-lite) `show crypto key pubkey-chain knownhosts [vrf <vrf-name> | global] [<1-65535>]`

Parameter	Description
global	When VRF-lite is configured, apply the command to the global routing and forwarding table.
vrf	Apply the command to the specified VRF instance.
<i><vrf-name></i>	The name of the VRF instance.
<i><1-65535></i>	Key identifier for a specific key. Displays the public key of the entry if specified.

Default Display all keys.

Mode User Exec, Privileged Exec and Global Configuration

Usage When VRF-lite is configured:

- If **vrf** is specified, this command displays the known host database from the specified VRF instance.
- If **global** is specified, this command displays the known host database from the global routing environment.
- If neither **vrf** nor **global** is specified, this command displays the known host database from the global routing environment and each configured VRF.

For more information about VRF, see the [VRF Lite Feature Overview and Configuration Guide](#).

Examples To display public keys of known SSH servers, use the command:

```
awplus# show crypto key pubkey-chain knownhosts
```

To display the key data of the first entry in the known host data, use the command:

```
awplus# show crypto key pubkey-chain knownhosts 1
```

Output Figure 32-5: Example output from the **show crypto key public-chain knownhosts** command

No	Hostname	Type	Fingerprint
1	172.16.23.1	rsa	c8:33:b1:fe:6f:d3:8c:81:4e:f7:2a:aa:a5:be:df:18
2	172.16.23.10	rsa	c4:79:86:65:ee:a0:1d:a5:6a:e8:fd:1d:d3:4e:37:bd
3	5ffe:1053:ac21:ff00:0101:bcdf:ffff:0001	rsa1	af:4e:b4:a2:26:24:6d:65:20:32:d9:6f:32:06:ba:57

Table 2: Parameters in the output of the **show crypto key public-chain knownhosts** command

Parameter	Description
No	Number ID of the key.
Hostname	Host name of the known SSH server.
Type	The algorithm used to generate the key.
Fingerprint	Checksum value for the public key.

Related commands [crypto key pubkey-chain knownhosts](#)

Command changes Version 5.4.6-2.1: VRF-lite support added.

show ip bgp cidr-only (BGP only)

Overview Use this command to display routes with non-natural network masks.

For information on filtering and saving command output, see the [“Getting Started with AlliedWare Plus” Feature Overview and Configuration Guide](#).

Syntax `show ip bgp cidr-only`

Syntax (VRF-lite) `show ip bgp [global|vrf <vrf-name>] cidr-only`

Parameter	Description
global	When VRF-lite is configured, apply the command to the global routing and forwarding table.
vrf	Apply the command to the specified VRF instance.
<vrf-name>	The name of the VRF instance.

Mode User Exec and Privileged Exec

Example
`awplus# show ip bgp cidr-only`
`awplus# show ip bgp vrf red cidr-only`

Output Figure 32-6: Example output from the **show ip bgp cidr-only** command

```
BGP table version is 0, local router ID is 10.10.10.50

Status codes: s suppressed, d damped, h history, p stale, *
valid, > best, i - internal

Origin codes: i - IGP, e - EGP, ? - incomplete

   Network          Next Hop          Metric LocPrf Weight Path
*> 3.3.3.0/24      10.10.10.10              0 11 i
*> 6.6.6.0/24      0.0.0.0                32768 i

Total number of prefixes 2
```

Command changes Added to AlliedWare Plus prior to 5.4.6-1

Version 5.4.6-2.1: VRF-lite support added to BGP for AR-series products

Version 5.4.7-2.1: BGP support added for IEx510, x550 series

Version 5.4.7-2.4: BGP support added for IE300 series

show ip bgp community (BGP only)

Overview Use this command to display routes that match specified communities from a BGP instance within an IPv4 environment. Use the [show bgp ipv6 community \(BGP4+ only\)](#) command within an IPv6 environment.

For information on filtering and saving command output, see the [“Getting Started with AlliedWare Plus” Feature Overview and Configuration Guide](#).

You may use any combination and repetition of parameters listed in the *<type>* placeholder.

Syntax `show ip bgp community [<type>] [exact-match]`

Syntax (VRF-lite) `show ip bgp [global|vrf <vrf-name>] community [<type>] [exact-match]`

Parameter	Description
global	When VRF-lite is configured, apply the command to the global routing and forwarding table.
vrf	Apply the command to the specified VRF instance.
<i><vrf-name></i>	The name of the VRF instance.
<i><type></i>	{[AA:NN] [local-AS] [no-advertise] [no-export] }
AA:NN	Specifies the Autonomous System (AS) community number, in AA:NN format.
local-AS	Do not send outside local Autonomous Systems (well-known community).
no-advertise	Do not advertise to any peer (well-known community).
no-export	Do not export to next AS (well-known community).
exact-match	Specifies that the exact match of the communities is displayed. This optional parameter cannot be repeated.

Mode User Exec and Privileged Exec

Examples Note that the AS numbers shown are examples only.

```
awplus# show ip bgp community 64497:64499 exact-match
awplus# show ip bgp community 64497:64499 64500:64501
exact-match
awplus# show ip bgp community 64497:64499 64500:64501
64510:64511no-advertise
awplus# show ip bgp community no-advertise
no-advertiseno-advertise exact-match
awplus# show ip bgp community no-export 64510:64511
no-advertise local-AS no-export
awplus# show ip bgp community no-export 64510:64511
no-advertise 64497:64499 64500:64501 no-export
awplus# show ip bgp community no-export 64497:64499
no-advertise local-AS no-export
awplus# show ip bgp vrf red no-export
awplus# show ip bgp global 65500:2 65500:3 exact-match
```

Related commands [set community](#)
[show bgp ipv6 community \(BGP4+ only\)](#)

Command changes Added to AlliedWare Plus prior to 5.4.6-1
Version 5.4.6-2.1: VRF-lite support added to BGP for AR-series products
Version 5.4.7-2.1: BGP support added for IEx510, x550 series
Version 5.4.7-2.4: BGP support added for IE300 series

show ip bgp community-list (BGP only)

Overview Use this command to display routes that match the given community-list from a BGP instance within an IPv4 environment. Use the [show bgp ipv6 community-list \(BGP4+ only\)](#) command within an IPv6 environment.

For information on filtering and saving command output, see the [“Getting Started with AlliedWare Plus” Feature Overview and Configuration Guide](#).

Syntax `show ip bgp community-list <listname> [exact-match]`

Syntax (VRF-lite) `show ip bgp [global|vrf <vrf-name>] community-list <listname> [exact-match]`

Parameter	Description
global	When VRF-lite is configured, apply the command to the global routing and forwarding table.
vrf	Apply the command to the specified VRF instance.
<vrf-name>	The name of the VRF instance.
<listname>	Specifies the community list name.
exact-match	Displays only routes that have exactly the same specified communities.

Mode User Exec and Privileged Exec

Example

```
awplus# show ip bgp community-list mylist exact-match
awplus# show ip bgp vrf red community-list myCommunity
awplus# show ip bgp global community-list myExactCommunity
exact-match
```

Related commands [show bgp ipv6 community-list \(BGP4+ only\)](#)

Command changes

- Added to AlliedWare Plus prior to 5.4.6-1
- Version 5.4.6-2.1: VRF-lite support added to BGP for AR-series products
- Version 5.4.7-2.1: BGP support added for IEx510, x550 series
- Version 5.4.7-2.4: BGP support added for IE300 series

show ip bgp dampening (BGP only)

Overview Use this command to show dampened routes from a BGP instance within an IPv4 environment. Use the [show bgp ipv6 dampening \(BGP4+ only\)](#) command within an IPv6 environment.

For information on filtering and saving command output, see the [“Getting Started with AlliedWare Plus” Feature Overview and Configuration Guide](#).

Syntax `show ip bgp dampening`
{dampened-paths|flap-statistics|parameters}

Syntax (VRF-lite) `show ip bgp [global|vrf <vrf-name>] dampening`
{dampened-paths|flap-statistics|parameters}

Parameter	Description
global	When VRF-lite is configured, apply the command to the global routing and forwarding table.
vrf	Apply the command to the specified VRF instance.
<vrf-name>	The name of the VRF instance.
dampened-paths	Display paths suppressed due to dampening.
flap-statistics	Display flap statistics of routes.
parameters	Display details of configured dampening parameters.

Mode User Exec and Privileged Exec

Usage notes Enable BGP dampening to maintain dampened-path information in memory.

Examples `awplus# show ip bgp dampening dampened-paths`
`awplus# show ip bgp vrf red dampening dampened-paths`
`awplus# show ip bgp global dampening flap-statistics`

Output Figure 32-7: Example output from the **show ip bgp dampening** command

```
dampening 15 750 2000 60 15
  Reachability Half-Life time      : 15 min
  Reuse penalty                    : 750
  Suppress penalty                 : 2000
  Max suppress time                : 60 min
  Un-reachability Half-Life time  : 15 min
  Max penalty (ceil)              : 11999
  Min penalty (floor)             : 375
```

The following example output shows that the internal route (i), has flapped 3 times and is now categorized as history (h).

Figure 32-8: Example output from the **show ip bgp dampening flap-statistics** command

```
awplus# show ip bgp dampening flap-statistics
BGP table version is 1, local router ID is 30.30.30.77
Status codes: s suppressed, d damped, h history, * valid, > best, i - internal, S
Stale
Origin codes: i - IGP, e - EGP, ? - incomplete
  Network          From                Flaps  Duration  Reuse    Path
  ----          -
hi1.1.1.0/24      10.100.0.62          3    00:01:20    i
```

The following example output shows a dampened route in the 1.1.1.0/24 network.

Figure 32-9: Example output from the **show ip bgp dampening dampened-path** command

```
awplus# show ip bgp dampening dampened-paths
BGP table version is 1, local router ID is 30.30.30.77
Status codes: s suppressed, d damped, h history, * valid, > best, i - internal, S
Stale
Origin codes: i - IGP, e - EGP, ? - incomplete
  Network          From                Reuse    Path
  ----          -
di 1.1.1.0/24      10.100.0.62          00:35:10    i

Total number of prefixes 1
```

Related commands [show bgp ipv6 dampening \(BGP4+ only\)](#)

Command changes

- Added to AlliedWare Plus prior to 5.4.6-1
- Version 5.4.6-2.1: VRF-lite support added to BGP for AR-series products
- Version 5.4.7-2.1: BGP support added for IEx510, x550 series
- Version 5.4.7-2.4: BGP support added for IE300 series

show ip bgp filter-list (BGP only)

Overview Use this command to display routes conforming to the filter-list within an IPv4 environment. Use the [show bgp ipv6 filter-list \(BGP4+ only\)](#) command to display routes conforming to the filter-list within an IPv6 environment

For information on filtering and saving command output, see the [“Getting Started with AlliedWare Plus” Feature Overview and Configuration Guide](#).

Syntax `show ip bgp filter-list <listname>`

Syntax (VRF-lite) `show ip bgp [global|vrf <vrf-name>] filter-list <listname>`

Parameter	Description
global	When VRF-lite is configured, apply the command to the global routing and forwarding table.
vrf	Apply the command to the specified VRF instance.
<vrf-name>	The name of the VRF instance.
<listname>	Specifies the regular-expression access list name.

Mode User Exec and Privileged Exec

Example
awplus# show ip bgp filter-list mylist
awplus# show ip bgp vrf red filter-list mylist

Related commands [show bgp ipv6 filter-list \(BGP4+ only\)](#)

Command changes
Added to AlliedWare Plus prior to 5.4.6-1
Version 5.4.6-2.1: VRF-lite support added to BGP for AR-series products
Version 5.4.7-2.1: BGP support added for IEx510, x550 series
Version 5.4.7-2.4: BGP support added for IE300 series

show ip bgp inconsistent-as (BGP only)

Overview Use this command to display routes with inconsistent AS Paths within an IPv4 environment. Use the [show bgp ipv6 inconsistent-as \(BGP4+ only\)](#) command to display routes with inconsistent AS paths within an IPv6 environment.

For information on filtering and saving command output, see the [“Getting Started with AlliedWare Plus” Feature Overview and Configuration Guide](#).

Syntax `show ip bgp inconsistent-as`

Syntax (VRF-lite) `show ip bgp [global|vrf <vrf-name>] inconsistent-as`

Parameter	Description
global	When VRF-lite is configured, apply the command to the global routing and forwarding table.
vrf	Apply the command to the specified VRF instance.
<vrf-name>	The name of the VRF instance.

Mode User Exec and Privileged Exec

Example
`awplus# show ip bgp inconsistent-as`
`awplus# show ip bgp global inconsistent-as`

Related commands [show bgp ipv6 inconsistent-as \(BGP4+ only\)](#)

Command changes
Added to AlliedWare Plus prior to 5.4.6-1
Version 5.4.6-2.1: VRF-lite support added to BGP for AR-series products
Version 5.4.7-2.1: BGP support added for IEx510, x550 series
Version 5.4.7-2.4: BGP support added for IE300 series

show ip bgp longer-prefixes (BGP only)

Overview Use this command to display the route of the local BGP routing table for a specific prefix with a specific mask, or for any prefix having a longer mask than the one specified.

For information on filtering and saving command output, see the [“Getting Started with AlliedWare Plus” Feature Overview and Configuration Guide](#).

Syntax `show ip bgp <ip-address/m> longer-prefixes`

Syntax (VRF-lite) `show ip bgp [global|vrf <vrf-name>] <ip-address/m> longer-prefixes`

Parameter	Description
global	When VRF-lite is configured, apply the command to the global routing and forwarding table.
vrf	Apply the command to the specified VRF instance.
<vrf-name>	The name of the VRF instance.
<ip-address/m>	Neighbor’s IP address and subnet mask, entered in the form A.B.C.D/M, where M is the subnet mask length.

Mode User Exec and Privileged Exec

Example

```
awplus# show ip bgp 10.10.0.10/24 longer-prefixes
awplus# show ip bgp vrf red 172.16.4.0/24
awplus# show ip bgp global 172.16.0.0/16 longer-prefixes
```

Command changes

- Added to AlliedWare Plus prior to 5.4.6-1
- Version 5.4.6-2.1: VRF-lite support added to BGP for AR-series products
- Version 5.4.7-2.1: BGP support added for IEx510, x550 series
- Version 5.4.7-2.4: BGP support added for IE300 series

show ip bgp prefix-list (BGP only)

Overview Use this command to display routes matching the prefix-list within an IPv4 environment. Use the [show bgp ipv6 prefix-list \(BGP4+ only\)](#) command to display routes matching the prefix-list within an IPv6 environment.

For information on filtering and saving command output, see the [“Getting Started with AlliedWare Plus” Feature Overview and Configuration Guide](#).

Syntax `show ip bgp prefix-list <list>`

Syntax (VRF-lite) `show ip bgp [global|vrf <vrf-name>] prefix-list <list>`

Parameter	Description
global	When VRF-lite is configured, apply the command to the global routing and forwarding table.
vrf	Apply the command to the specified VRF instance.
<vrf-name>	The name of the VRF instance.
<list>	Specifies the name of the IP prefix list.

Mode User Exec and Privileged Exec

Examples
`awplus# show ip bgp prefix-list mylist`
`awplus# show ip bgp vrf red prefix-list myPrefixes`

Related commands [show bgp ipv6 prefix-list \(BGP4+ only\)](#)

Command changes
Added to AlliedWare Plus prior to 5.4.6-1
Version 5.4.6-2.1: VRF-lite support added to BGP for AR-series products
Version 5.4.7-2.1: BGP support added for IEx510, x550 series
Version 5.4.7-2.4: BGP support added for IE300 series

show ip bgp quote-regexp (BGP only)

Overview Use this command to display routes matching the AS path regular expression within an IPv4 environment. Use the [show bgp ipv6 quote-regexp \(BGP4+ only\)](#) command to display routes matching the AS path regular expression within an IPv6 environment.

Note that you must use quotes to enclose the regular expression with this command. Use the regular expressions listed below with the *<expression>* parameter:

Symbol	Character	Meaning
^	Caret	Used to match the beginning of the input string. When used at the beginning of a string of characters, it negates a pattern match.
\$	Dollar sign	Used to match the end of the input string.
.	Period	Used to match a single character (white spaces included).
*	Asterisk	Used to match none or more sequences of a pattern.
+	Plus sign	Used to match one or more sequences of a pattern.
?	Question mark	Used to match none or one occurrence of a pattern.
_	Underscore	Used to match spaces, commas, braces, parenthesis, or the beginning and end of an input string.
[]	Brackets	Specifies a range of single-characters.
-	Hyphen	Separates the end points of a range.

For information on filtering and saving command output, see the [“Getting Started with AlliedWare Plus” Feature Overview and Configuration Guide](#).

Syntax `show ip bgp quote-regexp <expression>`

Syntax (VRF-lite) `show ip bgp [global|vrf <vrf-name>] quote-regexp <expression>`

Parameter	Description
global	When VRF-lite is configured, apply the command to the global routing and forwarding table.
vrf	Apply the command to the specified VRF instance.
<vrf-name>	The name of the VRF instance.
<expression>	Specifies a regular-expression to match the BGP AS paths.

Mode User Exec and Privileged Exec

Examples awplus# show ip bgp quote-regexp myexpression
awplus# show ip bgp global quote-regexp 65550 65555

Related commands [show bgp ipv6 quote-regexp \(BGP4+ only\)](#)

Command changes Added to AlliedWare Plus prior to 5.4.6-1
Version 5.4.6-2.1: VRF-lite support added to BGP for AR-series products
Version 5.4.7-2.1: BGP support added for IEx510, x550 series
Version 5.4.7-2.4: BGP support added for IE300 series

show ip bgp regexp (BGP only)

Overview Use this command to display routes matching the AS path regular expression within an IPv4 environment. Use the [show bgp ipv6 regexp \(BGP4+ only\)](#) command to display routes matching the AS path regular expression within an IPv6 environment.

Use the regular expressions listed below with the `<expression>` parameter:

Symbol	Character	Meaning
^	Caret	Used to match the beginning of the input string. When used at the beginning of a string of characters, it negates a pattern match.
\$	Dollar sign	Used to match the end of the input string.
.	Period	Used to match a single character (white spaces included).
*	Asterisk	Used to match none or more sequences of a pattern.
+	Plus sign	Used to match one or more sequences of a pattern.
?	Question mark	Used to match none or one occurrence of a pattern.
_	Underscore	Used to match spaces, commas, braces, parenthesis, or the beginning and end of an input string.
[]	Brackets	Specifies a range of single-characters.
-	Hyphen	Separates the end points of a range.

For information on filtering and saving command output, see the [“Getting Started with AlliedWare Plus” Feature Overview and Configuration Guide](#).

Syntax `show ip bgp regexp <expression>`

Syntax (VRF-lite) `show ip bgp [global|vrf <vrf-name>] regexp <expression>`

Parameter	Description
global	When VRF-lite is configured, apply the command to the global routing and forwarding table.
vrf	Apply the command to the specified VRF instance.
<vrf-name>	The name of the VRF instance.
<expression>	Specifies a regular-expression to match the BGP AS paths.

Mode User Exec and Privileged Exec

Examples awplus# show ip bgp regexp myexpression
 awplus# show ip bgp vrf red regexp 65550 65555

Related commands [show bgp ipv6 regexp \(BGP4+ only\)](#)

Command changes Added to AlliedWare Plus prior to 5.4.6-1
 Version 5.4.6-2.1: VRF-lite support added to BGP for AR-series products
 Version 5.4.7-2.1: BGP support added for IEx510, x550 series
 Version 5.4.7-2.4: BGP support added for IE300 series

show ip bgp route-map (BGP only)

Overview Use this command to display BGP routes that match the specified route-map within an IPv4 environment. Use the [show bgp ipv6 route-map \(BGP4+ only\)](#) command to display BGP4+ routes that match the specified route-map within an IPv6 environment.

For information on filtering and saving command output, see the [“Getting Started with AlliedWare Plus” Feature Overview and Configuration Guide](#).

Syntax `show ip bgp route-map <route-map>`

Syntax (VRF-lite) `show ip bgp [global|vrf <vrf-name>] route-map <route-map>`

Parameter	Description
global	When VRF-lite is configured, apply the command to the global routing and forwarding table.
vrf	Apply the command to the specified VRF instance.
<vrf-name>	The name of the VRF instance.
<route-map>	Specifies a route-map that is matched.

Mode User Exec and Privileged Exec

Examples To show routes that match the route-map `myRouteMap` for the global routing instance, use the command:

```
awplus# show ip bgp global route-map myRouteMap
```

To show routes that match the route-map `myRouteMap`, use the command:

```
awplus# show ip bgp route-map myRouteMap
```

Related commands [show bgp ipv6 route-map \(BGP4+ only\)](#)

Command changes

- Added to AlliedWare Plus prior to 5.4.6-1
- Version 5.4.6-2.1: VRF-lite support added to BGP for AR-series products
- Version 5.4.7-2.1: BGP support added for IEx510, x550 series
- Version 5.4.7-2.4: BGP support added for IE300 series

show http client

Overview Use this command to show the current HTTP client VRF.

Syntax `show http client`

Mode Privileged Exec

Usage notes If no VRF has been set, the show command shows 'None'.

Example To display the HTTP client VRF, use the commands:

```
awplus# show http client
```

Output Figure 32-10: Example output from **show http client**

```
awplus#show http client
Hyper-Text Transfer Protocol Client Configuration
-----
VRF                                     : MyVRFPoE
```

Related commands [copy \(filename\)](#)

Command changes Version 5.5.2-1.1: command added

show ip bgp summary (BGP only)

Overview Use this command to display a summary of a BGP neighbor status within an IPv4 environment. Use the [show bgp ipv6 summary \(BGP4+ only\)](#) command to display a summary of BGP4+ neighbors.

For information on filtering and saving command output, see the [“Getting Started with AlliedWare Plus” Feature Overview and Configuration Guide](#).

Syntax `show ip bgp summary`

Syntax (VRF-lite) `show ip bgp [global|vrf <vrf-name>] summary`

Parameter	Description
global	When VRF-lite is configured, apply the command to the global routing and forwarding table.
vrf	Apply the command to the specified VRF instance.
<vrf-name>	The name of the VRF instance.

Mode User Exec and Privileged Exec

Examples `awplus# show ip bgp summary`
`awplus# show ip bgp vrf red summary`

Output Figure 32-11: Example output from the **show ip bgp summary** command

```
awplus>show ip bgp summary

BGP router identifier 1.0.0.1, local AS number 65541
BGP table version is 12
4 BGP AS-PATH entries
0 BGP community entries

Neighbor      V      AS      MsgRc  MsgSnt  TblVer  InOutQ  Up/Down      State/PfxRcd
192.168.3.2   4      65544   20     24     11 0/0    00:07:19    1
192.168.4.2   4      65545   0      0      0 0/0    never        Active
192.168.11.2  4      65542   34     40     0 0/0    00:00:04    Active
192.168.21.2  4      65543   29     32     11 0/0    00:07:03    13

Number of neighbors 4
```

The Up/Down column in this output is a timer that shows:

- "never" if the peer session has never been established
- The up time, if the peer session is currently up
- The down time, if the peer session is currently down.

In the example above, the session with 192.168.11.2 has been down for 4 seconds, and the session with 192.168.4.2 has never been established.

Related commands [show bgp ipv6 summary \(BGP4+ only\)](#)

Command changes

- Added to AlliedWare Plus prior to 5.4.6-1
- Version 5.4.6-2.1: VRF-lite support added to BGP for AR-series products
- Version 5.4.7-2.1: BGP support added for IEx510, x550 series
- Version 5.4.7-2.4: BGP support added for IE300 series

show ip interface vrf

Overview Use this command to display protocol and status information about configured interfaces and their assigned IP addresses in VRF instances.

For information on filtering and saving command output, see the [“Getting Started with AlliedWare Plus” Feature Overview and Configuration Guide](#).

Syntax `show ip interface [vrf <vrf-name>|global]`

Parameter	Description
vrf	A VRF instance.
<vrf-name>	The name of a specific VRF instance.
global	The global routing and forwarding table.

Mode User Exec and Privileged Exec

Examples To display all interfaces and IP addresses associated with a VRF instance ‘red’, use the command:

```
awplus# show ip interface vrf red
```

Output Figure 32-12: Example output from **show ip interface vrf red**

Interface	IP-Address	Status	Protocol
lol	unassigned	admin up	running
vlan1	192.168.10.1/24	admin up	running

Example To display all interfaces and IP addresses associated with all VRF instances, use the command:

```
awplus# show ip interface
```

Output Figure 32-13: Example output from the **show ip interface** with VRF-lite configured

Interface	IP-Address	Status	Protocol
eth0	unassigned	admin up	down
lo	unassigned	admin up	running
vlan1	192.168.1.1/24	admin up	running
vlan4	172.30.4.43/24	admin up	down
[VRF: red]			
Interface	IP-Address	Status	Protocol
lo1	unassigned	admin up	running
[VRF: blue]			
Interface	IP-Address	Status	Protocol
lo2	unassigned	admin up	running

Command changes Version 5.4.6-2.1: VRF-lite support added.

show ip rip vrf database

Overview Use this command to display information about the RIP database that is associated with a specific VRF instance.

Entering this command with the **full** option included, will display information about the full RIP database (including sub-optimal routes) associated with a specific VRF instance.

For information on filtering and saving command output, see the [“Getting Started with AlliedWare Plus” Feature Overview and Configuration Guide](#).

Syntax `show ip rip {vrf <vrf-name>|global} database [full]`

Parameter	Description
vrf	Specific VRF instance.
<vrf-name>	The name of the VRF instance.
global	The global routing and forwarding table.
full	Specify the full RIP database including sub-optimal RIP routes.

Mode User Exec and Privileged Exec

Example To display information about the RIP database associated with a VRF instance 'blue', use the command:

```
awplus# show ip rip vrf blue database
```

Output Figure 32-14: Example output from the **show ip rip vrf blue database** command

```
Codes: R - RIP, Rc - RIP connected, Rs - RIP static
       C - Connected, S - Static, O - OSPF, B - BGP
```

Network	Next Hop	Metric	From	If	Time
Rc 192.168.30.0/24		1		vlan3	
R 192.168.45.0/24	192.168.30.1	2	192.168.30.1	vlan3	02:46

Related commands [show ip rip](#)

Command changes Version 5.4.6-2.1: VRF-lite support added.

show ip rip vrf interface

Overview Use this command to display information about the RIP interfaces that are associated with a specific VRF instance.

For information on filtering and saving command output, see the [“Getting Started with AlliedWare Plus” Feature Overview and Configuration Guide](#).

Syntax `show ip rip {vrf <vrf-name>|global} interface [<interface-name>]`

Parameter	Description
vrf	Specific VRF instance.
<vrf-name>	The name of the VRF instance.
global	The global routing and forwarding table.
<interface-name>	The IP RIP interface (VLAN).

Mode User Exec and Privileged Exec

Example To display information about the RIP database associated with a VRF instance 'blue', use the command:

```
awplus# show ip rip vrf blue interface
```

Output Figure 32-15: Example output from **show ip rip vrf blue interface vlan3**

Network	Next Hop	Metric	From	If	Time
Rc 192.168.30.0/24		1		vlan3	
R 192.168.45.0/24	192.168.30.1	2	192.168.30.1	vlan3	02:46

NOTE: The Time parameter operates as follows:

- RIP updates occur approximately every 30 seconds.
- Each update resets a count-down timer to 180 seconds (3 minutes).
- The Time parameter displays the count-down from the last reset.

Related commands [show ip rip](#)

Command changes Version 5.4.6-2.1: VRF-lite support added.

show ip route

Overview Use this command to display routing entries in the FIB (Forwarding Information Base). The FIB contains the best routes to a destination, and your device uses these routes when forwarding traffic. You can display a subset of the entries in the FIB based on protocol.

To modify the lines displayed, use the | (output modifier token); to save the output to a file, use the > output redirection token.

VRF-lite If VRF-lite is configured, you can display routing entries in the FIB associated with either the global routing domain or a named VRF.

Syntax `show ip route [bgp|connected|ospf|rip|static|
<ip-addr>|<ip-addr/prefix-length>]`

Syntax (VRF-lite) `show ip route {vrf <vrf-name>|global}
[bgp|connected|ospf|rip|static]`

Parameter	Description
global	If VRF-lite is configured, apply the command to the global routing and forwarding table.
vrf	Apply the command to the specified VRF instance.
<vrf-name>	The name of the VRF instance.
bgp	Displays only the routes learned from BGP.
connected	Displays only the routes learned from connected interfaces.
ospf	Displays only the routes learned from OSPF.
rip	Displays only the routes learned from RIP.
static	Displays only the static routes you have configured.
<ip-addr>	Displays the routes for the specified address. Enter an IPv4 address.
<ip-addr/prefix-length>	Displays the routes for the specified network. Enter an IPv4 address and prefix length.

Mode User Exec and Privileged Exec

Examples To display the static routes in the FIB, use the command:

```
awplus# show ip route static
```

To display the OSPF routes in the FIB, use the command:

```
awplus# show ip route ospf
```

Example (VRF-lite) To display all routing entries in the FIB associated with a VRF instance `red`, use the command:

```
awplus# show ip route vrf red
```

Output Each entry in the output from this command has a code preceding it, indicating the source of the routing entry. For example, O indicates OSPF as the origin of the route. The first few lines of the output list the possible codes that may be seen with the route entries.

Typically, route entries are composed of the following elements:

- code
- a second label indicating the sub-type of the route
- network or host IP address
- administrative distance and metric
- next hop IP address
- outgoing interface name
- time since route entry was added

Figure 32-16: Example output from the **show ip route** command

```
Codes: C - connected, S - static, R - RIP, B - BGP
O - OSPF, IA - OSPF inter area
N1 - OSPF NSSA external type 1, N2 - OSPF NSSA external type 2
E1 - OSPF external type 1, E2 - OSPF external type 2
* - candidate default

O    10.10.37.0/24 [110/11] via 10.10.31.16, vlan2, 00:20:54
C    3.3.3.0/24 is directly connected, vlan1
C    10.10.31.0/24 is directly connected, vlan2
C    10.70.0.0/24 is directly connected, vlan4
O E2 14.5.1.0/24 [110/20] via 10.10.31.16, vlan2, 00:18:56
C    33.33.33.33/32 is directly connected, lo
```

Connected Route An example of a connected route entry consists of:

```
C    10.10.31.0/24 is directly connected, eth1
```

This route entry denotes:

- Route entries for network 10.10.31.0/24 are derived from the IP address of local interface eth1.
- These routes are marked as Connected routes (C) and always preferred over routes for the same network learned from other routing protocols.

OSPF Route An example of an OSPF route entry consists of:

```
O    10.10.37.0/24 [110/11] via 10.10.31.16, eth1, 00:20:54
```

This route entry denotes:

- This route in the network 10.10.37.0/24 was added by OSPF.
- This route has an administrative distance of 110 and metric/cost of 11.
- This route is reachable via next hop 10.10.31.16.
- The outgoing local interface for this route is eth1.
- This route was added 20 minutes and 54 seconds ago.

OSPF External Route

An example of an OSPF external route entry consists of:

```
O E2 14.5.1.0/24 [110/20] via 10.10.31.16, eth1, 00:18:56
```

This route entry denotes that this route is the same as the other OSPF route explained above; the main difference is that it is a Type 2 External OSPF route.

Weight for Static Route

If the **weight** parameter has been set using the **ip route** command, it will be shown in the output:

```
S 10.10.37.0/24 [110/11] via 10.10.31.16, vlan2 weight 5  
via 10.10.31.32, vlan2 weight 1
```

AlliedWare Plus distributes the work load based on the number of sessions that are connected through the interfaces. It uses the weight that you assign to each interface to calculate a percentage of the total sessions that are allowed to connect through each interface. It then distributes the number of sessions between the interfaces accordingly.

Related commands

[ip route](#)
[ip route vrf](#)
[maximum-paths](#)
[show ip route database](#)

Command changes

Version 5.4.6-2.1: VRF-lite support added.

show ip route database

Overview This command displays the routing entries in the RIB (Routing Information Base).

When multiple entries are available for the same prefix, RIB uses the routes' administrative distances to choose the best route. All best routes are entered into the FIB (Forwarding Information Base). To view the routes in the FIB, use the [show ip route](#) command.

To modify the lines displayed, use the | (output modifier token); to save the output to a file, use the > (output redirection token).

Syntax `show ip route database [bgp|connected|ospf|rip|static]`

Syntax (VRF-lite) `show ip route [vrf <vrf-name>|global] database [bgp|connected|ospf|rip|static]`

Parameter	Description
global	If VRF-lite is configured, apply the command to the global routing and forwarding table.
vrf	Apply the command to the specified VRF instance.
<vrf-name>	The name of the VRF instance.
bgp	Displays only the routes learned from BGP.
connected	Displays only the routes learned from connected interfaces.
ospf	Displays only the routes learned from OSPF.
rip	Displays only the routes learned from RIP.
static	Displays only the static routes you have configured.

Mode User Exec and Privileged Exec

Example To display the static routes in the RIB, use the command:

```
awplus# show ip route database static
```

Output Figure 32-17: Example output from the **show ip route database** command:

```
Codes: C - connected, S - static, R - RIP, B - BGP
       O - OSPF, IA - OSPF inter area
       N1 - OSPF NSSA external type 1, N2 - OSPF NSSA external type 2
       E1 - OSPF external type 1, E2 - OSPF external type 2
       > - selected route, * - FIB route, p - stale info

O    *> 9.9.9.9/32 [110/31] via 10.10.31.16, vlan2, 00:19:21
O    10.10.31.0/24 [110/1] is directly connected, vlan2, 00:28:20
C    *> 10.10.31.0/24 is directly connected, vlan2
S    *> 10.10.34.0/24 [1/0] via 10.10.31.16, vlan2
O    10.10.34.0/24 [110/31] via 10.10.31.16, vlan2, 00:21:19
O    *> 10.10.37.0/24 [110/11] via 10.10.31.16, vlan2, 00:21:19
C    *> 10.30.0.0/24 is directly connected, vlan6
S    *> 11.22.11.0/24 [1/0] via 10.10.31.16, vlan2
O E2 *> 14.5.1.0/24 [110/20] via 10.10.31.16,vlan2, 00:19:21
O    16.16.16.16/32 [110/11] via 10.10.31.16, vlan2, 00:21:19
S    *> 16.16.16.16/32 [1/0] via 10.10.31.16, vlan2
O    *> 17.17.17.17/32 [110/31] via 10.10.31.16, vlan2, 00:21:19
C    *> 45.45.45.45/32 is directly connected, lo
O    *> 55.55.55.55/32 [110/21] via 10.10.31.16, vlan2, 00:21:19
C    *> 127.0.0.0/8 is directly connected, lo
```

Example (VRF-lite) To display all routing entries in the RIB associated with a VRF instance `red`, use the command:

```
awplus# show ip route vrf red database
```

Output Figure 32-18: Example output from the **show ip route vrf red database** command

```
[VRF: red]
Codes: C - connected, S - static, R - RIP, B - BGP
       O - OSPF, IA - OSPF inter area
       N1 - OSPF NSSA external type 1, N2 - OSPF NSSA external type 2
       E1 - OSPF external type 1, E2 - OSPF external type 2
       > - selected route, * - FIB route, p - stale info

O    192.168.10.0/24 [110/1] is directly connected, vlan1, 06:45:51
C    *> 192.168.10.0/24 is directly connected, vlan1
B    > 192.168.33.0/24 [20/0] via 192.168.30.3, 06:45:52
O E2 *> 192.168.110.0/24 [110/20] via 192.168.10.2, vlan1, 06:45:00
O E2 *> 192.168.111.0/24 [110/20] via 192.168.10.2, vlan1, 06:45:00
```

The routes added to the FIB are marked with a *. When multiple routes are available for the same prefix, the best route is indicated with the > symbol. All unselected routes have neither the * nor the > symbol.

```
S    *> 10.10.34.0/24 [1/0] via 10.10.31.16, vlan2
O    10.10.34.0/24 [110/31] via 10.10.31.16, vlan2, 00:21:19
```

These route entries denote:

- The same prefix was learned from OSPF and from static route configuration.

- Since this static route has a lower administrative distance than the OSPF route (110), the static route (1) is selected and installed in the FIB.

If the static route becomes unavailable, then the device automatically selects the OSPF route and installs it in the FIB.

Related commands [maximum-paths](#)
[show ip route](#)

Command changes Version 5.4.6-2.1: VRF-lite support added.

show ip route summary

Overview This command displays a summary of the current RIB (Routing Information Base) entries.

To modify the lines displayed, use the | (output modifier token); to save the output to a file, use the > output redirection token.

Syntax show ip route summary

Syntax (VRF-lite) show ip route summary [vrf <vrf-name>|global]

Parameter	Description
vrf	Specific VRF instance.
<vrf-name>	The name of the VRF instance.
global	The global routing and forwarding table.

Mode User Exec and Privileged Exec

Example To display a summary of the current RIB entries, use the command:

```
awplus# show ip route summary
```

Output Figure 32-19: Example output from the **show ip route summary** command

```
IP routing table name is Default-IP-Routing-Table(0)
IP routing table maximum-paths is 4
Route Source      Networks
connected         5
ospf              2
Total             8
```

Example (VRF-lite) To display a summary of the current RIB entries associated with a VRF instance red, use the command:

```
awplus# show ip route summary vrf red
```

Output Figure 32-20: Example output from the **show ip route summary vrf red** command

```
IP routing table name is Default-IP-Routing-Table(0)
IP routing table maximum-paths is 4
Route Source      Networks
connected         1
Total             1
FIB               0

[VRF: red]
Route Source      Networks
connected         1
ospf              2
Total             3
```

Related commands [show ip route](#)
[show ip route database](#)

Command changes Version 5.4.6-2.1: VRF-lite support added.

show ip vrf

Overview This command displays brief configurations for a specific VRF instance.

Syntax `show ip vrf <vrf-name>`

Parameter	Description
<code><vrf-name></code>	The name of the VRF instance.

Mode User Exec and Privileged Exec

Example To display brief information for the VRF instance red, use the command:

```
awplus# show ip vrf red
```

Output Figure 32-21: Example output from the show ip vrf red command

Name	Default RD	Interfaces
red	500:1	lo1, vlan1

Related commands [show ip vrf interface](#)

Command changes Version 5.4.6-2.1: VRF-lite support added.

show ip vrf detail

Overview This command displays the detailed configuration for a specific VRF instance.

Syntax `show ip vrf detail <vrf-name>`

Parameter	Description
<code><vrf-name></code>	The name of the VRF instance.

Mode User Exec and Privileged Exec

Example To display the detailed information for all VRF instances, use the command:

```
awplus# show ip vrf detail
```

Output Figure 32-22: Example output from the **show ip detail** command, for all VRF instances

```
VRF blue; Description: VRF for customer blue
FIB ID 3; Router ID: 192.168.30.1 (automatic)
Default RD 500:3
  Interfaces:
    lo3, vlan3
  Export route-target communities
    RT: 500:3
  Import route-target communities
    RT: 500:4
  Import route-map: blue45
  No export route-map

VRF red
FIB ID 1; Router ID: 192.168.10.1 (automatic)
Default RD 500:1
  Interfaces:
    lo1, vlan1
  Export route-target communities
    RT: 500:1
  Import route-target communities
    RT: 500:1
  Import route-map: red43
  No export route-map
```

Related commands [show ip vrf](#)

Command changes Version 5.4.6-2.1: VRF-lite support added.

show ip vrf interface

Overview This command displays protocol, operational status, and address information, for interfaces existing within either a specified VRF instance, or all VRF instances.

Syntax `show ip vrf interface <vrf-name>`

Parameter	Description
<vrf-name>	The name of the VRF instance.

Mode User Exec and Privileged Exec

Example To display all interfaces and IP addresses associated with all VRF instances, use the command:

```
awplus# show ip vrf interface
```

Output Figure 32-23: Example output from the **show ip vrf interface** command

Interface	IP-Address	Status	Protocol	Vrf
lo1	unassigned	admin up	running	red
lo2	unassigned	admin up	running	green
vlan1	192.168.10.1/24	admin up	running	red
vlan2	192.168.20.1/24	admin up	running	green

Example To display all interfaces and IP addresses associated with the VRF instance `red`, use the command:

```
awplus# show ip vrf interface red
```

Output Figure 32-24: Example output from the **show ip vrf interface red** command

Interface	IP-Address	Status	Protocol	Vrf
lo1	unassigned	admin up	running	red
vlan1	192.168.10.1/24	admin up	running	red

Related commands [show ip vrf](#)

Command changes Version 5.4.6-2.1: VRF-lite support added.

snmp-server host

Overview This command specifies an SNMP trap host destination to which Trap or Inform messages generated by the device are sent.

For SNMP version 1 and 2c you must specify the community name parameter. For SNMP version 3, specify the authentication/encryption parameters and the user name. If the version is not specified, the default is SNMP version 1. Inform messages can be sent instead of traps for SNMP version 2c and 3.

Use the **no** variant of this command to remove an SNMP trap host. The trap host must already exist.

The trap host is uniquely identified by:

- host IP address (IPv4 or IPv6),
- inform or trap messages,
- community name (SNMPv1 or SNMP v2c) or the authentication/encryption parameters and user name (SNMP v3).

Syntax

```
snmp-server host {<ipv4-address>|<ipv6-address>} [traps]
[version 1] <community-name>

snmp-server host {<ipv4-address>|<ipv6-address>}
[informs|traps] version 2c <community-name>

snmp-server host {<ipv4-address>|<ipv6-address>}
[informs|traps] version 3 {auth|noauth|priv} <user-name>

no snmp-server host {<ipv4-address>|<ipv6-address>} [traps]
[version 1] <community-name>

no snmp-server host {<ipv4-address>|<ipv6-address>}
[informs|traps] version 2c <community-name>

no snmp-server host {<ipv4-address>|<ipv6-address>}
[informs|traps] version 3 {auth|noauth|priv} <user-name>
```

Syntax (VRF-Lite)

```
snmp-server host {<ipv4-address>|<ipv6-address>} [vrf
<vrf-name>] [informs|traps] version 1|2c|3 {auth|noauth|priv}
<user-name> {<community-name>|<user-name>}

no snmp-server host {<ipv4-address>|<ipv6-address>} [vrf
<vrf-name>] [informs|traps] version 1|2c|3 {auth|noauth|priv}
<user-name> {<community-name>|<user-name>}
```

Parameter	Description
<ipv4-address>	IPv4 trap host address in the format A.B.C.D, for example, 192.0.2.2.
<ipv6-address>	IPv6 trap host address in the format x:x::x:x for example, 2001:db8::8a2e:7334.
vrf <vrf-name>	Specify the VRF instance to use. If you do not specify an instance it will use the global VRF.

Parameter	Description
informs	Send Inform messages to this host.
traps	Send Trap messages to this host (default).
version	SNMP version to use for notification messages. Default: version 1.
1	Use SNMPv1 (default).
2c	Use SNMPv2c.
3	Use SNMPv3.
auth	Authentication.
noauth	No authentication.
priv	Encryption.
<community-name>	The SNMPv1 or SNMPv2c community name.
<user-name>	SNMPv3 user name.

Mode Global Configuration

Examples To configure the device to send generated traps to the IPv4 host destination 192.0.2.5 with the SNMPv2c community name 'public', use the following commands:

```
awplus# configure terminal
awplus(config)# snmp-server host 192.0.2.5 version 2c public
```

To configure the device to send generated traps to the IPv6 host destination 2001:db8::8a2e:7334 with the SNMPv2c community name 'private', use the following commands:

```
awplus# configure terminal
awplus(config)# snmp-server host 2001:db8::8a2e:7334 version 2c
private
```

To remove a configured trap host of 192.0.2.5 with the SNMPv2c community name 'public', use the following commands:

```
awplus# configure terminal
awplus(config)# no snmp-server host 192.0.2.5 version 2c public
```

To configure the device to send generated traps to an IPv4 host destination 192.168.1.2 with the SNMPv2c community name 'public' and on a VRF named 'red', use the following commands:

```
awplus# configure terminal
awplus(config)# snmp-server host 192.0.1.2 vrf red version 2c
public
```

Related commands `snmp trap link-status`
`snmp-server enable trap`
`snmp-server view`

Command changes Version 5.5.2-1.1: **vrf** parameter added for products that support VRF

show running-config vrf

Overview This command displays the running system VRF-related configurations for all VRF instances.

Syntax `show running-config vrf`

Mode Privileged Exec

Example To display the running system VRF-related configurations, use the command:

```
awplus# show running-config vrf
```

Output Figure 32-25: Example output from the **show running config vrf** command

```
ip vrf red
rd 500:1
route-target export 500:1
route-target export 500:4
import map red 43
!
```

Related commands [show ip vrf](#)

ssh

Overview Use this command to initiate a Secure Shell connection to a remote SSH server.

If the server requests a password to login, you need to type in the correct password at the "Password:" prompt.

An SSH client identifies the remote SSH server by its public key registered on the client device. If the server identification is changed, server verification fails. If the public key of the server has been changed, the public key of the server must be explicitly added to the known host database.

NOTE: A hostname specified with SSH cannot begin with a hyphen (-) character.

Syntax `ssh [ip|ipv6] [user <username>|port <1-65535>|version 2] <remote-device> [<command>]`

Syntax (VRF-lite) `ssh vrf <vrf-name> [ip|ipv6] [user <username>|port <1-65535>|version 2] <remote-device> [<command>]`

Parameter	Description
vrf	Apply the command to the specified VRF instance. When using VRF, specifying a VRF name means the command will apply to that VRF instance, and not specifying a VRF name means the command will apply to the global VRF.
<vrf-name>	The name of the VRF instance.
ip	Specify IPv4 SSH.
ipv6	Specify IPv6 SSH.
user	Login user. If user is specified, the username is used for login to the remote SSH server when user authentication is required. Otherwise the current user name is used. <username> User name to login on the remote server.
port	SSH server port. If port is specified, the SSH client connects to the remote SSH server with the specified TCP port. Otherwise, the client port configured by "ssh client" command or the default TCP port (22) is used. <1-65535> TCP port.
version	SSH client version. From 5.5.1-1.1 onwards, SSH only supports version 2.
<remote-device>	IPv4/IPv6 address or hostname of a remote server. The address is in the format A.B.C.D for an IPv4 address, or in the format X:X::X:X for an IPv6 address. Note that a hostname specified with SSH cannot begin with a hyphen (-) character.
<command>	A command to execute on the remote server. If a command is specified, the command is executed on the remote SSH server and the session is disconnected when the remote command finishes.

Mode User Exec and Privileged Exec

Examples To login to the remote SSH server at 192.0.2.5, use the command:

```
awplus# ssh ip 192.0.2.5
```

To login to the remote SSH server at 192.0.2.5 as user 'manager', use the command:

```
awplus# ssh ip user manager 192.0.2.5
```

To login to the remote SSH server at 192.0.2.5 that is listening on TCP port 2000, use the command:

```
awplus# ssh port 2000 192.0.2.5
```

To login to the remote SSH server 'example_host' using an IPv6 session, use the command:

```
awplus# ssh ipv6 example_host
```

To run the **cmd** command on the remote SSH server at 192.0.2.5, use the command:

```
awplus# ssh ip 192.0.2.5 cmd
```

Example (VRF-lite) To login to the remote SSH server at 192.168.1.1 on VRF "red", use the command:

```
awplus# ssh vrf red 192.168.1.1
```

Related commands

- [crypto key generate userkey](#)
- [crypto key pubkey-chain knownhosts](#)
- [debug ssh client](#)
- [ssh client](#)

Command changes

- Version 5.4.6-2.1: VRF-lite support added for AR-Series devices.
- Version 5.4.8-1.2: secure mode syntax added for x220, x930, x550, XS900MX.
- Version 5.4.8-2.1: secure mode syntax added for x950, SBx908 GEN2.
- Version 5.5.1-1.1: support removed for SSH protocol v1

ssh client

Overview This command modifies the default configuration parameters of the Secure Shell (SSH) client. The configuration is used for any SSH client on the device to connect to remote SSH servers. Any parameters specified on SSH client explicitly override the default configuration parameters.

The change affects the current user shell only. When the user exits the login session, the configuration does not persist. This command does not affect existing SSH sessions.

The **no** variant of this command resets configuration parameters of the Secure Shell (SSH) client changed by the `ssh client` command, and restores the defaults.

This command does not affect the existing SSH sessions.

Syntax

```
ssh client {port <1-65535>|version 2|session-timeout <0-3600>|connect-timeout <1-600>}
no ssh client {port|version|session-timeout|connect-timeout}
```

Syntax (VRF-lite)

```
ssh client {port <1-65535>|version 2|session-timeout <0-3600>|connect-timeout <1-600>|vrf <vrf-name>}
no ssh client
{port|version|session-timeout|connect-timeout|vrf}
```

Parameter	Description
port	The default TCP port of the remote SSH server. If an SSH client specifies an explicit port of the server, it overrides the default TCP port. Default: 22 <1-65535> TCP port number.
version	The SSH version used by the client for SSH sessions. From 5.5.1-1.1 onwards, the SSH client supports only version 2
session-timeout	The global session timeout for SSH sessions. If the session timer lapses since the last time an SSH client received data from the remote server, the session is terminated. If the value is 0, then the client does not terminate the session. Instead, the connection is terminated when it reaches the TCP timeout. Default: 0 (session timer remains off) <0-3600> Timeout in seconds.
connect-timeout	The maximum time period that an SSH session can take to become established. The SSH client terminates the SSH session if this timeout expires and the session is still not established. Default: 30 <1-600> Timeout in seconds.
vrf <vrf-name>	The VRF to use for SSH clients. Default: the global VRF.

Mode Privileged Exec

Examples To configure the default TCP port for SSH clients to 2200, and the session timer to 10 minutes, use the command:

```
awplus# ssh client port 2200 session-timeout 600
```

To configure the connect timeout of SSH client to 10 seconds, use the command:

```
awplus# ssh client connect-timeout 10
```

To restore the connect timeout to its default, use the command:

```
awplus# no ssh client connect-timeout
```

Example (VRF-lite) To configure SSH clients to use the VRF named 'red', use the command:

```
awplus# ssh client vrf red
```

Related commands [show ssh client](#)
[ssh](#)

Command changes Version 5.5.2-1.1: **vrf** parameter added for products that support VRF
Version 5.5.1-1.1: support removed for the ssh-rsa algorithm in OpenSSH and for SSH protocol v1

ssh server vrf

Overview Use this command to specify a VRF for the SSH server to operate within.
Use the **no** variant of this command to return the SSH server to the default VRF.

Syntax `ssh server vrf [<vrf-name>]`
`no ssh server vrf`

Parameter	Description
<vrf-name>	The name of the VRF instance

Default The global VRF

Mode Global Configuration

Example To configure the SSH server to operate within the VRF instance named 'red', use the command:

```
awplus# configure terminal
awplus(config)# ssh server vrf red
```

To return the SSH server to operating within the global VRF instance, use the command:

```
awplus# configure terminal
awplus(config)# no ssh server vrf
```

Related commands [show ssh server](#)
[ssh](#)
[ssh server](#)

Command changes Version 5.5.2-1.1: command added

tacacs-server host

Overview Use this command to specify a remote TACACS+ server host for authentication, authorization and accounting, and to set the shared secret key to use with the TACACS+ server. The parameters specified with this command override the corresponding global parameters for TACACS+ servers.

Use the **no** variant of this command to remove the specified server host as a TACACS+ authentication and authorization server.

Syntax `tacacs-server host {<host-name>|<ip-address>} [key [8] <key-string>]`

`no tacacs-server host {<host-name>|<ip-address>}`

Syntax (VRF-lite) `tacacs-server host {<host-name>|<ip-address>} [vrf <vrf-name>] [key [8] <key-string>]`

`no tacacs-server host {<host-name>|<ip-address>} [vrf <vrf-name>]`

Parameter	Description
<code><host-name></code>	Server host name. The DNS name of the TACACS+ server host.
<code><ip-address></code>	The IP address of the TACACS+ server host, in dotted decimal notation A.B.C.D.
<code>vrf <vrf-name></code>	The name of a VRF instance. Use this to specify the VRF that the TACACS+ server is accessible by. Servers are uniquely identified by their address and VRF, so multiple servers can have the same address or host-name as long as the VRF is different. The default is the global VRF.
<code>key</code>	Set shared secret key with TACACS+ servers.
<code>8</code>	Specifies that you are entering a password as a string that has already been encrypted instead of entering a plain text password. The running config displays the new password as an encrypted string even if password encryption is turned off.
<code><key-string></code>	Shared key string applied, a value in the range 1 to 64 characters. Specifies the shared secret authentication or encryption key for all TACACS+ communications between this device and the TACACS+ server. This key must match the encryption used on the TACACS+ server. This setting overrides the global setting of the tacacs-server key command. If no key value is specified, the global value is used.

Default No TACACS+ server is configured by default.

Mode Global Configuration

Usage A TACACS+ server host cannot be configured multiple times like a RADIUS server.

As many as four TACACS+ servers can be configured and consulted for login authentication, enable password authentication and accounting. The first server configured is regarded as the primary server and if the primary server fails then the backup servers are consulted in turn. A backup server is consulted if the primary server fails, not if a login authentication attempt is rejected. The reasons a server would fail are:

- it is not network reachable
- it is not currently TACACS+ capable
- it cannot communicate with the switch properly due to the switch and the server having different secret keys

Examples To add the server tac1.company.com as the TACACS+ server host, use the following commands:

```
awplus# configure terminal
awplus(config)# tacacs-server host tac1.company.com
```

To set the secret key to 'secret' on the TACACS+ server 192.168.1.1, use the following commands:

```
awplus# configure terminal
awplus(config)# tacacs-server host 192.168.1.1 key secret
```

To remove the TACACS+ server tac1.company.com, use the following commands:

```
awplus# configure terminal
awplus(config)# no tacacs-server host tac1.company.com
```

Examples (VRF-lite) To add the server tac1.company.com as the TACACS+ server host in the VRF named 'red', use the following commands:

```
awplus# configure terminal
awplus(config)# tacacs-server host tac1.company.com vrf red
```

To remove the TACACS+ server 192.168.1.1 from the VRF named 'red', use the following commands:

```
awplus# configure terminal
awplus(config)# no tacacs-server host 192.168.1.1 vrf red
```

Related commands

- [aaa accounting commands](#)
- [aaa authentication login](#)
- [tacacs-server key](#)
- [tacacs-server timeout](#)
- [show tacacs+](#)

Command changes Version 5.5.2-1.1: **vrf** parameter added for products that support VRF

tcpdump

Overview Use this command to start a tcpdump, which gives the same output as the Unix-like **tcpdump** command to display TCP/IP traffic. Press <ctrl> + c to stop a running tcpdump.

Syntax tcpdump <line>

Syntax (VRF-lite) tcpdump [vrf <vrf-name>] <line>

Parameter	Description
<line>	Specify the dump options. For more information on the options for this placeholder see http://www.tcpdump.org/tcpdump_man.html
vrf	Apply the command to the specified VRF instance.
<vrf-name>	The name of the VRF instance.

Mode Privileged Exec

Example To start a tcpdump running to capture IP packets, enter the command:

```
awplus# tcpdump ip
```

Example (VRF-lite) To start a tcpdump on interface vlan2 associated with a VRF instance red, enter the command:

```
awplus# tcpdump vrf red vlan2
```

Output Figure 32-26: Example output from the **tcpdump** command

```
03:40:33.221337 IP 192.168.1.1 > 224.0.0.13: PIMv2, Hello,
length: 34
1 packets captured
2 packets received by filter
0 packets dropped by kernel
```

Related commands [debug ip packet interface](#)

Command changes Version 5.4.6-2.1: VRF-lite support added.

telnet

Overview Use this command to open a telnet session to a remote device.

Syntax `telnet {<hostname>|[ip] <ipv4-addr>|[ipv6] <ipv6-addr>} [
<port>]`

Syntax (VRF-lite) `telnet [vrf <vrf-name>] {<hostname>|[ip] <ipv4-addr>|[ipv6] <ipv6-addr>} [
<port>]`

Parameter	Description
vrf	Apply this command to a VRF instance.
<vrf-name>	The name of the VRF instance.
<hostname>	The host name of the remote system.
ip	Keyword used to specify the IPv4 address or host name of a remote system.
<ipv4-addr>	An IPv4 address of the remote system.
ipv6	Keyword used to specify the IPv6 address of a remote system
<ipv6-addr>	Placeholder for an IPv6 address in the format x:x::x:x, for example, 2001:db8::8a2e:7334
<port>	Specify a TCP port number (well known ports are in the range 1-1023, registered ports are 1024-49151, and private ports are 49152-65535).

Mode User Exec and Privileged Exec

Examples To connect to TCP port 2602 on the device at 10.2.2.2, use the command:

```
awplus# telnet 10.2.2.2 2602
```

To connect to the telnet server `host.example`, use the command:

```
awplus# telnet host.example
```

To connect to the telnet server `host.example` on TCP port 100, use the command:

```
awplus# telnet host.example 100
```

Example (VRF-lite) To open a telnet session to a remote host `192.168.0.1` associated with VRF instance `red`, use the command:

```
awplus# telnet vrf red ip 192.168.0.1
```

Command changes Version 5.4.6-2.1: VRF-lite support added.

timers (RIP)

Overview Use this command to adjust routing network timers.
Use the **no** variant of this command to restore the defaults.

Syntax `timers basic <update> <timeout> <garbage>`
`no timers basic`

Parameter	Description
<code><update></code>	<code><5-2147483647></code> Specifies the period at which RIP route update packets are transmitted. The default is 30 seconds.
<code><timeout></code>	<code><5-2147483647></code> Specifies the routing information timeout timer in seconds. The default is 180 seconds. After this interval has elapsed and no updates for a route are received, the route is declared invalid.
<code><garbage></code>	<code><5-2147483647></code> Specifies the routing garbage collection timer in seconds. The default is 120 seconds.

Default Enabled

Mode RIP Router Configuration or RIP Router Address Family Configuration for a VRF instance.

Usage notes This command adjusts the RIP timing parameters.

The update timer is the time between sending out updates, that contain the complete routing table, to every neighboring router.

If an update for a given route has not been seen for the time specified by the timeout parameter, that route is no longer valid. However, it is retained in the routing table for a short time, with metric 16, so that neighbors are notified that the route has been dropped.

When the time specified by the garbage parameter expires the metric 16 route is finally removed from the routing table. Until the garbage time expires, the route is included in all updates sent by the router.

All the routers in the network must have the same timers to ensure the smooth operation of RIP throughout the network.

Examples To set the update timer to 30, the routing information timeout timer to 180, and the routing garbage collection timer to 120, use the following command:

```
awplus# configure terminal
awplus(config)# router rip
awplus(config-router)# timers basic 30 180 120
```

To set the update timer to 30, the routing information timeout timer to 180, and the routing garbage collection timer to 120 with VRF, use the following command:

```
awplus# configure terminal
awplus(config)# router rip
awplus(config-router)# address-family ipv4 vrf blue
awplus(config-router-af)# timers basic 30 180 120
```

Command changes Version 5.4.6-2.1: VRF-lite support added.

traceroute

Overview Use this command to trace the route to the specified IPv4 host.

Syntax `traceroute {<ip-addr>|<hostname>}`

Syntax (VRF-lite) `traceroute [vrf <vrf-name>] {<ip-addr>|<hostname>}`

Parameter	Description
<code><ip-addr></code>	The destination IPv4 address. The IPv4 address uses the format A.B.C.D.
<code><hostname></code>	The destination hostname.
<code>vrf</code>	Apply the command to the specified VRF instance.
<code><vrf-name></code>	The name of the VRF instance.

Mode User Exec and Privileged Exec

Example `awplus# traceroute 10.10.0.5`

Example (VRF-lite) `awplus# traceroute vrf red 192.168.0.1`

Command changes Version 5.4.6-2.1: VRF-lite support added.

version (RIP)

Overview Use this command to specify a RIP version used globally by the router.

If VRF-lite is configured, you can specify a RIP version either globally, or for a particular VRF instance.

Use the **no** variant of this command to restore the default version.

Syntax `version {1|2}`
`no version`

Parameter	Description
1 2	Specifies the version of RIP processing.

Default Version 2

Mode RIP Router Configuration or RIP Router Address Family Configuration for a VRF instance.

Usage notes RIP can be run in version 1 or version 2 mode. Version 2 has more features than version 1; in particular RIP version 2 supports authentication and classless routing. Once the RIP version is set, RIP packets of that version will be received and sent on all the RIP-enabled interfaces.

Setting the version command has no impact on receiving updates, only on sending them. The `ip rip send version` command overrides the value set by the `version (RIP)` command on an interface-specific basis. The `ip rip receive version` command allows you to configure a specific interface to accept only packets of the specified RIP version. The `ip rip receive version` command and the `ip rip send version` command override the value set by this command.

Examples To specify a RIP version, use the following commands:

```
awplus# configure terminal
awplus(config)# router rip
awplus(config-router)# version 1
```

To specify a RIP version with VRF, use the following commands:

```
awplus# configure terminal
awplus(config)# router rip
awplus(config-router)# address-family ipv4 vrf blue
awplus(config-router-af)# version 1
```

Related commands [ip rip receive version](#)
[ip rip send version](#)
[show running-config](#)

Command changes Version 5.4.6-2.1: VRF-lite support added.

vrf

Overview Use this command to add a VRF name to a DHCP server's address pool. This enables the DHCP server to become VRF-aware and allocate IP addresses which are the same as other pools.

One of the benefits of using this command is that it allows you to share DHCP leases across multiple isolated networks.

Use the **no** variant of this command to remove a VRF name from the DHCP server pool.

Syntax `vrf <vrf-name>`
`no vrf`

Parameter	Description
<vrf-name>	The name of the specific VRF instance.

Default Global VRF

Mode DHCP Configuration

Usage notes You need to enter this **vrf** command before entering the [network \(DHCP\)](#) and [range](#) address commands.

For more information, see the [DHCP Feature Overview and Configuration Guide](#).

Example To add the VRF name 'red' to the DHCP pool named 'P1', use the commands:

```
awplus# configure terminal
awplus(config)# ip dhcp pool P1
awplus(dhcp-config)# vrf red
```

To remove a VRF name from the DHCP pool named 'P1', use the commands:

```
awplus# configure terminal
awplus(config)# ip dhcp pool P1
awplus(dhcp-config)# no vrf
```

Related commands [network \(DHCP\)](#)
[range](#)
[show ip dhcp pool](#)

Command changes Version 5.5.1-1.1: command added

33

SD-WAN Commands

Introduction

Overview This chapter provides an alphabetical reference of commands used to configure SD-WAN.

For more information, see the [SD-WAN Feature Overview and Configuration Guide](#).

- Command List**
- “[application-decision](#)” on page 1731
 - “[consecutive probe loss](#)” on page 1733
 - “[debug linkmon](#)” on page 1735
 - “[destination \(linkmon-probe\)](#)” on page 1737
 - “[dscp \(linkmon-probe\)](#)” on page 1739
 - “[egress interface \(linkmon-probe\)](#)” on page 1740
 - “[enable \(linkmon-probe\)](#)” on page 1741
 - “[interval \(linkmon-probe\)](#)” on page 1742
 - “[ip policy-route](#)” on page 1743
 - “[ip-version \(linkmon-probe\)](#)” on page 1745
 - “[ipv6 policy-route](#)” on page 1746
 - “[jitter](#)” on page 1748
 - “[latency](#)” on page 1750
 - “[linkmon group](#)” on page 1752
 - “[linkmon probe-history](#)” on page 1753
 - “[linkmon probe](#)” on page 1755
 - “[linkmon profile](#)” on page 1757
 - “[load-balancing](#)” on page 1758
 - “[member \(linkmon-group\)](#)” on page 1759

- [“pktloss”](#) on page 1761
- [“preference”](#) on page 1763
- [“sample-size \(linkmon-probe\)”](#) on page 1765
- [“show debugging linkmon”](#) on page 1766
- [“show linkmon probe”](#) on page 1767
- [“show linkmon probe-history”](#) on page 1770
- [“show pbr rules”](#) on page 1772
- [“show pbr rules brief”](#) on page 1777
- [“size \(linkmon-probe\)”](#) on page 1779
- [“source \(linkmon-probe\)”](#) on page 1780
- [“url \(linkmon-probe\)”](#) on page 1781

application-decision

Overview Use this command to select which method is used for the application decision.

Syntax `application-decision {once-only|continuous}`

Parameter	Description
<code>once-only</code>	When a traffic flow reaches the PBR engine for the first time, whatever application has been set on that flow will be used to match against the PBR rules and a route selected. Subsequent updates to the flow's application will be ignored by the PBR engine.
<code>continuous</code>	Any time a traffic flow has its application updated by the DPI engine, the PBR engine will re-process the flow against all configured PBR rules, which may result in a new match and the traffic being directed over a different route than it was previously.

Default Application determination is set to **continuous**.

Mode Policy-based Routing Configuration

Usage notes When using a DPI engine, traffic flows through the device are periodically assigned an application by the DPI engine. The application assignment is then used when matching against PBR rules. The DPI engine may change its decision about a traffic flow over time, as more packets from the flow are analyzed. This command determines how the PBR engine utilizes the application decision made by DPI.

When set to **once-only**, only the initial application decision made by the DPI engine will be used when matching against PBR routes, and subsequent updates will be ignored.

When set to **continuous**, if the DPI engine re-classifies a traffic flow under a different application, the flow will be re-processed by the PBR engine, and may therefore match against a different PBR rule and take a different route than it was previously.

Once-only is intended for use with DPI learning enabled. Refer to the [SD-WAN Feature Overview and Configuration Guide](#) for examples.

Example To prevent the PBR engine from re-matching a traffic flow whenever the application decision is changed, use the following commands:

```
awplus(config)# policy-based-routing
awplus(config-pbr)# application-decision once-only
```

To allow the PBR engine to re-match traffic flows against PBR rules when the application decision changes, use the following commands:

```
awplus(config)# policy-based-routing
awplus(config-pbr)# application-decision continuous
```

Related commands `ip policy-route`
`ipv6 policy-route`

Command changes Version 5.4.8-0.2: command added

consecutive probe loss

Overview Use this command within a specific link performance profile to configure the allowable consecutive probe loss thresholds of probes that use that performance profile.

Use the **no** variant of this command to delete a consecutive probe loss threshold.

Syntax consecutive-probe-loss bad-when <consecutive-probe-losses>
consecutive-probe-loss good-when <consecutive-probe-successes>
consecutive-probe-loss unreachable-when
<consecutive-probe-losses>
no consecutive-probe-loss bad-when
no consecutive-probe-loss good-when
no consecutive-probe-loss unreachable-when

Parameter	Description
bad-when <consecutive-probe-losses>	The number of probes that must be lost consecutively, at which point the associated link is considered to be bad, in a range of <1-100>.
good-when <consecutive-probe-successes>	The number of probes that must succeed consecutively, at which point the associated link is considered to be good, in a range of <1-100>.
unreachable-when <consecutive-probe-losses>	The number of probes that must be lost consecutively, at which point the associated link is considered to be unreachable, in a range of <1-100>.

Default The performance profile is disabled.

Mode Linkmon Profile Configuration

Usage notes These setting are all optional.

The **bad-when** parameter is used to set the thresholds where if the number of probe replies that have been lost consecutively is equal to or above this value, then that nexthop is considered bad. If **bad-when** is not configured, this metric will never result in a nexthop being considered bad.

The **unreachable-when** parameter is used to set the thresholds where if the number of probe replies that have been lost consecutively is equal to or above this value, then that nexthop is considered unreachable or down. If **unreachable-when** is not configured, this metric will never result in a nexthop being considered unreachable.

The **good-when** parameter is used to state the thresholds where if the number of probe replies that have been successfully received consecutively is equal to or above this value, then that nexthop is considered good. If **good-when** is not

configured, then when a nexthop is considered bad or unreachable due to this metric, the first successful probe result will consider the nexthop as good.

Example To configure the point at or above which consecutive probe loss is unacceptable to be 10, the point at or above which consecutive probe success is acceptable to be 5, and the point at or above which consecutive probe loss indicates the destination is unreachable to be 15 for performance profile named "profile0", use the following commands:

```
awplus# configure terminal
awplus(config)# linkmon profile profile0
awplus(config-linkmon-profile)# consecutive-probe-loss
bad-when 10
awplus(config-linkmon-profile)# consecutive-probe-loss
good-when 5
awplus(config-linkmon-profile)# consecutive-probe-loss
unreachable-when 15
```

To delete consecutive-probe-loss thresholds in performance profile "profile0", use the following commands:

```
awplus# configure terminal
awplus(config)# linkmon profile profile0
awplus(config-linkmon-profile)# no consecutive-probe-loss
bad-when
awplus(config-linkmon-profile)# no consecutive-probe-loss
good-when
awplus(config-linkmon-profile)# no consecutive-probe-loss
unreachable-when
```

**Command
changes**

Version 5.4.8-1.1: command added

Version 5.5.1-0.1: command added to all AlliedWare Plus switches

debug linkmon

Overview Use this command to enable Link Health Monitoring debugging.
Use the **no** variant of this command to disable Link Health Monitoring debugging.

Syntax

```
debug linkmon  
[probe|group|ip-address|interface|pbr-group|trigger]  
  
no debug linkmon  
[probe|group|ip-address|interface|pbr-group|trigger]  
  
debug linkmon probe name <name>  
  
no debug linkmon probe name <name>  
  
debug linkmon group name <name>  
  
no debug linkmon group name <name>
```

Parameter	Description
probe	Link Health Monitoring probe.
group	Link Health Monitoring group.
ip-address	IP addresses that are of interest to Link Health Monitoring.
interface	Interfaces that are of interest to Link Health Monitoring.
pbr-group	This debug option will show debugging of policy-based routing Link Health Monitoring groups. Policy-based routing rules without an explicit Link Health Monitoring configuration will internally create Link Health Monitoring groups that are not visible from the Link Health Monitoring api/cli externally (apart from debug). The names for these groups are prefixed with 'pbr'. Their relationship to policy-based routing rules can be seen with policy-based routing debug enabled.
trigger	This debug option will show debugging for Link Health Monitoring triggers.
<name>	The name identifying a Link Health Monitoring probe or Link Health Monitoring group.

Default No debugging is enabled.

Mode Privileged Exec

Usage notes If **probe** is specified, then debug related to all Link Health Monitoring probes is enabled.

If **probe name <name>** is specified, then debug related to the named Link Health Monitoring probe is enabled.

If **group** is specified, then debug related to all Link Health Monitoring groups is enabled.

If **group name** <name> is specified, then debug related to the named Link Health Monitoring group is enabled.

If **ip-address** is specified, then debug related to configuration of IP addresses that are of interest to Link Health Monitoring are enabled. These IP addresses could influence Link Health Monitoring group members being considered up/down.

If **interface** is specified, then debug related to up/down state of Link Health Monitoring is enabled.

If **trigger** is specified, then debug related to Link Health Monitoring triggers is enabled.

Example To enable debugging on the Link Health Monitoring probe 'probe1', use the following command:

```
awplus# debug linkmon probe name probe1
```

To enable debugging on all Link Health Monitoring probes, use the following command:

```
awplus# debug linkmon probe
```

To enable debugging on all Link Health Monitoring groups, use the following command:

```
awplus# debug linkmon group
```

To disable debugging on all Link Health Monitoring probes, use the following command:

```
awplus# no debug linkmon probe
```

To disable debugging on all Link Health Monitoring groups, use the following command:

```
awplus# no debug linkmon group
```

Related commands [linkmon probe](#)
[show debugging linkmon](#)

Command changes Version 5.4.8-0.2: command added
Version 5.5.1-0.1: command added to all AlliedWare Plus switches

destination (linkmon-probe)

Overview Use this command to set the destination of a Link Health Monitoring probe. This is a required configuration option for probes.

Use the **no** variant of this command to remove the destination of a probe.

Syntax `destination {<ip-address>|ds-lite|<fqdn>}`
`no destination`

Parameter	Description
<code><ip-address></code>	The destination of the probe, an IPv4 or IPv6 IP address.
<code>ds-lite</code>	The destination of the probe, the DS-Lite AFTR address.
<code><fqdn></code>	The destination of the probe, an FQDN (fully qualified domain name). The IP address of the FQDN will be automatically resolved by the DNS on the device.

Mode Linkmon ICMP Probe Configuration

Example To set the destination of a probe named 'probe1' to 192.168.2.200, use the following commands:

```
awplus(config)# linkmon probe name probe1  
awplus(config-linkmon-icmp-probe)# destination 192.168.2.200
```

To set the destination of a probe named 'probe1' to 2001:db8:a0b:12f0::1, use the following commands:

```
awplus(config)# linkmon probe name probe1  
awplus(config-linkmon-icmp-probe)# destination  
2001:db8:a0b:12f0::1
```

To set the destination of a probe named 'probe1' to the DS-Lite AFTR address, use the following commands:

```
awplus(config)# linkmon probe name probe1  
awplus(config-linkmon-icmp-probe)# destination ds-lite
```

To set the destination of a probe named 'probe1' to the FQDN of "google.com", use the following commands:

```
awplus(config)# linkmon probe name probe1  
awplus(config-linkmon-icmp-probe)# destination google.com
```

To remove the destination of a probe named 'probe1', use the following commands:

```
awplus(config)# linkmon probe name probe1  
awplus(config-linkmon-icmp-probe)# no destination
```

Related commands [linkmon probe](#)

Command changes Version 5.4.8-1.1: command added
Version 5.5.1-0.1: command added to all AlliedWare Plus switches

dscp (linkmon-probe)

Overview Use this command to set the DSCP value of packets used for Link Health Monitoring probes.

Use the **no** variant of this command to set it back to the default.

Syntax `dscp <dscp-value>`
`no dscp`

Parameter	Description
<code><dscp-value></code>	The DSCP value for the probe packet in range <0-63>.

Default The default DSCP value is 0.

Mode Linkmon ICMP Probe Configuration

Example To set the DSCP of a probe named 'probe1' to 10, use the following commands:

```
awplus(config)# linkmon probe name probe1  
awplus(config-linkmon-icmp-probe)# dscp 10
```

To set the DSCP of a probe named 'probe1' back to default, use the following commands:

```
awplus(config)# linkmon probe name probe1  
awplus(config-linkmon-icmp-probe)# no dscp
```

Related commands [linkmon probe](#)

Command changes Version 5.4.8-1.1: command added

Version 5.5.1-0.1: command added to all AlliedWare Plus switches

egress interface (linkmon-probe)

Overview Use this command to force a Link Health Monitoring probe to egress out of a specific interface.

Use the **no** variant of this command to return interface selection back to the default behavior.

Syntax `egress interface <interface>`
`no egress interface`

Parameter	Description
<code><interface></code>	The name of the egress interface for the probe. The specified egress interface needs to be locally configured and in an up and running state.

Default No egress interface is defined by default. The egress interface will be selected using standard routing behavior to reach the probe's destination.

Mode Linkmon HTTP Probe Configuration, or Linkmon ICMP Probe Configuration

Example To set the egress interface for a probe named 'probe1' to 'tunnel2', use the following commands:

```
awplus(config)# linkmon probe name probe1  
awplus(config-linkmon-icmp-probe)# egress interface tunnel2
```

To set the egress interface for a probe named 'probe1' back to the default, use the following commands:

```
awplus(config)# linkmon probe name probe1  
awplus(config-linkmon-icmp-probe)# no egress interface
```

Command changes Version 5.4.8-1.1: command added

Version 5.5.1-0.1: command added to all AlliedWare Plus switches

enable (linkmon-probe)

Overview Use this command to enable individual Link Health Monitoring probes. When a probe is enabled, it will begin transmitting, processing, and storing results.

Use the **no** variant of this command to disable a probe.

Syntax enable
no enable

Default Disabled

Mode Linkmon HTTP Probe Configuration, or Linkmon ICMP Probe Configuration

Example To enable a probe named 'probe1', use the following commands:

```
awplus(config)# linkmon probe name probe1  
awplus(config-linkmon-icmp-probe)# enable
```

To disable a probe named 'probe1', use the following commands:

```
awplus(config)# linkmon probe name probe1  
awplus(config-linkmon-icmp-probe)# no enable
```

Related commands [linkmon probe](#)

Command changes Version 5.4.8-1.1: command added
Version 5.5.1-0.1: command added to all AlliedWare Plus switches

interval (linkmon-probe)

Overview Use this command to set the interval between Link Health Monitoring probe packets.

Use the **no** variant of this command to set the interval back to the default.

Syntax `interval <probe-interval>`
`no interval`

Parameter	Description
<code><probe-interval></code>	The gap between probes being transmitted. For ICMP probes, this is a range of 100-10000 milliseconds. For HTTP probes, this is a range of 30000-3600000 milliseconds.

Default For ICMP probes, the default interval is 1000 milliseconds. For HTTP probes, the default interval is 60000 milliseconds.

Mode Linkmon HTTP Probe Configuration, or Linkmon ICMP Probe Configuration

Example To set the interval of a probe named 'probe1' to 100, use the following commands:

```
awplus(config)# linkmon probe name probe1  
awplus(config-linkmon-icmp-probe)# interval 100
```

To set the interval of a probe named 'probe1' back to default, use the following commands:

```
awplus(config)# linkmon probe name probe1  
awplus(config-linkmon-icmp-probe)# no interval
```

Related commands [linkmon probe](#)

Command changes Version 5.4.8-1.1: command added

Version 5.5.1-0.1: command added to all AlliedWare Plus switches

ip policy-route

Overview Use this command to configure IP policy routes. These routes specify how the device will route traffic from specified applications and entities. You can specify the route's next-hop by specifying the egress interface, or by specifying the next-hop device's IP address (except on dynamic interfaces such as PPPoE). You can also list alternative next-hops to use if your first choice is down.

You can also specify the pseudo interface Null. Null should be the last nexthop specified, as this will drop packets when used as the nexthop.

Use the **no** variant of this command to remove a policy route.

Syntax

```
ip policy-route [<1-500>] [match <application-name>] [from  
<source-entity>] [to <destination-entity>] nexthop  
{<interface-list>|<ip-add-list>}  
  
no ip policy-route <1-500>
```

Parameter	Description
<1-500>	The policy route ID number. If you do not specify an ID number, the device assigns the new policy route the next available number, in multiples of 10. For example, if the highest numbered policy route is 81, the next policy route would be given an ID of 90. Policy routes are checked in order of ID number, starting with the lowest ID number. The device applies the policy route as soon as it finds a matching route; it does not check the remaining policy routes.
<application-name>	An application name. You can use the tab key to auto-complete application names.
<source-entity>	A source entity name. You can use the tab key to auto-complete entity names.
<destination-entity>	A destination entity name.
<interface-list>	The name of the egress interface or interfaces. You can list up to 8 interfaces per policy route; the device sends the traffic out the first interface in the list that is up.
<ip-add-list>	The IP address of the next-hop. You can list up to 8 next-hop addresses per policy route; the device sends the traffic to the first address in the list that is reachable. Do not use this when the next-hop is on a dynamic interface (e.g. PPPoE); specify the interface name instead.

Default No policy routes

Mode Policy-based Routing Configuration

Usage notes You must specify at least one of the **match**, **from** or **to** parameters. Packets will be routed to the specified next-hop if they match the application, come from the source entity, and are destined for the destination entity.

Before creating a policy route, you need to create the application and entities that specify the traffic you want to route. To create an application, use the [application](#) command. To create entities, use the [zone](#), [network \(zone\)](#), and [host \(network\)](#) commands. To see existing applications and entities, use the [show application](#) and [show entity](#) commands.

Examples To create a policy route to route traffic that matches an application called 'voice', comes from the entity called 'inside', and is destined for the entity called 'outside', use the following commands:

```
awplus# configure terminal
awplus(config)# policy-based-routing
awplus(config-pbr)# policy-based-routing enable
awplus(config-pbr)# ip policy-route 10 match voice from inside
to outside nexthop 10.37.236.65
```

To delete the policy route created above, use the following commands:

```
awplus# configure terminal
awplus(config)# policy-based-routing
awplus(config-pbr)# no ip policy-route 10
```

To route the above traffic via ppp0 if ppp0 is up, or ppp1 if ppp0 is down, use the following commands:

```
awplus# configure terminal
awplus(config)# policy-based-routing
awplus(config-pbr)# policy-based-routing enable
awplus(config-pbr)# ip policy-route 20 match voice from inside
to outside nexthop ppp0 ppp1
```

To delete the policy route created above, use the following commands:

```
awplus# configure terminal
awplus(config)# policy-based-routing
awplus(config-pbr)# no ip policy-route 20
```

Related commands

- [policy-based-routing](#)
- [policy-based-routing enable](#)
- [show application](#)
- [show entity](#)
- [show ip pbr route](#)

Command changes Version 5.4.8-0.2: number of routes increased, null interface added

ip-version (linkmon-probe)

Overview Use this command to set the IP version for the Link Health Monitoring ICMP probe. Use the **no** variant of this command to set it back to the default.

Syntax `ip-version {4|6}`
`no ip-version`

Parameter	Description
4	Internet Protocol (IPv4)
6	Internet Protocol version 6 (IPv6)

Default IPv4

Mode Linkmon HTTP Probe Configuration, or Linkmon ICMP Probe Configuration

Example To set the IP version as IPv6 for a probe named 'probe1', use the following commands:

```
awplus(config)# linkmon probe name probe1  
awplus(config-linkmon-icmp-probe)# ip-version 6
```

To set the IP version back to the default for a probe named 'probe1', use the following commands:

```
awplus(config)# linkmon probe name probe1  
awplus(config-linkmon-icmp-probe)# no ip-version
```

Command changes Version 5.4.8-1.1: command added
Version 5.5.1-0.1: command added to all AlliedWare Plus switches

ipv6 policy-route

Overview Use this command to configure IPv6 policy routes. These routes specify how the device will route traffic from specified applications and entities. You can specify the route's next-hop by specifying the egress interface, or by specifying the next-hop device's IPv6 address (except on dynamic interfaces such as PPPoE). You can also list alternative next-hops to use if your first choice is down.

You can also specify the pseudo interface Null. Null should be the last nexthop specified, as this will drop packets when used as the nexthop.

Use the **no** variant of this command to remove a policy route.

Syntax

```
ipv6 policy-route [<1-500>] [match <application-name>] [from  
<source-entity>] [to <destination-entity>] nexthop  
{<interface-list>|<ipv6-add-list>}  
  
no ipv6 policy-route <1-500>
```

Parameter	Description
<1-500>	The policy route ID number. If you do not specify an ID number, the device assigns the new policy route the next available number, in multiples of 10. For example, if the highest numbered policy route is 81, the next policy route would be given an ID of 90. Policy routes are checked in order of ID number, starting with the lowest ID number. The device applies the policy route as soon as it finds a matching route; it does not check the remaining policy routes.
<application-name>	An application name. You can use the tab key to auto-complete application names.
<source-entity>	A source entity name. You can use the tab key to auto-complete entity names.
<destination-entity>	A destination entity name.
<interface-list>	The name of the egress interface or interfaces. You can list up to 8 interfaces per policy route; the device sends the traffic out the first interface in the list that is up.
<ipv6-add-list>	The IPv6 address of the next-hop, specified in the form X:X::X:X. You can list up to 8 next-hop addresses per policy route; the device sends the traffic to the first address in the list that is reachable. Do not use this when the next-hop is on a dynamic interface (e.g. PPPoE); specify the interface name instead.

Default No policy routes

Mode Policy-based Routing Configuration

Usage notes You must specify at least one of the **match**, **from** or **to** parameters. Packets will be routed to the specified next-hop if they match the application, come from the source entity, and are destined for the destination entity.

Before creating a policy route, you need to create the application and entities that specify the traffic you want to route. To create an application, use the [application](#) command. To create entities, use the [zone](#), [network \(zone\)](#), and [host \(network\)](#) commands. To see existing applications and entities, use the [show application](#) and [show entity](#) commands.

Examples To create a policy route to route traffic that matches an application called 'voice', comes from the entity called 'inside', and is destined for the entity called 'outside', use the following commands:

```
awplus# configure terminal
awplus(config)# policy-based-routing
awplus(config-pbr)# policy-based-routing enable
awplus(config-pbr)# ipv6 policy-route 10 match voice from
inside to outside nexthop 2001:100::1
```

To delete the policy route created above, use the following commands:

```
awplus# configure terminal
awplus(config)# policy-based-routing
awplus(config-pbr)# no ipv6 policy-route 10
```

To route the above traffic via ppp0 if ppp0 is up, or ppp1 if ppp0 is down, use the following commands:

```
awplus# configure terminal
awplus(config)# policy-based-routing
awplus(config-pbr)# policy-based-routing enable
awplus(config-pbr)# ipv6 policy-route 20 match voice from
inside to outside nexthop ppp0 ppp1
```

To delete the policy route created above, use the following commands:

```
awplus# configure terminal
awplus(config)# policy-based-routing
awplus(config-pbr)# no ipv6 policy-route 20
```

Related commands

- [policy-based-routing](#)
- [policy-based-routing enable](#)
- [show application](#)
- [show entity](#)
- [show ipv6 pbr route](#)

Command changes Version 5.4.8-0.2: number of routes increased, null interface added

jitter

Overview Use this command to configure the thresholds for the jitter metric. This metric is used to judge whether probes associated with this performance profile are good or bad.

Use the **no** variant of this command to remove jitter bad-above and jitter good-below ranges.

Syntax jitter bad-above <unacceptable-jitter-point>
jitter good-below <acceptable-jitter-point>
no jitter bad-above
no jitter good-below

Parameter	Description
bad-above <unacceptable-jitter-point>	The point above which jitter is unacceptable in range <1-1000> in milliseconds. When a probe associated with this profile has a jitter result greater than this value, the associated Link Health Monitoring member will be considered 'bad'.
good-below <acceptable-jitter-point>	The point at or below which jitter is acceptable in range <1-1000> in milliseconds. When a probe associated with this profile has a jitter result less than this value, the associated Link Health Monitoring member will be considered 'good'.

Mode Linkmon Profile Configuration

Usage notes If only **bad-above** is configured, then if the probe results indicate a nexthop is above this value, then that nexthop is considered bad. As soon as the results fall below this value, the nexthop will be immediately considered good.

The combination of these two parameters allow for hysteresis, which may prevent link-flapping behavior. For example, with a **bad-above** value of 100, and a **good-below** value of 90, if the jitter rises to 100 the link will be marked 'bad', but it will not be marked 'good' until it reaches or falls below 90.

If only **good-below** is configured, then probe results will not cause a nexthop to be considered bad.

Example To configure the point above which jitter is unacceptable to be 100ms and the point at or below which jitter is acceptable to be 90ms for a performance profile named 'profile1', use the following commands:

```
awplus(config)# linkmon profile profile1  
awplus(config-linkmon-profile)# jitter bad-above 100  
awplus(config-linkmon-profile)# jitter good-below 90
```

To delete the jitter ranges for a performance profile named 'profile1', use the following commands:

```
awplus(config)# linkmon profile profile1  
awplus(config-linkmon-profile)# no jitter bad-above  
awplus(config-linkmon-profile)# no jitter good-below
```

**Related
commands**

[ip policy-route](#)
[latency](#)
[member \(linkmon-group\)](#)
[linkmon probe](#)
[linkmon profile](#)
[pktloss](#)
[preference](#)

**Command
changes**

Version 5.4.8-0.2: command added
Version 5.5.1-0.1: command added to all AlliedWare Plus switches

latency

Overview Use this command to configure the thresholds for the latency metric. This metric is used to judge whether probes associated with this performance profile are good or bad.

Use the **no** variant of this command to remove latency bad-above and latency good-below ranges.

Syntax `latency bad-above <unacceptable-latency-point>`
`latency good-below <acceptable-latency-point>`
`no latency bad-above`
`no latency good-below`

Parameter	Description
<code>bad-above</code> <code><unacceptable-</code> <code>latency-point></code>	The point above which latency is unacceptable in range <code><1-2000></code> in milliseconds. When a probe associated with this profile has a latency result greater than this value, the associated Link Health Monitoring member will be considered 'bad'.
<code>good-below</code> <code><acceptable-</code> <code>latency-point></code>	The point at or below which latency is acceptable in range <code><1-2000></code> in milliseconds. When a probe associated with this profile has a latency result less than this value, the associated Link Health Monitoring member will be considered 'good'.

Mode Linkmon Profile Configuration

Usage notes If only **bad-above** is configured, then if the probe results indicate a nexthop is above this value, then that nexthop is considered bad. As soon as the results fall below this value, the nexthop will be immediately considered good.

The combination of these two parameters allow for hysteresis, which may prevent link-flapping behavior. For example, with a **bad-above** value of 100, and a **good-below** value of 90, if the latency rises to 100 the link will be marked 'bad', but it will not be marked 'good' until it reaches or falls below 90.

If only **good-below** is configured, then probe results will not cause a nexthop to be considered bad.

Example To configure the point above which latency is unacceptable to be 100ms and the point at or below which latency is acceptable to be 90ms for a performance profile named 'profile1', use the following commands:

```
awplus(config)# linkmon profile profile1
awplus(config-linkmon-profile)# latency bad-above 100
awplus(config-linkmon-profile)# latency good-below 90
```

To delete the latency ranges for a performance profile named 'profile1', use the following commands:

```
awplus(config)# linkmon profile profile1  
awplus(config-linkmon-profile)# no latency bad-above  
awplus(config-linkmon-profile)# no latency good-below
```

**Related
commands**

[ip policy-route](#)
[jitter](#)
[member \(linkmon-group\)](#)
[linkmon probe](#)
[linkmon profile](#)
[pktloss](#)
[preference](#)

**Command
changes**

Version 5.4.8-0.2: command added
Version 5.5.1-0.1: command added to all AlliedWare Plus switches

linkmon group

Overview Use this command to create a Link Health Monitoring group and enter Linkmon Group Configuration mode where this group can be configured.

Use the **no** variant of this command to remove a configured group. All members previously belonging to the group are also removed.

Syntax `linkmon group <group-name>`
`no linkmon group <group-name>`

Parameter	Description
<code><group-name></code>	The name of the link monitoring group.

Mode Global Configuration

Example To create a new link monitoring group named 'group1', use the following commands:

```
awplus# configure terminal
awplus(config)# linkmon group group1
awplus(config-linkmon-group)#
```

To remove a link monitoring group named 'group1', use the following commands:

```
awplus# configure terminal
awplus(config)# no linkmon group group1
```

Related commands

- [ip policy-route](#)
- [jitter](#)
- [latency](#)
- [linkmon probe](#)
- [linkmon profile](#)
- [load-balancing](#)
- [member \(linkmon-group\)](#)
- [pktloss](#)
- [preference](#)
- [show linkmon probe](#)

Command changes Version 5.4.8-1.1: command added

linkmon probe-history

Overview Use this command to create a collection instance that records the metrics gathered by a Link Health Monitoring probe.

Use the **no** variant of this command to remove the specified collection instance.

Syntax linkmon probe-history [*<1-65535>*] probe *<probe-name>* interval *<1-2678400>* buckets *<1-65535>*
no linkmon probe-history *<1-65535>*

Parameter	Description
probe-history <i><1-65535></i>	The ID of the probe history collection instance. If this is not set on creation then it will be automatically allocated.
probe <i><probe-name></i>	The name of the probe to record metrics for.
interval <i><1-2678400></i>	The interval that metrics are collated, in seconds.
buckets <i><1-65535></i>	The maximum number of metric history samples.

Mode Global Configuration

Usage notes Metrics are collated every **interval** seconds. Up to **buckets** samples of metrics are collated.

Different **interval** and **buckets** values can be used to record specific kinds of histories. For example, an **interval** value of 1 and a **buckets** value of 3600 would record per second metrics of a probe for an hour. An **interval** value of 3600 and a **buckets** value of 744 would record per hour metrics of a probe for 31 days.

Using the Web API, metric values for a sample are returned as a sum and a count. The sum can be divided by the count for an average. For example, if 10 probes have been sent during a history interval, then the metric counts would be 10 for a sample, and the sum would be the total of the metric values.

If a probe receives no reply then no metric is recorded.

Packet loss is not recorded exactly. Instead the probes sent and probe replies received is recorded.

CAUTION: This configuration option can consume a large amount of RAM on the device, particularly if high numbers of buckets are configured. The memory is reserved when the command is entered, so if the memory consumption from this command exhausts the system memory causing a reboot, you will discover this at configuration time.

Example To create a Link Health Monitoring probe history collection instance with an ID of 10 for a probe named 'probe1' that collates metrics every second while keeping up to 300 samples, use the following command:

```
awplus# configure terminal
awplus(config)# linkmon probe-history 10 probe probe1 interval
1 buckets 300
```

To create a Link Health Monitoring probe history collection instance with an automatically allocated ID for a probe named 'probe1' that collates metrics every 60 seconds while keeping up to 3600 samples, use the following command:

```
awplus# configure terminal
awplus(config)# linkmon probe-history probe probe1 interval 60
buckets 3600
```

Related commands [linkmon probe](#)

Command changes Version 5.4.8-0.2: command added
Version 5.5.1-0.1: command added to all AlliedWare Plus switches

linkmon probe

Overview Use this command to create a Link Health Monitoring probe and enter the appropriate Link Health Monitoring Probe Configuration Mode where this probe can be configured.

Use the **no** variant of this command to delete the Link Health Monitoring probe.

Syntax `linkmon probe name <probe-name> [type {icmp-ping|http-get}]`
`no linkmon probe name <probe-name>`

Parameter	Description
<code><probe-name></code>	The name of the probe.
<code>type</code>	The type of the probe. Indicates the packet type or protocol used by the probe, either of icmp-ping (ICMP) or http-get (HTTP). This parameter is optional. If not entered, a newly created probe's type defaults to icmp-ping .

Default The default probe type for a newly created probe is **icmp-ping**. The optional parameter **type** is only required to create a probe type other than the default. The **type** parameter is not required when editing an existing probe or deleting a probe.

Mode Global Configuration

Usage notes The optional probe **type** parameter represents the packet type or protocol used in the transmission of the probe. A probe of type **icmp-ping** will present some different configuration options to a probe of type **http-get**.

An **icmp-ping** Link Health Monitoring probe requires a destination, and must be enabled for probing to begin.

An **http-get** Link Health Monitoring probe requires a URL, and must be enabled for probing to begin.

Example To create a probe named 'probe1' using the default probe type and enter Link Health Monitoring ICMP Probe Configuration Mode to configure it, use the following commands:

```
awplus# configure terminal
awplus(config)# linkmon probe name probe1
awplus(config-linkmon-icmp-probe)#
```

To create a probe named 'probe1' using the default ICMP probe type and enter Link Health Monitoring ICMP Probe Configuration Mode to configure it, use the following commands:

```
awplus# configure terminal
awplus(config)# linkmon probe name probe1 type icmp-ping
awplus(config-linkmon-icmp-probe)#
```

To create a probe named 'probe1' using the HTTP probe type and enter Link Health Monitoring HTTP Probe Configuration Mode to configure it, use the following commands:

```
awplus# configure terminal
awplus(config)# linkmon probe name probe1 http-probe
awplus(config-linkmon-http-probe)#
```

To remove a probe named 'probe1', use the following commands:

```
awplus# configure terminal
awplus(config)# no linkmon probe name probe1
```

**Related
commands**

[enable \(linkmon-probe\)](#)
[interval \(linkmon-probe\)](#)
[ip policy-route](#)
[jitter](#)
[latency](#)
[linkmon probe-history](#)
[linkmon profile](#)
[member \(linkmon-group\)](#)
[pktloss](#)
[preference](#)
[show linkmon probe](#)
[show linkmon probe-history](#)
[size \(linkmon-probe\)](#)

**Command
changes**

Version 5.4.8-0.2: command added
Version 5.4.8-1.1: now operates as a modal command, with the new type parameter used to determine whether to enter ICMP or HTTP probe mode
Version 5.5.1-0.1: command added to all AlliedWare Plus switches

linkmon profile

Overview Use this command to create a Link Health Monitoring performance profile and enter Linkmon Profile Configuration mode where this profile can be configured. Use the **no** variant of this command to remove a configured performance profile.

Syntax `linkmon profile <profile-name>`
`no linkmon profile <profile-name>`

Parameter	Description
<code><profile-name></code>	The name of the performance profile.

Mode Global Configuration

Example To create a new performance profile named 'profile1', use the following commands:

```
awplus# configure terminal
awplus(config)# linkmon profile profile1
awplus(config-linkmon-profile)#
```

To remove a performance profile named 'profile1', use the following commands:

```
awplus# configure terminal
awplus(config)# no linkmon profile profile1
```

Related commands

- [ip policy-route](#)
- [jitter](#)
- [latency](#)
- [linkmon probe](#)
- [member \(linkmon-group\)](#)
- [pktloss](#)
- [preference](#)
- [show linkmon probe](#)

Command changes Version 5.4.8-0.2: command added
Version 5.5.1-0.1: command added to all AlliedWare Plus switches

load-balancing

Overview Use this command to enable load-balancing for a Link Health Monitoring group. Use the **no** variant of this command to remove load-balancing from a Link Health Monitoring group.

Syntax `load-balancing`
`no load-balancing`

Default Load-balancing is disabled.

Mode Linkmon Group Configuration

Usage notes When load-balancing is enabled, traffic will be load-balanced across all valid nexthops.

Load-balancing is achieved using a hashing algorithm on a per-flow basis for each application. For example, if two users visit YouTube, the session for user 1 may be sent over Tunnel 1, and the session for user 2 may be sent over Tunnel 2. Packets from each session will be sent entirely within one tunnel, until that session ends.

When a Link Health Monitoring group is configured for load-balancing, the preferred-metric used in any profile that is combined with the group in a PBR rule will be ignored when selecting 'good' links to send traffic over. This is because when load-balancing is enabled, all links that are 'good' are selected to send traffic over, so preferred metric is not required for tie-breaking. The preferred-metric is still used when all links within a group are considered 'bad' by a profile, in which case the least-bad link according to the preferred metric will be selected as the single link to send traffic over.

Example To enable load-balancing on the Link Health Monitoring group "BranchOffice", use the following commands:

```
awplus# configure terminal
awplus(config)# linkmon group BranchOffice
awplus(config-linkmon-group)# load-balancing
```

To disable load-balancing on the Link Health Monitoring group "BranchOffice", use the following commands:

```
awplus# configure terminal
awplus(config)# linkmon group BranchOffice
awplus(config-linkmon-group)# no load-balancing
```

Related commands [linkmon group](#)

Command changes Version 5.4.8-1.1: command added

member (linkmon-group)

Overview Use this command to create a link monitoring group member and specify its nexthop destination and the probe to be used to gather metrics to judge the health of this member. A maximum of 8 members can be created per group.

Use the **no** variant of this command to remove a group member. The member ID is mandatory upon deletion.

Syntax `member [<member-id>] destination <ip-address>|<interface> probe <probe-name>`
`no member <member-id>`

Parameter	Description
<member-id>	The ID of the link monitoring group member, a number in range <1-128>.
destination	The nexthop destination of the member that traffic will be directed to when this member is judged as the best available within the group, according the probe metric results and PBR rule profile.
<ip-address>	The IPv4 or IPv6 IP address of the next-hop. Do not use this when the next-hop is on a dynamic interface (e.g. PPPoE); specify the interface name instead.
<interface>	The name of the egress interface of the next-hop.
<probe-name>	The name of an existing probe.

Mode Linkmon Group Configuration

Usage notes Users can also optionally specify a group member ID. If no ID is specified, a unique ID will be automatically created and assigned to the group member.

The pseudo interface Null can be specified as a nexthop. This acts as an always up but bad interface. This is to be chosen as the best member when all other members are unavailable. No probe needs to be specified for this type of member.

Example To create a new group member in group 'group1' using probe 'probe1' with ID 10 and destination 'tunnel1', use the following commands:

```
awplus# configure terminal
awplus(config)# linkmon group group1
awplus(config-linkmon-group)# member 10 destination tunnel1
probe probe1
```

To delete the group member with member ID '10' in group 'group1', use the following commands:

```
awplus# configure terminal
awplus(config)# linkmon group group1
awplus(config-linkmon-group)# no member 10
```

**Related
commands**

[ip policy-route](#)
[member \(linkmon-group\)](#)
[linkmon profile](#)
[linkmon probe](#)
[show linkmon probe](#)

**Command
changes**

Version 5.4.8-0.2: command added

pktloss

Overview Use this command to configure the thresholds for the packet loss metric. This metric is used to judge whether probes associated with this performance profile are good or bad.

Use the **no** variant of this command to remove packet loss rate bad-above and packet loss rate good-below ranges.

Syntax

```
pktloss bad-above <unacceptable-pktloss-point>
pktloss good-below <acceptable-pktloss-point>
no pktloss bad-above
no pktloss good-below
```

Parameter	Description
<i><unacceptable-pktloss-point></i>	The point above which packet loss rate is unacceptable in range <i><0.0-100.0></i> in percent to one decimal place. When a probe associated with this profile has a packet loss rate result greater than this value, the associated Link Health Monitoring member will be considered 'bad'.
<i><acceptable-pktloss-point></i>	The point at or below which packet loss rate is acceptable in range <i><0.0-100.0></i> in percent to one decimal place. When a probe associated with this profile has a packet loss rate result less than this value, the associated Link Health Monitoring member will be considered 'good'.

Mode Linkmon Profile Configuration

Usage notes If only **bad-above** is configured, then if the probe results indicate a nexthop is above this value, then that nexthop is considered bad. As soon as the results fall below this value, the nexthop will be immediately considered good.

The combination of these two parameters allow for hysteresis, which may prevent link-flapping behavior. For example, with a **bad-above** value of 5, and a **good-below** value of 3, if the packet loss rises to 5 the link will be marked 'bad', but it will not be marked 'good' until it reaches or falls below 3.

If only **good-below** is configured, then probe results will not cause a nexthop to be considered bad.

Packet loss also has a built-in threshold, where when it reaches 100% packet loss, the associated member is automatically considered unreachable / down, and will never be used as a nexthop for packets that match the PBR rule. If all members within a group are unreachable in this manner, then traffic will be routed via default routing behavior, rather than PBR. If the group has a member configured with a NULL destination, when all other members in the group are unreachable, traffic will be dropped (blackhole routed) instead.

Example To configure the point above which packet loss rate is unacceptable to be 5% and the point at or below which packet loss rate is acceptable to be 3.0% for a performance profile named 'profile1', use the following commands:

```
awplus(config)# linkmon profile profile1
awplus(config-linkmon-profile)# pktloss bad-above 5.0
awplus(config-linkmon-profile)# pktloss good-below 3.0
```

To delete the packet loss rate ranges for a performance profile named 'profile1', use the following commands:

```
awplus(config)# linkmon profile profile1
awplus(config-linkmon-profile)# no pktloss bad-above
awplus(config-linkmon-profile)# no pktloss good-below
```

Related commands

- [ip policy-route](#)
- [jitter](#)
- [latency](#)
- [member \(linkmon-group\)](#)
- [linkmon probe](#)
- [linkmon profile](#)
- [preference](#)

Command changes Version 5.4.8-0.2: command added

preference

Overview Use this command to configure the preferred metric of probes that use this Link Health Monitoring performance profile.

Use the **no** variant of this command to remove a preference.

Syntax `preference {latency|jitter|pktloss}`
`no preference`

Parameter	Description
latency	Use latency as the tie-breaker metric.
jitter	Use jitter as the tie-breaker metric.
pktloss	Use packet loss rate as the tie-breaker metric.

Default No preference is applied.

Mode Linkmon Profile Configuration

Usage notes When two or more members within the same group have the same link-health judgment (good, bad), the metric nominated as the preferred one is used as a tie-break to select the best member amongst those that are tied. If the metric values for the preferred metric are identical, or preferred metric is not set in the profile, then the member with the lowest ID is selected as the best one.

Example To choose maximum allowable latency to be the preferred metric for a performance profile named 'profile1', use the following commands:

```
awplus# configure terminal
awplus(config)# linkmon profile profile1
awplus(config-linkmon-profile)# preference latency
```

To delete an existing preference for a performance profile named 'profile1', use the following commands:

```
awplus# configure terminal
awplus(config)# linkmon profile profile1
awplus(config-linkmon-profile)# no preference
```

Related commands

- [ip policy-route](#)
- [jitter](#)
- [latency](#)
- [member \(linkmon-group\)](#)
- [linkmon probe](#)
- [linkmon profile](#)

pktloss

Command changes Version 5.4.8-0.2: command added

sample-size (linkmon-probe)

Overview Use this command to set the sample size used for calculating latency and jitter metrics for a Link Health Monitoring probe.

Use the **no** variant of this command to set the sample size back to the default value.

Syntax `sample-size <1-100>`
`no sample-size`

Parameter	Description
<code><1-100></code>	The number of probe samples to use when calculating the latency and jitter metrics.

Default The default sample size is 5.

Mode Linkmon ICMP Probe Configuration

Example To set the sample size a probe named 'probe1' to 10, use the following commands:

```
awplus(config)# linkmon probe name probe1  
awplus(config-linkmon-icmp-probe)# sample-size 10
```

To set the sample size a probe named 'probe1' back to the default, use the following commands:

```
awplus(config)# linkmon probe name probe1  
awplus(config-linkmon-icmp-probe)# no sample-size
```

Related commands [linkmon probe](#)

Command changes Version 5.4.8-1.1: command added

Version 5.5.1-0.1: command added to all AlliedWare Plus switches

show debugging linkmon

Overview Use this command to display the output of link monitoring debugging settings.

Syntax show debugging linkmon

Mode Privileged Exec

Example To show the current debugging settings for link monitoring, use the following command:

```
awplus# show debugging linkmon
```

Output Figure 33-1: Example output from **show debugging linkmon**

```
awplus#show debugging linkmon
  probes                          TUNNEL10
                                TUNNEL20
  groups                          GROUP1
                                GROUP2
  ip address debugging is        off
  interface debugging is        on
  pbr-group debugging is        on
```

Table 33-1: Parameters in the output from **show debugging linkmon**

Parameter	Description
probes	A list of the Link Health Monitoring probes with debugging enabled.
groups	A list of the Link Health Monitoring groups with debugging enabled.
ip address debugging	Whether IP address debugging is enabled.
interface debugging	Whether interface debugging is enabled.
pbr-group debugging	Whether PBR-group debugging is enabled.

Related commands [debug linkmon](#)

Command changes Version 5.4.8-0.2: command added

show linkmon probe

Overview Use this command to display output for one or all link monitoring probes.

Syntax show linkmon probe [*<probe-name>*]

Parameter	Description
<i><probe-name></i>	The name of the specific probe to display.

Mode User Exec and Privileged Exec

Example To show the output for all link monitoring probes, use the following command:

```
awplus# show linkmon probe
```

To show the output for a link monitoring probe named 'probe1', use the following command:

```
awplus# show linkmon probe probe1
```

Output Figure 33-2: Example output from **show linkmon probe**

```
BRANCH#show linkmon probe
Probe Name      : Head-Office-VPN1
Status         : enabled
Type           : ICMP
IP version      : IPv4
Destination     : 198.51.100.1
Egress Int     : -
Source         : -
DSCP           : -
Packet Size    : -
Interval       : -
Sample Size    : -
Latest Metrics
Latency        : 1001ms
Jitter         : 0ms
Packet Loss    : 0.0%
Probe Details
Probes Sent    : 3154
Last Probe Sent : 23 Mar 2018 03:36:00
Last Probe Received : 23 Mar 2018 03:36:00

Probe Name      : Head-Office-VPN2
Status         : enabled
Type           : ICMP
```

```

IP version      : IPv4
Destination    : 203.0.113.1
Egress Int    : -
Source        : -
DSCP         : -
Packet Size   : -
Interval      : -
Sample Size   : -
Latest Metrics
Latency       : 1000ms
Jitter        : 0ms
Packet Loss   : 0.0%
Probe Details
Probes Sent   : 3154
Last Probe Sent : 23 Mar 2018 03:36:00
Last Probe Received : 23 Mar 2018 03:36:00

```

Table 33-2: Parameters in the output from **show linkmon probe**

Parameter	Description
Name	The name of the probe.
Status	Whether the probe is enabled or disabled. If it is enabled, then the device will attempt to send probes if the link is up. If it is disabled, then no probes will be sent.
Type	The type of probe packet sent.
IP version	The IP version being used, IPv4 or IPv6.
Destination	The destination IP address that the probes are sent to.
Egress Interface	The interface that the probe packets should egress.
Source	The source IP address or interface.
DSCP	The DSCP value to use when sending the packet.
Packet Size	The size of a probe packet.
Interval	The number of milliseconds between sending out each probe.
Sample Size	The number of probe results to use when calculating the latency and jitter metrics.
Latency	The average latency based on the last sample size samples.
Jitter	The average jitter based on the last sample size samples.
Packet Loss	The percentage of packets lost based on the last 100 probes.

Table 33-2: Parameters in the output from **show linkmon probe** (cont.)

Parameter	Description
Probes Sent	The number of probe packets that have been sent.
Last Probe Sent	The time that the last probe packet was sent.
Last Probe Received	The time that the device last successfully received a probe packet.

Related commands [linkmon probe](#)

Command changes Version 5.4.8-0.2: command added
Version 5.5.1-0.1: command added to all AlliedWare Plus switches

show linkmon probe-history

Overview Use this command to show information about Link Health Monitoring probe metric history collection instances.

Syntax show linkmon probe-history [*<1-65535>*|probe *<probe-name>*]

Parameter	Description
<i><1-65535></i>	The ID of the collection instance to show history for.
<i><probe-name></i>	The name of the probe to show history for.

Mode User Exec and Privileged Exec

Example To show all Link Health Monitoring probe history collection instances, use the following command:

```
awplus# show linkmon probe-history
```

To show a Link Health Monitoring probe history collection instance with the ID of '10', use the following command:

```
awplus# show linkmon probe-history 10
```

To show all Link Health Monitoring probe history collection instances that are using a probe named 'probe1', use the following command:

```
awplus# show linkmon probe-history probe probe1
```

Output Figure 33-3: Example output from **show linkmon probe-history**

```
awplus#show linkmon probe-history
```

ID	Interval (s)	Buckets	Latency (ms): Min	Max	Avg
Probe			Jitter (ms): Min	Max	Avg
			Packets: Tx	Rx	Loss (%)
10	1	300/300	94	105	99
PROBE1			2	11	6
			2978	2978	0.00
20	5	300/300	97	102	99
PROBE1			4	9	6
			14892	14892	0.00
30	10	300/300	98	101	100
PROBE1			5	8	6
			29785	29785	0.00

Table 33-3: Parameters in the output from **show linkmon probe-history**

Parameter	Description
ID	The ID of the Link Health Monitoring probe-history.
Probe	The name of the probe that this history is for.
Interval	The amount of time between each history sample (in seconds).
Buckets	The total number of samples that are stored.
Latency min	The minimum latency that is in the history.
Latency max	The maximum latency that is in the history.
Latency avg	The average latency of the samples stored in the history.
Jitter min	The minimum jitter that is in the history.
Jitter max	The maximum jitter that is in the history.
Jitter avg	The average jitter of the samples stored in the history.
Packets Tx	The total number of packets transmitted in this history.
Packets Rx	The total number of packets received in this history.
Packets Loss	The percentage of packets lost in the history.

Related commands [linkmon probe](#)
[linkmon probe-history](#)

Command changes Version 5.4.8-0.2: command added
Version 5.5.1-0.1: command added to all AlliedWare Plus switches

show pbr rules

Overview Use this command to display the configured IPv4 and IPv6 policy routes. It also shows the validity of the policy routes.

Syntax

```
show pbr rules  
show pbr rules <rule-id>  
show pbr rules profile <profile-name>  
show pbr rules group <group-name>
```

Parameter	Description
<rule-id>	The policy route ID. If you specify a policy route ID, the output only lists configuration and status for this specified rule.
<profile-name>	The Link Health Monitoring profile name. If you specify an existing Link Health Monitoring performance profile name, the output only lists profile configuration for this specified profile.
<group-name>	The Link Health Monitoring group name. If you specify an existing Link Health Monitoring group name, the output only lists group configuration for this specified profile.

Mode User Exec and Privileged Exec

Example To show information about the policy routes, use the following command:

```
awplus# show pbr rules
```

To show information about the policy route rule with the rule ID of '1', use the following command:

```
awplus# show pbr rules 1
```

To show information about the Link Health Monitoring profile with the profile name of 'profile1', use the following command:

```
awplus# show pbr rules profile profile1
```

To show information about the Link Health Monitoring group with the profile name of 'group1', use the following command:

```
awplus# show pbr rules group group1
```

Output Figure 33-4: Example output from **show pbr rules**

```
awplus#show pbr rules
Statistics:
-----
Route table usage: 1/500
Total number of configured PBR-rules = 1
-----

PBR-Rule 1
-----
Active:                Yes
Match:                 sip
From:                  LAN
To:                    any
Profile:               PROFILE1
  latency bad above:   300 ms
  latency good below:  - ms
  jitter bad above:    - ms
  jitter good below:   - ms
  pktloss bad above:   - %
  pktloss good below:  - %
Group:                 GROUP1
  Member:              10
    next-hop:          172.16.10.1
    probe:              PROBE10
    latency:            401 ms
    jitter:             0 ms
    pktloss:            0.0 %
  Member:              20
    next-hop:          172.16.20.1
    probe:              PROBE20
    latency:            400 ms
    jitter:             0 ms
    pktloss:            0.0 %
Last Change:
  Current Nexthop:    172.16.10.1
  Previous Nexthop:  -
  Change Time:        22 Nov 2017 13:57:48
  Causes:              Rx probe 'PROBE10', latency (401>300) ms
  Decision:           only available link
Change Count:         1
```

Figure 33-5: Example output from **show pbr rules 1**

```
awplus#show pbr rules 1
PBR-Rule 1
-----
Active:                Yes
Match:                 sip
From:                  LAN
To:                    any
Profile:                PROFILE1
  latency bad above:   300 ms
  latency good below:  - ms
  jitter bad above:    - ms
  jitter good below:   - ms
  pktloss bad above:  - %
  pktloss good below: - %
Group:                 GROUP1
  Member:              10
    next-hop:          172.16.10.1
    probe:              PROBE10
    latency:            401 ms
    jitter:              0 ms
    pktloss:            0.0 %
  Member:              20
    next-hop:          172.16.20.1
    probe:              PROBE20
    latency:            400 ms
    jitter:              0 ms
    pktloss:            0.0 %
Last Change:
  Current Nexthop:    172.16.10.1
  Previous Nexthop:  -
  Change Time:        22 Nov 2017 13:57:48
  Causes:              Rx probe 'PROBE10', latency (401>300) ms
  Decision:            only available link
Change Count:         1
```

Figure 33-6: Example output from **show pbr rules profile profile1**

```
awplus#show pbr rules profile profile1
Profile:                profile1
  latency bad above:   300 ms
  latency good below:  - ms
  jitter bad above:    - ms
  jitter good below:   - ms
  pktloss bad above:  - %
  pktloss good below: - %
```

Figure 33-7: Example output from **show pbr rules group group1**

```
awplus#show pbr rules group group1
Group:          group1
  Member:      10
    next-hop:  172.16.10.1
    probe:     PROBE10
    latency:   401 ms
    jitter:    0 ms
    pktloss:   0.0 %
  Member:      20
    next-hop:  172.16.20.1
    probe:     PROBE20
    latency:   400 ms
    jitter:    0 ms
    pktloss:   0.0 %
```

Table 33-4: Parameters in the output from **show pbr rules**

Parameter	Description
Total number of configured PBR-rules	The number of PBR rules currently configured. This includes both conventional PBR policy-routes and Link Health Monitoring IP policy-routes, regardless of whether the rules are valid or not.
PBR-Rule	The PBR rule ID which the following statistics and configuration are associated with.
Active	Whether the rule is active or not.
Match	The name of an application. Packets will be routed to the specified next hop if they match this application, come from the source entity, and are destined for the destination entity.
From	The name of the source entity. Packets will be routed to the specified next hop if they match the application, come from this source entity, and are destined for the destination entity.
To	The name of the destination entity. Packets will be routed to the specified next hop if they match the application, come from the source entity, and are destined for this destination entity.
Profile	The name of the Link Health Monitoring profile associated with this Link Health Monitoring PBR policy-route.
bad above, good below	The configured threshold for this specific rule. There are fields for latency, jitter, and packet loss. If this field has a value of "-", then the threshold has not been configured.
Group	The name of the Link Health Monitoring group associated with this Link Health Monitoring PBR policy-route.

Table 33-4: Parameters in the output from **show pbr rules** (cont.)

Parameter	Description
Member	The ID of the Link Health Monitoring member associated with this Link Health Monitoring group.
Nexthop	The IPv4 or IPv6 address of the next-hop or the egress interface. There can be up to 8 next-hops per policy route.
probe	The Link Health Monitoring probe associated with the Link Health Monitoring group member.
latency	The latency of the probe associated with the Link Health Monitoring member.
jitter	The jitter of the probe associated with the Link Health Monitoring member.
packet loss	The packet loss of the probe associated with the Link Health Monitoring member.
Current Nexthop	The chosen nexthop for traffic matching the Link Health Monitoring PBR policy-route.
Previous Nexthop	The previously chosen nexthop prior to failover. If a failover hasn't occurred on this setup, there is no previous nexthop. This is indicated by "-".
Change Time	The time at which the current nexthop was chosen. This will change if a failover occurs, or at boot.
Causes	The event that caused the last failover.
Decision	The reason why the current nexthop was chosen.
Change Count	The number of times the chosen nexthop has changed. This counter will increment any time a link failover occurs.

Related commands

- [ip policy-route](#)
- [ipv6 policy-route](#)
- [policy-based-routing](#)
- [show ip pbr route](#)
- [show ipv6 pbr route](#)

Command changes

- Version 5.4.8-0.2: new parameters for profiles and groups added
- Version 5.4.8-1.1: up to 500 route table entries supported

show pbr rules brief

Overview Use this command to show a summary of all PBR rules. It also indicates, by the presence or absence of the nexthop field, which nexthop to route to.

Syntax show pbr rules brief

Mode User Exec and Privileged Exec

Example To show information about the policy routes, use the following command:

```
awplus# show pbr rules brief
```

Output Figure 33-8: Example output from **show pbr rules brief**

```
awplus#show pbr rules brief
Policy based routing is enabled
Route table usage: 2/500
* - No route table available for the rule - see "show ip pbr
route"
Rule Match      From           To             Valid  Nexthop
-----
10  any          entities.any   entities.outside  Yes    10.10.20.2
20  udp          any           any               Yes    2001:100::2
```

Table 33-5: Parameters in the output from **show pbr rules brief**

Parameter	Description
Rule	The policy route ID number. Policy routes are checked in order of ID number, starting with the lowest ID number. The device applies the policy route as soon as it finds a matching route; it does not check the remaining policy routes.
Match	The name of an application. Packets will be routed to the specified next hop if they match this application, come from the source entity, and are destined for the destination entity.
From	The name of the source entity. Packets will be routed to the specified next hop if they match the application, come from this source entity, and are destined for the destination entity.
To	The name of the destination entity. Packets will be routed to the specified next hop if they match the application, come from the source entity, and are destined for this destination entity.

Table 33-5: Parameters in the output from **show pbr rules brief** (cont.)

Parameter	Description
Valid	Whether the application and entities are valid.
Nexthop	The IPv4 or IPv6 address of the next-hop or the egress interface. There can be up to 8 next-hops per policy route.

Related commands [show pbr rules](#)

Command changes Version 5.4.8-0.2: command added
Version 5.4.8-1.1: up to 500 route table entries supported

size (linkmon-probe)

Overview Use this command to set the size of the packets used by a Link Health Monitoring probe.

Use the **no** variant of this command to set the size back to the default.

Syntax `size <64-1500>`
`no size`

Parameter	Description
<code><64-1500></code>	The size of the probe packet in bytes.

Default The default packet size is 100 bytes.

Mode Linkmon ICMP Probe Configuration

Example To set the size of a probe named 'probe1' to 1000, use the following commands:

```
awplus(config)# linkmon probe name probe1  
awplus(config-linkmon-icmp-probe)# size 1000
```

To set the size of a probe named 'probe1' back to the default, use the following commands:

```
awplus(config)# linkmon probe name probe1  
awplus(config-linkmon-icmp-probe)# no size
```

Related commands [linkmon probe](#)

Command changes Version 5.4.8-1.1: command added

Version 5.5.1-0.1: command added to all AlliedWare Plus switches

source (linkmon-probe)

Overview Use this command to set the source IP address or interface for a Link Health Monitoring probe.

Use the **no** variant of this command to return it to the default.

Syntax `source {<interface>|<ip-address>}`
`no source`

Parameter	Description
<code><interface></code>	The name of the interface that probes are sourcing from. The specified interface needs to be locally configured with at least one valid IPv4 address, and the interface is in up and running state.
<code><ip-address></code>	The source IPv4 address for this probe. The specified IP address needs to be locally configured on an interface that is in an up-and-running state.

Default No source IP address is defined by default. The source IP address will be selected using standard routing behavior to reach the probe's destination.

Mode Linkmon ICMP Probe Configuration

Example To set the source interface as 'lo' for a probe named 'probe1', use the following commands:

```
awplus(config)# linkmon probe name probe1  
awplus(config-linkmon-icmp-probe)# source lo
```

To set the source interface back to default for a probe named 'probe1', use the following commands:

```
awplus(config)# linkmon probe name probe1  
awplus(config-linkmon-icmp-probe)# no source
```

Related commands [linkmon probe](#)

Command changes Version 5.4.8-1.1: command added
Version 5.5.1-0.1: command added to all AlliedWare Plus switches

url (linkmon-probe)

Overview Use this command to set the destination URL of a Link Health Monitoring probe. This is a required configuration option for http-get probes.

Use the **no** variant of this command to remove the URL.

Syntax url <url>
no url

Parameter	Description
<url>	The destination the probe is being sent to. The URL must use ASCII characters and conform to the URL syntax in RFC 3986, with http or https protocol at the start and an optional port number on the end, such as :80, :443 or :8080.

Mode Linkmon HTTP Probe Configuration

Example To set the destination URL of a Link Health Monitoring probe named "test-probe", use the following commands:

```
awplus# configure terminal
awplus(config)# linkmon probe name test-probe type http
awplus(config-linkmon-http-probe)# url
http://www.alliedtelesis.co.nz/
```

Some other examples of supported URL formats:

```
awplus(config-linkmon-http-probe)# url
https://www.facebook.com/
awplus(config-linkmon-http-probe)# url
http://intranet.atlnz.lc:8080
```

To remove the URL, use the following commands:

```
awplus# configure terminal
awplus(config)# linkmon probe name test-probe type http
awplus(config-linkmon-http-probe)# no url
```

Related commands [linkmon probe](#)

Command changes Version 5.4.8-1.1: command added
Version 5.5.1-0.1: command added to all AlliedWare Plus switches

Part 4: Multicast Applications

34

IGMP and IGMP Snooping Commands

Introduction

Overview Devices running AlliedWare Plus use IGMP (Internet Group Management Protocol) and MLD (Multicast Listener Discovery) to track which multicast groups their clients belong to. This enables them to send the correct multimedia streams to the correct destinations. IGMP is used for IPv4 multicasting, and MLD is used for IPv6 multicasting.

This chapter describes the commands to configure IGMP Querier behaviour and selection, IGMP Snooping and IGMP Proxy.

- Command List**
- [“clear ip igmp”](#) on page 1785
 - [“clear ip igmp group”](#) on page 1786
 - [“clear ip igmp interface”](#) on page 1787
 - [“debug igmp”](#) on page 1788
 - [“ip igmp”](#) on page 1789
 - [“ip igmp flood specific-query”](#) on page 1790
 - [“ip igmp last-member-query-count”](#) on page 1791
 - [“ip igmp last-member-query-interval”](#) on page 1792
 - [“ip igmp maximum-groups”](#) on page 1793
 - [“ip igmp mroute-proxy”](#) on page 1795
 - [“ip igmp proxy-service”](#) on page 1796
 - [“ip igmp querier-timeout”](#) on page 1798
 - [“ip igmp query-holdtime”](#) on page 1799
 - [“ip igmp query-interval”](#) on page 1801
 - [“ip igmp query-max-response-time”](#) on page 1803
 - [“ip igmp ra-option”](#) on page 1805

- [“ip igmp robustness-variable”](#) on page 1806
- [“ip igmp snooping”](#) on page 1807
- [“ip igmp snooping fast-leave”](#) on page 1808
- [“ip igmp snooping mrouter”](#) on page 1809
- [“ip igmp snooping querier”](#) on page 1810
- [“ip igmp snooping report-suppression”](#) on page 1811
- [“ip igmp snooping routermode”](#) on page 1812
- [“ip igmp snooping source-timeout”](#) on page 1814
- [“ip igmp snooping tcn query solicit”](#) on page 1815
- [“ip igmp source-address-check”](#) on page 1817
- [“ip igmp startup-query-count”](#) on page 1818
- [“ip igmp startup-query-interval”](#) on page 1819
- [“ip igmp trusted”](#) on page 1820
- [“ip igmp version”](#) on page 1821
- [“show debugging igmp”](#) on page 1822
- [“show ip igmp groups”](#) on page 1823
- [“show ip igmp interface”](#) on page 1825
- [“show ip igmp proxy”](#) on page 1827
- [“show ip igmp proxy groups”](#) on page 1828
- [“show ip igmp snooping mrouter”](#) on page 1830
- [“show ip igmp snooping routermode”](#) on page 1831
- [“show ip igmp snooping source-timeout”](#) on page 1832
- [“show ip igmp snooping statistics”](#) on page 1833
- [“undebg igmp”](#) on page 1835

clear ip igmp

Overview Use this command to clear all IGMP group membership records on all interfaces where it is configured .

Syntax `clear ip igmp`

Mode Privileged Exec

Example To delete all IGMP records, use the command

```
awplus# clear ip igmp
```

Related commands

- [clear ip igmp group](#)
- [clear ip igmp interface](#)
- [show ip igmp interface](#)
- [show running-config](#)

Command changes

- Version 5.4.7-1.1: VRF-lite support added SBx8100.
- Version 5.4.8-1.1: VRF-lite support added x930, SBx908 GEN2.

clear ip igmp group

Overview Use this command to clear IGMP group membership records for a specific group on either all interfaces, a single interface, or for a range of interfaces.

Syntax `clear ip igmp group *`
`clear ip igmp group <ip-address> <interface>`

Parameter	Description
*	Clears all groups on all interfaces. This has the same effect as the clear ip igmp command.
<ip-address>	Specifies the group whose membership records will be cleared from all interfaces, entered in the form A.B.C.D.
<interface>	Specifies the name of the interface; all groups learned on this interface are deleted.

Mode Privileged Exec

Usage notes This command applies to groups learned by IGMP or IGMP Snooping. In addition to the group, an interface can be specified. Specifying this will mean that only entries with the group learned on the interface will be deleted.

Examples To delete all group records, use the command:

```
awplus# clear ip igmp group *
```

To delete records for 224.1.1.1 on vlan1, use the command:

```
awplus# clear ip igmp group 224.1.1.1 vlan1
```

Related commands [clear ip igmp](#)
[clear ip igmp interface](#)
[show ip igmp interface](#)
[show running-config](#)

Command changes Version 5.4.7-1.1: VRF-lite support added SBx8100.
Version 5.4.8-1.1: VRF-lite support added x930, SBx908 GEN2.

clear ip igmp interface

Overview Use this command to clear IGMP group membership records on a particular interface.

Syntax `clear ip igmp interface <interface>`

Parameter	Description
<interface>	Specifies the name of the interface. All groups learned on this interface are deleted.

Mode Privileged Exec

Usage notes This command applies to interfaces configured for IGMP or IGMP Snooping.

Example To delete records for vlan1, use the command:

```
awplus# clear ip igmp interface vlan1
```

Related commands

- [clear ip igmp](#)
- [clear ip igmp group](#)
- [show ip igmp interface](#)
- [show running-config](#)

Command changes

- Version 5.4.7-1.1: VRF-lite support added SBx8100.
- Version 5.4.8-1.1: VRF-lite support added x930, SBx908 GEN2.

debug igmp

Overview Use this command to enable debugging of either all IGMP or a specific component of IGMP.

Use the **no** variant of this command to disable all IGMP debugging, or debugging of a specific component of IGMP.

Syntax `debug igmp {all|decode|encode|events|fsm|tib}`
`no debug igmp {all|decode|encode|events|fsm|tib}`

Parameter	Description
all	Enable or disable all debug options for IGMP
decode	Debug of IGMP packets that have been received
encode	Debug of IGMP packets that have been sent
events	Debug IGMP events
fsm	Debug IGMP Finite State Machine (FSM)
tib	Debug IGMP Tree Information Base (TIB)

Modes Privileged Exec and Global Configuration

Example `awplus# configure terminal`
`awplus(config)# debug igmp all`

Related commands [show debugging igmp](#)
[undebug igmp](#)

Command changes Version 5.4.7-1.1: VRF-lite support added SBx8100.
Version 5.4.8-1.1: VRF-lite support added x930, SBx908 GEN2.

ip igmp

Overview Use this command to enable IGMP on an interface. The command configures the device as an IGMP querier.

Use the **no** variant of this command to return all IGMP related configuration to the default on this interface.

Syntax ip igmp
no ip igmp

Default Disabled

Mode Interface Configuration for a VLAN or Eth interface.

Usage notes An IP address must be assigned to the interface first, before this command will work.

Example To specify an interface as an IGMP querier, use the commands:

```
awplus# configure terminal
awplus(config)# interface vlan2
awplus(config-if)# ip igmp
```

Related commands [show ip igmp interface](#)
[show running-config](#)

ip igmp flood specific-query

Overview Use this command if you want IGMP to flood specific queries to all VLAN member ports, instead of only sending the queries to multicast group member ports.

Use the **no** variant of this command if you want IGMP to only send the queries to multicast group member ports.

Syntax `ip igmp flood specific-query`
`no ip igmp flood specific-query`

Default By default, specific queries are flooded to all VLAN member ports.

Mode Global Configuration

Usage In an L2 switched network running IGMP, it is considered more robust to flood all specific queries. In most cases, the benefit of flooding specific queries to all VLAN member ports outweighs the disadvantages.

However, sometimes this is not the case. For example, if hosts with very low CPU capability receive specific queries for multicast groups they are not members of, their performance may degrade unacceptably. In this situation, it is desirable for IGMP to send specific queries to known member ports only. This minimizes the performance degradation of such hosts. In those circumstances, use this command to turn off flooding of specific queries.

Example To cause IGMP to flood specific queries only to multicast group member ports, use the commands:

```
awplus# configure terminal
awplus(config)# no ip igmp flood specific-query
```

Related commands [show ip igmp interface](#)

Command changes Version 5.4.7-1.1: VRF-lite support added SBx8100.

Version 5.4.8-1.1: VRF-lite support added x930, SBx908 GEN2.

ip igmp last-member-query-count

Overview Use this command to set the last-member query-count value for an interface.
Use the **no** variant of this command to return to the default on an interface.

Syntax `ip igmp last-member-query-count <2-7>`
`no ip igmp last-member-query-count`

Parameter	Description
<2-7>	Last member query count value.

Default The default last member query count value is 2.

Mode Interface Configuration for a VLAN or Eth interface.

Usage notes This command applies to Eth interfaces configured for IGMP and VLAN interfaces configured for IGMP or IGMP Snooping.

Example To set the last-member query-count to 3 on vlan2, use the commands:

```
awplus# configure terminal
awplus(config)# interface vlan2
awplus(config-if)# ip igmp last-member-query-count 3
```

Related commands [ip igmp last-member-query-interval](#)
[ip igmp startup-query-count](#)
[show ip igmp interface](#)
[show running-config](#)

ip igmp last-member-query-interval

Overview Use this command to configure the frequency at which the router sends IGMP group specific host query messages.

Use the **no** variant of this command to set this frequency to the default.

Syntax `ip igmp last-member-query-interval <interval>`
`no ip igmp last-member-query-interval`

Parameter	Description
<code><interval></code>	The frequency in milliseconds at which IGMP group-specific host query messages are sent, in the range 1000-25500.

Default 1000 milliseconds

Mode Interface Configuration for a VLAN or Eth interface.

Usage notes This command applies to Eth interfaces configured for IGMP and VLAN interfaces configured for IGMP or IGMP Snooping.

Example To change the IGMP group-specific host query message interval to 2 seconds (2000 milliseconds) on vlan2, use the commands:

```
awplus# configure terminal
awplus(config)# interface vlan2
awplus(config-if)# ip igmp last-member-query-interval 2000
```

Related commands [ip igmp last-member-query-count](#)
[show ip igmp interface](#)
[show running-config](#)

ip igmp maximum-groups

Overview Use this command to set a limit, per switch port, on the number of IGMP groups clients can join. This stops a single client from using all the switch's available group-entry resources, and ensures that clients on all ports have a chance to join IGMP groups.

Use the **no** variant of this command to remove the limit.

Syntax `ip igmp maximum-groups <0-65535>`
`no ip igmp maximum-groups`

Parameter	Description
<code><0-65535></code>	The maximum number of IGMP groups clients can join on this switch port. 0 means no limit.

Default The default is 0, which means no limit

Mode Interface mode for a switch port

Usage notes We recommend using this command with IGMP snooping fast leave on the relevant VLANs. To enable fast leave, use the command:

```
awplus(config-if)# ip igmp snooping fast-leave
```

The device keeps count of the number of groups learned by each port. This counter is incremented when group joins are received via IGMP reports. It is decremented when:

- Group memberships time out
- Group leaves are received via leave messages or reports

Also, the port's group counter is cleared when:

- The port goes down
- You run the command **clear ip igmp group ***
- The port is removed from a VLAN

You can see the current value of the group counter by using either of the commands:

```
awplus# show ip igmp snooping statistics interface <port-list>
```

```
awplus# show ip igmp interface <port>
```

Example To limit clients to 10 groups on port 1.0.1, which is in vlan1, use the commands:

```
awplus# configure terminal
awplus(config)# interface port1.0.1
awplus(config-if)# ip igmp maximum-groups 10
awplus(config-if)# exit
awplus(config)# interface vlan1
awplus(config-if)# ip igmp snooping fast-leave
```

Related commands

- [clear ip igmp group](#)
- [ip igmp snooping fast-leave](#)
- [show ip igmp interface](#)
- [show ip igmp snooping statistics](#)

ip igmp mroute-proxy

Overview Use this command to enable IGMP mroute proxy on this downstream interface and associate it with the upstream proxy service interface.

Use the **no** variant of this command to remove the association with the proxy-service interface.

Syntax `ip igmp mroute-proxy <interface>`
`no ip igmp mroute-proxy`

Parameter	Description
<interface>	The name of the interface.

Mode Interface Configuration for a VLAN or Eth interface.

Usage notes This command applies to Eth interfaces and VLAN interfaces configured for IGMP Proxy.

You must also enable the IGMP proxy service on the upstream interface, using the [ip igmp proxy-service](#) command. You can associate one or more downstream mroute proxy interfaces on the device with a single upstream proxy service interface. This downstream mroute proxy interface listens for IGMP reports, and forwards them to the upstream IGMP proxy service interface.

IGMP Proxy does not work with other multicast routing protocols, such as PIM-SM or PIM-DM.

Example To configure vlan3 as the upstream proxy-service interface for the downstream vlan2 interface, use the commands:

```
awplus# configure terminal
awplus(config)# ip multicast-routing
awplus(config)# interface vlan3
awplus(config-if)# ip igmp proxy-service
awplus(config-if)# ip igmp
awplus(config)# interface vlan2
awplus(config-if)# ip igmp mroute-proxy vlan3
awplus(config-if)# ip igmp
```

Related commands [ip igmp](#)
[ip igmp proxy-service](#)
[ip multicast-routing](#)

ip igmp proxy-service

Overview Use this command to enable an interface to be the upstream IGMP proxy-service interface for the device. All associated downstream IGMP mroute proxy interfaces on this device will have their memberships consolidated on this proxy service interface, according to IGMP host-side functionality.

Use the **no** variant of this command to remove the designation of the interface as an upstream proxy-service interface.

Syntax `ip igmp proxy-service`
`no ip igmp proxy-service`

Mode Interface Configuration for a VLAN or Eth interface.

Usage notes This command applies to Eth interfaces and VLAN interfaces configured for IGMP Proxy.

This command is used with the `ip igmp mroute-proxy` command to enable forwarding of IGMP reports to a proxy service interface for all forwarding entries for this interface. You must also enable the downstream IGMP mroute proxy interfaces on this device using the command `ip igmp mroute-proxy`.

IGMP Proxy does not work with other multicast routing protocols, such as PIM-SM or PIM-DM.

From version 5.4.7-1.1 onwards, IGMP mroute proxy interfaces do not have to be configured with an IP address before they can operate. Instead, it is possible to have an addressless interface operate as an IGMP mroute proxy interface.

This feature is useful when IGMP Proxy needs to run on many downstream interfaces. For example, you may want to use it if your device has one subscriber (multicast receiver) per VLAN, and many receivers (many VLANs) connected to the device. In such a situation, assigning IP addresses to each VLAN may not be practicable.

Note that for such interface to be able to send queries to hosts directly attached to the interface, it is necessary to enable IGMP snooping querier on the interface, using the command `ip igmp snooping querier`.

Example To configure vlan3 as the upstream proxy-service interface for the downstream vlan2 interface, use the commands:

```
awplus# configure terminal
awplus(config)# ip multicast-routing
awplus(config)# interface vlan3
awplus(config-if)# ip igmp proxy-service
awplus(config-if)# ip igmp
awplus(config)# interface vlan2
awplus(config-if)# ip igmp mroute-proxy vlan3
awplus(config-if)# ip igmp
```

Related commands

- ip igmp
- ip igmp mroute-proxy
- ip igmp snooping querier
- ip multicast-routing

Command changes

- Version 5.4.7-1.1: Addressless interface support added.
- Version 5.4.7-1.1: VRF-lite support added to SBx8100.
- Version 5.4.8-1.1: VRF-lite support added to x930, SBx908 GEN2.

ip igmp querier-timeout

Overview Use this command to configure the timeout period before the device takes over as the querier for the interface after the previous querier has stopped querying.

Use the **no** variant of this command to restore the default.

Syntax `ip igmp querier-timeout <timeout>`
`no ip igmp querier-timeout`

Parameter	Description
<code><timeout></code>	IGMP querier timeout interval value in seconds, in the range 1-65535.

Default The default timeout interval is 255 seconds.

Mode Interface Configuration for a VLAN or Eth interface.

Usage notes This command applies to Eth and VLAN interfaces configured for IGMP.

The timeout value should not be less than the current active querier's general query interval.

Example To configure the device to wait 130 seconds from the time it received the last query before it takes over as the querier for vlan2, use the commands:

```
awplus# configure terminal
awplus(config)# interface vlan2
awplus(config-if)# ip igmp querier-timeout 130
```

Related commands `ip igmp query-interval`
`show ip igmp interface`
`show running-config`

ip igmp query-holdtime

Overview This command sets the time that an IGMP Querier waits after receiving a query solicitation before it sends an IGMP Query. IGMP General Query messages will not be sent during the hold time interval.

Use the **no** variant of this command to return to the default query hold time period.

Syntax `ip igmp query-holdtime <interval>`
`no ip igmp query-holdtime`

Parameter	Description
<interval>	Query interval value in milliseconds, in the range <100-5000>.

Default By default the delay before sending IGMP General Query messages is 500 milliseconds.

Mode Interface Configuration for a VLAN or Eth interface.

Usage notes Use this command to configure a value for the IGMP query hold time in the current network. IGMP Queries can be generated after receiving Query Solicitation (QS) packets and there is a possibility of a DoS (Denial of Service) attack if a stream of Query Solicitation (QS) packets are sent to the IGMP Querier, eliciting a rapid stream of IGMP Queries. This command applies to interfaces on which the device is acting as an IGMP Querier.

Use the `ip igmp query-interval` command when a delay for IGMP general query messages is required and IGMP general query messages are required. The **ip igmp query-holdtime** command stops IGMP query messages during the configured holdtime interval, so the rate of IGMP Queries that can be sent out of an interface can be restricted.

See the [IGMP Feature Overview and Configuration Guide](#) for introductory information about the Query Solicitation feature.

Examples To set the IGMP query holdtime to 900 ms for vlan20, use the following commands:

```
awplus# configure terminal
awplus(config)# interface vlan20
awplus(config-if)# ip igmp query-holdtime 900
```

To reset the IGMP query holdtime to the default (500 ms) for vlan10, use the following commands:

```
awplus# configure terminal
awplus(config)# interface vlan10
awplus(config-if)# no ip igmp query-holdtime
```

Related commands

- ip igmp query-interval
- ip igmp snooping tcn query solicit
- show ip igmp interface
- show running-config

ip igmp query-interval

Overview Use this command to configure the period for sending IGMP General Query messages.

The IGMP query interval specifies the time between IGMP General Query messages being sent.

Use the **no** variant of this command to return to the default query interval period.

NOTE: The IGMP query interval must be greater than IGMP query maximum response time.

Syntax `ip igmp query-interval <interval>`
`no ip igmp query-interval`

Parameter	Description
<interval>	Query interval value in seconds, in the range <2-18000>.

Default The default IGMP query interval is 125 seconds.

Mode Interface Configuration for a VLAN or Eth interface.

Usage notes This command applies to interfaces configured for IGMP. Note that the IGMP query interval is automatically set to a greater value than the IGMP query max response time.

For example, if you set the IGMP query max response time to 2 seconds using the [ip igmp query-max-response-time](#) command, and the IGMP query interval is currently less than 3 seconds, then the IGMP query interval period will be automatically reconfigured to be 3 seconds, so it is greater than the IGMP query maximum response time.

Use the **ip igmp query-interval** command when a non-default interval for IGMP General Query messages is required.

The [ip igmp query-holdtime](#) command can occasionally delay the sending of IGMP Queries.

Examples To set the period between IGMP host-query messages to 3 minutes (180 seconds) for vlan20, use the following commands:

```
awplus# configure terminal
awplus(config)# interface vlan20
awplus(config-if)# ip igmp query-interval 180
```

To reset the period between sending IGMP host-query messages to the default (125 seconds) for vlan10, use the following commands:

```
awplus# configure terminal
awplus(config)# interface vlan10
awplus(config-if)# no ip igmp query-interval
```

**Related
commands**

```
ip igmp query-holdtime
ip igmp query-max-response-time
ip igmp startup-query-interval
show ip igmp interface
show running-config
```

ip igmp query-max-response-time

Overview Use this command to configure the maximum response time advertised in IGMP Queries.

Use the **no** variant of this command to restore the default.

NOTE: *The IGMP query maximum response time must be less than the IGMP query interval.*

Syntax `ip igmp query-max-response-time <response-time>`
`no ip igmp query-max-response-time`

Parameter	Description
<code><response-time></code>	Response time value in seconds, in the range 1-3180.

Default The default IGMP query maximum response time is 10 seconds.

Mode Interface Configuration for a VLAN or Eth interface.

Usage notes This command applies to interfaces configured for IGMP.

Note that the IGMP query interval is automatically set to a greater value than the IGMP query maximum response time.

For example, if you set the IGMP query interval to 3 seconds using the `ip igmp query-interval` command, and the current IGMP query interval is less than 3 seconds, then the IGMP query maximum response time will be automatically reconfigured to be 2 seconds, so it is less than the IGMP query interval time.

To get the network to converge faster, use the **ip igmp query-max-response-time** command and set a low response time value, such as one or two seconds, so that the clients will respond immediately with a report as a response to the IGMP Queries.

Examples To set a maximum response time of 8 seconds for vlan20, use the following commands:

```
awplus# configure terminal
awplus(config)# interface vlan20
awplus(config-if)# ip igmp query-max-response-time 8
```

To reset the default maximum response time to the default (10 seconds) for vlan10, use the following commands:

```
awplus# configure terminal
awplus(config)# interface vlan10
awplus(config-if)# no ip igmp query-max-response-time
```

Related commands ip igmp query-interval
show ip igmp interface
show running-config

ip igmp ra-option

Overview Use this command to enable strict Router Alert (RA) option validation. With strict RA option enabled, IGMP packets without RA options are ignored.

Use the **no** variant of this command to disable strict RA option validation.

Syntax `ip igmp ra-option`
`no ip igmp ra-option`

Default The default state of RA validation is unset.

Mode Interface Configuration for a VLAN or Eth interface.

Usage notes This command applies to interfaces configured for IGMP and IGMP Snooping.

Examples To enable strict Router Alert (RA) option validation on vlan20, use the following commands:

```
awplus# configure terminal
awplus(config)# interface vlan20
awplus(config-if)# ip igmp ra-option
```

ip igmp robustness-variable

Overview Use this command to change the robustness variable value on an interface.
Use the **no** variant of this command to return to the default on an interface.

Syntax `ip igmp robustness-variable <1-7>`
`no ip igmp robustness-variable`

Parameter	Description
<1-7>	The robustness variable value.

Default The default robustness variable value is 2.

Mode Interface Configuration for a VLAN or Eth interface.

Usage notes This command applies to interfaces configured for IGMP and IGMP Snooping.

Examples To set the robustness variable to 3 on vlan20, use the following commands:

```
awplus# configure terminal
awplus(config)# interface vlan20
awplus(config-if)# ip igmp robustness-variable 3
```

Related commands [show ip igmp interface](#)
[show running-config](#)

ip igmp snooping

Overview Use this command to enable IGMP Snooping. When this command is used in the Global Configuration mode, IGMP Snooping is enabled at the device level. When this command is used in Interface Configuration mode, IGMP Snooping is enabled for the specified VLANs.

Use the **no** variant of this command to either globally disable IGMP Snooping, or disable IGMP Snooping on a specified interface.

NOTE: *IGMP snooping cannot be disabled on an interface if IGMP snooping has already been disabled globally. IGMP snooping can be disabled on both an interface and globally if disabled on the interface first and then disabled globally.*

Syntax ip igmp snooping
no ip igmp snooping

Default By default, IGMP Snooping is enabled both globally and on all VLANs.

Mode Global Configuration and Interface Configuration for a VLAN interface.

Usage notes For IGMP snooping to operate on particular VLAN interfaces, it must be enabled both globally by using this command in Global Configuration mode, and on individual VLAN interfaces by using this command in Interface Configuration mode (both are enabled by default.)

Both IGMP snooping and MLD snooping must be enabled globally on the device for IGMP snooping to operate. MLD snooping is also enabled by default. To enable it if it has been disabled, use the [ipv6 mld snooping](#) command in Global Configuration mode.

Examples To enable IGMP Snooping on vlan2, use the commands:

```
awplus# configure terminal
awplus(config)# ip igmp snooping
awplus(config)# interface vlan2
awplus(config-if)# ip igmp snooping
```

Related commands [ipv6 mld snooping](#)
[show ip igmp interface](#)
[show running-config](#)

ip igmp snooping fast-leave

Overview Use this command to enable IGMP Snooping fast-leave processing. Fast-leave processing is analogous to immediate-leave processing. The IGMP group-membership entry is removed as soon as an IGMP leave group message is received, without sending out a group-specific query.

Use the **no** variant of this command to disable fast-leave processing.

Syntax `ip igmp snooping fast-leave`
`no ip igmp snooping fast-leave`

Default IGMP Snooping fast-leave processing is disabled.

Mode Interface Configuration for a VLAN interface.

Usage notes This IGMP Snooping command can only be configured on VLAN interfaces.

Example To enable fast-leave processing on vlan2, use the commands:

```
awplus# configure terminal
awplus(config)# interface vlan2
awplus(config-if)# ip igmp snooping fast-leave
```

Related commands [show ip igmp interface](#)
[show running-config](#)

ip igmp snooping mrouter

Overview Use this command to statically configure the specified port as a multicast router port for IGMP Snooping for an interface. This command applies to interfaces configured for IGMP Snooping.

Use the **no** variant of this command to remove the static configuration of the port as a multicast router port.

Syntax `ip igmp snooping mrouter interface <port>`
`no ip igmp snooping mrouter interface <port>`

Parameter	Description
<code><port></code>	The port may be a device port (e.g. port1.0.2), a static channel group (e.g. sa3), or a dynamic (LACP) channel group (e.g. po4).

Mode Interface Configuration for a VLAN interface.

Example To configure port1.0.2 statically as a multicast router interface for vlan2, use the commands:

```
awplus# configure terminal
awplus(config)# interface vlan2
awplus(config-if)# ip igmp snooping mrouter interface port1.0.2
```

Related commands [show ip igmp snooping mrouter](#)

ip igmp snooping querier

Overview Use this command to enable IGMP querier operation when no multicast routing protocol is configured. When enabled, the IGMP Snooping querier sends out periodic IGMP queries for all interfaces. This command applies to interfaces configured for IGMP Snooping.

Use the **no** variant of this command to disable IGMP querier configuration.

Syntax `ip igmp snooping querier`
`no ip igmp snooping querier`

Mode Interface Configuration for a VLAN interface.

Usage notes The IGMP Snooping querier uses the 0.0.0.0 Source IP address because it only masquerades as a proxy IGMP querier for faster network convergence.

It does not start, or automatically cease, the IGMP Querier operation if it detects query message(s) from a multicast router.

If an IP address is assigned to a VLAN, which has IGMP querier enabled on it, then the IGMP Snooping querier uses the VLAN's IP address as the Source IP Address in IGMP queries.

The IGMP Snooping Querier will not stop sending IGMP Queries if there is another IGMP Snooping Querier in the network with a lower Source IP Address.

NOTE: Do not enable the IGMP Snooping Querier feature on a Layer 2 device when there is an operational IGMP Querier in the network.

Example To configure vlan2 as a Snooping querier, use the commands:

```
awplus# configure terminal
awplus(config)# interface vlan2
awplus(config-if)# ip igmp snooping querier
```

Related commands [show ip igmp interface](#)
[show running-config](#)

ip igmp snooping report-suppression

Overview Use this command to enable report suppression for IGMP versions 1 and 2. This command applies to interfaces configured for IGMP Snooping.

Report suppression stops reports being sent to an upstream multicast router port when there are already downstream ports for this group on this interface.

Use the **no** variant of this command to disable report suppression.

Syntax `ip igmp snooping report-suppression`
`no ip igmp snooping report-suppression`

Default Report suppression does not apply to IGMPv3, and is turned on by default for IGMPv1 and IGMPv2 reports.

Mode Interface Configuration for a VLAN interface.

Example To enable report suppression for IGMPv2 reports for vlan2, use the commands:

```
awplus# configure terminal
awplus(config)# interface vlan2
awplus(config-if)# ip igmp version 2
awplus(config-if)# ip igmp snooping report-suppression
```

Related commands [show ip igmp interface](#)
[show running-config](#)

ip igmp snooping routermode

Overview Use this command to set the destination IP addresses as router multicast addresses.

Use the **no** variant of this command to set it to the default. You can also remove a specified IP address from a custom list of multicast addresses.

Syntax ip igmp snooping routermode
{all|default|ip|multicastrouter|address <ip-address>}
no ip igmp snooping routermode [address <ip-address>]

Parameter	Description
all	All reserved multicast addresses (224.0.0.x). Packets from all possible addresses in range 224.0.0.x are treated as coming from routers.
default	Default set of reserved multicast addresses. Packets from 224.0.0.1, 224.0.0.2, 224.0.0.4, 224.0.0.5, 224.0.0.6, 224.0.0.9, 224.0.0.13, 224.0.0.15 and 224.0.0.24 are treated as coming from routers.
ip	Custom reserved multicast addresses. Packets from custom IP address in the 224.0.0.x range are treated as coming from routers.
multicastrouter	Packets from DVMRP (224.0.0.4) and PIM (224.0.0.13) multicast addresses are treated as coming from routers.
address <ip-address>	Packets from the specified multicast address are treated as coming from routers. The address must be in the 224.0.0.x range.

Default The default routermode is **default** (not **all**) and shows the following reserved multicast addresses:

```
Router mode.....Def
Reserved multicast address
224.0.0.1
224.0.0.2
224.0.0.4
224.0.0.5
224.0.0.6
224.0.0.9
224.0.0.13
224.0.0.15
224.0.0.24
```

Mode Global Configuration

Examples To set **ip igmp snooping routermode** for all default reserved addresses enter:

```
awplus(config)# ip igmp snooping routermode default
```

To remove the multicast address 224.0.0.5 from the custom list of multicast addresses enter:

```
awplus(config)# no ip igmp snooping routermode address  
224.0.0.5
```

Related commands [ip igmp trusted](#)
[show ip igmp snooping routermode](#)

Command changes Version 5.4.7-1.1: VRF-lite support added SBx8100.
Version 5.4.8-1.1: VRF-lite support added x930, SBx908 GEN2.

ip igmp snooping source-timeout

Overview Use this command to set the global IGMP Snooping source time-out value (in seconds) on the switch.

Use the **no** variant of this command to set the source time-out value to be the same as the group membership timeout.

Syntax `ip igmp snooping source-timeout <timeout>`
`no ip igmp snooping source-timeout <timeout>`

Parameter	Description
<code><timeout></code>	Time-out value in seconds <code><0-86400></code>

Default Global IGMP Snooping source-timeout is disabled by default, and unregistered multicast will be timed-out like normal entries.

Interface IGMP Snooping source timeout is disabled by default, and unregistered multicast will be timed-out like normal entries.

Mode Interface/Global Configuration

Usage notes The timeout determines how long unregistered multicast entries will be kept for. If the value '0' is specified, then effectively all unregistered multicast entries will never be timed out, and can only be cleared by using the command **clear ip igmp group**. The interface settings will always take precedence over the global setting.

Example To configure IGMP Snooping source timeout on 'vlan1', use the commands:

```
awplus# configure terminal
awplus(config)# interface vlan1
awplus(config-if)# ip igmp snooping source-timeout 200
```

Related commands [show ip igmp snooping source-timeout](#)

ip igmp snooping tcn query solicit

Overview Use this command to enable IGMP (Internet Group Management Protocol) Snooping TCN (Topology Change Notification) Query Solicitation feature. When this command is used in the Global Configuration mode, Query Solicitation is enabled.

Use the **no** variant of this command to disable IGMP Snooping TCN Query Solicitation. When the **no** variant of this command is used in Interface Configuration mode, this overrides the Global Configuration mode setting and Query Solicitation is disabled.

Syntax `ip igmp snooping tcn query solicit`
`no ip igmp snooping tcn query solicit`

Default IGMP Snooping TCN Query Solicitation is disabled by default on the device, unless the device is the Master Node in an EPSR ring, or is the Root Bridge in a Spanning Tree.

When the device is the Master Node in an EPSR ring, or the device is the Root Bridge in a Spanning Tree, then IGMP Snooping TCN Query Solicitation is enabled by default and cannot be disabled using the Global Configuration mode command. However, Query Solicitation can be disabled for specified interfaces using the **no** variant of this command from the Interface Configuration mode.

Mode Global Configuration, and Interface Configuration for a VLAN interface.

Usage notes Once enabled, if the device is not an IGMP Querier, on detecting a topology change, the device generates IGMP Query Solicit messages that are sent to all the ports of the vlan configured for IGMP Snooping on the device.

On a device that is not the Master Node in an EPSR ring or the Root Bridge in a Spanning Tree, Query Solicitation can be disabled using the **no** variant of this command after being enabled.

If the device that detects a topology change is an IGMP Querier then the device will generate an IGMP Query message.

Note that the **no** variant of this command when issued in Global Configuration mode has no effect on a device that is the Master Node in an EPSR ring or on a device that is a Root Bridge in a Spanning Tree. Query Solicitation is not disabled for the device these instances. However, Query Solicitation can be disabled on a per-vlan basis from the Interface Configuration mode.

See the following state table that shows when Query Solicit messages are sent in these instances:

Command issued from Global Configuration	Command issued from Interface Configuration	Device is STP Root Bridge or the EPSR Master Node	IGMP Query Solicit message sent on VLAN
No	Yes	Yes	Yes
Yes	No	Yes	No
Yes	Yes	Yes	Yes

See the [IGMP Feature Overview and Configuration Guide](#) for introductory information about the Query Solicitation feature.

Examples To enable Query Solicitation on a device, use the commands:

```
awplus# configure terminal  
awplus(config)# ip igmp snooping tcn query solicit
```

To disable Query Solicitation on a device, use the commands:

```
awplus# configure terminal  
awplus(config)# no ip igmp snooping tcn query solicit
```

To enable Query Solicitation for vlan2, use the commands:

```
awplus# configure terminal  
awplus(config)# interface vlan2  
awplus(config-if)# ip igmp snooping tcn query solicit
```

To disable Query Solicitation for vlan2, use the commands:

```
awplus# configure terminal  
awplus(config)# interface vlan2  
awplus(config-if)# no ip igmp snooping tcn query solicit
```

Related commands [ip igmp query-holdtime](#)
[show ip igmp interface](#)
[show running-config](#)

Command changes Version 5.4.7-1.1: VRF-lite support added SBx8100.
Version 5.4.8-1.1: VRF-lite support added x930, SBx908 GEN2.

ip igmp source-address-check

Overview This command enables the checking of the Source Address for an IGMP Report, rejecting any IGMP Reports originating on devices outside of the local subnet.

Use the **no** variant of this command to disable the checking of the Source Address for an IGMP Report, which allows IGMP Reports from devices outside of the local subnet.

Syntax `ip igmp source-address-check`
`no ip igmp source-address-check`

Default Source address checking for IGMP Reports is enabled by default.

Mode Interface Configuration for a VLAN or Eth interface.

Usage notes This is a security feature, and should be enabled unless IGMP Reports from outside the local subnet are expected, for example, if Multicast VLAN Registration is active in the network.

The no variant of this command is required to disable the IGMP Report source address checking feature in networks that use Multicast VLAN Registration to allow IGMP Reports from devices outside of the local subnet.

Examples To deny IGMP Reports from outside the current subnet for vlan20, use the following commands:

```
awplus# configure terminal
awplus(config)# interface vlan20
awplus(config-if)# ip igmp source-address-check
```

To allow IGMP Reports from outside the current subnet for vlan10, use the following commands:

```
awplus# configure terminal
awplus(config)# interface vlan10
awplus(config-if)# no ip igmp source-address-check
```

Related commands [show ip igmp interface](#)
[show running-config](#)

ip igmp startup-query-count

Overview Use this command to configure the IGMP startup query count for an interface. The IGMP startup query count is the number of IGMP General Query messages sent by a querier at startup. The default IGMP startup query count is 2.

Use the **no** variant of this command to return an interface's configured IGMP startup query count to the default.

Syntax `ip igmp startup-query-count <startup-query-count>`
`no ip igmp startup-query-count`

Parameter	Description
<code><startup-query-count></code>	Specify the IGMP startup query count, in the range 2-10.

Default The default IGMP startup query count is 2.

Mode Interface Configuration for a VLAN or Eth interface.

Example To set the IGMP startup query count to 4 on vlan2, use the commands:

```
awplus# configure terminal
awplus(config)# interface vlan2
awplus(config-if)# ip igmp startup-query-count 4
```

Related commands [ip igmp last-member-query-count](#)
[ip igmp startup-query-interval](#)

ip igmp startup-query-interval

Overview Use this command to configure the IGMP startup query interval for an interface. The IGMP startup query interval is the amount of time in seconds between successive IGMP General Query messages sent by a querier during startup. The default IGMP startup query interval is one quarter of the IGMP query interval value.

Use the **no** variant of this command to return an interface's configured IGMP startup query interval to the default.

Syntax `ip igmp startup-query-interval <startup-query-interval>`
`no ip igmp startup-query-interval`

Parameter	Description
<code><startup-query-interval></code>	Specify the IGMP startup query interval, in the range of 2-1800 seconds. The value must be one quarter of the IGMP query interval value.

Default The default IGMP startup query interval is one quarter of the IGMP query interval value.

NOTE: *The IGMP startup query interval must be one quarter of the IGMP query interval.*

Mode Interface Configuration for a VLAN or Eth interface.

Example To set the IGMP startup query interval to 15 seconds for vlan2, which is one quarter of the IGMP query interval of 60 seconds, use the commands:

```
awplus# configure terminal
awplus(config)# interface vlan2
awplus(config-if)# ip igmp query-interval 60
awplus(config-if)# ip igmp startup-query-interval 15
```

Related commands [ip igmp last-member-query-interval](#)
[ip igmp query-interval](#)
[ip igmp startup-query-count](#)

ip igmp trusted

Overview Use this command to allow IGMP to process packets received on certain trusted ports only.

Use the **no** variant of this command to stop IGMP from processing specified packets if the packets are received on the specified ports or aggregator.

Syntax `ip igmp trusted {all|query|report|routermode}`
`no ip igmp trusted {all|query|report|routermode}`

Parameter	Description
all	Specifies whether or not the interface is allowed to receive all IGMP and other routermode packets
query	Specifies whether or not the interface is allowed to receive IGMP queries
report	Specifies whether or not the interface is allowed to receive IGMP membership reports
routermode	Specifies whether or not the interface is allowed to receive routermode packets

Default By default, all ports and aggregators are trusted interfaces, so IGMP is allowed to process all IGMP query, report, and router mode packets arriving on all interfaces.

Mode Interface mode for one or more switch ports or aggregators

Usage Because all ports are trusted by default, use this command in its **no** variant to stop IGMP processing packets on ports you do not trust.

For example, you can use this command to make sure that only ports attached to approved IGMP routers are treated as router ports.

Example To stop ports port1.0.3-port1.0.6 from being treated as router ports by IGMP, use the commands:

```
awplus(config)# interface port1.0.3-port1.0.6  
awplus(config-if)# no ip igmp trusted routermode
```

Related commands [ip igmp snooping routermode](#)

ip igmp version

Overview Use this command to set the current IGMP version (IGMP version 1, 2 or 3) on an interface.

Use the **no** variant of this command to return to the default version.

Syntax `ip igmp version <1-3>`
`no ip igmp version`

Parameter	Description
<code>version <1-3></code>	IGMP protocol version number

Default The default IGMP version is 3.

Mode Interface Configuration for a VLAN or Eth interface.

Example To set the IGMP version to 2 for vlan2, use the commands:

```
awplus# configure terminal
awplus(config)# interface vlan2
awplus(config-if)# ip igmp version 2
```

Related commands [show ip igmp interface](#)

show debugging igmp

Overview Use this command to see what debugging is turned on for IGMP.

For information on filtering and saving command output, see the [“Getting Started with AlliedWare Plus” Feature Overview and Configuration Guide](#).

Syntax `show debugging igmp`

Mode User Exec and Privileged Exec

Example To display the IGMP debugging options set, enter the command:

```
awplus# show debugging igmp
```

Output Figure 34-1: Example output from the **show debugging igmp** command

```
IGMP Debugging status:
IGMP Decoder debugging is on
IGMP Encoder debugging is on
IGMP Events debugging is on
IGMP FSM debugging is on
IGMP Tree-Info-Base (TIB) debugging is on
```

Related commands [debug igmp](#)

Command changes Version 5.4.7-1.1: VRF-lite support added SBx8100.

Version 5.4.8-1.1: VRF-lite support added x930, SBx908 GEN2.

show ip igmp groups

Overview Use this command to display the multicast groups with receivers directly connected to the router, and learned through IGMP.

For information on filtering and saving command output, see the [“Getting Started with AlliedWare Plus” Feature Overview and Configuration Guide](#).

Syntax `show ip igmp groups [brief]`
`show ip igmp groups <ip-address> [detail]`
`show ip igmp groups <interface> [<ip-address>] [detail]`

Parameter	Description
<ip-address>	Address of the multicast group, entered in the form A.B.C.D.
<interface>	Interface name for which to display local information.
brief	Brief display of all interfaces.
detail	Detailed display of the interface.

Mode User Exec and Privileged Exec

Example The following command displays local-membership information for all ports in all interfaces:

```
awplus# show ip igmp groups
```

Output Figure 34-2: Example output from **show ip igmp groups**

IGMP Connected Group Membership				
Group Address	Interface	Uptime	Expires	Last Reporter
224.0.1.1	port1.0.1	00:00:09	00:04:17	10.10.0.82
224.0.1.24	port1.0.2	00:00:06	00:04:14	10.10.0.84
...				

Table 34-1: Parameters in the output of **show ip igmp groups**

Parameter	Description
Group Address	Address of the multicast group.
Interface	Port through which the group is reachable.
Uptime	The time in weeks, days, hours, minutes, and seconds that this multicast group has been known to the device.

Table 34-1: Parameters in the output of **show ip igmp groups** (cont.)

Parameter	Description
Expires	Time (in hours, minutes, and seconds) until the entry expires.
Last Reporter	Last host to report being a member of the multicast group.

Command changes

Version 5.4.7-1.1: VRF-lite support added SBx8100.

Version 5.4.8-1.1: VRF-lite support added x930, SBx908 GEN2.

Version 5.4.8-2.3: **brief** parameter added.

show ip igmp interface

Overview Use this command to display the state of IGMP, IGMP Proxy service, and IGMP Snooping for a specified VLAN, or all VLANs. IGMP is shown as Active or Disabled in the show output. You can also display the number of groups a switch port belongs to.

For information on filtering and saving command output, see the [“Getting Started with AlliedWare Plus” Feature Overview and Configuration Guide](#).

Syntax show ip igmp interface [<interface>]

Parameter	Description
<interface>	The name of the interface. If you specify a switch port number, the output displays the number of groups the port belongs to, and the port’s group membership limit, if a limit has been set (with the command <code>ip igmp maximum-groups</code>).

Mode User Exec and Privileged Exec

Output The following output shows IGMP interface status for vlan2 with IGMP Snooping enabled:

```
awplus#show ip igmp interface vlan2
Interface vlan2 (Index 202)
  IGMP Disabled, Inactive, Version 3 (default)
  IGMP interface has 0 group-record states
  IGMP activity: 0 joins, 0 leaves
  IGMP robustness variable is 2
  IGMP last member query count is 2
  IGMP query interval is 125 seconds
  IGMP query holdtime is 500 milliseconds
  IGMP querier timeout is 255 seconds
  IGMP max query response time is 10 seconds
  Last member query response interval is 1000 milliseconds
  Group Membership interval is 260 seconds
  Strict IGMPv3 ToS checking is disabled on this interface
  Source Address checking is enabled
  IGMP Snooping is globally enabled
  IGMP Snooping query solicitation is globally disabled
  Num. query-solicit packets: 57 sent, 0 recvd
  IGMP Snooping is enabled on this interface
  IGMP Snooping fast-leave is not enabled
  IGMP Snooping querier is not enabled
  IGMP Snooping report suppression is enabled
```

The following output shows IGMP interface status for vlan2 with IGMP Snooping disabled:

```
awplus#show ip igmp interface vlan2
Interface vlan2 (Index 202)
  IGMP Disabled, Inactive, Version 3 (default)
  IGMP interface has 0 group-record states
  IGMP activity: 0 joins, 0 leaves
  IGMP robustness variable is 2
  IGMP last member query count is 2
  IGMP query interval is 125 seconds
  IGMP query holdtime is 500 milliseconds
  IGMP querier timeout is 255 seconds
  IGMP max query response time is 10 seconds
  Last member query response interval is 1000 milliseconds
  Group Membership interval is 260 seconds
  Strict IGMPv3 ToS checking is disabled on this interface
  Source Address checking is enabled
  IGMP Snooping is globally enabled
  IGMP Snooping query solicitation is globally disabled
    Num. query-solicit packets: 57 sent, 0 recvd
  IGMP Snooping is not enabled on this interface
  IGMP Snooping fast-leave is not enabled
  IGMP Snooping querier is not enabled
  IGMP Snooping report suppression is enabled
```

The following output displays membership information for port1.0.1:

```
awplus#show ip igmp interface port1.0.1
IGMP information for port1.0.1
  Maximum groups limit set: 10
  Number of groups port belongs to: 0
```

**Command
changes**

Version 5.4.7-1.1: VRF-lite support added SBx8100.

Version 5.4.8-1.1: VRF-lite support added x930, SBx908 GEN2.

show ip igmp proxy

Overview Use this command to display the state of IGMP Proxy services for a specified interface or for all interfaces.

For information on filtering and saving command output, see the [“Getting Started with AlliedWare Plus” Feature Overview and Configuration Guide](#).

Syntax `show ip igmp proxy`

Mode User Exec and Privileged Exec

Example To display the state of IGMP Proxy services for all interfaces, enter the command:

```
awplus# show ip igmp proxy
```

Output Figure 34-3: Example output from **show ip igmp proxy**

```
awplus#show ip igmp proxy
Interface vlan40 (Index 340)
Administrative status: enabled
Operational status: up
Upstream interface is vlan30
Number of multicast groups: 1
```

Related commands [ip igmp proxy-service](#)

show ip igmp proxy groups

Overview Use this command to display multicast groups with receivers directly connected to the router, learned through IGMP, which use a proxy service. You can also use a filter to specify a multicast group IP address and /or interface.

For information on filtering and saving command output, see the [“Getting Started with AlliedWare Plus” Feature Overview and Configuration Guide](#).

Syntax show ip igmp proxy groups [detail]
show ip igmp proxy groups <multicast-group> [detail]
show ip igmp proxy groups <vlan> [detail]
show ip igmp proxy groups <vlan> <multicast-group> [detail]

Parameter	Description
groups	Specify IGMP proxy group membership information.
detail	Specify detailed IGMPv3 source information.
<vlan>	Specify the name of a single VLAN interface, for example vlan1 .
<multicast-group>	Specify the IPv4 address in of the multicast group, in the format A.B.C.D.

Mode User Exec

Example To display local membership information for IGMP proxy service interfaces, use the command:

```
awplus# show ip igmp proxy groups
```

Output Figure 34-4: Example output from **show ip igmp proxy groups**

```
awplus#show ip igmp proxy groups
IGMP Connected Proxy Group Membership
Group Address      Interface          Member state
224.9.10.11       vlan10            Delay
```

Example To display local membership information for IGMP proxy service interfaces, use the command:

```
awplus# show ip igmp proxy groups detail
```

Output Figure 34-5: Example output from **show ip igmp proxy groups detail**

```
awplus#show ip igmp proxy groups detail
Interface:      vlan10
Group:          224.9.10.11
Group mode:     Exclude
Member state:   Delay
Source list is empty

Summary :
IGMP Connected Proxy Group Membership
Group Address   Interface      Member state
224.9.10.11    vlan10        DelayDetail :
Interface:     vlan10
Group:         224.9.10.11
Group mode:    Exclude
Member state:  Delay
Source list is empty
```

Table 34-2: Parameters in the output of **show ip igmp proxy groups**

Parameter	Description
Interface	The interface that received the IGMP report.
Group	The multicast group address that has been requested by the IGMP report.
Group mode	Include mode indicates that the multicast receiver has sent an IGMPv3 report for a group with a list of addresses that it wants to receive traffic from. Exclude mode indicates that the multicast receiver has sent an IGMPv3 report for a group with a list of addresses that it does not want to receive traffic from.
Member state	Delay indicates that no group or source query timers are running for the specified group, otherwise the member state is shown as Idle .

Related commands [show ip igmp proxy](#)

Command changes
Version 5.4.7-1.1: VRF-lite support added SBx8100.
Version 5.4.8-1.1: VRF-lite support added x930, SBx908 GEN2.

show ip igmp snooping mrouter

Overview Use this command to display the multicast router ports, both static and dynamic, in a VLAN.

For information on filtering and saving command output, see the [“Getting Started with AlliedWare Plus” Feature Overview and Configuration Guide](#).

Syntax `show ip igmp snooping mrouter [interface <interface>]`

Parameter	Description
<code>interface</code>	A specific interface.
<code><interface></code>	The name of the VLAN interface.

Mode User Exec and Privileged Exec

Example To show all multicast router interfaces, use the command:

```
awplus# show ip igmp snooping mrouter
```

To show the multicast router interfaces in `vlan1`, use the command:

```
awplus# show ip igmp snooping mrouter interface vlan1
```

Output Figure 34-6: Example output from **show ip igmp snooping mrouter**

VLAN	Interface	Static/Dynamic
1	port1.0.1	Statically configured
200	port1.0.2	Statically configured

Figure 34-7: Example output from **show ip igmp snooping mrouter interface vlan1**

VLAN	Interface	Static/Dynamic
1	port1.0.1	Statically configured

Related commands [ip igmp snooping mrouter](#)

Command changes Version 5.4.7-1.1: VRF-lite support added SBx8100.

Version 5.4.8-1.1: VRF-lite support added x930, SBx908 GEN2.

show ip igmp snooping routermode

Overview Use this command to display the current router mode and the list of IP addresses set as router multicast addresses from the [ip igmp snooping routermode](#) command.

For information on filtering and saving command output, see the [“Getting Started with AlliedWare Plus” Feature Overview and Configuration Guide](#).

Syntax `show ip igmp snooping routermode`

Mode User Exec and Privileged Exec

Example To show the router mode and the list of router multicast addresses, use the command:

```
awplus# show ip igmp snooping routermode
```

Output Figure 34-8: Example output from **show ip igmp snooping routermode**

```
awplus#show ip igmp snooping routermode
Router mode.....Def
Reserved multicast address

      224.0.0.1
      224.0.0.2
      224.0.0.4
      224.0.0.5
      224.0.0.6
      224.0.0.9
      224.0.0.13
      224.0.0.15
      224.0.0.24
```

Related commands [ip igmp snooping routermode](#)

Command changes Version 5.4.7-1.1: VRF-lite support added SBx8100.

Version 5.4.8-1.1: VRF-lite support added x930, SBx908 GEN2.

show ip igmp snooping source-timeout

Overview Use this command to display the configured IGMP snooping source timeouts for a specified VLAN or VLAN range.

Syntax `show ip igmp snooping source-timeout [interface|<interface-range>]`

Parameter	Description
<interface-range>	The name of the VLAN interface or VLAN range

Mode Privileged Exec

Example To display the configured IGMP snooping source timeouts for all VLANs, use the command:

```
awplus# show ip igmp snooping source-timeout
```

Output Figure 34-9: Example output from **show ip igmp snooping source-timeout**

```
awplus#show ip igmp snooping source-timeout
Global IGMP snooping source-timeout is enabled (60 secs)

vlan1          enabled (300 secs)
vlan2          inherits global setting
vlan1000       inherits global settingawplus#show ip igmp
snooping source-timeout int vlan1
Global IGMP snooping source-timeout is enabled (60 secs)vlan1
enabled (300 secs)
```

Related commands [ip igmp snooping source-timeout](#)

Command changes Version 5.4.7-1.1: VRF-lite support added SBx8100.

Version 5.4.8-1.1: VRF-lite support added x930, SBx908 GEN2.

show ip igmp snooping statistics

Overview Use this command to display IGMP Snooping statistics data.

For information on filtering and saving command output, see the [“Getting Started with AlliedWare Plus” Feature Overview and Configuration Guide](#).

Syntax `show ip igmp snooping statistics interface <interface-range> [group [<ip-address>]]`

Parameter	Description
<ip-address>	Optionally specify the address of the multicast group, entered in the form A.B.C.D.
<interface>	Specify the name of the interface or interface range. If you specify a port number, the output displays the number of groups the port belongs to, and the port’s group membership limit, if a limit has been set (with the command <code>ip igmp maximum-groups</code>)

Mode Privileged Exec

Example To display IGMP statistical information for **vlan1** and **vlan2**, use the command:

```
awplus# show ip igmp snooping statistics interface vlan1-vlan2
```

Output Figure 34-10: Example output from the **show ip igmp snooping statistics** command for VLANs

```
awplus#show ip igmp interface vlan1-vlan2
IGMP Snooping statistics for vlan1
Interface:      port1.0.1
Group:         224.1.1.1
Uptime:        00:00:09
Group mode:    Exclude (Expires: 00:04:10)
Last reporter: 10.4.4.5
Source list is empty
IGMP Snooping statistics for vlan2
Interface:      port1.0.2
Group:         224.1.1.2
Uptime:        00:00:19
Group mode:    Exclude (Expires: 00:05:10)
Last reporter: 10.4.4.6
Source list is empty
```

Figure 34-11: Example output from the **show ip igmp snooping statistics** command for a switch port

```
awplus#show ip igmp interface port1.0.1
IGMP information for port1.0.1
  Maximum groups limit set: 10
  Number of groups port belongs to: 0
```

**Command
changes**

Version 5.4.7-1.1: VRF-lite support added SBx8100.

Version 5.4.8-1.1: VRF-lite support added x930, SBx908 GEN2.

undebug igmp

Overview This command applies the functionality of the no `debug igmp` command.

35

MLD and MLD Snooping Commands

Introduction

Overview This chapter provides an alphabetical reference of configuration, clear, and show commands related to MLD and MLD Snooping.

The Multicast Listener Discovery (MLD) module includes the MLD Proxy service and MLD Snooping functionality. Some of the following commands may have commonalities and restrictions; these are described under the Usage section for each command.

MLD and MLD Snooping commands only apply to switch ports, not Ethernet interfaces.

Before using PIM-SMv6:

- IPv6 must be enabled on an interface ([ipv6 enable](#)),
- IPv6 forwarding must be enabled globally for routing IPv6 ([ipv6 forwarding](#)), and
- IPv6 multicasting must be enabled globally ([ipv6 multicast-routing](#)).

- Command List**
- [“clear ipv6 mld”](#) on page 1838
 - [“clear ipv6 mld group”](#) on page 1839
 - [“clear ipv6 mld interface”](#) on page 1840
 - [“debug mld”](#) on page 1841
 - [“ipv6 mld”](#) on page 1842
 - [“ipv6 mld last-member-query-count”](#) on page 1843
 - [“ipv6 mld last-member-query-interval”](#) on page 1844
 - [“ipv6 mld querier-timeout”](#) on page 1845
 - [“ipv6 mld query-interval”](#) on page 1846
 - [“ipv6 mld query-max-response-time”](#) on page 1847
 - [“ipv6 mld robustness-variable”](#) on page 1848

- [“ipv6 mld snooping”](#) on page 1849
- [“ipv6 mld snooping fast-leave”](#) on page 1851
- [“ipv6 mld snooping mrouter”](#) on page 1852
- [“ipv6 mld snooping querier”](#) on page 1854
- [“ipv6 mld snooping report-suppression”](#) on page 1855
- [“ipv6 mld ssm-map enable”](#) on page 1857
- [“ipv6 mld static-group”](#) on page 1858
- [“ipv6 mld version”](#) on page 1860
- [“show debugging mld”](#) on page 1861
- [“show ipv6 mld groups”](#) on page 1862
- [“show ipv6 mld interface”](#) on page 1863
- [“show ipv6 mld snooping mrouter”](#) on page 1864
- [“show ipv6 mld snooping statistics”](#) on page 1865

clear ipv6 mld

Overview Use this command to clear all MLD local memberships on all interfaces.

Syntax `clear ipv6 mld`

Mode Privileged Exec

Usage This command applies to interfaces configured for MLD Layer 3 multicast protocols and learned by MLD Snooping.

Example To clear all MLD local memberships on all interfaces, use the command:

```
awplus# clear ipv6 mld
```

Related commands [clear ipv6 mld group](#)
[clear ipv6 mld interface](#)

clear ipv6 mld group

Overview Use this command to clear MLD specific local-membership(s) on all interfaces, for a particular group.

Syntax `clear ipv6 mld group {*|<ipv6-address>}`

Parameter	Description
*	Clears all groups on all interfaces. This is an alias to the clear ipv6 mld command.
<ipv6-address>	Specify the group address for which MLD local-memberships are to be cleared from all interfaces. Specify the IPv6 multicast group address in the format in the format X:X::X:X.

Mode Privileged Exec

Usage This command applies to interfaces configured for MLD Layer 3 multicast protocols and learned by MLD Snooping.

Example To clear all groups on all interfaces, use the command:

```
awplus# clear ipv6 mld group *
```

Related commands [clear ipv6 mld](#)
[clear ipv6 mld interface](#)

clear ipv6 mld interface

Overview Use this command to clear MLD interface entries.

Syntax `clear ipv6 mld interface <interface>`

Parameter	Description
<code><interface></code>	Specifies name of the interface; all groups learned from this interface are deleted.

Mode Privileged Exec

Usage This command applies to interfaces configured for MLD Layer 3 multicast protocols and learned by MLD Snooping.

Example To clear the entries from vlan2, use the command:

```
awplus# clear ipv6 mld interface vlan2
```

Related commands [clear ipv6 mld](#)
[clear ipv6 mld group](#)

debug mld

Overview Use this command to enable all MLD debugging modes, or a specific MLD debugging mode.

Use the **no** variant of this command to disable all MLD debugging modes, or a specific MLD debugging mode.

Syntax `debug mld {all|decode|encode|events|fsm|tib}`
`no debug mld {all|decode|encode|events|fsm|tib}`

Parameter	Description
all	Debug all MLD.
decode	Debug MLD decoding.
encode	Debug MLD encoding.
events	Debug MLD events.
fsm	Debug MLD Finite State Machine (FSM).
tib	Debug MLD Tree Information Base (TIB).

Mode Privileged Exec and Global Configuration

Usage notes This command applies to interfaces configured for MLD Layer 3 multicast protocols and learned by MLD Snooping.

Examples

```
awplus# configure terminal
awplus(config)# debug mld all
awplus# configure terminal
awplus(config)# debug mld decode
awplus# configure terminal
awplus(config)# debug mld encode
awplus# configure terminal
awplus(config)# debug mld events
```

Related commands [show debugging mld](#)

ipv6 mld

Overview Use this command to enable the MLD protocol operation on an interface. This command enables MLD protocol operation in stand-alone mode, and can be used to learn local-membership information prior to enabling a multicast routing protocol on the interface.

Use the **no** variant of this command to return all MLD related configuration to the default (including MLD Snooping).

Syntax `ipv6 mld`
`no ipv6 mld`

Default MLD is disabled by default.

Mode Interface Configuration for a specified VLAN interface or a range of VLAN interfaces.

Usage notes MLD requires memory for storing data structures, as well as the hardware tables to implement hardware routing. As the number of ports, VLANs, static and dynamic groups increases then more memory is consumed. You can track the memory used for MLD with the command:

```
awplus# show memory pools nsm | grep MLD
```

Static and dynamic groups (LACP), ports and VLANs are not limited for MLD. For VLANs, this allows you to configure MLD across more VLANs with fewer ports per VLAN, or fewer VLANs with more ports per VLAN. For LACPs, you can configure MLD across more LACP groups with fewer ports per LACP, or fewer LACP groups with more ports per LACP.

Example To enable MLD on vlan1, use the commands:

```
awplus# configure terminal
awplus(config)# ipv6 forwarding
awplus(config)# ipv6 multicast-routing
awplus(config)# interface vlan1
awplus(config-if)# ipv6 enable
awplus(config-if)# ipv6 mld
```

Related commands [show ipv6 mld interface](#)

ipv6 mld last-member-query-count

Overview Use this command to set the last-member query-count value.
Use the **no** variant of this command to return to the default on an interface.

Syntax `ipv6 mld last-member-query-count <value>`
`no ipv6 mld last-member-query-count`

Parameter	Description
<value>	Count value. Valid values are from 2 to 7.

Default The default last-member query-count value is 2.

Mode Interface Configuration for a specified VLAN interface or a range of VLAN interfaces.

Example To set the last-member query-count to 3 on vlan2, use the commands:

```
awplus# configure terminal
awplus(config)# ipv6 forwarding
awplus(config)# ipv6 multicast-routing
awplus(config)# interface vlan2
awplus(config-if)# ipv6 enable
awplus(config-if)# ipv6 mld last-member-query-count 3
```

ipv6 mld last-member-query-interval

Overview Use this command to configure the interval at which the router sends MLD group-specific host query messages.

Use the **no** variant of this command to set this frequency to the default.

Syntax `ipv6 mld last-member-query-interval <milliseconds>`
`no ipv6 mld last-member-query-interval`

Parameter	Description
<code><milliseconds></code>	The time delay between successive query messages (in milliseconds). Valid values are from 1000 to 25500 milliseconds.

Default 1000 milliseconds

Mode Interface Configuration for a specified VLAN interface or a range of VLAN interfaces.

Example The following example changes the MLD group-specific host query message interval to 2 seconds:

```
awplus# configure terminal
awplus(config)# ipv6 forwarding
awplus(config)# ipv6 multicast-routing
awplus(config)# interface vlan2
awplus(config-if)# ipv6 enable
awplus(config-if)# ipv6 mld last-member-query-interval 2000
```

ipv6 mld querier-timeout

Overview Use this command to configure the timeout period before the router takes over as the querier for the interface after the previous querier has stopped querying.

Use the **no** variant of this command to restore the default.

Syntax `ipv6 mld querier-timeout <seconds>`
`no ipv6 mld querier-timeout`

Parameter	Description
<code><seconds></code>	Number of seconds that the router waits after the previous querier has stopped querying before it takes over as the querier. Valid values are from 2 to 65535 seconds.

Default 255 seconds

Mode Interface Configuration for a specified VLAN interface or a range of VLAN interfaces.

Usage notes This command applies to interfaces configured for MLD Layer 3 multicast protocols.

Example The following example configures the router to wait 120 seconds from the time it received the last query before it takes over as the querier for the interface:

```
awplus# configure terminal
awplus(config)# ipv6 forwarding
awplus(config)# ipv6 multicast-routing
awplus(config)# interface vlan2
awplus(config-if)# ipv6 enable
awplus(config-if)# ipv6 mld querier-timeout 120
```

Related commands [ipv6 mld query-interval](#)

ipv6 mld query-interval

Overview Use this command to configure the frequency of sending MLD host query messages.

Use the **no** variant of this command to return to the default frequency.

Syntax `ipv6 mld query-interval <seconds>`
`no ipv6 mld query-interval`

Parameter	Description
<code><seconds></code>	Variable that specifies the time delay between successive MLD host query messages (in seconds). Valid values are from 1 to 18000 seconds.

Default The default query interval is 125 seconds.

Mode Interface Configuration for a specified VLAN interface or a range of VLAN interfaces.

Usage This command applies to interfaces configured for MLD Layer 3 multicast protocols.

Example The following example changes the frequency of sending MLD host-query messages to 2 minutes:

```
awplus# configure terminal
awplus(config)# ipv6 forwarding
awplus(config)# ipv6 multicast-routing
awplus(config)# interface vlan2
awplus(config-if)# ipv6 enable
awplus(config-if)# ipv6 mld query-interval 120
```

Related commands [ipv6 mld querier-timeout](#)

ipv6 mld query-max-response-time

Overview Use this command to configure the maximum response time advertised in MLD queries.

Use the **no** variant of with this command to restore the default.

Syntax `ipv6 mld query-max-response-time <seconds>`
`no ipv6 mld query-max-response-time`

Parameter	Description
<code><seconds></code>	Maximum response time (in seconds) advertised in MLD queries. Valid values are from 1 to 240 seconds.

Default 10 seconds

Mode Interface Configuration for a specified VLAN interface or a range of VLAN interfaces.

Usage This command applies to interfaces configured for MLD Layer 3 multicast protocols.

Example The following example configures a maximum response time of 8 seconds:

```
awplus# configure terminal
awplus(config)# ipv6 forwarding
awplus(config)# ipv6 multicast-routing
awplus(config)# interface vlan2
awplus(config-if)# ipv6 enable
awplus(config-if)# ipv6 mld query-max-response-time 8
```

ipv6 mld robustness-variable

Overview Use this command to change the robustness variable value on an interface.
Use the **no** variant of this command to return to the default on an interface.

Syntax `ipv6 mld robustness-variable <value>`
`no ipv6 mld robustness-variable`

Parameter	Description
<value>	Valid values are from 1 to 7.

Default The default robustness variable value is 2.

Mode Interface Configuration for a specified VLAN interface or a range of VLAN interfaces.

Usage This command applies to interfaces configured for MLD Layer 3 multicast protocols.

Example The following example changes the robustness variable value to 3:

```
awplus# configure terminal
awplus(config)# ipv6 forwarding
awplus(config)# ipv6 multicast-routing
awplus(config)# interface vlan2
awplus(config-if)# ipv6 enable
awplus(config-if)# ipv6 mld robustness-variable 3
```

ipv6 mld snooping

Overview Use this command to enable MLD Snooping. When this command is issued in the Global Configuration mode, MLD Snooping is enabled globally for the device. When this command is issued in Interface mode for a VLAN then MLD Snooping is enabled for the specified VLAN. Note that MLD Snooping is enabled on the VLAN only if it is enabled globally and on the VLAN.

Use the **no** variant of this command to globally disable MLD Snooping in Global Configuration mode, or for the specified VLAN interface in Interface mode.

Syntax `ipv6 mld snooping`
`no ipv6 mld snooping`

Default By default, MLD Snooping is enabled both globally and on all VLANs.

Mode Global Configuration and Interface Configuration for a specified VLAN interface or a range of VLAN interfaces.

Usage notes For MLD Snooping to operate on particular VLAN interfaces, it must be enabled both globally by using this command in Global Configuration mode, and on individual VLAN interfaces by using this command in Interface Configuration mode (both are enabled by default).

MLD requires memory for storing data structures, as well as the hardware tables to implement hardware routing. As the number of ports, VLANs, static and dynamic groups increases then more memory is consumed. You can track the memory used for MLD with the command:

```
awplus# show memory pools nsm | grep MLD
```

Static and dynamic groups (LACP), ports and VLANs are not limited for MLD. For VLANs, this allows you to configure MLD across more VLANs with fewer ports per VLAN, or fewer VLANs with more ports per VLAN. For LACPs, you can configure MLD across more LACP groups with fewer ports per LACP, or fewer LACP groups with more ports per LACP.

Examples To configure MLD Snooping on the VLAN interfaces `vlan2-vlan4`, enter the following commands:

```
awplus# configure terminal
awplus(config)# interface vlan2-vlan4
awplus(config-if)# ipv6 mld snooping
```

To disable MLD Snooping for the VLAN interfaces `vlan2-vlan4`, enter the following commands:

```
awplus# configure terminal
awplus(config)# interface vlan2-vlan4
awplus(config)# no ipv6 mld snooping
```

To configure MLD Snooping globally for the device, enter the following commands:

```
awplus# configure terminal  
awplus(config)# ipv6 mld snooping
```

To disable MLD Snooping globally for the device, enter the following commands:

```
awplus# configure terminal  
awplus(config)# no ipv6 mld snooping
```

ipv6 mld snooping fast-leave

Overview Use this command to enable MLD Snooping fast-leave processing. Fast-leave processing is analogous to immediate-leave processing; the MLD group-membership is removed as soon as an MLD leave group message is received, without sending out a group-specific query.

Use the **no** variant of this command to disable fast-leave processing.

Syntax `ipv6 mld snooping fast-leave`
`no ipv6 mld snooping fast-leave`

Default MLD Snooping fast-leave processing is disabled.

Mode Interface Configuration for a specified VLAN interface or a range of VLAN interfaces.

Usage notes This MLD Snooping command can only be configured on VLAN interfaces.

Examples This example shows how to enable fast-leave processing on the VLAN interface `vlan2`.

```
awplus# configure terminal
awplus(config)# interface vlan2
awplus(config-if)# ipv6 mld snooping fast-leave
```

This example shows how to enable fast-leave processing on the VLAN interface `vlan2-vlan4`.

```
awplus# configure terminal
awplus(config)# interface vlan2-vlan4
awplus(config-if)# ipv6 mld snooping fast-leave
```

ipv6 mld snooping mrrouter

Overview Use this command to statically configure the specified port as a Multicast Router interface for MLD Snooping within the specified VLAN.

See detailed usage notes below to configure static multicast router ports when using static IPv6 multicast routes with EPSR, and the destination VLAN is an EPSR data VLAN.

Use the **no** variant of this command to remove the static configuration of the interface as a Multicast Router interface.

Syntax `ipv6 mld snooping mrrouter interface <port>`
`no ipv6 mld snooping mrrouter interface <port>`

Parameter	Description
<port>	Specify the name of the port.

Mode Interface Configuration for a specified VLAN interface or a range of VLAN interfaces.

Usage notes This MLD Snooping command statically configures a switch port as a Multicast Router interface.

Note that if static IPv6 multicast routing is being used with EPSR and the destination VLAN is an EPSR data VLAN, then multicast router (mrrouter) ports must be statically configured. This minimizes disruption for multicast traffic in the event of ring failure or restoration.

When configuring the EPSR data VLAN, statically configure mrrouter ports so that the multicast router can be reached in either direction around the EPSR ring.

For example, if port1.0.1 and port1.0.6 are ports on an EPSR data VLAN vlan101, which is the destination for a static IPv6 multicast route, then configure both ports as multicast router (mrrouter) ports as shown in the example commands listed below:

Figure 35-1: Example **ipv6 mld snooping mrrouter** commands when static IPv6 multicast routing is being used and the destination VLAN is an EPSR data VLAN:

```
awplus>enable
awplus#configure terminal
awplus(config)#interface vlan101
awplus(config-if)#ipv6 mld snooping mrrouter interface port1.0.1
awplus(config-if)#ipv6 mld snooping mrrouter interface port1.0.6
```

Examples This example shows how to specify the next-hop interface to the multicast router for VLAN interface `vlan2`:

```
awplus# configure terminal
awplus(config)# interface vlan2
awplus(config-if)# ipv6 mld snooping mrrouter interface
port1.0.5
```

This example shows how to specify the next-hop interface to the multicast router for VLAN interfaces `vlan2-vlan4`:

```
awplus# configure terminal
awplus(config)# interface vlan2-vlan4
awplus(config-if)# ipv6 mld snooping mrrouter interface
port1.0.5
```

Related commands [ipv6 multicast route](#)

ipv6 mld snooping querier

Overview Use this command to enable MLD querier operation on a subnet (VLAN) when no multicast routing protocol is configured in the subnet (VLAN). When enabled, the MLD Snooping querier sends out periodic MLD queries for all interfaces on that VLAN.

Use the **no** variant of this command to disable MLD querier configuration.

Syntax `ipv6 mld snooping querier`
`no ipv6 mld snooping querier`

Mode Interface Configuration for a specified VLAN interface.

Usage This command can only be configured on a single VLAN interface - not on multiple VLANs.

The MLD Snooping querier uses the 0.0.0.0 Source IP address because it only masquerades as an MLD querier for faster network convergence.

The MLD Snooping querier does not start, or automatically cease, the MLD Querier operation if it detects query message(s) from a multicast router. It restarts as an MLD Snooping querier if no queries are seen within the other querier interval.

Do not enable MLD Snooping querier if you have already enabled MLD on your device.

Do not enable MLD Snooping querier on your device and then enable MLD afterwards.

Example

```
awplus# configure terminal
awplus(config)# interface vlan2
awplus(config-if)# ipv6 mld snooping querier
```

ipv6 mld snooping report-suppression

Overview Use this command to enable report suppression from hosts for Multicast Listener Discovery version 1 (MLDv1) on a VLAN in Interface Configuration mode.

Use the **no** variant of this command to disable report suppression on a VLAN in Interface Configuration mode.

Syntax `ipv6 mld snooping report-suppression`
`no ipv6 mld snooping report-suppression`

Default Report suppression does not apply to MLDv2, and is turned on by default for MLDv1 reports.

Mode Interface Configuration for a specified VLAN interface or a range of VLAN interfaces.

Usage This MLD Snooping command can only be configured on VLAN interfaces. MLDv1 Snooping maybe configured to suppress reports from hosts. When a querier sends a query, only the first report for particular set of group(s) from a host will be forwarded to the querier by the MLD Snooping device. Similar reports (to the same set of groups) from other hosts, which would not change group memberships in the querier, will be suppressed by the MLD Snooping device to prevent 'flooding' of query responses.

Examples This example shows how to enable report suppression for MLD reports on VLAN interface `vlan2`:

```
awplus# configure terminal
awplus(config)# interface vlan2
awplus(config-if)# ipv6 mld snooping report-suppression
```

This example shows how to disable report suppression for MLD reports on VLAN interface `vlan2`:

```
awplus# configure terminal
awplus(config)# interface vlan2
awplus(config-if)# no ipv6 mld snooping report-suppression
```

This example shows how to enable report suppression for MLD reports on VLAN interfaces `vlan2-vlan4`:

```
awplus# configure terminal
awplus(config)# interface vlan2-vlan4
awplus(config-if)# ipv6 mld snooping report-suppression
```

This example shows how to disable report suppression for MLD reports on VLAN interfaces `vlan2-vlan4`:

```
awplus# configure terminal
awplus(config)# interface vlan2-vlan4
awplus(config-if)# no ipv6 mld snooping report-suppression
```

ipv6 mld ssm-map enable

Overview Use this command to enable the Source Specific Multicast (SSM) mapping feature on the device.

Use the **no** variant of this command to disable the SSM mapping feature on the device.

Syntax `ipv6 mld ssm-map enable`
`no ipv6 mld ssm-map enable`

Mode Global Configuration

Usage notes This command enables the SSM mapping feature for group members in the defined SSM range.

Example This example shows how to enable the MLD SSM mapping feature on the device.

```
awplus# configure terminal
awplus(config)# ipv6 mld ssm-map enable
```

ipv6 mld static-group

Overview Use this command to statically configure IPv6 group membership entries on an interface. To statically add only a group membership, do not specify any parameters.

Use the **no** variant of this command to delete static group membership entries.

Syntax `ipv6 mld static-group <ipv6-group-address> [source <ipv6-source-address>] [interface <port>]`
`no ipv6 mld static-group <ipv6-group-address> [source <ipv6-source-address>] [interface <port>]`

Parameter	Description
<code><ipv6-group-address></code>	Specify a standard IPv6 Multicast group address to be configured as a static group member. The IPv6 address uses the format X:X::X:X.
<code><ipv6-source-address></code>	Optional. Specify a standard IPv6 source address to be configured as a static source from where multicast packets originate. The IPv6 address uses the format X:X::X:X.
<code><port></code>	Optional. Physical interface. This parameter specifies a physical port. If this parameter is used, the static configuration is applied to just that physical interface. If this parameter is not used, the static configuration is applied on all interfaces in the group.

Mode Interface Configuration for a specified VLAN interface.

Usage notes This command applies to MLD Snooping on a VLAN interface to statically add groups and/or source records.

Examples To add a static group record, use the following commands:

```
awplus# configure terminal
awplus(config)# interface vlan2
awplus(config-if)# ipv6 mld static-group ff1e::10
```

To add a static group and source record, use the following commands:

```
awplus# configure terminal
awplus(config)# interface vlan2
awplus(config-if)# ipv6 mld static-group ff1e::10 source
fe80::2fd:6cff:fe1c:b
```

To add a static group record on a specific port on vlan2, use the following commands:

```
awplus# configure terminal
awplus(config)# interface vlan2
awplus(config-if)# ipv6 mld static-group ff1e::10 interface
port1.0.8
```

ipv6 mld version

Overview Use this command to set the current MLD protocol version on an interface.
Use the **no** variant of this command to return to the default version on an interface.

Syntax `ipv6 mld version <version>`
`no ipv6 mld version`

Parameter	Description
<version>	MLD protocol version number. Valid version numbers are 1 and 2

Default The default MLD protocol version number is 2.

Mode Interface Configuration for a specified VLAN interface.

Usage notes This command applies to interfaces configured for MLD Layer 3 multicast protocols and MLD Snooping.

Note this command is intended for use where there is another querier (when there is another device with MLD enabled) on the same link that can only operate with MLD version 1. Otherwise, the default MLD version 2 is recommended for performance.

Example To set the MLD protocol version to 1, use the following commands:

```
awplus# configure terminal
awplus(config)# ipv6 forwarding
awplus(config)# ipv6 multicast-routing
awplus(config)# interface vlan2
awplus(config-if)# ipv6 enable
awplus(config-if)# ipv6 mld version 1
```

show debugging mld

Overview Use this command to see what debugging is turned on for MLD. MLD debugging modes are enabled with the [debug mld](#) command.

For information on filtering and saving command output, see the [“Getting_Started with AlliedWare Plus” Feature Overview and Configuration_Guide](#).

Syntax `show debugging mld`

Mode Privileged Exec

Example `awplus# show debugging mld`

Output

```
show debugging mld
MLD Debugging status:
  MLD Decoder debugging is on
  MLD Encoder debugging is on
  MLD Events debugging is on
  MLD FSM debugging is on
  MLD Tree-Info-Base (TIB) debugging is on
```

Related commands [debug mld](#)

show ipv6 mld groups

Overview Use this command to display the multicast groups that have receivers directly connected to the router and learned through MLD.

For information on filtering and saving command output, see the [“Getting Started with AlliedWare Plus” Feature Overview and Configuration Guide](#).

Syntax `show ipv6 mld groups [<ipv6-address>|<interface>] [detail]`

Parameter	Description
<ipv6-address>	Optional. Specify Address of the multicast group in format X:X::X:X.
<interface>	Optional. Specify the Interface name for which to display local information.

Mode User Exec and Privileged Exec

Examples The following command displays local-membership information for all interfaces:

```
awplus# show ipv6 mld groups
```

Output Figure 35-2: Example output for **show ipv6 mld groups**

```
awplus#show ipv6 mld groups
MLD Connected Group Membership
Group Address      Interface                Uptime   Expires   Last Reporter
ff08::1           vlan10 (port1.0.1)      00:07:27 00:03:10  fe80::200:1ff:fe20:b5ac
```

The following command displays local-membership information for all interfaces:

```
awplus# show ipv6 mld groups detail
```

Figure 35-3: Example output for **show ipv6 mld groups detail**

```
awplus# show ipv6 mld groups detail
MLD Connected Group Membership Details for port1.0.1
Interface:        port1.0.1
Group:            ff08::1
Uptime:           00:00:13
Group mode:       Include ()
Last reporter:    fe80::eecd:6dff:fe6b:4783
Group source list: (R - Remote, M - SSM Mapping, S - Static )
  Source Address      Uptime   v2 Exp   Fwd  Flags
  2001:db8::1         00:00:13 00:04:07 Yes  R
  2002:db8::3         00:00:13 00:04:07 Yes  R
```

show ipv6 mld interface

Overview Use this command to display the state of MLD and MLD Snooping for a specified interface, or all interfaces.

For information on filtering and saving command output, see the [“Getting Started with AlliedWare Plus” Feature Overview and Configuration Guide](#).

Syntax `show ipv6 mld interface [<interface>]`

Parameter	Description
<interface>	Interface name.

Mode User Exec and Privileged Exec

Example The following command displays MLD interface status on all interfaces enabled for MLD:

```
awplus# show ipv6 mld interface
```

Output Figure 35-4: Example output for **show ipv6 mld interface**

```
awplus#show ipv6 mld interface

Interface vlan1 (Index 301)
  MLD Enabled, Active, Querier, Version 2 (default)
  Internet address is fe80::215:77ff:fec9:7468
  MLD interface has 0 group-record states
  MLD activity: 0 joins, 0 leaves
  MLD robustness variable is 2
  MLD last member query count is 2
  MLD query interval is 125 seconds
  MLD querier timeout is 255 seconds
  MLD max query response time is 10 seconds
  Last member query response interval is 1000 milliseconds
  Group Membership interval is 260 seconds
  MLD Snooping is globally enabled
  MLD Snooping is enabled on this interface
  MLD Snooping fast-leave is not enabled
  MLD Snooping querier is enabled
  MLD Snooping report suppression is enabled
```

show ipv6 mld snooping mrouter

Overview Use this command to display the multicast router interfaces, both configured and learned, in a VLAN. If you do not specify a VLAN interface then all the VLAN interfaces are displayed.

For information on filtering and saving command output, see the [“Getting Started with AlliedWare Plus” Feature Overview and Configuration Guide](#).

Syntax `show ipv6 mld snooping mrouter [<interface>]`

Parameter	Description
<interface>	Optional. Specify the name of the VLAN interface. Note: If you do not specify a single VLAN interface, then all VLAN interfaces are shown.

Mode User Exec and Privileged Exec

Examples The following command displays the multicast router interfaces in `vlan2`:

```
awplus# show ipv6 mld snooping mrouter vlan2
```

Output

```
awplus#show ipv6 mld snooping mrouter vlan2
VLAN      Interface      Static/Dynamic
2         port1.0.2     Dynamically Learned
2         port1.0.3     Dynamically Learned
```

The following command displays the multicast router interfaces for all VLAN interfaces:

```
awplus# show ipv6 mld snooping mrouter
```

Output

```
awplus#show ipv6 mld snooping mrouter
VLAN      Interface      Static/Dynamic
2         port1.0.2     Dynamically Learned
2         port1.0.3     Dynamically Learned
3         port1.0.4     Statically Assigned
3         port1.0.5     Statically Assigned
```

show ipv6 mld snooping statistics

Overview Use this command to display MLD Snooping statistics data.

For information on filtering and saving command output, see the [“Getting Started with AlliedWare Plus”_Feature Overview and Configuration Guide](#).

Syntax `show ipv6 mld snooping statistics interface <interface>`

Parameter	Description
<interface>	The name of the VLAN interface.

Mode User Exec and Privileged Exec

Example The following command displays MLDv2 statistical information for vln1:

```
awplus# show ipv6 mld snooping statistics interface vln1
```

Output

```
awplus#show ipv6 mld snooping statistics interface vln1
MLD Snooping statistics for vln1
Interface:      port1.0.1
Group:         ff08::1
Uptime:        00:02:18
Group mode:    Include ()
Last reporter: fe80::eecd:6dff:fe6b:4783
Group source list: (R - Remote, M - SSM Mapping, S - Static )
  Source Address      Uptime      v2 Exp      Fwd  Flags
  2001:db8::1        00:02:18    00:02:02   Yes  R
  2001:db8::3        00:02:18    00:02:02   Yes  R
```

36

Multicast Commands

Introduction

Overview This chapter provides an alphabetical reference of multicast commands for configuring:

- IPv4 and IPv6 multicast forwarding
- IPv4 and IPv6 static multicast routes
- mroutes (routes back to a multicast source)

For commands for other multicast protocols, see:

- [IGMP and IGMP Snooping Commands](#)
- [MLD and MLD Snooping Commands](#)
- [PIM-SM Commands](#)
- [PIM-SMv6 Commands](#)

NOTE: Before using PIM-SMv6 commands, IPv6 must be enabled on an interface with the *ipv6 enable* command, IPv6 forwarding must be enabled globally for routing IPv6 with the *ipv6 forwarding* command, and IPv6 multicasting must be enabled globally with the *ipv6 multicast-routing* command.

Static IPv6 multicast routes take priority over dynamic IPv6 multicast routes. Use the *clear ipv6 mroute* command to clear static IPv6 multicast routes and ensure dynamic IPv6 multicast routes can take over from previous static IPv6 multicast routes.

The IPv6 Multicast addresses shown can be derived from IPv6 unicast prefixes as per RFC 3306. The IPv6 unicast prefix reserved for documentation is 2001:0db8::/32 as per RFC 3849. Using the base /32 prefix the IPv6 multicast prefix for 2001:0db8::/32 is ff3x:20:2001:0db8::/64. Where an RP address is 2001:0db8::1 the embedded RP multicast prefix is ff7x:120:2001:0db8::/96.

The IPv6 addresses shown use the address space 2001:0db8::/32, defined in RFC 3849 for documentation purposes. These addresses should not be used for practical networks (other than for testing purposes) nor should they appear on any public network.

- Command List**
- “clear ip mroute” on page 1868
 - “clear ip mroute statistics” on page 1869
 - “clear ipv6 mroute” on page 1870
 - “clear ipv6 mroute statistics” on page 1871
 - “debug nsm” on page 1872
 - “debug nsm mcast” on page 1873
 - “debug nsm mcast6” on page 1874
 - “ip mroute” on page 1875
 - “ip multicast handle-igmp-immediately” on page 1877
 - “ip multicast route” on page 1878
 - “ip multicast route-limit” on page 1880
 - “ip multicast wrong-vif-suppression” on page 1881
 - “ip multicast-routing” on page 1882
 - “ipv6 mroute” on page 1883
 - “ipv6 multicast route” on page 1885
 - “ipv6 multicast route-limit” on page 1888
 - “ipv6 multicast-routing” on page 1889
 - “multicast” on page 1890
 - “platform multicast-ratelimit” on page 1891
 - “show debugging nsm mcast” on page 1892
 - “show ip mroute” on page 1893
 - “show ip mvif” on page 1896
 - “show ip rpf” on page 1897
 - “show ipv6 mif” on page 1898
 - “show ipv6 mroute” on page 1899
 - “show ipv6 multicast forwarding” on page 1901

clear ip mroute

Overview Use this command to delete entries from the IPv4 multicast routing table.

NOTE: If you use this command, you should also use the [clear ip igmp group](#) command to clear IGMP group membership records.

Syntax `clear ip mroute {*|<ipv4-group-address>
<ipv4-source-address>} [pim sparse-mode]`

Parameter	Description
*	Deletes all multicast routes.
<ipv4-group-address>	Group IPv4 address, in dotted decimal notation in the format A.B.C.D.
<ipv4-source-address>	Source IPv4 address, in dotted decimal notation in the format A.B.C.D.
pim sparse-mode	Clear specified IPv4 multicast route(s) for PIM Sparse Mode only.

Mode Privileged Exec

Usage notes When this command is used, the Multicast Routing Information Base (MRIB) clears the IPv4 multicast route entries in its IPv4 multicast route table, and removes the entries from the multicast forwarder. The MRIB sends a "clear" message to the multicast protocols. Each multicast protocol has its own "clear" multicast route command. The protocol-specific "clear" command clears multicast routes from PIM Sparse Mode, and also clears the routes from the MRIB.

Examples `awplus# clear ip mroute 225.1.1.1 192.168.3.3`
`awplus# clear ip mroute *`

Related commands [ip multicast route](#)
[show ip mroute](#)

Command changes Version 5.4.7-1.1: VRF-lite support added SBx8100.
Version 5.4.8-1.1: VRF-lite support added x930, SBx908 GEN2.

clear ip mroute statistics

Overview Use this command to delete multicast route statistics entries from the IP multicast routing table.

Syntax `clear ip mroute statistics {*|<ipv4-group-addr>
[<ipv4-source-addr>]}`

Parameter	Description
*	All multicast route entries.
<ipv4-group-addr>	Group IPv4 address, in dotted decimal notation in the format A.B.C.D.
<ipv4-source-addr>	Source IPv4 address, in dotted decimal notation in the format A.B.C.D.

Mode Privileged Exec

Example `awplus# clear ip mroute statistics 225.1.1.2 192.168.4.4`
`awplus# clear ip mroute statistics *`

clear ipv6 mroute

Overview Use this command to delete one or more dynamically-added route entries from the IPv6 multicast routing table.

You need to do this, for example, if you want to create a static route instead of an existing dynamic route.

Syntax `clear ipv6 mroute {*|<ipv6-group-address>
[<ipv6-source-address>]}`

Parameter	Description
*	Deletes all dynamically-learned IPv6 multicast routes.
<ipv6-group-address>	Group IPv6 address, in hexadecimal notation in the format X.X::X.X.
<ipv6-source-address>	Source IPv6 address, in hexadecimal notation in the format X.X::X.X.

Mode Privileged Exec

Usage notes When this command is used, the Multicast Routing Information Base (MRIB) clears the relevant IPv6 multicast route entries in its IPv6 multicast route table, and removes the entries from the multicast forwarder. The MRIB sends a “clear” message to the multicast protocols. Each multicast protocol has its own “clear” multicast route command.

This command does not remove static routes from the routing table or the configuration. To remove static routes, use the **no** parameter of the command [ipv6 multicast route](#).

Example `awplus# clear ipv6 mroute 2001::2 ff08::1`

Related commands [ipv6 multicast route](#)
[show ipv6 mroute](#)

clear ipv6 mroute statistics

Overview Use this command to delete multicast route statistics entries from the IPv6 multicast routing table.

NOTE: *Static IPv6 multicast routes take priority over dynamic IPv6 multicast routes. Use the `clear ipv6 mroute` command to clear static IPv6 multicast routes and ensure dynamic IPv6 multicast routes can take over from previous static IPv6 multicast routes.*

Syntax `clear ipv6 mroute statistics {*|<ipv6-group-address> [<ipv6-source-address>]}`

Parameter	Description
*	All multicast route entries.
<ipv6-group-addr>	Group IPv6 address, in hexadecimal notation in the format X.X::X.X.
<ipv6-source-addr>	Source IPv6 address, in hexadecimal notation in the format X.X::X.X.

Mode Privileged Exec

Examples `awplus# clear ipv6 mroute statistics 2001::2 ff08::1`
`awplus# clear ipv6 mroute statistics *`

debug nsm

Overview This command specifies a set of debug options for use by Allied Telesis authorized service personnel only.

Use the **no** variant of this command to remove debug options.

Syntax `debug nsm [all|events|ha|kernel]`
`no debug nsm [all|events|ha|kernel]`

Parameter	Description
all	Enables all the nsm debugging options
events	Enables the nsm events debugging options
ha	Enables the nsm high availability debugging options
kernel	Enables the nsm kernel debugging options

Mode Global Configuration, Privileged Exec

Usage notes This command is intended for use by Allied Telesis authorized service personnel for diagnostic purposes.

Related commands [show debugging nsm mcast](#)

Command changes Version 5.4.7-2.1 command added.

debug nsm mcast

Overview Use this command to debug IPv4 events in the Multicast Routing Information Base (MRIB).

This command is intended for use by Allied Telesis authorized service personnel for diagnostic purposes.

Syntax `debug nsm mcast`
{all|fib-msg|mrt|mtrace|mtrace-detail|register|stats|vif}

Parameter	Description
all	All IPv4 multicast debugging.
fib-msg	Forwarding Information Base (FIB) messages.
mrt	Multicast routes.
mtrace	Multicast traceroute.
mtrace-detail	Multicast traceroute detailed debugging.
register	Multicast PIM register messages.
stats	Multicast statistics.
vif	Multicast interface.

Mode Privileged Exec and Global Configuration

Examples To enable debugging of all multicast route events, use the commands:

```
awplus# configure terminal  
awplus(config)# debug nsm mcast all
```

To enable debugging of PIM register entries, use the commands:

```
awplus# configure terminal  
awplus(config)# debug nsm mcast register
```

Command changes Version 5.4.7-1.1: VRF-lite support added SBx8100.

Version 5.4.8-1.1: VRF-lite support added x930, SBx908 GEN2.

debug nsm mcast6

Overview Use this command to debug IPv6 events in the Multicast Routing Information Base (MRIB).

This command is intended for use by Allied Telesis authorized service personnel for diagnostic purposes.

Syntax `debug nsm mcast6 {all|fib-msg|mrt|register|stats|vif}`
`no debug nsm mcast6 {all|fib-msg|mrt|register|stats|vif}`

Parameter	Description
all	All IPv6 multicast route debugging.
fib-msg	Forwarding Information Base (FIB) messages.
mrt	Multicast routes.
register	Multicast PIM register messages.
stats	Multicast statistics.
vif	Multicast interfaces.

Mode Privileged Exec and Global Configuration

Examples To enable debugging of all multicast route events, use the commands:

```
awplus# configure terminal  
awplus(config)# debug nsm mcast6 all
```

To enable debugging of PIM register entries, use the commands:

```
awplus# configure terminal  
awplus(config)# debug nsm mcast6 register
```

ip mroute

Overview Use this command to inform multicast of the RPF (Reverse Path Forwarding) route to a given IPv4 multicast source.

Use the **no** variant of this command to delete a route to an IPv4 multicast source.

Syntax

```
ip mroute <ipv4-source-address/mask-length>  
[bgp|ospf|rip|static] <rpf-address> [<admin-distance>]  
  
no ip mroute <ipv4-source-address/mask-length>  
[bgp|ospf|rip|static]
```

Parameter	Description
<ipv4-source-address/mask-length>	A multicast source IPv4 address and mask length, in dotted decimal notation in the format A.B.C.D/M.
bgp	BGP unicast routing protocol.
ospf	OSPF unicast routing protocol.
rip	RIP unicast routing protocol.
static	Specifies a static route.
<rpf-address>	A.B.C.D The closest known address on the multicast route back to the specified source. This host IPv4 address can be within a directly connected subnet or within a remote subnet. In the case that the address is in a remote subnet, a lookup is done from the unicast route table to find the next hop address on the path to this host.
<admin-distance>	The administrative distance. Use this to determine whether the RPF lookup selects the unicast or multicast route. Lower distances have preference. If the multicast static route has the same distance as the other RPF sources, the multicast static route takes precedence. The default is 0 and the range available is 0-255.

Mode Global Configuration

Usage notes Typically, when a Layer 3 multicast routing protocol is determining the RPF (Reverse Path Forwarding) interface for the path to an IPv4 multicast source, it uses the unicast route table to find the best path to the source. However, in some networks a deliberate choice is made to send multicast via different paths to those used for unicast. In this case, the interface via which a multicast stream from a given source enters a router may not be the same as the interface that connects to the best unicast route to that source.

This command enables the user to statically configure the device with "multicast routes" back to given sources. When performing the RPF check on a stream from a given IPv4 source, the multicast routing protocol will look at these static entries as well as looking into the unicast routing table. The route with the lowest

administrative distance - whether a static “multicast route” or a route from the unicast route table - will be chosen as the RPF route to the source.

Note that in this context the term “multicast route” does not imply a route via which the current router will forward multicast; instead it refers to the route the multicast will have traversed in order to arrive at the current router.

Examples The following example creates a static multicast IPv4 route back to the sources in the 10.10.3.0/24 subnet. The multicast route is via the host 192.168.2.3, and has an administrative distance of 2:

```
awplus# configure terminal
awplus(config)# ip mroute 10.10.3.0/24 static 2 192.168.2.3 2
```

The following example creates a static multicast IPv4 route back to the sources in the 192.168.3.0/24 subnet. The multicast route is via the host 10.10.10.50. The administrative distance on this route has the default value of 0:

```
awplus# configure terminal
awplus(config)# ip mroute 192.168.3.0/24 10.10.10.50
```

**Validation
Commands** `show ip rpf`

ip multicast handle-igmp-immediately

Overview Use this command to allow traffic to be switched as soon as an IGMP report is received.

Use the **no** variant of this command to revert to the default setting.

Syntax `ip multicast handle-igmp-immediately`
`no ip multicast handle-igmp-immediately`

Default Turned off. This means that traffic will be switched after either a 1 second delay or if the IGMP buffer fills with 250 packets.

Mode Global Configuration

Example To turn on this feature, use the commands:

```
awplus# configure terminal
awplus(config)# ip multicast handle-igmp-immediately
```

Related commands [show running-config](#)

Command changes Supported since software version 5.4.9-2.0

ip multicast route

Overview Use this command to add an IPv4 static multicast route for a specific multicast source and group IPv4 address to the multicast Routing Information Base (RIB). This IPv4 multicast route is used to forward multicast traffic from a specific source and group ingressing on an upstream interface to a single or range of downstream interfaces.

Use the **no** variant of this command to either remove an IPv4 static multicast route set with this command or to remove a specific downstream interface from an IPv4 static multicast route for a specific multicast source and group IPv4 address.

Syntax

```
ip multicast route <ipv4-source-addr> <ipv4-group-addr>
<upstream-interface> [<downstream-interface>]

no ip multicast route <ipv4-source-addr> <ipv4-group-addr>
[<upstream-interface> <downstream-interface>]
```

Parameter	Description
<ipv4-source-addr>	Source IPv4 address, in dotted decimal notation in the format A.B.C.D.
<ipv4-group-addr>	Group IPv4 address, in dotted decimal notation in the format A.B.C.D.
<upstream-interface>	Upstream interface on which the multicast packets ingress.
<downstream-interface>	Downstream interface or range of interfaces to which the multicast packets are sent.

Default By default, this feature is disabled.

Mode Global Configuration

Usage notes Only one multicast route entry per IPv4 address and multicast group can be specified. Therefore, if one entry for a static multicast route is configured, PIM will not be able to update this multicast route in any way.

If a dynamic multicast route exists you cannot create a static multicast route with the same source IPv4 address, group IPv4 address, upstream interface and downstream interfaces. An error message is displayed and logged. To add a new static multicast route, either wait for the dynamic multicast route to timeout or clear the dynamic multicast route with the [clear ip mroute](#) command.

To update an existing static multicast route entry with more or a new set of downstream interfaces, you must first remove the existing static multicast route and then add the new static multicast route with all downstream interfaces specified. If you attempt to update an existing static multicast route entry with an additional interface or interfaces, an error message is displayed and logged.

To create a blackhole or null route where packets from a specified source and group address coming from an upstream interface are dropped rather than

forwarded, do not specify the optional *<downstream-interface>* parameter when entering this command.

To remove a specific downstream interface from an existing static multicast route entry, specify the interface you want to remove with the *<downstream-interface>* parameter when entering the **no** variant of this command.

Examples To create a static multicast route for the multicast source IPv4 address 2.2.2.2 and group IPv4 address 224.9.10.11, specifying the upstream VLAN interface as vlan10 and the downstream VLAN interface as vlan20, use the following commands:

```
awplus# configure terminal
awplus(config)# ip multicast route 2.2.2.2 224.9.10.11 vlan10
vlan20
```

To create a blackhole route for the multicast source IPv4 address 2.2.2.2 and group IPv4 address 224.9.10.11, specifying the upstream VLAN interface as vlan10, use the following commands:

```
awplus# configure terminal
awplus(config)# ip multicast route 2.2.2.2 224.9.10.11 vlan10
```

To create an IPv4 static multicast route for the multicast source IPv4 address 2.2.2.2 and group IP address 224.9.10.11, specifying the upstream VLAN interface as vlan10 and the downstream VLAN range as vlan20-25, use the following commands:

```
awplus# configure terminal
awplus(config)# ip multicast route 2.2.2.2 224.9.10.11 vlan10
vlan20-25
```

To remove the downstream VLAN 23 from the IPv4 static multicast route created with the above command, use the following commands:

```
awplus# configure terminal
awplus(config)# no ip multicast route 2.2.2.2 224.9.10.11
vlan10 vlan23
```

To delete an IPv4 static multicast route for the multicast source IP address 2.2.2.2 and group IP address 224.9.10.11, use the following commands:

```
awplus# configure terminal
awplus(config)# no ip multicast route 2.2.2.2 224.9.10.11
```

Related commands

- [clear ip mroute](#)
- [show ip mroute](#)

ip multicast route-limit

Overview Use this command to limit the number of multicast routes that can be added to an IPv4 multicast routing table.

Use the **no** variant of this command to return the IPv4 route limit to the default.

Syntax `ip multicast route-limit <limit> [<threshold>]`
`no ip multicast route-limit`

Parameter	Description
<code><limit></code>	<code><1-2147483647></code> Number of routes.
<code><threshold></code>	<code><1-2147483647></code> Threshold above which to generate a warning message. The mroute warning threshold must not exceed the mroute limit.

Default The default limit and threshold value is 2147483647.

Mode Global Configuration

Usage notes This command limits the number of multicast IPv4 routes (mroutes) that can be added to a router, and generates an error message when the limit is exceeded. If the threshold parameter is set, a threshold warning message is generated when this threshold is exceeded, and the message continues to occur until the number of mroutes reaches the limit set by the limit argument.

Examples

```
awplus# configure terminal
awplus(config)# ip multicast route-limit 34 24
awplus# configure terminal
awplus(config)# no ip multicast route-limit
```

Command changes Version 5.4.7-1.1: VRF-lite support added SBx8100.
Version 5.4.8-1.1: VRF-lite support added x930, SBx908 GEN2.

ip multicast wrong-vif-suppression

Overview Use this command to prevent unwanted multicast packets received on an unexpected interface being trapped to the CPU.

Use the no variant of this command to disable wrong VIF suppression.

Syntax `ip ip multicast wrong-vif-suppression`
`no ip multicast wrong-vif-suppression`

Default By default, this feature is disabled.

Mode Global Configuration

Usage notes Use this command if there is excessive CPU load and multicast traffic is enabled. To confirm that VIF messages are being sent to the CPU use the `debug nsm mcast6` command.

Examples To enable the suppression of wrong VIF packets, use the following commands:

```
awplus# configure terminal
awplus(config)# ip multicast wrong-vif-suppression
```

To disable the suppression of wrong VIF packets, use the following commands:

```
awplus# configure terminal
awplus(config)# no ip multicast wrong-vif-suppression
```

ip multicast-routing

Overview Use this command to turn on/off IPv4 multicast routing on the router; when turned off the device does not perform multicast functions.

Use the **no** variant of this command to disable IPv4 multicast routing after enabling it. Note the default stated below.

Syntax `ip multicast-routing`
`no ip multicast-routing`

Default By default, IPv4 multicast routing is off.

Mode Global Configuration

Usage notes When the **no** variant of this command is used, the Multicast Routing Information Base (MRIB) cleans up Multicast Routing Tables (MRT), stops IGMP operation, and stops relaying multicast forwarder events to multicast protocols.

When multicast routing is enabled, the MRIB starts processing any MRT addition/deletion requests, and any multicast forwarding events.

You must enable multicast routing before issuing other multicast commands.

Example `awplus# configure terminal`
`awplus(config)# ip multicast-routing`

Validation Commands `show running-config`

Command changes Version 5.4.7-1.1: VRF-lite support added SBx8100.
Version 5.4.8-1.1: VRF-lite support added x930, SBx908 GEN2.

ipv6 mroute

Overview Use this command to inform multicast of the RPF (Reverse Path Forwarding) route to a given IPv6 multicast source.

Use the **no** variant of this command to delete a route to an IPv6 multicast source.

Syntax `ipv6 mroute <ipv6-source-address/mask-length> [rip|static] <rpf-address> [<admin-distance>]`

`no ipv6 mroute <ipv6-source-address/mask-length> [rip|static]`

Parameter	Description
<code><ipv6-source-address/mask-length></code>	A multicast source IPv6 address and mask length, in hexadecimal notation in the format X.X::X.X/M.
<code>rip</code>	RIPng IPv6 unicast routing protocol.
<code>static</code>	Specifies a static route.
<code><rpf-address></code>	X.X::X:X The closest known address on the IPv6 multicast route back to the specified source. This host IPv6 address can be within a directly connected subnet or within a remote subnet. In the case that the address is in a remote subnet, a lookup is done from the unicast route table to find the nexthop address on the path to this host.
<code><admin-distance></code>	The administrative distance. Use this to determine whether the RPF lookup selects the unicast or multicast route. Lower distances have preference. If the multicast static route has the same distance as the other RPF sources, the multicast static route takes precedence. The default is 0 and the range available is 0-255.

Mode Global Configuration

Usage notes Typically, when a Layer 3 multicast routing protocol is determining the RPF (Reverse Path Forwarding) interface for the path to a multicast source, it uses the unicast IPv6 route table to find the best path to the source. However, in some networks a deliberate choice is made to send multicast via different paths to those used for unicast. In this case, the interface via which a multicast stream from a given source enters a router may not be the same as the interface that connects to the best unicast route to that source.

This command enables the user to statically configure the switch with “multicast routes” back to given sources. When performing the RPF check on a stream from a given IPv6 source, the multicast routing protocol will look at these static entries as well as looking into the unicast routing table. The route with the lowest administrative distance - whether a static “multicast route” or a route from the unicast route table - will be chosen as the RPF route to the source.

Note that in this context the term “multicast route” does not imply a route via which the current router will forward multicast; instead it refers to the route the multicast will have traversed in order to arrive at the current router.

Examples The following example creates a static multicast route back to the sources in the 2001::1/64 subnet. The multicast route is via the host 2002::2, and has an administrative distance of 2:

```
awplus# configure terminal
awplus(config)# ipv6 mroute 2001::1/64 static 2 2002::2
```

The following example creates a static multicast route back to the sources in the 2002::2/64 subnet. The multicast route is via the host 2001::1. The administrative distance on this route has the default value of 0:

```
awplus# configure terminal
awplus(config)# ipv6 mroute 2002::2/64 2001::1
```

**Validation
Commands** `show ipv6 mroute`

ipv6 multicast route

Overview Use this command to add an IPv6 static multicast route for a specific multicast source and group IPv6 address to the multicast Routing Information Base (RIB). This IPv6 multicast route is used to forward IPv6 multicast traffic from a specific source and group ingressing on an upstream interface to a single or range of downstream interfaces.

See detailed usage notes below to configure static multicast router ports when using static IPv6 multicast routes with EPSR, and the destination VLAN is an EPSR data VLAN.

Use the **no** variant of this command to either remove an IPv6 static multicast route set with this command or to remove a specific downstream interface from an IPv6 static multicast route for a specific IPv6 multicast source and group address.

Syntax `ipv6 multicast route <ipv6-source-addr> <ipv6-group-addr>
<upstream-interface> [<downstream-interface>]`
`no ipv6 multicast route <ipv6-source-addr> <ipv6-group-addr>
[<upstream-interface> <downstream-interface>]`

Parameter	Description
<code><ipv6-source-addr></code>	Source IPv6 address, in dotted decimal notation in the format X.X::X.X.
<code><ipv6-group-addr></code>	Group IP address, in dotted decimal notation in the format X.X::X.X.
<code><upstream-interface></code>	Upstream interface on which the multicast packets ingress.
<code><downstream-interface></code>	Downstream interface or range of interfaces to which the multicast packets are sent.

Default By default, no static routes exist.

Mode Global Configuration

Usage notes Only one multicast route entry per IPv6 address and multicast group can be specified. Therefore, if one entry for an IPv6 static multicast route is configured, PIM will not be able to update this multicast route in any way.

If a dynamic multicast route exists, you cannot create a static multicast route with the same source IPv6 address and group IPv6 address. An error message is displayed and logged. To add a new static multicast route, either wait for the dynamic multicast route to time out or clear the dynamic multicast route with the [clear ipv6 mroute](#) command.

To update an existing IPv6 static multicast route entry with new or additional downstream interfaces, you must first remove the existing static multicast route and then add the new static multicast route with all downstream interfaces

specified. If you attempt to update an existing static multicast route entry with an additional interface or interfaces an error message is displayed and logged.

To remove a specific downstream interface from an existing static multicast route entry, specify the interface you want to remove with the *<downstream-interface>* parameter when entering the **no** variant of this command.

Note that if static IPv6 multicast routing is being used with EPSR and the destination VLAN is an EPSR data VLAN, then multicast router (mrouter) ports must be statically configured. This minimizes disruption for multicast traffic in the event of ring failure or restoration.

When configuring the EPSR data VLAN, statically configure mrouter ports so that the multicast router can be reached in either direction around the EPSR ring.

For example, if port1.0.1 and port1.0.8 are ports on an EPSR data VLAN vlan101, which is the destination for a static IPv6 multicast route, then configure both ports as multicast router (mrouter) ports as shown in the example commands listed below:

```
awplus>enable
awplus#configure terminal
awplus(config)#interface vlan101
awplus(config-if)#ipv6 mld snooping mrouter interface port1.0.1
awplus(config-if)#ipv6 mld snooping mrouter interface port1.0.8
```

See [ipv6 mld snooping mrouter](#) for a command description and command examples.

Examples To create an IPv6 static multicast route for the multicast source IPv6 address 2001::1 and group IPv6 address ff08::1, specifying the upstream VLAN interface as vlan10 and the downstream VLAN interface as vlan20, use the following commands:

```
awplus# configure terminal
awplus(config)# ipv6 multicast route 2001::1 ff08::1 vlan10
vlan20
```

To create a blackhole route for the IPv6 multicast source IP address 2001::1 and group IP address ff08::1, specifying the upstream VLAN interface as vlan10, use the following commands:

```
awplus# configure terminal
awplus(config)# ipv6 multicast route 2001::1 ff08::1 vlan10
```

To create an IPv6 static multicast route for the multicast source IPv6 address 2001::1 and group IPv6 address ff08::1, specifying the upstream VLAN interface as

vlan10 and the downstream VLAN range as vlan20-25, use the following commands:

```
awplus# configure terminal
awplus(config)# ipv6 multicast route 2001::1 ff08::1 vlan10
vlan20-25
```

To remove the downstream VLAN 23 from the IPv6 static multicast route created with the above command, use the following commands:

```
awplus# configure terminal
awplus(config)# no ipv6 multicast route 2001::1 ff08::1 vlan10
vlan23
```

To delete an IPv6 static multicast route for the multicast source IPv6 address 2001::1 and group IPv6 address ff08::1, use the following commands:

```
awplus# configure terminal
awplus(config)# no ipv6 multicast route 2001::1 ff08::1
```

Related commands

- [clear ipv6 mroute](#)
- [ipv6 mld snooping mrouter](#)
- [show ipv6 mroute](#)

ipv6 multicast route-limit

Overview Use this command to limit the number of multicast routes that can be added to an IPv6 multicast routing table.

Use the no variant of this command to return the IPv6 route limit to the default.

Syntax `ipv6 multicast route-limit <limit> [<threshold>]`
`no ipv6 multicast route-limit`

Parameter	Description
<code><limit></code>	<code><1-2147483647></code> Number of routes.
<code><threshold></code>	<code><1-2147483647></code> Threshold above which to generate a warning message. The mroute warning threshold must not exceed the mroute limit.

Default The default limit and threshold value is 2147483647.

Mode Global Configuration

Usage notes This command limits the number of multicast IPv6 routes (mroutes) that can be added to a router, and generates an error message when the limit is exceeded. If the threshold parameter is set, a threshold warning message is generated when this threshold is exceeded, and the message continues to occur until the number of mroutes reaches the limit set by the limit argument.

Examples

```
awplus# configure terminal
awplus(config)# ipv6 multicast route-limit 34 24
awplus# configure terminal
awplus(config)# no ipv6 multicast route-limit
```

ipv6 multicast-routing

Overview Use this command to turn on/off IPv6 multicast routing on the router; when turned off the device does not perform multicast functions.

Use the **no** variant of this command to disable IPv6 multicast routing after enabling it. Note the default stated below.

Syntax `ipv6 multicast-routing`
`no ipv6 multicast-routing`

Default By default, IPv6 multicast routing is off.

Mode Global Configuration

Usage When the **no** variant of this command is used, the Multicast Routing Information Base (MRIB) cleans up Multicast Routing Tables (MRT), and stops relaying multicast forwarder events to multicast protocols.

When multicast routing is enabled, the MRIB starts processing any MRT addition/deletion requests, and any multicast forwarding events.

You must enable multicast routing before issuing other multicast commands.

Examples `awplus# configure terminal`
`awplus(config)# ipv6 multicast-routing`
`awplus# configure terminal`
`awplus(config)# no ipv6 multicast-routing`

Validation Commands `show running-config`

multicast

Overview Use this command to enable a device port to route multicast packets that ingress the port.

Use the **no** variant of this command to stop the device port from routing multicast packets that ingress the port. Note that this does not affect Layer 2 forwarding of multicast packets. If you enter **no multicast** on a port, multicast packets received on that port will not be forwarded to other VLANs, but ports in the same VLANs as the receiving port will still receive the multicast packets.

CAUTION: *We do not recommend disabling multicast routing in a live network. Some non-multicast protocols use multicast packets and will not function correctly if you disable it.*

Syntax multicast
no multicast

Default By default, all device ports route multicast packets.

Mode Interface Configuration

Examples To disable routing of multicast packets on a port, use the commands:

```
awplus# configure terminal
awplus(config)# interface port1.0.1
awplus(config-if)# no multicast
```

To re-enable routing of multicast packets on a port, use the commands:

```
awplus# configure terminal
awplus(config)# interface port1.0.1
awplus(config-if)# multicast
```

Validation Commands `show running-config`

platform multicast-ratelimit

Overview Use this command to set the maximum number of multicast packets to be forwarded to the CPU (in packets per second). Setting the value to zero disables rate limiting.

This command should be used with care. Increasing or removing the limit could make the device less responsive under heavy multicast load.

Use the **no** variant of this command to return the limit to its default.

Syntax `platform multicast-ratelimit <0-1000>`
`no platform multicast-ratelimit`

Default 10 packets per second (pps)

Mode Global Configuration

Usage notes If you find that the CPU load on your device from multicast traffic is higher than desired, reducing this rate may reduce the CPU load.

If you need the device to process a large amount of multicast traffic, increasing this rate may improve performance.

Example To set the rate to 30pps, use the commands:

```
awplus# configure terminal
awplus(config)# platform multicast-ratelimit 30
```

Command changes Version 5.4.8-1.1: default changed to 100pps on SBx908 GEN2, SBx8100, and x930 Series switches.

show debugging nsm mcast

Overview Use this command to show the status of the NSM multicast debugging.

Syntax show debugging nsm mcast

Parameter	Description
<vrf-name>	VRF instance name

Mode Privileged Exec

Usage notes This command is intended for use by Allied Telesis authorized service personnel for diagnostic purposes.

Example To show debugging for NSM multicast, use the following command:

```
awplus# show debug nsm mcast
```

Output Figure 36-1: Example output from **show debug nsm mcast**

```
awplus# show debugging nsm mcast
Debugging status:
NSM multicast vif debugging is on
NSM multicast route debugging is on
NSM multicast route statistics debugging is on
NSM multicast FIB message debugging is on
NSM multicast PIM Register message debugging is on
NSM multicast traceroute debugging is on
NSM multicast traceroute detailed debugging is on
```

Related commands [debug nsm mcast](#)

Command changes Version 5.4.7-2.1: command added
Version 5.4.8-1.1: VRF-lite support added x930, SBx908 GEN2

show ip mroute

Overview Use this command to display the contents of the IPv4 multicast routing (mroute) table.

Syntax `show ip mroute [<ipv4-group-addr>] [<ipv4-source-addr>]
[dense|sparse] [count|summary]`

Parameter	Description
<ipv4-group-addr>	Group IPv4 address, in dotted decimal notation in the format A.B.C.D.
<ipv4-source-addr>	Source IPv4 address, in dotted decimal notation in the format A.B.C.D.
dense	Display dense IPv4 multicast routes.
sparse	Display sparse IPv4 multicast routes.
count	Display the route and packet count from the IPv4 multicast routing (mroute) table.
summary	Display the contents of the IPv4 multicast routing (mroute) table in an abbreviated form.

Mode User Exec and Privileged Exec

Examples

```
awplus# show ip mroute 10.10.3.34 224.1.4.3
awplus# show ip mroute 10.10.5.24 225.2.2.2 count
awplus# show ip mroute 10.10.1.34 summary
```

Output The following is a sample output of this command displaying the IPv4 multicast routing table, with and without specifying the group and source IPv4 address:

Figure 36-2: Example output from the **show ip mroute** command

```
awplus# show ip mroute
IP Multicast Routing Table
Flags: I - Immediate Stat, T - Timed Stat, F - Forwarder
installed
Timers: Uptime/Stat Expiry
Interface State: Interface (TTL)

(10.10.1.52, 224.0.1.3), uptime 00:00:31, stat expires 00:02:59
Owner PIM-SM, Flags: TF
  Incoming interface: vlan2
  Outgoing interface list:
    vlan3 (1)
```

Figure 36-3: Example output from the **show ip mroute** command with the source and group IPv4 address specified

```
awplus# show ip mroute 10.10.1.52 224.0.1.3

IP Multicast Routing Table
Flags: I - Immediate Stat, T - Timed Stat, F - Forwarder
installed
Timers: Uptime/Stat Expiry
Interface State: Interface (TTL)

(10.10.1.52, 224.0.1.3), uptime 00:03:24, stat expires 00:01:28
Owner PIM-SM, Flags: TF
  Incoming interface: vlan2
  Outgoing interface list:
    vlan3 (1)
```

The following is a sample output of this command displaying the packet count from the IPv4 multicast routing table:

Figure 36-4: Example output from the **show ip mroute count** command

```
awplus# show ip mroute count
IP Multicast Statistics
Total 1 routes using 132 bytes memory
Route limit/Route threshold: 2147483647/2147483647
Total NOCACHE/WROGVIF/WHOLEPKT rcv from fwd: 1/0/0
Total NOCACHE/WROGVIF/WHOLEPKT sent to clients: 1/0/0
Immediate/Timed stat updates sent to clients: 0/0
Reg ACK rcv/Reg NACK rcv/Reg pkt sent: 0/0/0
Next stats poll: 00:01:10

Forwarding Counts: Pkt count/Byte count, Other Counts: Wrong If
pkts
Fwd msg counts: WROGVIF/WHOLEPKT rcv
Client msg counts: WROGVIF/WHOLEPKT/Imm Stat/Timed Stat sent
Reg pkt counts: Reg ACK rcv/Reg NACK rcv/Reg pkt sent

(10.10.1.52, 224.0.1.3), Forwarding: 2/19456, Other: 0
  Fwd msg: 0/0, Client msg: 0/0/0/0, Reg: 0/0/0
```

The following is a sample output for this command displaying the IPv4 multicast routing table in an abbreviated form:

Figure 36-5: Example output from the **show ip mroute summary** command

```
awplus# show ip mroute summary

IP Multicast Routing Table
Flags: I - Immediate Stat, T - Timed Stat, F - Forwarder
installed
Timers: Uptime/Stat Expiry
Interface State: Interface (TTL)

(10.10.1.52, 224.0.1.3), 00:01:32/00:03:20, PIM-SM, Flags: TF
```

- Command changes**
- Version 5.4.7-1.1: VRF-lite support added SBx8100.
 - Version 5.4.8-1.1: VRF-lite support added x930, SBx908 GEN2.

show ip mvif

Overview Use this command to display the contents of the IPv4 Multicast Routing Information Base (MRIB) VIF table.

Syntax `show ip mvif <interface>`

Parameter	Description
<code><interface></code>	The interface to display information about.

Mode User Exec and Privileged Exec

Example `awplus# show ip mvif vlan2`

Output Figure 36-6: Example output from the **show ip mvif** command

Interface	Vif Idx	Owner Module	TTL	Local Address	Remote Address	Uptime
vlan2	0	PIM-SM	1	192.168.1.53	0.0.0.0	00:04:26
Register	1		1	192.168.1.53	0.0.0.0	00:04:26
vlan3	2	PIM-SM	1	192.168.10.53	0.0.0.0	00:04:25

Figure 36-7: Example output from the **show ip mvif** command with the interface parameter specified

Interface	Vif Idx	Owner Module	TTL	Local Address	Remote Address	Uptime
vlan2	0	PIM-SM	1	192.168.1.53	0.0.0.0	00:05:17

Command changes Version 5.4.7-1.1: VRF-lite support added SBx8100.

Version 5.4.8-1.1: VRF-lite support added x930, SBx908 GEN2.

show ip rpf

Overview Use this command to display Reverse Path Forwarding (RPF) information for the specified IPv4 source address.

Syntax `show ip rpf <source-addr>`

Parameter	Description
<code><source-addr></code>	Source IPv4 address, in dotted decimal notation in the format A.B.C.D.

Mode User Exec and Privileged Exec

Example `awplus# show ip rpf 10.10.10.50`

Command changes Version 5.4.7-1.1: VRF-lite support added SBx8100.
Version 5.4.8-1.1: VRF-lite support added x930, SBx908 GEN2.

show ipv6 mif

Overview Use this command to display the contents of the IPv6 Multicast Routing Information Base (MRIB) MIF table.

Syntax `show ipv6 mif [<interface>]`

Parameter	Description
<interface>	The interface to display information about.

Mode User Exec and Privileged Exec

Example
`awplus# show ipv6 mif`
`awplus# show ipv6 mif vlan2`

Output Figure 36-8: Example output from the **show ipv6 mif** command

```
awplus#show ipv6 mif
Interface  Mif  Owner          Uptime
          Idx  Module
vlan3     0    MLD/MLD Proxy-Service 03:28:48
vlan2     1    MLD/MLD Proxy-Service 03:28:48
vlan1     2    MLD/MLD Proxy-Service 03:28:48
```

Figure 36-9: Example output from the **show ipv6 mif** command with the interface parameter specified

Interface	Mif	Owner	TTL	Remote	Uptime
	Idx	Module		Address	
vlan2	0	PIM-SMv6	1	0.0.0.0	00:05:17

show ipv6 mroute

Overview Use this command to display the contents of the IPv6 multicast routing (mroute) table.

Syntax `show ipv6 mroute [<ipv6-group-addr>] [<ipv6-source-addr>] [{count|summary}]`

Parameter	Description
<code><ipv6-group-addr></code>	Group IPv6 address, in hexadecimal notation in the format X.X::X.X.
<code><ipv6-source-addr></code>	Source IPv6 address, in hexadecimal notation in the format X.X::X.X.
<code>count</code>	Display the route and packet count from the IPv6 multicast routing (mroute) table.
<code>summary</code>	Display the contents of the IPv6 multicast routing (mroute) table in an abbreviated form.

Mode User Exec and Privileged Exec

Examples

```
awplus# show ipv6 mroute
awplus# show ipv6 mroute count
awplus# show ipv6 mroute summary
awplus# show ipv6 mroute 2001::2 ff08::1 count
awplus# show ipv6 mroute 2001::2 ff08::1
awplus# show ipv6 mroute 2001::2 summary
```

Output The following is a sample output of this command displaying the IPv6 multicast routing table for a single static IPv6 Multicast route:

Figure 36-10: Example output from the **show ipv6 mroute** command

```
awplus#show ipv6 mroute
IPv6 Multicast Routing Table
Flags: I - Immediate Stat, T - Timed Stat, F - Forwarder
installed
Timers: Uptime/Stat Expiry
Interface State: Interface
(2001::2, ff08::1), uptime 03:18:38
Owner IMI, Flags: F
  Incoming interface: vlan2
  Outgoing interface list:
    vlan3
```

The following is a sample output of this command displaying the IPv6 multicast routing count table for a single static IPv6 Multicast route:

Figure 36-11: Example output from the **show ipv6 mroute count** command

```
awplus#show ipv6 mroute count

IPv6 Multicast Statistics
Total 1 routes using 152 bytes memory
Route limit/Route threshold: 1024/1024
Total NOCACHE/WRONGmif/WHOLEPKT rcv from fwd: 6/0/0
Total NOCACHE/WRONGmif/WHOLEPKT sent to clients: 6/0/0
Immediate/Timed stat updates sent to clients: 0/0
Reg ACK rcv/Reg NACK rcv/Reg pkt sent: 0/0/0
Next stats poll: 00:01:14

Forwarding Counts: Pkt count/Byte count, Other Counts: Wrong If
pkts
Fwd msg counts: WRONGmif/WHOLEPKT rcv
Client msg counts: WRONGmif/WHOLEPKT/Imm Stat/Timed Stat sent
Reg pkt counts: Reg ACK rcv/Reg NACK rcv/Reg pkt sent

(2001::2, ff08::1), Forwarding: 0/0, Other: 0
  Fwd msg: 0/0, Client msg: 0/0/0/0, Reg: 0/0/0
```

The following is a sample output of this command displaying the IPv6 multicast routing summary table for a single static IPv6 Multicast route:

Figure 36-12: Example output from the **show ipv6 mroute summary** command

```
awplus#show ipv6 mroute summary

IPv6 Multicast Routing Table
Flags: I - Immediate Stat, T - Timed Stat, F - Forwarder
installed
Timers: Uptime/Stat Expiry
Interface State: Interface

(2001::2, ff08::1), 03:20:28/-, IMI, Flags: F
```

show ipv6 multicast forwarding

Overview Use this command to view the status of multicast forwarding slow-path-packet setting.

Syntax `show ipv6 multicast forwarding`

Mode User Exec

Example To show the status of the multicast forwarding, slow-path-packet setting, use the following command:

```
awplus# show ipv6 multicast forwarding
```

Output Figure 36-13: Example output from the **show ipv6 multicast forwarding** command:

```
ipv6 multicast forwarding is disabled
```

Related commands [ipv6 multicast forward-slow-path-packet](#)

37

PIM-SM Commands

Introduction

Overview This chapter provides an alphabetical reference of PIM-SM commands. For commands common to PIM-SM and PIM-DM, see the [Multicast Commands](#) chapter.

- Command List**
- “clear ip pim sparse-mode bsr rp-set *” on page 1904
 - “clear ip pim sparse-mode packet statistics” on page 1905
 - “clear ip mroute pim sparse-mode” on page 1906
 - “debug pim sparse-mode” on page 1907
 - “debug pim sparse-mode timer” on page 1908
 - “ip pim anycast-rp” on page 1910
 - “ip pim bsr-border” on page 1911
 - “ip pim bsr-candidate” on page 1912
 - “ip pim cisco-register-checksum” on page 1913
 - “ip pim crp-cisco-prefix” on page 1914
 - “ip pim dr-priority” on page 1915
 - “ip pim exclude-genid” on page 1916
 - “ip pim ext-srcs-directly-connected” on page 1917
 - “ip pim hello-holdtime (PIM-SM)” on page 1918
 - “ip pim hello-interval (PIM-SM)” on page 1919
 - “ip pim ignore-rp-set-priority” on page 1920
 - “ip pim jp-timer” on page 1921
 - “ip pim register-rate-limit” on page 1922
 - “ip pim register-rp-reachability” on page 1923

- [“ip pim register-source”](#) on page 1924
- [“ip pim register-suppression”](#) on page 1925
- [“ip pim rp-address”](#) on page 1926
- [“ip pim rp-candidate”](#) on page 1928
- [“ip pim rp-register-kat”](#) on page 1929
- [“ip pim sparse-mode”](#) on page 1930
- [“ip pim sparse-mode join-prune-batching”](#) on page 1931
- [“ip pim sparse-mode passive”](#) on page 1933
- [“ip pim sparse-mode wrong-vif-suppression”](#) on page 1934
- [“ip pim spt-threshold”](#) on page 1936
- [“ip pim ssm”](#) on page 1937
- [“service pim”](#) on page 1938
- [“show debugging pim sparse-mode”](#) on page 1939
- [“show ip pim sparse-mode bsr-router”](#) on page 1940
- [“show ip pim sparse-mode interface”](#) on page 1941
- [“show ip pim sparse-mode interface detail”](#) on page 1943
- [“show ip pim sparse-mode local-members”](#) on page 1944
- [“show ip pim sparse-mode mroute”](#) on page 1945
- [“show ip pim sparse-mode mroute detail”](#) on page 1947
- [“show ip pim sparse-mode neighbor”](#) on page 1949
- [“show ip pim sparse-mode nexthop”](#) on page 1951
- [“show ip pim sparse-mode packet statistics”](#) on page 1952
- [“show ip pim sparse-mode rp-hash”](#) on page 1953
- [“show ip pim sparse-mode rp mapping”](#) on page 1954
- [“undebug all pim sparse-mode”](#) on page 1955

clear ip pim sparse-mode bsr rp-set *

Overview Use this command to clear all Rendezvous Point (RP) sets learned through the PIMv2 Bootstrap Router (BSR).

Syntax `clear ip pim sparse-mode bsr rp-set *`

Parameter	Description
*	Clears all RP sets.

Mode Privileged Exec

Usage notes For multicast clients, note that one router will be automatically or statically designated as the RP, and all routers must explicitly join through the RP. A Designated Router (DR) sends periodic Join/Prune messages toward a group-specific RP for each group that it has active members.

For multicast sources, note that the Designated Router (DR) unicasts Register messages to the RP encapsulating the data packets from the multicast source. The RP forwards decapsulated data packets toward group members.

Example `awplus# clear ip pim sparse-mode bsr rp-set *`

Command changes Version 5.4.7-1.1: VRF-lite support added SBx8100.

Version 5.4.8-1.1: VRF-lite support added x930, SBx908 GEN2.

clear ip pim sparse-mode packet statistics

Overview Use this command to clear the PIM sparse mode packet statistics counter.

Syntax `clear ip pim sparse-mode packet statistics`

Mode Privileged Exec

Example The following command clears the current packet receive counts for PIM sparse-mode:

```
awplus# configure terminal
awplus(config)# clear ip pim sparse-mode statistics
```

Output Figure 37-1: Example output from **clear ip pim sparse-mode statistics**

```
awplus(config)#clear ip pim sparse-mode statistics
PIM-SM Receive Packet Statistics :
All PIM-SM      : Total : 0 Valid : 0
Hello          : Total : 0 Valid : 0
Register       : Total : 0 Valid : 0
Register Stop  : Total : 0 Valid : 0
Join/Prune     : Total : 0 Valid : 0
Bootstrap     : Total : 0 Valid : 0
Assert        : Total : 0 Valid : 0
Candidate-RP   : Total : 0 Valid : 0
```

Related commands [show ip pim sparse-mode packet statistics](#)

Command changes Version 5.4.7-1.1: VRF-lite support added SBx8100.
Version 5.4.8-1.1: VRF-lite support added x930, SBx908 GEN2.

clear ip mroute pim sparse-mode

Overview Use this command to clear all multicast route table entries learned through PIM-SM for a specified multicast group address, and optionally a specified multicast source address.

Syntax `clear ip mroute <Group-IP-address> pim sparse-mode`
`clear ip mroute <Group-IP-address> <Source-IP-address> pim sparse-mode`

Parameter	Description
<code><Group-IP-address></code>	Specify a multicast group IPv6 address, entered in the form A.B.C.D.
<code><Source-IP-address></code>	Specify a source group IP address, entered in the form A.B.C.D.

Mode Privileged Exec

Example `awplus# clear ip mroute pim sparse-mode 224.0.0.0`
`awplus# clear ip mroute 192.168.7.1 pim sparse-mode 224.0.0.0`

Command changes Version 5.4.7-1.1: VRF-lite support added SBx8100.
Version 5.4.8-1.1: VRF-lite support added x930, SBx908 GEN2.

debug pim sparse-mode

Overview Use this command to turn on some or all PIM-SM debugging.

Use the **no** variant of this command to turn off some or all PIM-SM debugging.

Syntax `debug pim sparse-mode [all] [events] [mfc] [mib] [nexthop] [nsm] [packet] [state] [mtrace]`

`no debug pim sparse-mode [all] [events] [mfc] [mib] [nexthop] [nsm] [packet] [state] [mtrace]`

Parameter	Description
all	Activates/deactivates all PIM-SM debugging.
events	Activates debug printing of events.
mfc	Activates debug printing of MFC (Multicast Forwarding Cache in kernel) add/delete/updates.
mib	Activates debug printing of PIM-SM MIBs.
nexthop	Activates debug printing of PIM-SM next hop communications.
nsm	Activates debugging of PIM-SM Network Services Module communications.
packet	Activates debug printing of incoming and/or outgoing packets.
state	Activates debug printing of state transition on all PIM-SM FSMs.
mtrace	Activates debug printing of multicast traceroute.

Mode Privileged Exec and Global Configuration

Example
`awplus# configure terminal`
`awplus(config)# debug pim sparse-mode all`

Related commands [show debugging pim sparse-mode](#)

Command changes
Version 5.4.7-1.1: VRF-lite support added SBx8100.
Version 5.4.8-1.1: VRF-lite support added x930, SBx908 GEN2.

debug pim sparse-mode timer

Overview Use this command to enable debugging for the specified PIM-SM timers. Use the **no** variants of this command to disable debugging for the specified PIM-SM timers.

Syntax

```
debug pim sparse-mode timer assert [at]
no debug pim sparse-mode timer assert [at]
debug pim sparse-mode timer bsr [bst|crp]
no debug pim sparse-mode timer bsr [bst|crp]
debug pim sparse-mode timer hello [ht|nlt|tht]
no debug pim sparse-mode timer hello [ht|nlt|tht]
debug pim sparse-mode timer joinprune [jt|et|ppt|kat|ot]
no debug pim sparse-mode timer joinprune [jt|et|ppt|kat|ot]
debug pim sparse-mode timer register [rst]
no debug pim sparse-mode timer register [rst]
```

Parameter	Description
assert	Enable or disable debugging for the Assert timers.
at	Enable or disable debugging for the Assert Timer.
bsr	Enable or disable debugging for the specified Bootstrap Router timer, or all Bootstrap Router timers.
bst	Enable or disable debugging for the Bootstrap Router: Bootstrap Timer.
crp	Enable or disable debugging for the Bootstrap Router: Candidate-RP Timer.
hello	Enable or disable debugging for the specified Hello timer, or all Hello timers.
ht	Enable or disable debugging for the Hello timer: Hello Timer.
nlt	Enable or disable debugging for the Hello timer: Neighbor Liveness Timer.
tht	Enable or disable debugging for the Hello timer: Triggered Hello Timer.
joinprune	Enable or disable debugging for the specified JoinPrune timer, or all JoinPrune timers.
jt	Enable or disable debugging for the JoinPrune timer: upstream Join Timer.
et	Enable or disable debugging for the JoinPrune timer: Expiry Timer.
ppt	Enable or disable debugging for the JoinPrune timer: PrunePending Timer.

Parameter	Description
kat	Enable or disable debugging for the JoinPrune timer: KeepAlive Timer.
ot	Enable or disable debugging for the JoinPrune timer: Upstream Override Timer.
register	Enable or disable debugging for the Register timers.
rst	Enable or disable debugging for the Register timer: Register Stop Timer.

Default By default, all debugging is disabled.

Mode Privileged Exec and Global Configuration

Examples To enable debugging for the PIM-SM Bootstrap Router bootstrap timer, use the commands:

```
awplus(config)# debug pim sparse-mode timer bsr bst
```

To enable debugging for the PIM-SM Hello: neighbor liveness timer, use the command:

```
awplus(config)# debug pim sparse-mode timer hello ht
```

To enable debugging for the PIM-SM Joinprune expiry timer, use the command:

```
awplus# debug pim sparse-mode timer joinprune et
```

To disable debugging for the PIM-SM Register timer, use the command:

```
awplus# no debug pim sparse-mode timer register
```

Related commands [show debugging pim sparse-mode](#)

Command changes Version 5.4.7-1.1: VRF-lite support added SBx8100.

Version 5.4.8-1.1: VRF-lite support added x930, SBx908 GEN2.

ip pim anycast-rp

Overview Use this command to configure Anycast RP (Rendezvous Point) in a RP set.
Use the **no** variant of this command to remove the configuration.

Syntax `ip pim anycast-rp <anycast-rp-address> <member-rp-address>`
`no ip pim anycast-rp <anycast-rp-address> [<member-rp-address>]`

Parameter	Description
<code><anycast-rp-address></code>	<A.B.C.D> Specify an anycast IP address to configure an Anycast RP (Rendezvous Point) in a RP set.
<code><member-rp-address></code>	<A.B.C.D> Specify an Anycast RP (Rendezvous Point) address to configure an Anycast RP in a RP set.

Mode Global Configuration

Usage notes Anycast is a network addressing and routing scheme where data is routed to the nearest or best destination as viewed by the routing topology. Compared to unicast with a one-to-one association between network address and network endpoint, and multicast with a one-to-many association between network address and network endpoint; anycast has a one-to-many association between network address and network endpoint. For anycast, each destination address identifies a set of receiver endpoints, from which only one receiver endpoint is chosen.

Anycast is often implemented using BGP to simultaneously advertise the same destination IP address range from many sources, resulting in packets address to destination addresses in this range being routed to the nearest source announcing the given destination IP address.

Use this command to specify the Anycast RP configuration in the Anycast RP set. Use the **no** variant of this command to remove the Anycast RP configuration. Note that the member RP address is optional when using the **no** parameter to remove the Anycast RP configuration. removing the anycast RP address also removes the member RP address.

Examples The following example shows how to configure the Anycast RP address with **ip pim anycast-rp**:

```
awplus# configure terminal
awplus(config)# ip pim anycast-rp 1.1.1.1 10.10.10.10
```

The following example shows how to remove the Anycast RP in the RP set specifying only the anycast RP address with **no ip pim anycast-rp**, but not specifying the member RP address:

```
awplus# configure terminal
awplus(config)# no ip pim anycast-rp 1.1.1.1
```

ip pim bsr-border

Overview Use the **ip pim bsr-border** command to prevent Bootstrap Router (BSR) messages from being sent or received through an interface. The BSR border is the border of the PIM domain.

Use the **no** variant of this command to disable the configuration set with **ip pim bsr-border**.

Syntax `ip pim bsr-border`
`no ip pim bsr-border`

Mode Interface Configuration for a VLAN, Eth or PPP interface.

Usage notes When this command is configured on an interface, no PIM version 2 BSR messages will be sent or received through the interface. Configure an interface bordering another PIM domain with this command to avoid BSR messages from being exchanged between the two PIM domains.

BSR messages should not be exchanged between different domains, because devices in one domain may elect Rendezvous Points (RPs) in the other domain, resulting in loss of isolation between the two PIM domains that would stop the PIM protocol from working as intended.

Examples The following example configures the VLAN interface `vlan2` to be the PIM domain border:

```
awplus# configure terminal
awplus(config)# interface vlan2
awplus(config-if)# ip pim bsr-border
```

The following example removes the VLAN interface `vlan2` from the PIM domain border:

```
awplus# configure terminal
awplus(config)# interface vlan2
awplus(config-if)# no ip pim bsr-border
```

The following example configures the PPP interface `ppp0` to be the PIM domain border:

```
awplus# configure terminal
awplus(config)# interface ppp0
awplus(config-if)# ip pim bsr-border
```

The following example removes the PPP interface `ppp0` from the PIM domain border:

```
awplus# configure terminal
awplus(config)# interface ppp0
awplus(config-if)# no ip pim bsr-border
```

ip pim bsr-candidate

Overview Use this command to give the device the candidate BSR (Bootstrap Router) status using the specified IP address mask of the interface.

Use the **no** variant of this command to withdraw the address of the interface from being offered as a BSR candidate.

Syntax `ip pim bsr-candidate <interface> [<hash>] [<priority>]`
`no ip pim bsr-candidate [<interface>]`

Parameter	Description
<interface>	The interface.
<hash>	<0-32> configure hash mask length for RP selection. The default hash value if you do not configure this parameter is 10.
<priority>	<0-255> configure priority for a BSR candidate. Note that you must also specify the <hash> (mask length) when specifying the <priority>. The default priority if you do not configure this parameter is 64.

Mode Global Configuration

Default The default hash parameter value is 10 and the default priority parameter value is 64.

Examples To set the BSR candidate to the VLAN interface vlan2, with the optional mask length and BSR priority parameters, enter the commands shown below:

```
awplus# configure terminal
awplus(config)# ip pim bsr-candidate vlan2 20 30
```

To withdraw the address of vlan2 from being offered as a BSR candidate, enter:

```
awplus# configure terminal
awplus(config)# no ip pim bsr-candidate vlan2
```

To set the BSR candidate to the PPP interface ppp0, with the optional mask length and BSR priority parameters, enter the commands shown below:

```
awplus# configure terminal
awplus(config)# ip pim bsr-candidate ppp0 20 30
```

To withdraw the address of ppp0 from being offered as a BSR candidate, enter:

```
awplus# configure terminal
awplus(config)# no ip pim bsr-candidate ppp0
```

Command changes Version 5.4.7-1.1: VRF-lite support added SBx8100.

Version 5.4.8-1.1: VRF-lite support added x930, SBx908 GEN2.

ip pim cisco-register-checksum

Overview Use this command to configure the option to calculate the Register checksum over the whole packet. This command is used to inter-operate with older Cisco IOS versions.

Use the **no** variant of this command to disable this option.

Syntax `ip pim cisco-register-checksum`
`no ip pim cisco-register-checksum`

Default This command is disabled by default. By default, Register Checksum is calculated only over the header.

Mode Global Configuration

Example `awplus# configure terminal`
`awplus(config)# ip pim cisco-register-checksum`

Command changes Version 5.4.7-1.1: VRF-lite support added SBx8100.
Version 5.4.8-1.1: VRF-lite support added x930, SBx908 GEN2.

ip pim crp-cisco-prefix

Overview Use this command to interoperate with Cisco devices that conform to an earlier draft standard. Some Cisco devices might not accept candidate RPs with a group prefix number of zero. Note that the latest BSR specification prohibits sending RP advertisements with prefix 0. RP advertisements for the default IPv4 multicast group range 224/4 are sent with a prefix of 1.

Use the **no** variant of this command to revert to the default settings.

Syntax `ip pim crp-cisco-prefix`
`no ip pim crp-cisco-prefix`

Mode Global Configuration

Usage notes Cisco's BSR code does not conform to the latest BSR draft. It does not accept candidate RPs with a group prefix number of zero. To make the candidate RP work with a Cisco BSR, use the **ip pim crp-cisco-prefix** command when interoperating with older versions of Cisco IOS.

Example

```
awplus# configure terminal
awplus(config)# ip pim crp-cisco-prefix
awplus# configure terminal
awplus(config)# no ip pim crp-cisco-prefix
```

Related commands [ip pim rp-candidate](#)

Command changes Version 5.4.7-1.1: VRF-lite support added SBx8100.
Version 5.4.8-1.1: VRF-lite support added x930, SBx908 GEN2.

ip pim dr-priority

Overview Use this command to set the Designated Router priority value.
Use the **no** variant of this command to disable this function.

Syntax `ip pim dr-priority <priority>`
`no ip pim dr-priority [<priority>]`

Parameter	Description
<priority>	<0-4294967294> The Designated Router priority value. A higher value has a higher preference.

Default The default is 1. The negated form of this command restores the value to the default.

Mode Interface Configuration for a VLAN, Eth, or a PPP interface.

Examples To set the Designated Router priority value to 11234 for the VLAN interface vlan2, apply the commands as shown below:

```
awplus# configure terminal
awplus(config)# interface vlan2
awplus(config-if)# ip pim dr-priority 11234
```

To disable the Designated Router priority value for the VLAN interface vlan2, apply the commands as shown below:

```
awplus# configure terminal
awplus(config)# interface vlan2
awplus(config-if)# no ip pim dr-priority
```

To set the Designated Router priority value to 11234 for the PPP interface ppp0, apply the commands as shown below:

```
awplus# configure terminal
awplus(config)# interface ppp0
awplus(config-if)# ip pim dr-priority 11234
```

To disable the Designated Router priority value for the PPP interface ppp0, apply the commands as shown below:

```
awplus# configure terminal
awplus(config)# interface ppp0
awplus(config-if)# no ip pim dr-priority
```

Related commands [ip pim ignore-rp-set-priority](#)

ip pim exclude-genid

Overview Use this command to exclude the GenID option from Hello packets sent out by the PIM module on a particular interface. This command is used to inter-operate with older Cisco IOS versions.

Use the **no** variant of this command to revert to default settings.

Syntax `ip pim exclude-genid`
`no ip pim exclude-genid`

Default By default, this command is disabled; the GenID option is included.

Mode Interface Configuration for a VLAN, Eth, or a PPP interface.

Example To exclude the GenID option on interface vlan2, use the following commands:

```
awplus# configure terminal
awplus(config)# interface vlan2
awplus(config-if)# ip pim exclude-genid
```

To exclude the GenID option on interface ppp0, use the following commands:

```
awplus# configure terminal
awplus(config)# interface ppp0
awplus(config-if)# ip pim exclude-genid
```

ip pim ext-srcs-directly-connected

Overview Use this command to configure PIM to treat all source traffic arriving on the interface as though it was sent from a host directly connected to the interface.

Use the **no** variant of this command to configure PIM to treat only directly connected sources as directly connected.

Syntax `ip pim ext-srcs-directly-connected`
`no ip pim ext-srcs-directly-connected`

Default The **no** variant of this command is the default behavior.

Mode Interface Configuration for a VLAN, Eth, or a PPP interface.

Example To configure PIM to treat all sources as directly connected for VLAN interface `vlan2`, use the following commands:

```
awplus# configure terminal
awplus(config)# interface vlan2
awplus(config-if)# ip pim ext-srcs-directly-connected
```

To configure PIM to treat only directly connected sources as directly connected for VLAN interface `vlan2`, use the following commands:

```
awplus# configure terminal
awplus(config)# interface vlan2
awplus(config-if)# no ip pim ext-srcs-directly-connected
```

To configure PIM to treat all sources as directly connected for PPP interface `ppp0`, use the following commands:

```
awplus# configure terminal
awplus(config)# interface ppp0
awplus(config-if)# ip pim ext-srcs-directly-connected
```

To configure PIM to treat only directly connected sources as directly connected for PPP interface `ppp0`, use the following commands:

```
awplus# configure terminal
awplus(config)# interface ppp0
awplus(config-if)# no ip pim ext-srcs-directly-connected
```

ip pim hello-holdtime (PIM-SM)

Overview This command configures a hello-holdtime value. You cannot configure a hello-holdtime value that is less than the current hello-interval.

Use the **no** variant of this command to return it to its default of 3.5 * the current hello-interval.

Syntax `ip pim hello-holdtime <holdtime>`
`no ip pim hello-holdtime`

Parameter	Description
<code><holdtime></code>	<code><1-65535></code> The holdtime value in seconds (no fractional seconds are accepted).

Default The default hello-holdtime value is 3.5 * the current hello-interval.

Mode Interface Configuration for a VLAN, Eth, or a PPP interface.

Usage Each time the hello-interval is updated, the hello-holdtime is also updated, according to the following rules:

If the hello-holdtime is not configured; or if the hello-holdtime is configured and less than the current hello-interval value, it is modified to the (3.5 * hello-interval). Otherwise, it retains the configured value.

Example To set the hello-hold time value on interface vlan2 use the commands

```
awplus# configure terminal
awplus(config)# interface vlan2
awplus(config-if)# ip pim hello-holdtime 123
```

To set the hello-hold time value on interface ppp0, use the commands:

```
awplus# configure terminal
awplus(config)# interface ppp0
awplus(config-if)# ip pim hello-holdtime 123
```

ip pim hello-interval (PIM-SM)

Overview This command configures a hello-interval value.
Use the **no** variant of this command to reset the hello-interval to the default.

Syntax `ip pim hello-interval <interval>`
`no ip pim hello-interval`

Parameter	Description
<interval>	<1-65535> The value in seconds (no fractional seconds accepted).

Default The default hello-interval value is 30 seconds.

Mode Interface Configuration for a VLAN, Eth, or a PPP interface.

Usage When the hello-interval is configured, and the hello-holdtime is not configured, or when the configured hello-holdtime value is less than the new hello-interval value; the holdtime value is modified to the (3.5 * hello-interval). Otherwise, the hello-holdtime value is the configured value.

Example To set the hello-interval value on interface vlan2, use the commands:

```
awplus# configure terminal
awplus(config)# interface vlan2
awplus(config-if)# ip pim hello-interval 123
```

To set the hello-interval value on interface ppp0, use the commands:

```
awplus# configure terminal
awplus(config)# interface ppp0
awplus(config-if)# ip pim hello-interval 123
```

ip pim ignore-rp-set-priority

Overview Use this command to ignore the RP-SET priority value, and use only the hashing mechanism for RP selection.

This command is used to inter-operate with older Cisco IOS versions.

Use the **no** variant of this command to disable this setting.

Syntax `ip pim ignore-rp-set-priority`
`no ip pim ignore-rp-set-priority`

Mode Global Configuration

Example `awplus# configure terminal`
`awplus(config)# ip pim ignore-rp-set-priority`

ip pim jp-timer

Overview Use this command to set the PIM-SM join/prune timer. Note that the value the device puts into the holdtime field of the join/prune packets it sends to its neighbors is 3.5 times the join/prune timer value set using this command.

Use the **no** variant of this command to return the PIM-SM join/prune timer to its default value of 60 seconds, which corresponds to a join/prune packet holdtime of 210 seconds.

Syntax `ip pim jp-timer <1-65535>`
`no ip pim jp-timer [<1-65535>]`

Parameter	Description
<1-65535>	Specifies the join/prune timer value. The default value is 60 seconds.

Default The default join/prune timer value is 60 seconds.

Mode Global Configuration

Example To set the join/prune timer value to 300 seconds, use the commands:

```
awplus# configure terminal  
awplus(config)# ip pim jp-timer 300
```

To return the join/prune timer to its default value of 60 seconds, use the commands:

```
awplus# configure terminal  
awplus(config)# no ip pim jp-timer
```

Command changes Version 5.4.7-1.1: VRF-lite support added SBx8100.
Version 5.4.8-1.1: VRF-lite support added x930, SBx908 GEN2.

ip pim register-rate-limit

Overview Use this command to configure the rate of register packets sent by this DR, in units of packets per second.

Use the **no** variant of this command to remove the limit.

Syntax `ip pim register-rate-limit <1-65535>`
`no ip pim register-rate-limit`

Parameter	Description
<code><1-65535></code>	Specifies the maximum number of packets that can be sent per second.

Mode Global Configuration

Example `awplus# configure terminal`
`awplus(config)# ip pim register-rate-limit 3444`

Command changes Version 5.4.7-1.1: VRF-lite support added SBx8100.
Version 5.4.8-1.1: VRF-lite support added x930, SBx908 GEN2.

ip pim register-rp-reachability

Overview Use this command to enable the RP reachability check for PIM Register processing at the DR. The default setting is no checking for RP-reachability.

Use the **no** variant of this command to disable this processing.

Syntax `ip pim register-rp-reachability`
`no ip pim register-rp-reachability`

Default This command is disabled; by default, there is no checking for RP-reachability.

Mode Global Configuration

Example `awplus# configure terminal`
`awplus(config)# ip pim register-rp-reachability`

Command changes Version 5.4.7-1.1: VRF-lite support added SBx8100.
Version 5.4.8-1.1: VRF-lite support added x930, SBx908 GEN2.

ip pim register-source

Overview Use this command to configure the source address of register packets sent by this DR, overriding the default source address, which is the address of the RPF interface toward the source host.

Use the **no** variant of this command to un-configure the source address of Register packets sent by this DR, reverting back to use the default source address that is the address of the RPF interface toward the source host.

Syntax `ip pim register-source [<source-address>|<interface>]`
`no ip pim register-source`

Parameter	Description
<code><source-address></code>	The IP address, entered in the form A.B.C.D, to be used as the source of the register packets.
<code><interface></code>	The name of the interface to be used as the source of the register packets.

Usage notes The configured address must be a reachable address to be used by the RP to send corresponding Register-Stop messages in response. It is normally the local loopback interface address, but can also be a physical address. This address must be advertised by unicast routing protocols on the DR. The configured interface does not have to be PIM enabled.

Mode Global Configuration

Example `awplus# configure terminal`
`awplus(config)# ip pim register-source 10.10.1.3`

Command changes Version 5.4.7-1.1: VRF-lite support added SBx8100.
Version 5.4.8-1.1: VRF-lite support added x930, SBx908 GEN2.

ip pim register-suppression

Overview Use this command to configure the register-suppression time, in seconds, overriding the default of 60 seconds. Configuring this value modifies register-suppression time at the DR. Configuring this value at the RP modifies the RP-keepalive-period value if the `ip pim rp-register-kat` command is not used.

Use the **no** variant of this command to reset the value to its default of 60 seconds.

Syntax `ip pim register-suppression <1-65535>`
`no ip pim register-suppression`

Mode Global Configuration

Example `awplus# configure terminal`
`awplus(config)# ip pim register-suppression 192`

Command changes Version 5.4.7-1.1: VRF-lite support added SBx8100.
Version 5.4.8-1.1: VRF-lite support added x930, SBx908 GEN2.

ip pim rp-address

Overview Use this command to statically configure the RP (Rendezvous Point) address for multicast groups.

Use the **no** variant of this command to remove a statically configured RP address for multicast groups.

Syntax

```
ip pim rp-address <ip-address> group-list <group-prefix>
[override]

no ip pim rp-address <ip-address> group-list <group-prefix>
[override]
```

Parameter	Description
<ip-address>	IP address of RP, entered in the form A.B.C.D.
<group-prefix>	Multicast group IP prefix address of RP, entered in the form A.B.C.D/M
override	Enables statically defined RPs to override dynamically learned RPs.

Mode Global Configuration

Usage notes The AlliedWare Plus PIM-SM implementation supports multiple static RPs. It also supports usage of static RP and the BSR (Bootstrap Router) mechanism simultaneously. The **ip pim rp-address** command is used to statically configure the RP address for multicast groups.

You need to understand the following information before using this command.

If the RP address configured by the BSR, and the statically configured RP address are both available for a group range, then the RP address configured through the BSR is chosen over the statically configured RP address, unless the 'override' parameter is specified, in which case, the static RP will be chosen.

After configuration, the RP address is inserted into a static RP group tree based on the configured group ranges. For each group range, multiple static RPs are maintained in a linked list. This list is sorted in a descending order of IP addresses. When selecting static RPs for a group range, the first element (which is the static RP with highest IP address) is chosen.

RP address deletion is handled by removing the static RP from all the existing group ranges and recalculating the RPs for existing TIB states if required.

NOTE: A unique RP address may only be specified once as a static RP.

Example

```
awplus# configure terminal
awplus(config)# ip pim rp-address 192.0.2.10 group-list
233.252.0.0/24 override
```

Figure 37-2: Output from the **show ip pim sparse-mode rp mapping** command

```
awplus#show ip pim sp rp mapping
PIM Group-to-RP Mappings
Group(s): 233.252.0.0/24, Static
  RP: 192.0.2.10
  Uptime: 00:00:17
```

**Related
commands**

[ip pim rp-candidate](#)

[ip pim rp-register-kat](#)

[show ip pim sparse-mode rp mapping](#)

**Command
changes**

Version 5.4.7-1.1: VRF-lite support added SBx8100.

Version 5.4.8-0.5: Replaced <acl> parameter with <group-list> parameter.

Version 5.4.8-1.1: VRF-lite support added x930, SBx908 GEN2.

ip pim rp-candidate

Overview Use this command to make the router an RP (Rendezvous Point) candidate, using the IP address of the specified interface.

Use the **no** variant of this command to remove the RP status set using the **ip pim rp-candidate** command.

Syntax `ip pim rp-candidate <interface> [priority <priority>] [interval <interval>]`
`no ip pim rp-candidate [<interface>]`

Parameter	Description
<interface>	Interface name
priority <priority>	<0-255> The priority for this device to be an RP candidate on this interface.
interval <interval>	The advertisement interval specified in the range <1-16383> (in seconds).

Default The priority value for a candidate RP is 0 by default until specified using the **priority** parameter.

Mode Global Configuration

Usage notes Note that entering the command **ip pim rp-candidate <interface>** without one of the optional **priority** or **interval** parameters will configure the candidate RP with a priority value of 0.

Examples To specify a priority of 3, use the following commands:

```
awplus# configure terminal
awplus(config)# ip pim rp-candidate vlan2 priority 3
```

To stop the device from being an RP candidate on vlan2, use the following commands:

```
awplus# configure terminal
awplus(config)# no ip pim rp-candidate vlan2
```

Related commands [ip pim rp-address](#)
[ip pim rp-register-kat](#)
[ip pim crp-cisco-prefix](#)

Command changes Version 5.4.7-1.1: VRF-lite support added SBx8100.
Version 5.4.8-1.1: VRF-lite support added x930, SBx908 GEN2.

ip pim rp-register-kat

Overview Use this command to configure the Keep Alive Time (KAT) for (S,G) states at the RP (Rendezvous Point) to monitor PIM-SM Register packets.

Use the **no** variant of this command to return the PIM-SM KAT timer to its default value of 210 seconds.

Syntax `ip pim rp-register-kat <1-65535>`
`no ip pim rp-register-kat`

Parameter	Description
<1-65535>	Specify the KAT timer in seconds. The default value is 210 seconds.

Mode Global Configuration

Default The default PIM-SM KAT timer value is 210 seconds.

Examples

```
awplus# configure terminal
awplus(config)# ip pim rp-register-kat 3454
awplus# configure terminal
awplus(config)# no ip pim rp-register-kat
```

Related commands [ip pim rp-address](#)
[ip pim rp-candidate](#)

Command changes Version 5.4.7-1.1: VRF-lite support added SBx8100.
Version 5.4.8-1.1: VRF-lite support added x930, SBx908 GEN2.

ip pim sparse-mode

Overview Use this command to enable PIM-SM on an interface.
Use the **no** variant of this command to disable PIM-SM on an interface.

Syntax ip pim sparse-mode
no ip pim sparse-mode

Mode Interface Configuration for a VLAN, Eth, or a PPP interface.

Examples To enable PIM-SM on vlan2, use the commands:

```
awplus# configure terminal
awplus(config)# interface vlan2
awplus(config-if)# ip pim sparse-mode
```

To disable PIM-SM on vlan2, use the commands:

```
awplus# configure terminal
awplus(config)# interface vlan2
awplus(config-if)# no ip pim sparse-mode
```

To enable PIM-SM on ppp0, use the commands:

```
awplus# configure terminal
awplus(config)# interface ppp0
awplus(config-if)# ip pim sparse-mode
```

To enable PIM-SM on ppp0, use the commands:

```
awplus# configure terminal
awplus(config)# interface ppp0
awplus(config-if)# no ip pim sparse-mode
```

ip pim sparse-mode join-prune-batching

Overview Use this command to enable batching of Join and Prune messages in PIM-SM. This functionality reduces the number of PIM packets that must be sent to maintain a large number of groups

When using VRF-lite, you can use this command to enable Join and Prune batching in PIM-SM for a named VRF instance.

Use the **no** variant of this command to disable batching of Join and Prune messages in PIM-SM.

Syntax `ip pim sparse-mode join-prune-batching`
`no ip pim sparse-mode join-prune-batching`

Syntax (VRF-lite) `ip pim [vrf <vrf-name>]sparse-mode join-prune-batching`
`no ip pim [vrf <vrf-name>]sparse-mode join-prune-batching`

Parameter	Description
vrf	Apply this command to a VRF instance.
<vrf-name>	The name of the VRF instance.

Default Disabled.

Mode Global Configuration

Examples To enable Join/Prune batching for PIM-SM, use the commands:

```
awplus# configure terminal
awplus(config)# ip pim sparse-mode join-prune-batching
```

To disable Join/Prune batching for PIM-SM, use the commands:

```
awplus# configure terminal
awplus(config)# no ip pim sparse-mode join-prune-batching
```

Example (VRF-lite) To enable Join/Prune batching for the VRF instance 'red', use the commands:

```
awplus# configure terminal
awplus(config)# ip pim vrf red sparse-mode join-prune-batching
```

To disable Join/Prune batching for the VRF instance 'red', use the commands:

```
awplus# configure terminal
awplus(config)# no ip pim vrf red sparse-mode
join-prune-batching
```

Related commands [ip pim sparse-mode wrong-vif-suppression](#)

Command changes Version 5.4.8-2.3: command added.

ip pim sparse-mode passive

Overview Use this command to enable and disable passive mode operation for local members on an interface.

Use the **no** variant of this command to disable passive mode operation for local members on an interface.

Syntax ip pim sparse-mode passive
no ip pim sparse-mode passive

Mode Interface Configuration for a VLAN, Eth, or a PPP interface.

Usage Passive mode essentially stops PIM transactions on the interface, allowing only IGMP mechanism to be active. To turn off passive mode, use the **no ip pim sparse-mode passive** or the **ip pim sparse-mode** command. To turn off PIM activities on an interface, use the **no ip pim sparse-mode** command.

Examples To enable passive mode on vlan2, use the following commands:

```
awplus# configure terminal
awplus(config)# interface vlan2
awplus(config-if)# ip pim sparse-mode passive
```

To disable passive mode on vlan2, use the following commands:

```
awplus# configure terminal
awplus(config)# interface vlan2
awplus(config-if)# no ip pim sparse-mode passive
```

To enable passive mode on ppp0, use the following commands:

```
awplus# configure terminal
awplus(config)# interface ppp0
awplus(config-if)# ip pim sparse-mode passive
```

To disable passive mode on ppp0, use the following commands:

```
awplus# configure terminal
awplus(config)# interface ppp0
awplus(config-if)# no ip pim sparse-mode passive
```

ip pim sparse-mode wrong-vif-suppression

Overview Use this command to permit or block multicast packets that arrive on the wrong interface.

When using VRF-lite, you can use this command to enable wrong VIF suppression for a named VRF instance.

Use the **no** variant of this command to disable wrong VIF suppression.

Syntax `ip pim sparse-mode wrong-vif-suppression`
`no ip pim sparse-mode wrong-vif-suppression`

Syntax (VRF-lite) `ip pim [vrf <vrf-name>] sparse-mode wrong-vif-suppression`
`no ip pim [vrf <vrf-name>] sparse-mode wrong-vif-suppression`

Parameter	Description
vrf	Apply this command to a VRF instance.
<vrf-name>	The name of the VRF instance.

Default Disabled.

Mode Global Configuration

Usage notes This command enables wrong VIF suppression for PIM sparse-mode. Wrong VIF suppression prevents multicast packets received on the wrong upstream interface from being copied to the CPU.

Examples To enable wrong VIF suppression, use the commands:

```
awplus# configure terminal
awplus(config)# ip pim sparse-mode wrong-vif-suppression
```

To disable wrong VIF suppression, use the commands:

```
awplus# configure terminal
awplus(config)# no ip pim sparse-mode wrong-vif-suppression
```

Example (VRF-lite) To enable wrong VIF suppression for the VRF instance 'green', use the commands:

```
awplus# configure terminal
awplus(config)# ip pim vrf green sparse-mode
wrong-vif-suppression
```

To disable wrong VIF suppression for the VRF instance 'green', use the commands:

```
awplus# configure terminal
awplus(config)# no ip pim vrf green sparse-mode
wrong-vif-suppression
```

Related commands [ip pim sparse-mode join-prune-batching](#)

Command changes Version 5.4.8-2.3: command added.

ip pim spt-threshold

Overview This command turns on the ability for the last-hop PIM router to switch to SPT (shortest-path tree).

The **no** variant of this command turns off the ability for the last-hop PIM router to switch to SPT.

NOTE: *The switching to SPT happens either at the receiving of the first data packet, or not at all; it is not rate-based.*

Syntax ip pim spt-threshold
no ip pim spt-threshold

Mode Global Configuration

Examples To enable the last-hop PIM-SM router to switch to SPT, use the following commands:

```
awplus# configure terminal  
awplus(config)# ip pim spt-threshold
```

To stop the last-hop PIM-SM router from being able to switch to SPT, use the following commands:

```
awplus# configure terminal  
awplus(config)# no ip pim spt-threshold
```

Command changes Version 5.4.7-1.1: VRF-lite support added SBx8100.
Version 5.4.8-1.1: VRF-lite support added x930, SBx908 GEN2.

ip pim ssm

Overview Use this command to define the Source Specific Multicast (SSM) range of IP multicast addresses. The default keyword defines the SSM range as 232/8.

Use the **no** variant of this command to disable the SSM range.

Syntax `ip pim ssm default`
`no ip pim ssm`

Default By default, the command is disabled.

Mode Global Configuration

Usage When an SSM range of IP multicast addresses is defined by the `ip pim ssm` command, the `no (*,G)` or `(S,G,rpt)` state will be initiated for groups in the SSM range.

The messages corresponding to these states will not be accepted or originated in the SSM range.

Examples The following commands show how to set PIM-SSM as default:

```
awplus# configure terminal
awplus(config)# ip pim ssm default
```

The following commands show how to disable PIM-SSM:

```
awplus# configure terminal
awplus(config)# no ip pim ssm
```

service pim

Overview Use this command to enable PIM sparse mode services.
Use the **no** version of the command to disable unused PIM sparse mode services.

Syntax `service pim`
`no service pim`

Default Enabled

Mode Global Configuration

Usage notes Sometimes it may be desirable to disable unused services, in order to reduce memory use.
Disabling the PIM services will only take effect after you save the configuration and restart the device.

Example To disable the PIM sparse mode service, use the commands:

```
awplus# configure terminal
awplus(config)# no service pim
```

Output Figure 37-3: Example output from **no service pim**

```
awplus(config)#no service pim
% Save the config and restart the device for this change to take
effect
```

Command changes Version 5.5.0-0.1: command added

show debugging pim sparse-mode

Overview This command displays the status of the debugging of the system.
For information on filtering and saving command output, see the [“Getting Started with AlliedWare Plus” Feature Overview and Configuration Guide](#).

Syntax `show debugging pim sparse-mode`

Mode User Exec and Privileged Exec

Example To display PIM-SM debugging settings, use the command:

```
awplus# show debugging pim sparse-mode
```

Figure 37-4: Output from **show debugging pim sparse-mode**

```
Debugging status:
PIM event debugging is on
PIM Hello THT timer debugging is on
PIM event debugging is on
PIM MFC debugging is on
PIM state debugging is on
PIM packet debugging is on
PIM incoming packet debugging is on
PIM outgoing packet debugging is on
```

Related commands [debug pim sparse-mode](#)

Command changes Version 5.4.7-1.1: VRF-lite support added SBx8100.
Version 5.4.8-1.1: VRF-lite support added x930, SBx908 GEN2.

show ip pim sparse-mode bsr-router

Overview Use this command to show the Bootstrap Router (BSR) (v2) address.
For information on filtering and saving command output, see the [“Getting Started with AlliedWare Plus” Feature Overview and Configuration Guide](#).

Syntax `show ip pim sparse-mode bsr-router`

Mode User Exec and Privileged Exec

Output Figure 37-5: Output from the **show ip pim sparse-mode bsr-router** command

```
PIMv2 Bootstrap information
BSR address: 10.10.11.35 (?)
Uptime:      00:00:38, BSR Priority: 0, Hash mask length: 10
Expires:     00:01:32
Role: Non-candidate BSR
State: Accept Preferred
```

Related commands [show ip pim sparse-mode rp mapping](#)
[show ip pim sparse-mode neighbor](#)

Command changes Version 5.4.7-1.1: VRF-lite support added SBx8100.
Version 5.4.8-1.1: VRF-lite support added x930, SBx908 GEN2.

show ip pim sparse-mode interface

Overview Use this command to show PIM-SM interface information.

For information on filtering and saving command output, see the [“Getting Started with AlliedWare Plus” Feature Overview and Configuration Guide](#)

Syntax `show ip pim sparse-mode interface`

Mode User Exec and Privileged Exec

Example To display information about PIM-SM interfaces, use the command:

```
awplus# show ip pim sparse-mode interface
```

Output Figure 37-6: Example output from **show ip pim sparse-mode interface**

```
Total configured interfaces: 16   Maximum allowed: 31
Total active interfaces:      12

Address      Interface VIFindex Ver/   Nbr   DR      DR
            Mode     Count  Prior
192.168.1.53 vlan2     0      v2/S  2      2      192.168.1.53
192.168.10.53 vlan3     2      v2/S  0      2      192.168.10.53
...
```

Table 1: Parameters in the output from the **show ip pim sparse-mode interface** command

Parameters	Description
Total configured interfaces	The number of configured PIM Sparse Mode interfaces.
Maximum allowed	The maximum number of PIM Sparse Mode interfaces that can be configured.
Total active interfaces	The number of active PIM Sparse Mode interfaces.
Address	Primary PIM-SM address.
Interface	Name of the PIM-SM interface.
VIF Index	The Virtual Interface index of the interface.
Ver/Mode	PIM version/Sparse mode.
Nbr Count	Neighbor count of the PIM-SM interface.

Table 1: Parameters in the output from the **show ip pim sparse-mode interface** command (cont.)

Parameters	Description
DR Priority	Designated Router priority.
DR	The IP address of the Designated Router.

Related commands

- [ip pim sparse-mode](#)
- [show ip pim sparse-mode rp mapping](#)
- [show ip pim sparse-mode neighbor](#)

Command changes

- Version 5.4.7-1.1: VRF-lite support added SBx8100.
- Version 5.4.8-1.1: VRF-lite support added x930, SBx908 GEN2.

show ip pim sparse-mode interface detail

Overview Use this command to show detailed information on a PIM-SM interface.
For information on filtering and saving command output, see the [“Getting Started with AlliedWare Plus” Feature Overview and Configuration Guide](#).

Syntax `show ip pim sparse-mode interface detail`

Mode User Exec and Privileged Exec

Output Figure 37-7: Example output from the **show ip pim sparse-mode interface detail** command

```
vlan3 (vif 3):  
  Address 192.168.1.149, DR 192.168.1.149  
  Hello period 30 seconds, Next Hello in 15 seconds  
  Triggered Hello period 5 seconds  
  Neighbors:  
    192.168.1.22  
  
vlan2 (vif 0):  
  Address 10.10.11.149, DR 10.10.11.149  
  Hello period 30 seconds, Next Hello in 18 seconds  
  Triggered Hello period 5 seconds  
  Neighbors:  
    10.10.11.4
```

Command changes Version 5.4.7-1.1: VRF-lite support added SBx8100.

Version 5.4.8-1.1: VRF-lite support added x930, SBx908 GEN2.

show ip pim sparse-mode local-members

Overview Use this command to show detailed local member information on an interface configured for PIM-SM. If you do not specify an interface then detailed local member information is shown for all interfaces configured for PIM-SM.

For information on filtering and saving command output, see the [“Getting Started with AlliedWare Plus” Feature Overview and Configuration Guide](#).

Syntax `show ip pim sparse-mode local-members [<interface>]`

Parameter	Description
<interface>	Optional. Specify the interface.

Mode User Exec and Privileged Exec

Example To show detailed PIM-SM information for all PIM-SM configured interfaces, use the command:

```
awplus# show ip pim sparse-mode local-members
```

To show detailed PIM-SM information for the PIM-SM configured interface vlan1, use the command:

```
awplus# show ip pim sparse-mode local-members vlan1
```

Output Figure 37-8: Example output from the **show ip pim sparse-mode local-members** command

```
awplus#show ip pim sparse-mode local-members
PIM Local membership information

vlan1:
  (*, 224.0.0.4) : Include

vlan203:
  (*, 223.0.0.3) : Include
```

Output Figure 37-9: Example output from the **show ip pim sparse-mode local-members** command on a specific interface.

```
awplus#show ip pim sparse-mode local-members vlan1
PIM Local membership information

vlan1:
  (*, 224.0.0.4) : Include
```

Command changes Version 5.4.7-1.1: VRF-lite support added SBx8100.

Version 5.4.8-1.1: VRF-lite support added x930, SBx908 GEN2.

show ip pim sparse-mode mroute

Overview Use this command to display the IP multicast routing table or the IP multicast routing table based on a specific address or addresses.

Syntax

```
show ip pim sparse-mode mroute brief
show ip pim sparse-mode mroute
show ip pim sparse-mode mroute <group-address>
show ip pim sparse-mode mroute <source-address>
show ip pim sparse-mode mroute <source-address> <group-address>
```

Parameter	Description
brief	Shows only a summary of the number of each type of multicast entry and the cache.
<group-address>	Group IP address, entered in the form A.B.C.D. Output is all multicast entries belonging to that group.
<source-address>	Source IP address, entered in the form A.B.C.D. Output is all multicast entries belonging to that source.

Mode Privileged Exec

Usage notes Note that when a feature license is enabled, the output for the **show ip pim sparse-mode mroute** command will only show 32 interfaces because of the terminal display width limit. Use the **show ip pim sparse-mode mroute detail** command to display detailed entries of the IP multicast routing table.

Example To display the IP multicast routing table for the address 40.40.40.11, enter the command:

```
awplus# show ip pim sparse-mode mroute 40.40.40.11
```

Output Figure 37-10: Example output from **show ip pim sparse-mode mroute brief**

```
awplus#show ip pim sparse-mode mroute brief
IP Multicast Routing Table

(*,*,RP) Entries: 0
(*,G) Entries: 0
(S,G) Entries: 99
(S,G,rpt) Entries: 99
FCR Entries: 0
MRIB Msg Cache Hit: 0
```

Output Figure 37-11: Example output from **show ip pim sparse-mode mroute**

```
awplus#show ip pim sparse-mode mroute
IP Multicast Routing Table

(*,*,RP) Entries: 0
(*,G) Entries: 0
(S,G) Entries: 99
(S,G,rpt) Entries: 99
FCR Entries: 0
MRIB Msg Cache Hit: 0

(10.200.0.2, 224.1.1.1)
RPF nbr: 0.0.0.0
RPF idx: None
SPT bit: 1
Upstream State: JOINED
  Local          1
  Joined         0
  Asserted Winner 0
  Asserted Loser  0
  Outgoing      1
  Interop      listener  rx-data  flags (ES,EDW,RXD,DAJ,EOE)
                0x00000000 0x00000000 0x00000001
(10.200.0.2, 224.1.1.1, rpt)
RP: 0.0.0.0
RPF nbr: 0.0.0.0
RPF idx: None
Upstream State: RPT NOT JOINED
  Local          0
  Pruned         0
  Outgoing      0
  Interop      listener  rx-data  flags (ES,EDW,RXD,DAJ,EOE)
                0x00000000 0x00000000 0x00000001
...
```

Related commands [show ip pim sparse-mode mroute detail](#)

Command changes Version 5.4.7-1.1: VRF-lite support added to SBx8100.
Version 5.4.8-1.1: VRF-lite support added to x930, SBx908 GEN2.
Version 5.4.8-2.1: **brief** parameter added.

show ip pim sparse-mode mroute detail

Overview This command displays detailed entries of the IP multicast routing table, or detailed entries of the IP multicast routing table based on the specified address or addresses.

For information on filtering and saving command output, see the [“Getting Started with AlliedWare Plus” Feature Overview and Configuration Guide](#).

Syntax

```
show ip pim sparse-mode mroute [<group-address>] detail
show ip pim sparse-mode mroute [<source-address>] detail
show ip pim sparse-mode mroute [<group-address>
<source-address>] detail
show ip pim sparse-mode mroute [<source-address>
<group-address>] detail
```

Parameter	Description
<group-address>	Group IP address, entered in the form A.B.C.D. Output is all multicast entries belonging to that group.
<source-address>	Source IP address, entered in the form A.B.C.D. Output is all multicast entries belonging to that source.
detail	Show detailed information.

Usage notes Based on the group and source address, the output is the selected route if present in the multicast route tree.

Mode User Exec and Privileged Exec

Examples The following example commands show detailed entries for IP multicast routing tables:

```
awplus# show ip pim sparse-mode mroute detail
awplus# show ip pim sparse-mode mroute 40.40.40.11 detail
awplus# show ip pim sparse-mode mroute 224.1.1.1 detail
awplus# show ip pim sparse-mode mroute 224.1.1.1 40.40.40.11
detail
```

Figure 37-12: Example output from the **show ip pim sparse-mode mroute detail** command

```
IP Multicast Routing Table

(*,*,RP) Entries: 0
(*,G) Entries: 4
(S,G) Entries: 0
(S,G,rpt) Entries: 0
FCR Entries: 0

(*, 224.0.1.24) Uptime: 00:06:42
RP: 0.0.0.0, RPF nbr: None, RPF idx: None
Upstream:
State: JOINED, SPT Switch: Disabled, JT: off
Macro state: Join Desired,
Downstream:
vlan2:
State: NO INFO, ET: off, PPT: off
Assert State: NO INFO, AT: off
Winner: 0.0.0.0, Metric: 42949672951, Pref: 42949672951,
RPT bit: on
Macro state: Could Assert, Assert Track
Local Olist:
vlan2
```

**Command
changes**

Version 5.4.7-1.1: VRF-lite support added SBx8100.

Version 5.4.8-1.1: VRF-lite support added x930, SBx908 GEN2.

show ip pim sparse-mode neighbor

Overview Use this command to show the PIM-SM neighbor information.

For information on filtering and saving command output, see the [“Getting Started with AlliedWare Plus” Feature Overview and Configuration Guide](#).

Syntax `show ip pim sparse-mode neighbor [<interface>] [<ip-address>]
[detail]`

Parameter	Description
<interface>	Interface name. Show neighbors on an interface.
<ip-address>	Show neighbors with a particular address on an interface. The IP address entered in the form A.B.C.D.
detail	Show detailed information.

Mode Privileged Exec

Examples To show the neighbor information for all interfaces, use the command:

```
awplus# show ip pim sparse-mode neighbor
```

To show the neighbor information for vlan5, use the command:

```
awplus# show ip pim sparse-mode neighbor vlan5 detail
```

Output Figure 37-13: Example output from the **show ip pim sparse-mode neighbor** command

Neighbor Address	Interface	Uptime/Expires	Ver	DR
10.10.0.9	vlan2	00:55:33/00:01:44	v2	1 /
10.10.0.136	vlan2	00:55:20/00:01:25	v2	1 /
10.10.0.172	vlan2	00:55:33/00:01:32	v2	1 / DR
192.168.0.100	vlan3	00:55:30/00:01:20	v2	N / DR

Figure 37-14: Example output from the **show ip pim sparse-mode neighbor interface detail** command

```
Nbr 10.10.3.180 (vlan5), DR  
Expires in 55 seconds, uptime 00:00:15  
Holdtime: 70 secs, T-bit: off, lan delay: 1, Override interval: 3  
DR priority: 100, Gen ID: 625159467,  
Secondary addresses:  
192.168.30.1
```

Command changes Version 5.4.7-1.1: VRF-lite support added SBx8100.
Version 5.4.8-1.1: VRF-lite support added x930, SBx908 GEN2.

show ip pim sparse-mode nexthop

Overview Use this command to see the next hop information as used by PIM-SM.
For information on filtering and saving command output, see the [“Getting Started with AlliedWare Plus” Feature Overview and Configuration Guide](#)

Syntax `show ip pim sparse-mode nexthop`

Mode User Exec and Privileged Exec

Example `awplus# show ip pim sparse-mode nexthop`

Figure 37-15: Example output from the **show ip pim sparse-mode nexthop** command

Flags: N = New, R = RP, S = Source, U = Unreachable								
Destination	Type	Nexthop Num	Nexthop Addr	Nexthop	Nexthop Ifindex	Metric	Pref	Refcnt
10.10.0.9	.RS.	1	0.0.0.0	4	0	0	1	

Table 2: Parameters in output of the **show ip pim sparse-mode nexthop** command

Parameter	Description
Destination	The destination address for which PIM-SM requires next hop information.
Type	The type of destination, as indicated by the Flags description. N = New, R= RP, S = Source, U = Unreachable.
Nexthop Num	The number of next hops to the destination. PIM-SM always uses only 1 next hop.
Nexthop Addr	The address of the primary next hop gateway.
Nexthop IfIndex	The interface on which the next hop gateway can be reached.
Nexthop Name	The name of next hop interface.
Metric	The metric of the route towards the destination.
Preference	The preference of the route towards destination.
Refcnt	Only used for debugging.

Command changes Version 5.4.7-1.1: VRF-lite support added SBx8100.

Version 5.4.8-1.1: VRF-lite support added x930, SBx908 GEN2.

show ip pim sparse-mode packet statistics

Overview Use this command to display the current packet receive counts for PIM sparse-mode.

Syntax `show ip pim sparse-mode packet statistics`

Mode Privileged Exec

Example The following command displays the current packet receive counts for PIM sparse-mode:

```
awplus# configure terminal
awplus(config)# show ip pim sparse-mode statistics
```

Output Figure 37-16: Example output from **show ip pim sparse-mode statistics**

```
awplus(config)#show ip pim sparse-mode statistics
PIM-SM Receive Packet Statistics :
All PIM-SM      :   Total : 25   Valid : 25
Hello          :   Total : 14   Valid : 14
Register       :   Total : 5    Valid : 5
Register Stop  :   Total : 0    Valid : 0
Join/Prune     :   Total : 0    Valid : 0
Bootstrap     :   Total : 6    Valid : 6
Assert        :   Total : 0    Valid : 0
Candidate-RP  :   Total : 0    Valid : 0
```

Related commands [clear ip pim sparse-mode packet statistics](#)

Command changes Version 5.4.7-1.1: VRF-lite support added SBx8100.
Version 5.4.8-1.1: VRF-lite support added x930, SBx908 GEN2.

show ip pim sparse-mode rp-hash

Overview Use this command to display the Rendezvous Point (RP) to be chosen based on the group selected.

For information on filtering and saving command output, see the [“Getting Started with AlliedWare Plus” Feature Overview and Configuration Guide](#).

Syntax `show ip pim sparse-mode rp-hash <group-addr>`

Parameter	Description
<code><group-addr></code>	The group address for which to find the RP, entered in the form A.B.C.D.

Mode User Exec and Privileged Exec

Example `awplus# show ip pim sparse-mode rp-hash 224.0.1.3`

Figure 37-17: Output from the **show ip pim sparse-mode rp-hash** command

```
RP: 10.10.11.35  
Info source: 10.10.11.35, via bootstrap
```

Related commands [show ip pim sparse-mode rp mapping](#)

Command changes Version 5.4.7-1.1: VRF-lite support added SBx8100.

Version 5.4.8-1.1: VRF-lite support added x930, SBx908 GEN2.

show ip pim sparse-mode rp mapping

Overview Use this command to show group-to-RP (Rendezvous Point) mappings, and the RP set.

For information on filtering and saving command output, see the [“Getting Started with AlliedWare Plus” Feature Overview and Configuration Guide](#).

Syntax `show ip pim sparse-mode rp mapping`

Mode Privileged Exec

Example `awplus# show ip pim sparse-mode rp mapping`

Figure 37-18: Output from the **show ip pim sparse-mode rp mapping** command

```
PIM Group-to-RP Mappings
Group(s): 224.0.0.0/4
RP: 10.10.0.9
   Info source: 10.10.0.9, via bootstrap, priority 192
   Uptime: 16:52:39, expires: 00:02:50
```

Related commands [show ip pim sparse-mode rp-hash](#)

Command changes Version 5.4.7-1.1: VRF-lite support added SBx8100.

Version 5.4.8-1.1: VRF-lite support added x930, SBx908 GEN2.

undebbug all pim sparse-mode

Overview Use this command to disable all PIM-SM debugging.

Syntax `undebbug all pim sparse-mode`

Mode Privileged Exec

Example `awplus# undebbug all pim sparse-mode`

Related commands [debug pim sparse-mode](#)

Command changes Version 5.4.7-1.1: VRF-lite support added SBx8100.
Version 5.4.8-1.1: VRF-lite support added x930, SBx908 GEN2.

38

PIM-SMv6 Commands

Introduction

Overview This chapter provides an alphabetical reference of PIM-SMv6 commands. For IPv6 Multicast commands, see [Multicast Commands](#). For an overview of PIM-SMv6, see the [PIM-SMv6 Feature Overview and Configuration Guide](#).

IPv6 must be enabled on an interface with the `ipv6 enable` command, IPv6 forwarding must be enabled globally for routing IPv6 with the `ipv6 forwarding` command, and IPv6 multicasting must be enabled globally with the `ipv6 multicast-routing` command before using PIM-SMv6 commands.

Static IPv6 multicast routes take priority over dynamic IPv6 multicast routes. Use the `clear ipv6 mroute` command to clear static IPv6 multicast routes and ensure dynamic IPv6 multicast routes can take over from previous IPv6 static multicast routes.

NOTE: The IPv6 Multicast addresses shown can be derived from IPv6 unicast prefixes as per RFC 3306. The IPv6 unicast prefix reserved for documentation is 2001:0db8::/32 as per RFC 3849. Using the base /32 prefix the IPv6 multicast prefix for 2001:0db8::/32 is ff3x:20:2001:0db8::/64. Where an RP address is 2001:0db8::1 the embedded RP multicast prefix is ff7x:120:2001:0db8::/96. For ASM (Any-Source Multicast) the IPv6 multicast addresses allocated for documentation purposes are ff0x::0db8:0:0/96 as per RFC 6676. This is a /96 prefix so that it can be used with group IDs as per RFC 3307. These addresses should not be used for practical networks (other than for testing purposes), nor should they appear in any public network.

The IPv6 addresses shown use the address space 2001:0db8::/32, defined in RFC 3849 for documentation purposes. These addresses should not be used for practical networks (other than for testing purposes) nor should they appear on any public network.

- Command List**
- “`clear ipv6 mroute pim`” on page 1959
 - “`clear ipv6 mroute pim sparse-mode`” on page 1960
 - “`clear ipv6 pim sparse-mode bsr rp-set *`” on page 1961
 - “`debug ipv6 pim sparse-mode`” on page 1962

- [“debug ipv6 pim sparse-mode packet”](#) on page 1964
- [“debug ipv6 pim sparse-mode timer”](#) on page 1965
- [“ipv6 pim anycast-rp”](#) on page 1967
- [“ipv6 pim bsr-border”](#) on page 1969
- [“ipv6 pim bsr-candidate”](#) on page 1971
- [“ipv6 pim cisco-register-checksum”](#) on page 1973
- [“ipv6 pim crp-cisco-prefix”](#) on page 1974
- [“ipv6 pim dr-priority”](#) on page 1975
- [“ipv6 pim exclude-genid”](#) on page 1977
- [“ipv6 pim ext-srcs-directly-connected”](#) on page 1978
- [“ipv6 pim hello-holdtime”](#) on page 1979
- [“ipv6 pim hello-interval”](#) on page 1981
- [“ipv6 pim ignore-rp-set-priority”](#) on page 1982
- [“ipv6 pim jp-timer”](#) on page 1983
- [“ipv6 pim neighbor-filter”](#) on page 1984
- [“ipv6 pim register-rate-limit”](#) on page 1985
- [“ipv6 pim register-rp-reachability”](#) on page 1986
- [“ipv6 pim register-source”](#) on page 1987
- [“ipv6 pim register-suppression”](#) on page 1988
- [“ipv6 pim rp-address”](#) on page 1989
- [“ipv6 pim rp-candidate”](#) on page 1991
- [“ipv6 pim rp embedded”](#) on page 1992
- [“ipv6 pim rp-register-kat”](#) on page 1993
- [“ipv6 pim sparse-mode”](#) on page 1994
- [“ipv6 pim sparse-mode passive”](#) on page 1995
- [“ipv6 pim spt-threshold”](#) on page 1996
- [“ipv6 pim ssm”](#) on page 1997
- [“ipv6 pim unicast-bsm”](#) on page 1998
- [“service pim6”](#) on page 1999
- [“show debugging ipv6 pim sparse-mode”](#) on page 2000
- [“show ipv6 pim sparse-mode bsr-router”](#) on page 2001
- [“show ipv6 pim sparse-mode interface”](#) on page 2002
- [“show ipv6 pim sparse-mode interface detail”](#) on page 2004
- [“show ipv6 pim sparse-mode local-members”](#) on page 2005
- [“show ipv6 pim sparse-mode mroute”](#) on page 2006

- [“show ipv6 pim sparse-mode mroute detail”](#) on page 2008
- [“show ipv6 pim sparse-mode neighbor”](#) on page 2010
- [“show ipv6 pim sparse-mode nexthop”](#) on page 2011
- [“show ipv6 pim sparse-mode rp-hash”](#) on page 2012
- [“show ipv6 pim sparse-mode rp mapping”](#) on page 2013
- [“show ipv6 pim sparse-mode rp nexthop”](#) on page 2014
- [“undebug all ipv6 pim sparse-mode”](#) on page 2016
- [“undebug ipv6 pim sparse-mode”](#) on page 2017

clear ipv6 mroute pim

Overview Use this command to clear all Multicast Forwarding Cache (MFC) entries in PIM-SMv6.

NOTE: Static IPv6 multicast routes take priority over dynamic IPv6 multicast routes. Use the *clear ipv6 mroute* command to clear static IPv6 multicast routes and ensure dynamic IPv6 multicast routes can take over from previous static IPv6 multicast routes.

Syntax `clear ipv6 mroute [*] pim sparse-mode`

Parameter	Description
*	Clears all PIM-SMv6 multicast routes. Using this command without this optional operator only deletes the multicast router table entries.

Mode Privileged Exec

Example
`awplus# clear ipv6 mroute pim sparse-mode`
`awplus# clear ipv6 mroute * pim sparse-mode`

clear ipv6 mroute pim sparse-mode

Overview Use this command to clear all multicast route table entries learned through PIM-SMv6 for a specified multicast group address, and optionally a specified multicast source address.

NOTE: *Static IPv6 multicast routes take priority over dynamic IPv6 multicast routes. Use the `clear ipv6 mroute` command to clear static IPv6 multicast routes and ensure dynamic IPv6 multicast routes can take over from previous static IPv6 multicast routes.*

Syntax

```
clear ipv6 mroute <Group-IPv6-add> pim sparse-mode  
clear ipv6 mroute <Group-IPv6-add> <Source-IPv6-add> pim  
sparse-mode
```

Parameter	Description
<Group-IPv6-add>	Specify a multicast group IPv6 address, entered in the form X:X::X:X.
<Source-IPv6-add>	Specify a source group IPv6 address, entered in the form X:X::X:X.

Mode Privileged Exec

Example

```
awplus# clear ipv6 mroute 2001:db8:: pim sparse-mode  
awplus# clear ipv6 mroute 2001:db8:: 2002:db8:: pim sparse-mode
```

clear ipv6 pim sparse-mode bsr rp-set *

Overview Use this command to clear all Rendezvous Point (RP) sets learned through the PIM-SMv6 Bootstrap Router (BSR).

NOTE: *Static IPv6 multicast routes take priority over dynamic IPv6 multicast routes. Use the `clear ipv6 mroute` command to clear static IPv6 multicast routes and ensure dynamic IPv6 multicast routes can take over from previous static IPv6 multicast routes.*

Syntax `clear ipv6 pim sparse-mode bsr rp-set *`

Parameter	Description
*	Clears all RP sets.

Mode Privileged Exec

Usage For multicast clients, note that one router will be automatically or statically designated as the RP, and all routers must explicitly join through the RP. A Designated Router (DR) sends periodic Join/Prune messages toward a group-specific RP for each group that it has active members.

For multicast sources, note that the Designated Router (DR) unicasts Register messages to the RP encapsulating the data packets from the multicast source. The RP forwards decapsulated data packets toward group members.

Example `awplus# clear ipv6 pim sparse-mode bsr rp-set *`

debug ipv6 pim sparse-mode

Overview Use this command to activate PIM-SMv6 debugging.

Use the no variant of this command to deactivate PIMv6 debugging. Note that the `undebug ipv6 pim sparse-mode` command is an alias of the no variant of this command.

Syntax `debug ipv6 pim sparse-mode [all] [events] [mfc] [mib] [nexthop] [nsm] [state] [timer]`
`no debug ipv6 pim sparse-mode [all] [events] [mfc] [mib] [nexthop] [nsm] [state] [timer]`

Parameter	Description
all	Activates/deactivates all PIM-SMv6 debugging.
events	Activates debug printing of PIM-SMv6 events.
mfc	Activates debug printing of MFC (Multicast Forwarding Cache).
mib	Activates debug printing of PIM-SMv6 MIBs.
nexthop	Activates debug printing of PIM-SMv6 next hop communications.
nsm	Activates debugging of PIM-SMv6 NSM (Network Services Module) communications.
state	Activates debug printing of state transition on all PIM-SMv6 FSMs.
timer	Activates debug printing of PIM-SMv6 timers.

Mode Privileged Exec and Global Configuration

Example `awplus# configure terminal`
`awplus(config)# terminal monitor`
`awplus(config)# debug ipv6 pim sparse-mode all`
`awplus# configure terminal`
`awplus(config)# terminal monitor`
`awplus(config)# debug ipv6 pim sparse-mode events`
`awplus# configure terminal`
`awplus(config)# terminal monitor`
`awplus(config)# debug ipv6 pim sparse-mode nexthop`

Validation output Figure 38-1: Example output from the **show debugging ipv6 pim sparse-mode** command after issuing **multiple debug ipv6 pim sparse-mode** commands

```
awplus#debug ipv6 pim sparse-mode state
awplus#debug ipv6 pim sparse-mode events
awplus#debug ipv6 pim sparse-mode packet
awplus#show debugging ipv6 pim sparse-mode
PIM-SMv6 debugging status:
  PIM event debugging is on
  PIM MFC debugging is off
  PIM state debugging is on
  PIM packet debugging is on
  PIM Hello HT timer debugging is off
  PIM Hello NLT timer debugging is off
  PIM Hello THT timer debugging is off
  PIM Join/Prune JT timer debugging is off
  PIM Join/Prune ET timer debugging is off
  PIM Join/Prune PPT timer debugging is off
  PIM Join/Prune KAT timer debugging is off
  PIM Join/Prune OT timer debugging is off
  PIM Assert AT timer debugging is off
  PIM Register RST timer debugging is off
  PIM Bootstrap BST timer debugging is off
  PIM Bootstrap CRP timer debugging is off
  PIM mib debugging is off
  PIM nsm debugging is off
  PIM nexthop debugging is off
```

Related commands [show debugging ipv6 pim sparse-mode](#)
[undebug all ipv6 pim sparse-mode](#)
[undebug ipv6 pim sparse-mode](#)

debug ipv6 pim sparse-mode packet

Overview Use this command to activate PIM-SMv6 packet debugging.
Use the no variant of this command to deactivate PIMv6 packet debugging.

Syntax debug ipv6 pim sparse-mode packet {in|out}
no debug ipv6 pim sparse-mode packet {in|out}

Parameter	Description
packet	Activates debug printing of incoming and/or outgoing IPv6 packets.
in	Specify incoming packet debugging.
out	Specify outgoing packet debugging.

Mode Privileged Exec and Global Configuration

Example

```
awplus# configure terminal
awplus(config)# terminal monitor
awplus(config)# debug ipv6 pim sparse-mode packet in
awplus# configure terminal
awplus(config)# terminal monitor
awplus(config)# debug ipv6 pim sparse-mode packet out
awplus# configure terminal
awplus(config)# terminal monitor
awplus(config)# no debug ipv6 pim sparse-mode packet in
awplus# configure terminal
awplus(config)# terminal monitor
awplus(config)# no debug ipv6 pim sparse-mode packet out
```

Related commands [show debugging ipv6 pim sparse-mode](#)
[undebug all ipv6 pim sparse-mode](#)

debug ipv6 pim sparse-mode timer

Overview Use this command to enable debugging for the specified PIM-SMv6 timers.

Use the **no** variants of this command to disable debugging for the specified PIM-SMv6 timers.

Syntax

```
debug ipv6 pim sparse-mode timer assert [at]
no debug ipv6 pim sparse-mode timer assert [at]
debug pim ipv6 sparse-mode timer bsr [bst|crp]
no debug pim ipv6 sparse-mode timer bsr [bst|crp]
debug pim ipv6 sparse-mode timer hello [ht|nlt|tht]
no debug pim ipv6 sparse-mode timer hello [ht|nlt|tht]
debug pim ipv6 sparse-mode timer joinprune [jt|et|ppt|kat|ot]
no debug pim ipv6 sparse-mode timer joinprune
[jt|et|ppt|kat|ot]
debug pim ipv6 sparse-mode timer register [rst]
no debug pim ipv6 sparse-mode timer register [rst]
```

Parameter	Description
assert	Enable or disable debugging for the Assert timers.
at	Enable or disable debugging for the Assert Timer.
bsr	Enable or disable debugging for the specified Bootstrap Router timer, or all Bootstrap Router timers.
bst	Enable or disable debugging for the Bootstrap Router: Bootstrap Timer.
crp	Enable or disable debugging for the Bootstrap Router: Candidate-RP Timer.
hello	Enable or disable debugging for the specified Hello timer, or all Hello timers.
ht	Enable or disable debugging for the Hello timer: Hello Timer.
nlt	Enable or disable debugging for the Hello timer: Neighbor Liveness Timer.
tht	Enable or disable debugging for the Hello timer: Triggered Hello Timer.
joinprune	Enable or disable debugging for the specified JoinPrune timer, or all JoinPrune timers.
jt	Enable or disable debugging for the JoinPrune timer: upstream Join Timer.
et	Enable or disable debugging for the JoinPrune timer: Expiry Timer.
ppt	Enable or disable debugging for the JoinPrune timer: PrunePending Timer.

Parameter	Description
kat	Enable or disable debugging for the JoinPrune timer: KeepAlive Timer.
ot	Enable or disable debugging for the JoinPrune timer: Upstream Override Timer.
register	Enable or disable debugging for the Register timers.
rst	Enable or disable debugging for the Register timer: Register Stop Timer.

Default By default, all debugging is disabled.

Mode Privileged Exec and Global Configuration

Examples To enable debugging for the PIM-SMv6 Bootstrap Router bootstrap timer, use the commands:

```
awplus(config)# debug ipv6 pim sparse-mode timer bsr bst
```

To enable debugging for the PIM-SMv6 Hello: neighbor liveness timer, use the command:

```
awplus(config)# debug ipv6 pim sparse-mode timer hello ht
```

To enable debugging for the PIM-SMv6 Joinprune expiry timer, use the command:

```
awplus# debug ipv6 pim sparse-mode timer joinprune et
```

To disable debugging for the PIM-SMv6 Register timer, use the command:

```
awplus# no debug ipv6 pim sparse-mode timer register
```

Related commands [show debugging ipv6 pim sparse-mode](#)

ipv6 pim anycast-rp

Overview Use this command to configure Anycast RP (Rendezvous Point) in an RP set.
Use the **no** variant of this command to remove the configuration.

Syntax `ipv6 pim anycast-rp <anycast-rp-address> <member-rp-address>`
`no ipv6 pim anycast-rp <anycast-rp-address>`
`[<member-rp-address>]`

Parameter	Description
<code><anycast-rp-address></code>	<code><X:X::X:X></code> Specify an Anycast IPv6 address to configure an Anycast RP (Rendezvous Point) in a RP set.
<code><member-rp-address></code>	<code><A:B::C:D></code> Specify an Anycast RP (Rendezvous Point)IPv6 address to configure an Anycast RP in a RP set.

Mode Global Configuration

Usage notes Anycast is a network addressing and routing scheme where data is routed to the nearest or best destination as viewed by the routing topology. Compared to unicast with a one-to-one association between network address and network endpoint, and multicast with a one-to-many association between network address and network endpoint; anycast has a one-to-many association between network address and network endpoint. For anycast, each destination address identifies a set of receiver endpoints, from which only one receiver endpoint is chosen.

Anycast is often implemented using BGP to simultaneously advertise the same destination IPv6 address range from many sources, resulting in packets addressed to destination addresses in this range being routed to the nearest source announcing the given destination IPv6 address.

Use this command to specify the Anycast RP configuration in the Anycast RP set. Use the **no** variant of this command to remove the Anycast RP configuration. Note that the member RP address is optional when using the **no** parameter to remove the Anycast RP configuration. removing the anycast RP address also removes the member RP address.

Examples The following example shows how to configure the Anycast RP address with **ipv6 pim anycast-rp**:

```
awplus# configure terminal
awplus(config)# ipv6 forwarding
awplus(config)# ipv6 multicast-routing
awplus(config)# ipv6 pim anycast-rp 2:2::2:2 20:20::20:20
```

The following example shows how to remove the Anycast RP in the RP set specifying only the anycast RP address with **no ipv6 pim anycast-rp**, but not specifying the member RP address:

```
awplus# configure terminal
awplus(config)# no ipv6 pim anycast-rp 2:2::2:2 20:20::20:20
```

ipv6 pim bsr-border

Overview Use the **ipv6 pim bsr-border** command to prevent Bootstrap Router (BSR) messages from being sent or received through an interface. The BSR border is the border of the PIM-SMv6 domain.

Use the **no** variant of this command to disable the configuration set with **ipv6 pim bsr-border**.

Syntax `ipv6 pim bsr-border`
`no ipv6 pim bsr-border`

Mode Interface Configuration for a VLAN, Eth or PPP interface.

Usage When this command is configured on an interface, no PIM-SMv6 BSR messages will be sent or received through the interface. Configure an interface bordering another PIM-SMv6 domain with this command to avoid BSR messages from being exchanged between the two PIM-SMv6 domains.

BSR messages should not be exchanged between different domains, because devices in one domain may elect Rendezvous Points (RPs) in the other domain, resulting in loss of isolation between the two PIM domains that would stop the PIM-SMv6 protocol from working as intended.

Examples The following example configures the VLAN interface vln2 to be the PIM-SMv6 domain border:

```
awplus# configure terminal
awplus(config)# ipv6 forwarding
awplus(config)# ipv6 multicast-routing
awplus(config)# interface vln2
awplus(config-if)# ipv6 enable
awplus(config-if)# ipv6 pim bsr-border
```

The following example removes the VLAN interface vln2 from the PIM-SMv6 domain border:

```
awplus# configure terminal
awplus(config)# interface vln2
awplus(config-if)# no ipv6 pim bsr-border
```

The following example configures the PPP interface ppp0 to be the PIM -SMv6 domain border:

```
awplus(config)# configure terminal
awplus(config)# ipv6 forwarding
awplus(config)# ipv6 multicast-routing
awplus(config)# interface ppp0
awplus(config-if)# ipv6 enable
awplus(config-if)# ipv6 pim bsr-border
```

The following example removes the PPP interface ppp0 from the PIM-SMv6 domain border:

```
awplus# configure terminal
awplus(config)# interface ppp0
awplus(config-if)# no ipv6 pim bsr-border
```

ipv6 pim bsr-candidate

Overview Use this command to give the device the candidate BSR (Bootstrap Router) status using the specified IPv6 address mask of the interface.

Use the **no** variant of this command to withdraw the address of the interface from being offered as a BSR candidate.

Syntax `ipv6 pim bsr-candidate <interface> [<hash>] [<priority>]`
`no ipv6 pim bsr-candidate [<interface>]`

Parameter	Description
<interface>	Specify the interface.
<hash>	<0-128> configure the hash mask length used for RP selection. The default hash value if you do not configure this parameter is 126.
<priority>	<0-255> configure priority for a BSR candidate. Note that you must also specify the <hash> (mask length) when specifying the <priority>. The default priority if you do not configure this parameter is 64.

Mode Global Configuration

Default The default hash parameter value is 126 and the default priority parameter value is 64.

Examples To set the BSR candidate to the VLAN interface vlan2, with the optional mask length and BSR priority parameters, enter the commands shown below:

```
awplus# configure terminal
awplus(config)# ipv6 forwarding
awplus(config)# ipv6 multicast-routing
awplus(config)# ipv6 pim bsr-candidate vlan2 20 30
```

To withdraw the address of vlan2 from being offered as a BSR candidate, enter:

```
awplus# configure terminal
awplus(config)# no ipv6 pim bsr-candidate vlan2
```

To set the BSR candidate to the PPP interface ppp0, with the optional mask length and BSR priority parameters, enter the commands shown below:

```
awplus# configure terminal
awplus(config)# ipv6 forwarding
awplus(config)# ipv6 multicast-routing
awplus(config)# ipv6 pim bsr-candidate ppp0 20 30
```

To withdraw the address of ppp0 from being offered as a BSR candidate, enter:

```
awplus# configure terminal
```

```
awplus(config)# no ipv6 pim bsr-candidate ppp0
```

ipv6 pim cisco-register-checksum

Overview Use this command to configure the option to calculate the Register Checksum over the whole packet. This command is used to inter-operate with older Cisco IOS versions.

Use the **no** variant of this command to disable this option.

Syntax `ipv6 pim cisco-register-checksum`
`no ipv6 pim cisco-register-checksum`

Default This command is disabled by default. By default, Register Checksum is calculated only over the header.

Mode Global Configuration

Example

```
awplus# configure terminal
awplus(config)# ipv6 forwarding
awplus(config)# ipv6 multicast-routing
awplus(config)# ipv6 pim cisco-register-checksum
awplus# configure terminal
awplus(config)# no ipv6 pim cisco-register-checksum
```

ipv6 pim crp-cisco-prefix

Overview Use this command to interoperate with Cisco devices that conform to an earlier draft standard. Some Cisco devices might not accept candidate RPs with a group prefix number of zero. Note that the latest BSR specification prohibits sending RP advertisements with prefix 0.

Use the **no** variant of this command to revert to the default settings.

Syntax `ipv6 pim crp-cisco-prefix`
`no ipv6 pim crp-cisco-prefix`

Mode Global Configuration

Usage Cisco's BSR code does not conform to the latest BSR draft, it does not accept candidate RPs with a group prefix number of zero. To make the candidate RP work with a Cisco BSR, use the **ipv6 pim crp-cisco-prefix** command when interoperating with older versions of Cisco IOS.

Example

```
awplus# configure terminal
awplus(config)# ipv6 forwarding
awplus(config)# ipv6 multicast-routing
awplus(config)# ipv6 pim crp-cisco-prefix
awplus# configure terminal
awplus(config)# no ipv6 pim crp-cisco-prefix
```

Related commands [ipv6 pim rp-candidate](#)

ipv6 pim dr-priority

Overview Use this command to set the Designated Router priority value.
Use the **no** variant of this command to disable this function.

Syntax `ipv6 pim dr-priority <priority>`
`no ipv6 pim dr-priority [<priority>]`

Parameter	Description
<code><priority></code>	<code><0-4294967294></code> Specify the Designated Router priority value. Note that a higher value has a higher preference or higher priority.

Default The default value is 1. The negated form of this command restores the value to the default.

Mode Interface Configuration for a VLAN, Eth or PPP interface.

Examples To set the Designated Router priority value to 11234 for the VLAN interface `vlan2`, apply the commands as shown below:

```
awplus# configure terminal
awplus(config)# ipv6 forwarding
awplus(config)# ipv6 multicast-routing
awplus(config)# interface vlan2
awplus(config-if)# ipv6 enable
awplus(config-if)# ipv6 pim dr-priority 11234
```

To disable the Designated Router priority value for the VLAN interface `vlan2`, apply the commands as shown below:

```
awplus# configure terminal
awplus(config)# interface vlan2
awplus(config-if)# no ipv6 pim dr-priority
```

To set the Designated Router priority value to 11234 for the PPP interface `ppp0`, apply the commands as shown below:

```
awplus# configure terminal
awplus(config)# ipv6 forwarding
awplus(config)# ipv6 multicast-routing
awplus(config)# interface ppp0
awplus(config-if)# ipv6 enable
awplus(config-if)# ipv6 pim dr-priority 11234
```

To disable the Designated Router priority value for the PPP interface ppp0, apply the commands as shown below:

```
awplus# configure terminal
awplus(config)# interface ppp0
awplus(config-if)# no ipv6 pim dr-priority
```

Related commands [ipv6 pim ignore-rp-set-priority](#)

ipv6 pim exclude-genid

Overview Use this command to exclude the GenID option from Hello packets sent out by the PIM-SMv6 module on a particular interface. This command is used to inter-operate with older Cisco IOS versions.

Use the **no** variant of this command to revert to default settings.

Syntax `ipv6 pim exclude-genid`
`no ipv6 pim exclude-genid`

Default By default, this command is disabled; the GenID option is included.

Mode Interface Configuration for a VLAN, Eth or PPP interface.

Examples To exclude the GenID option in Hello packets on vlan2, use the commands:

```
awplus# configure terminal
awplus(config)# ipv6 forwarding
awplus(config)# ipv6 multicast-routing
awplus(config)# interface vlan2
awplus(config-if)# ipv6 enable
awplus(config-if)# ipv6 pim exclude-genid
```

To include the GenID option in Hello packets, use the commands:

```
awplus# configure terminal
awplus(config)# interface vlan2
awplus(config-if)# no ipv6 pim exclude-genid
```

To exclude the GenID option in Hello packets on ppp0, use the commands:

```
awplus# configure terminal
awplus(config)# ipv6 forwarding
awplus(config)# ipv6 multicast-routing
awplus(config)# interface ppp0
awplus(config-if)# ipv6 enable
awplus(config-if)# ipv6 pim exclude-genid
```

ipv6 pim ext-srcs-directly-connected

Overview Use this command to configure PIM-SMv6 to treat all source traffic arriving on the interface as though it was sent from a host directly connected to the interface.

Use the **no** variant of this command to configure PIM-SMv6 to treat only directly connected sources as directly connected.

Syntax `ipv6 pim ext-srcs-directly-connected`
`no ipv6 pim ext-srcs-directly-connected`

Default The **no** variant of this command is the default behavior.

Mode Interface Configuration for a VLAN, Eth or PPP interface.

Example To configure PIM-SMv6 to treat all sources as directly connected for VLAN interface `vlan2`, use the following commands:

```
awplus# configure terminal
awplus(config)# ipv6 forwarding
awplus(config)# ipv6 multicast-routing
awplus(config)# interface vlan2
awplus(config-if)# ipv6 enable
awplus(config-if)# ipv6 pim ext-srcs-directly-connected
```

To configure PIM-SMv6 to treat only directly connected sources as directly connected for VLAN interface `vlan2`, use the following commands:

```
awplus# configure terminal
awplus(config)# interface vlan2
awplus(config-if)# no ipv6 pim ext-srcs-directly-connected
```

To configure PIM to treat all sources as directly connected for PPP interface `ppp0`, use the following commands:

```
awplus# configure terminal
awplus(config)# ipv6 forwarding
awplus(config)# ipv6 multicast-routing
awplus(config)# interface ppp0
awplus(config-if)# ipv6 enable
awplus(config-if)# ipv6 pim ext-srcs-directly-connected
```

To configure PIM to treat only directly connected sources as directly connected for PPP interface `ppp0`, use the following commands:

```
awplus# configure terminal
awplus(config)# interface ppp0
awplus(config-if)# no ipv6 pim ext-srcs-directly-connected
```

ipv6 pim hello-holdtime

Overview This command configures a hello-holdtime value. You cannot configure a hello-holdtime value that is less than the current hello-interval.

Use the **no** variant of this command to return it to its default of 3.5 * the current hello-interval.

Syntax `ipv6 pim hello-holdtime <holdtime>`
`no ipv6 pim hello-holdtime`

Parameter	Description
<code><holdtime></code>	<code><1-65535></code> The holdtime value in seconds (no fractional seconds are accepted).

Default The default hello-holdtime value is 3.5 * the current hello-interval. The default hello-holdtime is restored using the negated form of this command.

Mode Interface Configuration for a VLAN, Eth or PPP interface.

Usage Each time the hello-interval is updated, the hello-holdtime is also updated, according to the following rules:

If the hello-holdtime is not configured; or if the hello-holdtime is configured and less than the current hello-interval value, it is modified to the (3.5 * hello-interval). Otherwise, it retains the configured value.

Examples To configure a hello-holdtime of 123 seconds on vlan2, use the commands:

```
awplus# configure terminal
awplus(config)# ipv6 forwarding
awplus(config)# ipv6 multicast-routing
awplus(config)# interface vlan2
awplus(config-if)# ipv6 enable
awplus(config-if)# ipv6 pim hello-holdtime 123
```

To reset the hello-holdtime to default, use the commands:

```
awplus# configure terminal
awplus(config)# interface vlan2
awplus(config-if)# no ipv6 pim hello-holdtime
```

To configure a hello-holdtime of 123 seconds on ppp0, use the commands

```
awplus# configure terminal
awplus(config)# ipv6 forwarding
awplus(config)# ipv6 multicast-routing
awplus(config)# interface ppp0
awplus(config-if)# ipv6 enable
awplus(config-if)# ipv6 pim hello-holdtime 123
```

ipv6 pim hello-interval

Overview This command configures a hello-interval value for PIM-SMv6. Use the **no** variant of this command to reset the hello-interval for PIM-SMv6 to the default.

Syntax `ipv6 pim hello-interval <interval>`
`no ipv6 pim hello-interval`

Parameter	Description
<interval>	<1-65535> The value in seconds (no fractional seconds accepted).

Default The default hello-interval value is 30 seconds. The default is restored using the negated form of this command.

Mode Interface Configuration for a VLAN, Eth or PPP interface.

Usage When the hello-interval is configured, and the hello-holdtime is not configured, or when the configured hello-holdtime value is less than the new hello-interval value; the holdtime value is modified to the (3.5 * hello-interval). Otherwise, the hello-holdtime value is the configured value.

Example To set the hello-interval to 123 seconds on vlan2, use the commands:

```
awplus# configure terminal
awplus(config)# ipv6 forwarding
awplus(config)# ipv6 multicast-routing
awplus(config)# interface vlan2
awplus(config-if)# ipv6 enable
awplus(config-if)# ipv6 pim hello-interval 123
```

To set the hello-interval to the default on vlan2, use the commands:

```
awplus# configure terminal
awplus(config)# interface vlan2
awplus(config-if)# no ipv6 pim hello-interval
```

To set the hello-interval to 123 seconds on ppp0, use the commands:

```
awplus# configure terminal
awplus(config)# ipv6 forwarding
awplus(config)# ipv6 multicast-routing
awplus(config)# interface ppp0
awplus(config-if)# ipv6 enable
awplus(config-if)# ipv6 pim hello-interval 123
```

ipv6 pim ignore-rp-set-priority

Overview Use this command to ignore the RP-SET priority value, and use only the hashing mechanism for RP selection.

Use the **no** variant of this command to disable this setting.

Syntax `ipv6 pim ignore-rp-set-priority`
`no ipv6 pim ignore-rp-set-priority`

Mode Global Configuration

Usage This command is used to inter-operate with older Cisco IOS versions.

Example

```
awplus# configure terminal
awplus(config)# ipv6 forwarding
awplus(config)# ipv6 multicast-routing
awplus(config)# ipv6 pim ignore-rp-set-priority
awplus# configure terminal
awplus(config)# no ipv6 pim ignore-rp-set-priority
```

ipv6 pim jp-timer

Overview Use this command to set the PIM-SMv6 join/prune timer. Note that the value set by the join/prune timer is the value that the device puts into the holdtime field of the join/prune packets it sends to its neighbors.

Use the **no** variant of this command to return the PIM-SMv6 join/prune timer to its default value of 210 seconds.

Syntax `ipv6 pim jp-timer <1-65535>`
`no ipv6 pim jp-timer [<1-65535>]`

Parameter	Description
<code><1-65535></code>	Specifies the Join/Prune timer value. The default value is 210 seconds.

Default The default PIM-SMv6 join/prune timer value is 210 seconds.

Mode Global Configuration

Example

```
awplus# configure terminal
awplus(config)# ipv6 forwarding
awplus(config)# ipv6 multicast-routing
awplus(config)# ipv6 pim jp-timer 300
awplus# configure terminal
awplus(config)# no ipv6 pim jp-timer
```

ipv6 pim neighbor-filter

Overview The AR3050S and AR4050S devices don't support access control list in 5.4.5-0.1 release.

This command enables filtering of neighbors on the VLAN interface. When configuring a neighbor filter, PIM-SMv6 will either not establish adjacency with the neighbor, or terminate adjacency with the existing neighbors if denied by the filtering IPv6 access list.

Use the **no** variant of this command to disable this function.

Syntax `ipv6 pim neighbor-filter <IPv6-accesslist>`
`no ipv6 pim neighbor-filter <IPv6-accesslist>`

Parameter	Description
<code><IPv6-accesslist></code>	Specify a Standard or an Extended software IPv6 access list name for the PIM-SMv6 neighbor filter.

Default By default, there is no neighbor filtering applied to an interface.

Mode Interface Configuration for a VLAN interface or a PPP interface.

Example To enable filtering on interface ppp0, use the commands:

```
awplus# configure terminal
awplus(config)# ipv6 forwarding
awplus(config)# ipv6 multicast-routing
awplus(config)# interface ppp0
awplus(config-if)# ipv6 enable
awplus(config-if)# ipv6 pim neighbor-filter filter1
```

ipv6 pim register-rate-limit

Overview Use this command to configure the rate of register packets sent by this DR, in units of packets per second. The configured rate is per (S, G) state, and is not a system wide rate.

Use the **no** variant of this command to remove the limit and reset to the default rate limit.

Syntax `ipv6 pim register-rate-limit <1-65535>`
`no ipv6 pim register-rate-limit`

Parameter	Description
<code><1-65535></code>	Specifies the maximum number of packets that can be sent per second.

Mode Global Configuration

Default The default is 0, as reset with the **no** variant, which also specifies an unlimited rate limit.

Examples

```
awplus# configure terminal
awplus(config)# ipv6 forwarding
awplus(config)# ipv6 multicast-routing
awplus(config)# ipv6 pim register-rate-limit 3444
awplus# configure terminal
awplus(config)# no ipv6 pim register-rate-limit 3444
```

ipv6 pim register-rp-reachability

Overview Use this command to enable the RP reachability check for PIMv6 Register processing at the DR. The default setting is no checking for RP-reachability. Use the **no** variant of this command to disable this processing.

Syntax `ipv6 pim register-rp-reachability`
`no ipv6 pim register-rp-reachability`

Default This command is disabled; by default, there is no checking for RP-reachability.

Mode Global Configuration

Examples `awplus# configure terminal`
`awplus(config)# ipv6 forwarding`
`awplus(config)# ipv6 multicast-routing`
`awplus(config)# ipv6 pim register-rp-reachability`
`awplus# configure terminal`
`awplus(config)# no ipv6 pim register-rp-reachability`

ipv6 pim register-source

Overview Use this command to configure the source IPv6 address of register packets sent by this DR, overriding the default source IPv6 address, which is the IPv6 address of the RPF interface toward the source host.

Use the **no** variant of this command to remove the IPv6 source address of Register packets sent by this DR, reverting back to use the default IPv6 source address that is the address of the RPF interface toward the source host.

Syntax `ipv6 pim register-source [<source-IPv6-address>|<interface>]`
`no ipv6 pim register-source`

Parameter	Description
<code><source-IPv6-address></code>	The IPv6 address, entered in the form X::X:X, to be used as the source of the register packets.
<code><interface></code>	The name of the interface to be used as the source of the register packets.

Usage The configured address must be a reachable address to be used by the RP to send corresponding Register-Stop messages in response. It is normally the local loopback IPv6 interface address, but can also be a physical IPv6 address. This IPv6 address must be advertised by unicast routing protocols on the DR. The configured interface does not have to be PIM-SMv6 enabled.

Mode Global Configuration

Examples To configure the register source as 3ffe::24:2, use the commands:

```
awplus# configure terminal
awplus(config)# ipv6 forwarding
awplus(config)# ipv6 multicast-routing
awplus(config)# ipv6 pim register-source 3ffe::24:2
```

To configure the register source as vlan2, use the commands:

```
awplus# configure terminal
awplus(config)# ipv6 forwarding
awplus(config)# ipv6 multicast-routing
awplus(config)# ipv6 pim register-source vlan2
```

To change back to the default, use the commands:

```
awplus# configure terminal
awplus(config)# ipv6 forwarding
awplus(config)# ipv6 multicast-routing
awplus(config)# no ipv6 pim register-source
```

ipv6 pim register-suppression

Overview Use this command to configure the register-suppression time, in seconds, overriding the default of 60 seconds.

Use the **no** variant of this command to reset the value to its default of 60 seconds.

Syntax `ipv6 pim register-suppression <1-65535>`
`no ipv6 pim register-suppression`

Parameter	Description
<1-65535>	Register suppression on time in seconds.

Mode Global Configuration

Default The default PIM-SMv6 register suppression time is 60 seconds, and is restored with the no variant of this command.

Usage Configuring this value modifies register-suppression time at the DR. Configuring this value at the RP modifies the RP-keepalive-period value if the `ipv6 pim rp-register-kat` command is not used.

Examples

```
awplus# configure terminal
awplus(config)# ipv6 forwarding
awplus(config)# ipv6 multicast-routing
awplus(config)# ipv6 pim register-suppression 192
awplus# configure terminal
awplus(config)# no ipv6 pim register-suppression
```

ipv6 pim rp-address

Overview The AR3050S and AR4050 devices don't support access control list in 5.4.5-0.1 release.

Use this command to statically configure RP (Rendezvous Point) address for IPv6 multicast groups.

Use the **no** variant of this command to remove a statically configured RP (Rendezvous Point) address for IPv6 multicast groups.

Syntax

```
ipv6 pimv6 rp-address <IPv6-address>  
no ipv6 pim rp-address <IPv6-address>
```

Parameter	Description
<IPv6-address>	Specify the IPv6 address of the Rendezvous Point, entered in the form X:X::X:X.

Mode Global Configuration

Usage notes The AlliedWare Plus™ PIM-SMv6 implementation supports multiple static RPs. It also supports usage of static-RP and BSR mechanism simultaneously. The **ipv6 pim rp-address** command is used to statically configure the RP address for IPv6 multicast groups.

You need to understand the following information before using this command.

If the RP-address that is configured by the BSR, and the RP-address that is configured statically, are both available for a group range, then the RP-address configured through BSR is chosen over the statically configured RP-address.

If multiple static-RPs are available for a group range, then one with the highest IPv6 address is chosen.

After configuration, the RP-address is inserted into a static-RP group tree based on the configured group ranges. For each group range, multiple static-RPs are maintained in a list. This list is sorted in a descending order of IPv6 addresses. When selecting static-RPs for a group range, the first element (which is the static-RP with highest IPv6 address) is chosen.

RP-address deletion is handled by removing the static-RP from all the existing group ranges and recalculating the RPs for existing TIB states if required.

Group mode and RP address mappings learned through BSR take precedence over mappings statistically defined by the **ipv6 pim rp-address** command. Commands with the **override** keyword take precedence over dynamically learned mappings.

Examples

```
awplus# configure terminal  
awplus(config)# no ipv6 pim rp-address 3ffe:30:30:5::153 G2
```

**Related
commands** [ipv6 pim rp-candidate](#)
[ipv6 pim rp-register-kat](#)

ipv6 pim rp-candidate

Overview Use this command to make the device an RP (Rendezvous Point) candidate, using the IPv6 address of the specified interface.

Use the **no** variant of this command to stop the device from being an RP candidate.

Syntax `ipv6 pim rp-candidate <interface> [priority <priority>|interval <interval>|grouplist <accesslist>]`
`no ipv6 pim rp-candidate [<interface>]`

Parameter	Description
<interface>	Specify an interface name.
<priority>	Specify the priority for the RP candidate in the range 0 to 255.
<interval>	Specify a candidate RP advertisement interval in the range 1 to 16383 (seconds).
<accesslist>	Specify a Standard or an Extended software IPv6 access list name.

Default The priority value for a candidate RP is 192 by default until specified using the **priority** parameter.

Mode Global Configuration

Usage notes Note that issuing the command **ipv6 pim rp-candidate <interface>** without optional **priority**, **interval**, or **grouplist** parameters will configure the candidate RP with a priority value of 192.

Examples To specify a priority of 3, use the following commands:

```
awplus# configure terminal
awplus(config)# ipv6 forwarding
awplus(config)# ipv6 multicast-routing
awplus(config)# ipv6 pim rp-candidate vlan2 priority 3
```

To stop the device from being an RP candidate on vlan2, use the following commands:

```
awplus# configure terminal
awplus(config)# no ipv6 pim rp-candidate vlan2
```

Related commands [ipv6 pim rp-address](#)
[ipv6 pim rp-register-kat](#)

ipv6 pim rp embedded

Overview Use this command to configure and enable embedded RP (Rendezvous Point) in PIM-SMv6.

This command only applies to the embedded RP group range **ff7x::/12** and **fffx::/12**.

Use the **no** variant of this command to disable embedded RP support. Since embedded RP support is enabled by default, use the **no** variant of this command to disable the default.

Syntax `ipv6 pim rp embedded`
`no ipv6 pim rp embedded`

Mode Global Configuration

Default Embedded RP is enabled by default in the AlliedWare Plus implementation of PIM-SMv6.

Examples The following example re-enables embedded RP support, the default state in PIM-SMv6:

```
awplus# configure terminal
awplus(config)# ipv6 forwarding
awplus(config)# ipv6 multicast-routing
awplus(config)# ipv6 pim rp embedded
```

The following example disables embedded RP support, which is enabled by default in PIM-SMv6:

```
awplus# configure terminal
awplus(config)# no ipv6 pim rp embedded
```

ipv6 pim rp-register-kat

Overview Use this command to configure the Keep Alive Time (KAT) for (S,G) states at the RP (Rendezvous Point) to monitor PIM-SMv6 Register packets.

Use the **no** variant of this command to return the PIM-SMv6 KAT timer to its default value of 210 seconds.

Syntax `ipv6 pim rp-register-kat <1-65535>`
`no ipv6 pim rp-register-kat`

Parameter	Description
<1-65536>	Specify the KAT timer in seconds. The default value is 210 seconds.

Mode Global Configuration

Default The default PIM-SMv6 KAT timer value is 210 seconds.

Examples

```
awplus# configure terminal
awplus(config)# ipv6 forwarding
awplus(config)# ipv6 multicast-routing
awplus(config)# ipv6 pim rp-register-kat 3454
awplus# configure terminal
awplus(config)# no ipv6 pim rp-register-kat
```

Related commands [ipv6 pim rp-address](#)
[ipv6 pim rp-candidate](#)

ipv6 pim sparse-mode

Overview Use this command to enable PIM-SMv6 on an interface.
Use the **no** variant of this command to disable PIM-SMv6 on an interface.

Syntax `ipv6 pim sparse-mode`
`no ipv6 pim sparse-mode`

Mode Interface Configuration for a VLAN, Eth or PPP interface.

Examples To enable PIM-SMv6 on vlan2, use the commands:

```
awplus# configure terminal
awplus(config)# ipv6 forwarding
awplus(config)# ipv6 multicast-routing
awplus(config)# interface vlan2
awplus(config-if)# ipv6 enable
awplus(config-if)# ipv6 pim sparse-mode
```

To disable PIM-SMv6 on vlan2, use the commands:

```
awplus# configure terminal
awplus(config)# interface vlan2
awplus(config-if)# no ipv6 pim sparse-mode
```

To enable PIM-SMv6 on ppp0, use the commands:

```
awplus# configure terminal
awplus(config)# ipv6 forwarding
awplus(config)# ipv6 multicast-routing
awplus(config)# interface ppp0
awplus(config-if)# ipv6 enable
awplus(config-if)# ipv6 pim sparse-mode
```

ipv6 pim sparse-mode passive

Overview Use this command to enable and disable PIM-SMv6 passive mode operation for local members on an interface.

Use the **no** variant of this command to disable PIM-SMv6 passive mode operation for local members on an interface.

Syntax `ipv6 pim sparse-mode passive`
`no ipv6 pim sparse-mode passive`

Mode Interface Configuration for a VLAN, Eth or PPP interface.

Usage Passive mode essentially stops PIM-SMv6 transactions on the interface, allowing only the MLD mechanism to be active.

Examples To enable passive mode on vlan2, use the commands

```
awplus# configure terminal
awplus(config)# ipv6 forwarding
awplus(config)# ipv6 multicast-routing
awplus(config)# interface vlan2
awplus(config-if)# ipv6 enable
awplus(config-if)# ipv6 pim sparse-mode passive
```

To disable passive mode on vlan2, use the commands

```
awplus# configure terminal
awplus(config)# interface vlan2
awplus(config-if)# no ipv6 pim sparse-mode passive
```

To enable passive mode on ppp0, use the commands

```
awplus# configure terminal
awplus(config)# ipv6 forwarding
awplus(config)# ipv6 multicast-routing
awplus(config)# interface ppp0
awplus(config-if)# ipv6 enable
awplus(config-if)# ipv6 pim sparse-mode passive
```

ipv6 pim spt-threshold

Overview This command turns on the ability for the last-hop PIM-SMv6 router to switch to SPT (shortest-path tree).

The **no** variant of this command turns off the ability for the last-hop PIM-SMv6 router to switch to SPT.

NOTE: *The switching to SPT happens either at the receiving of the first data packet, or not at all; it is not rate-based.*

Syntax `ipv6 pim spt-threshold`
`no ipv6 pim spt-threshold`

Mode Global Configuration

Examples To enable the last-hop PIM-SMv6 router to switch to SPT, use the following commands:

```
awplus# configure terminal
awplus(config)# ipv6 forwarding
awplus(config)# ipv6 multicast-routing
awplus(config)# ipv6 pim spt-threshold
```

To stop the last-hop PIM-SMv6 router from being able to switch to SPT, use the following commands:

```
awplus# configure terminal
awplus(config)# no ipv6 pim spt-threshold
```

ipv6 pim ssm

Overview Use this command to define the Source Specific Multicast (SSM) range of IPv6 multicast addresses. PIM-SMv6 routers will only install (S,G) entries for multicast groups (addresses) residing in the SSM range.

Use the **no** variant of this command to disable the SSM range.

Syntax `ipv6 pim ssm [default]`
`no ipv6 pim ssm`

Parameter	Description
default	Named Standard Access List. Use FF3x::/32 group range for SSM.

Default By default, the command is disabled.

Mode Global Configuration

Usage Any (*,G) or (S,G,rpt) joins received for multicast groups (addresses) within the range, are not installed in PIM-SMv6 mroute table.

Examples The following commands show how to set PIM-SSM as default:

```
awplus# configure terminal  
awplus(config)# ipv6 pim ssm default
```

The following commands show how to disable PIM-SSM:

```
awplus# configure terminal  
awplus(config)# no ipv6 pim ssm
```

ipv6 pim unicast-bsm

Overview Use this command to enable support for the sending and receiving of unicast Boot Strap Messages (BSM) on an interface.

Use the **no** variant of this command to disable the sending and receiving of unicast BSM on an interface.

Syntax `ipv6 pim unicast-bsm`
`no ipv6 pim unicast-bsm`

Mode Interface Configuration for a VLAN, Eth or PPP interface.

Default Unicast BSM is disabled by default on an interface.

Usage This command provides backward compatibility with older versions of the Boot Strap Router (BSR) specification, which directs unicast BSM to refresh the state of new or restarting neighbors. The current BSR specification defines a No Forward BSM to achieve the same result.

Examples To enable BSM messages on vlan2, use the commands:

```
awplus# configure terminal
awplus(config)# ipv6 forwarding
awplus(config)# ipv6 multicast-routing
awplus(config)# interface vlan2
awplus(config-if)# ipv6 enable
awplus(config-if)# ipv6 pim unicast-bsm
```

To disable BSM messages on vlan2, use the commands:

```
awplus# configure terminal
awplus(config)# interface vlan2
awplus(config-if)# no ipv6 pim unicast-bsm
```

service pim6

Overview Use this command to enable IPv6 PIM sparse mode services.
Use the **no** version of the command to disable unused IPv6 PIM sparse mode services.

Syntax `service pim6`
`no service pim6`

Default Enabled

Mode Global Configuration

Usage notes Sometimes it may be desirable to disable unused services, in order to reduce memory use.
Disabling the PIM services will only take effect after you save the configuration and restart the device.

Example To disable the IPv6 PIM sparse mode service, use the commands:

```
awplus# configure terminal
awplus(config)# no service pim6
```

Output Figure 38-2: Example output from **no service pim6**

```
awplus(config)#no service pim6
% Save the config and restart the device for this change to take
effect
```

Command changes Version 5.5.0-0.1: command added

show debugging ipv6 pim sparse-mode

Overview Use this command to see what debugging is turned on for PIM-SMv6.

For information on filtering and saving command output, see the [“Getting_Started with AlliedWare Plus” Feature Overview and Configuration_Guide](#).

Syntax `show debugging ipv6 pim sparse-mode`

Mode User Exec and Privileged Exec

Example To display PIM-SMv6 debugging settings, use the command:

```
awplus# show debugging ipv6 pim sparse-mode
```

Figure 38-3: Example output from the **show debugging ipv6 pim sparse-mode** command

```
awplus#show debugging ipv6 pim sparse-mode
Debugging status:
  PIM event debugging is on
  PIM MFC debugging is on
  PIM state debugging is on
  PIM packet debugging is on
  PIM Hello HT timer debugging is on
  PIM Hello NLT timer debugging is on
  PIM Hello THT timer debugging is on
  PIM Join/Prune JT timer debugging is on
  PIM Join/Prune ET timer debugging is on
  PIM Join/Prune PPT timer debugging is on
  PIM Join/Prune KAT timer debugging is on
  PIM Join/Prune OT timer debugging is on
  PIM Assert AT timer debugging is on
  PIM Register RST timer debugging is on
  PIM Bootstrap BST timer debugging is on
  PIM Bootstrap CRP timer debugging is on
```

Related commands [debug ipv6 pim sparse-mode](#)
[undebug ipv6 pim sparse-mode](#)

show ipv6 pim sparse-mode bsr-router

Overview Use this command to show the PIM-SMv6 Bootstrap Router (BSR) IPv6 address.

For information on filtering and saving command output, see the [“Getting_Started with AlliedWare Plus” Feature Overview and Configuration_Guide](#).

Syntax `show ipv6 pim sparse-mode bsr-router`

Mode User Exec and Privileged Exec

Example To display the BSR IPv6 address, use the command:

```
awplus# show ipv6 pim sparse-mode bsr-router
```

Output Figure 38-4: Example output from the **show ipv6 pim sparse-mode bsr-router** command

```
awplus#show ipv6 pim sparse-mode bsr-router
PIM6v2 Bootstrap information
  BSR address: 2001:203::213 (?)
  Uptime:      00:36:25, BSR Priority: 64, Hash mask length: 126
  Expires:     00:01:46
  Role:        Candidate BSR
  State:       Candidate BSR

Candidate RP: 2001:5::211(vlan5)
  Advertisement interval 60 seconds
  Next C-RP advertisement in 00:00:43
```

Related commands [show ipv6 pim sparse-mode rp mapping](#)
[show ipv6 pim sparse-mode neighbor](#)

show ipv6 pim sparse-mode interface

Overview Use this command to show PIM-SMv6 interface information.

For information on filtering and saving command output, see the [“Getting_Started with AlliedWare Plus” Feature Overview and Configuration_Guide](#).

Syntax `show ipv6 pim sparse-mode interface [detail]`

Parameter	Description
detail	Show detailed information.

Mode User Exec and Privileged Exec

Examples To display information about all PIM-SMv6 interfaces, use the command:

```
awplus# show ipv6 pim sparse-mode interface
```

```
awplus#show ipv6 pim sparse-mode interface
Interface VIFindex Ver/   Nbr   DR
           Mode   Count Priority
vlan2     0       v2/S   2     1
  Address      : fe80::207:e9ff:fe02:81d
  Global Address: 3ffe:192:168:1::53
  DR           : fe80::20e:cff:fe01:facc
vlan3     2       v2/S   2     1
  Address      : fe80::207:e9ff:fe02:21a2
  Global Address: 3ffe:192:168:10::53
  DR           : this system
```

Table 1: Parameters in the output from the **show ipv6 pim sparse-mode interface** command

Parameters	Description
Address	Primary PIM-SMv6 address.
Interface	Name of the PIM-SMv6 interface.
VIF Index	The Virtual Interface index of the interface.
Ver/Mode	PIMv6 version/Sparse mode.
Nbr Count	Neighbor count of the PIM-SMv6 interface.
DR Priority	Designated Router priority.
DR	The IPv6 address of the Designated Router.

Related commands

- ipv6 pim sparse-mode
- show ipv6 pim sparse-mode rp mapping
- show ipv6 pim sparse-mode neighbor

show ipv6 pim sparse-mode interface detail

Overview Use this command to show detailed PIM-SMv6 information for all PIM-SMv6 configured interfaces.

For information on filtering and saving command output, see the [“Getting Started with AlliedWare Plus” Feature Overview and Configuration Guide](#).

Syntax `show ipv6 pim sparse-mode interface detail`

Mode User Exec and Privileged Exec

Example To show detailed PIM-SMv6 information for all PIM-SMv6 configured interfaces, use the command:

```
awplus# show ipv6 pim sparse-mode interface detail
```

Output Figure 38-5: Example output from the **show ipv6 pim sparse-mode interface detail** command

```
awplus#show ipv6 pim sparse-mode interface detail
vlan2 (vif 0)
  Address fe80::207:e9ff:fe02:81d, DR fe80::20e:cff:fe01:facc
  Hello period 30 seconds, Next Hello in 21 seconds
  Triggered Hello period 5 seconds
  Secondary addresses:
    3ffe:192:168:1::53
  Neighbors:
    fe80::202:b3ff:fed4:69fe
    fe80::20e:cff:fe01:facc

vlan3 (vif 2):
  Address fe80::207:e9ff:fe02:21a2, DR fe80::207:e9ff:fe02:21a2
  Hello period 30 seconds, Next Hello in 20 seconds
  Triggered Hello period 5 seconds
  Secondary addresses:
    3ffe:192:168:10::53
  Neighbors:
```

show ipv6 pim sparse-mode local-members

Overview Use this command to show detailed local member information on an interface configured for PIM-SMv6. If you do not specify an interface then detailed local member information is shown for all interfaces configured for PIM-SMv6.

For information on filtering and saving command output, see the [“Getting_Started with AlliedWare Plus” Feature Overview and Configuration_Guide](#).

Syntax `show ipv6 pim sparse-mode local-members [<interface>]`

Parameter	Description
<interface>	Optional Specify the interface.

Mode User Exec and Privileged Exec

Example To show detailed PIM-SMv6 information for all PIM-SMv6 configured interfaces, use the command:

```
awplus# show ipv6 pim sparse-mode local-members
```

Output Figure 38-6: Example output from the **show ipv6 pim sparse-mode local-members** command

```
awplus#show ipv6 pim sparse-mode local-members
PIM Local membership information

vlan1:

  (*, ff02::1:ff6b:4783) : Include

vlan203:

  (*, ff0e:1::4) : Include
```

Output Figure 38-7: Example output from the **show ipv6 pim sparse-mode local-members vlan1** command

```
awplus#show ipv6 pim sparse-mode local-members vlan1
PIM Local membership information

vlan1:

  (*, ff02::1:ff6b:4783) : Include
```

show ipv6 pim sparse-mode mroute

Overview This command displays the IPv6 multicast routing table, or the IPv6 multicast routing table based on the specified IPv6 address or addresses.

Two group IPv6 addresses cannot be entered simultaneously; two source IPv6 addresses cannot be entered simultaneously.

For information on filtering and saving command output, see the [“Getting_Started with AlliedWare Plus” Feature Overview and Configuration_Guide](#).

Syntax

```
show ipv6 pim sparse-mode mroute
show ipv6 pim sparse-mode mroute <group-IPv6-address>
show ipv6 pim sparse-mode mroute <source-IPv6-address>
show ipv6 pim sparse-mode mroute <group-IPv6-address>
<source-IPv6-address>
show ipv6 pim sparse-mode mroute <source-IPv6-address>
<group-IPv6-address>
show ipv6 pim sparse-mode mroute brief
```

Parameter	Description
<i><group-IPv6-address></i>	Group IPv6 address, entered in the form X:X::X:X. Based on the group and source IPv6 address, the output is the selected route if present in the multicast route tree.
<i><source-IPv6-address></i>	Source IPv6 address, entered in the form X:X::X:X. Based on the source and group IPv6 address, the output is the selected route if present in the multicast route tree.
brief	Brief display

Mode User Exec and Privileged Exec

Usage notes Note that when a feature license is enabled, the output for the [show ipv6 pim sparse-mode mroute](#) command will only show 100 interfaces because of the terminal display width limit. Use the [show ipv6 pim sparse-mode mroute detail](#) command to display detailed entries of the IPv6 multicast routing table.

Examples

```
awplus# show ipv6 pim sparse-mode mroute
awplus# show ipv6 pim sparse-mode mroute 2001:db8::
awplus# show ipv6 pim sparse-mode mroute 2001:db8:: 2002:db8::
awplus# show ipv6 pim sparse-mode mroute brief
```

Figure 38-8: Example output from the **show ipv6 pim sparse-mode mroute** command

```
awplus#show ipv6 pim sparse-mode mroute
IPv6 Multicast Routing Table

(*,*,RP) Entries: 0(*,G) Entries: 0
(S,G) Entries: 2
(S,G,rpt) Entries: 2
FCR Entries: 0(2001:db8:ffff::1, ff08::1)
RPF nbr: fe80::b:10:0:1
RPF idx: vlan10
SPT bit: 1
Upstream State: JOINED
  Local          0
  Joined         1
  Asserted Winner 0
  Asserted Loser  0
  Outgoing       1(2001:db8:ffff::1, ff08::1, rpt)
RP: ::
RPF nbr: fe80::b:10:0:1
RPF idx: vlan10
Upstream State: RPT NOT JOINED
  Local          0
  Pruned         0
  Outgoing       0(2001:db8:ffff::1, ff08::2)
RPF nbr: fe80::b:10:0:1
RPF idx: vlan10
SPT bit: 1
Upstream State: JOINED
  Local          0
  Joined         1
  Asserted Winner 0
  Asserted Loser  0
  Outgoing       1
```

Figure 38-9: Example output from the **show ipv6 pim sparse-mode mroute brief** command

```
awplus#show ipv6 pim sparse-mode mroute brief
IPv6 Multicast Routing Table

(*,*,RP) Entries: 0
(*,G) Entries: 0
(S,G) Entries: 2
(S,G,rpt) Entries: 2
FCR Entries: 0
```

show ipv6 pim sparse-mode mroute detail

Overview This command displays detailed entries of the IPv6 multicast routing table, or detailed entries of the IPv6 multicast routing table based on the specified IPv6 address or addresses.

Two group IPv6 addresses cannot be used simultaneously; two IPv6 source addresses cannot be used simultaneously.

For information on filtering and saving command output, see the [“Getting_Started with AlliedWare Plus” Feature Overview and Configuration_Guide](#).

Syntax `show ipv6 pim sparse-mode mroute [<source-IPv6-address>] detail`

Parameter	Description
<code><source-IPv6-address></code>	Source IPv6 address, entered in the form X:X::X:X. Output is all multicast entries belonging to that source.
<code>detail</code>	Show detailed information.

Usage notes Based on the group and source IPv6 address, the output is the selected route if present in the multicast route tree.

Mode User Exec and Privileged Exec

Examples

```
awplus# show ipv6 pim sparse-mode mroute detail
awplus# show ipv6 pim sparse-mode mroute 2001:db8:: detail
awplus# show ipv6 pim sparse-mode mroute 2001:db8:: 2002:db8::
detail
```

Figure 38-10: Example output from the **show ipv6 pim sparse-mode mroute detail** command

```
awplus#show ipv6 pim sparse-mode mroute detail
IPv6 Multicast Routing Table

(*,*,RP) Entries: 0
(*,G) Entries: 1
(S,G) Entries: 0
(S,G,rpt) Entries: 0
FCR Entries: 0

(*, ff13::10) Uptime: 00:00:09
RP: ::, RPF nbr: None, RPF idx: None
Upstream:
  State: JOINED, SPT Switch: Enabled, JT: off
  Macro state: Join Desired,
Downstream:
  vlan2:
    State: NO INFO, ET: off, PPT: off
    Assert State: NO INFO, AT: off
    Winner: ::, Metric: 42949672951, Pref: 42949672951, RPT bit: on
    Macro state: Could Assert, Assert Track
Local Olist:
  vlan3
FCR:
```

show ipv6 pim sparse-mode neighbor

Overview Use this command to show the PIM-SMv6 neighbor information.

For information on filtering and saving command output, see the [“Getting_Started with AlliedWare Plus” Feature Overview and Configuration_Guide](#).

Syntax `show ipv6 pim sparse-mode neighbor [<interface>]
[<IPv6-address>] [detail]`

Parameter	Description
<interface>	Interface name. Show neighbors on an interface.
<IPv6-address>	Show neighbors with a particular address on an interface. The IPv6 address entered in the form X:X::X:X.
detail	Show detailed information.

Mode User Exec and Privileged Exec

Examples `awplus# show ipv6 pim sparse-mode neighbor`
`awplus# show ipv6 pim sparse-mode neighbor vlan5 detail`

Figure 38-11: Example output from the **show ipv6 pim sparse-mode neighbor** command

```
awplus#show ipv6 pim sparse-mode neighbor
Neighbor Address          Interface    Uptime/Expires          DR
                               Pri/Mode
fe80::202:b3ff:fed4:69fe  vlan2       05:33:52/00:01:41 1 /
fe80::20e:cff:fe01:facc  vlan3       05:33:53/00:01:26 1 / DR
```

Figure 38-12: Example output from the **show ipv6 pim sparse-mode neighbor interface detail** command

```
awplus#show ipv6 pim sparse-mode neighbor detail
Nbr fe80::211:11ff:fe44:4cd8 (vlan1), DR
Expires in 64 seconds, uptime 00:00:53
Holdtime: 70 secs, T-bit: off, Lan delay: 1, Override interval: 3
DR priority: 100, Gen ID: 1080091886,
Secondary addresses:
3ffe:10:10:10:3::180
```

show ipv6 pim sparse-mode nexthop

Overview Use this command to see the next hop information as used by PIM-SMv6.

For information on filtering and saving command output, see the [“Getting_Started with AlliedWare Plus” Feature Overview and Configuration_Guide](#).

Syntax show ipv6 pim sparse-mode nexthop

Mode User Exec and Privileged Exec

Example awplus# show ipv6 pim sparse-mode nexthop

Figure 38-13: Example output from the **show ipv6 pim sparse-mode nexthop** command

```
awplus#show ipv6 pim sparse-mode nexthop
Flags: N = New, R = RP, S = Source, U = Unreachable
Destination          Type  Nexthop Nexthop Nexthop  Nexthop Metric   Pref  Refcnt
                   Num   Addr   Ifindex Name
-----
3ffe:10:10:5::153   .RS.  1      fe80::20e:cff:fe01:facc 2    30   110   1
```

Table 2: Parameters in output of the **show ipv6 pim sparse-mode nexthop** command

Parameter	Description
Destination	The destination address for which PIM-SMv6 requires next hop information.
Type	The type of destination, as indicated by the Flags description. N = New, R= RP, S = Source, U = Unreachable.
Nexthop Num	The number of next hops to the destination. PIM-SMv6 always uses only 1 next hop.
Nexthop Addr	The address of the primary next hop gateway.
Nexthop IfIndex	The interface on which the next hop gateway can be reached.
Nexthop Name	The name of next hop interface.
Metric	The metric of the route towards the destination.
Preference	The preference of the route towards destination.
Refcnt	Only used for debugging.

show ipv6 pim sparse-mode rp-hash

Overview Use this command to display the Rendezvous Point (RP) to be chosen based on the IPv6 group address selected.

For information on filtering and saving command output, see the [“Getting Started with AlliedWare Plus” Feature Overview and Configuration Guide](#).

Syntax `show ipv6 pim sparse-mode rp-hash <IPv6-group-addr>`

Parameter	Description
<code><IPv6-group-addr></code>	The IPv6 group address used to find the RP, entered in the form X:X::X:X.

Mode User Exec and Privileged Exec

Example `awplus# show ipv6 pim sparse-mode rp-hash ff04:10`

Figure 38-14: Output from the **show ipv6 pim sparse-mode rp-hash** command:

```
awplus#show ipv6 pim sparse-mode rp-hash ff04::10
RP: 3ffe:10:10:5::153
Info source: 3ffe:10:10:5::153, via bootstrap
```

Related commands [show ipv6 pim sparse-mode rp mapping](#)

show ipv6 pim sparse-mode rp mapping

Overview Use this command to show group-to-RP (Rendezvous Point) mappings, and the RP set.

For information on filtering and saving command output, see the [“Getting_Started with AlliedWare Plus” Feature Overview and Configuration_Guide](#).

Syntax `show ipv6 pim sparse-mode rp mapping`

Mode User Exec and Privileged Exec

Example `awplus# show ipv6 pim sparse-mode rp mapping`

Figure 38-15: Output from the **show ipv6 pim sparse-mode rp mapping** command

```
awplus#show ipv6 pim sparse-mode rp mapping
PIM Group-to-RP Mappings
Group(s): ff00::/8
  RP: 3ffe:10:10:5::153
    Info source: 3ffe:10:10:5::153, via bootstrap, priority 192
    Uptime: 05:36:40
```

Related commands [show ipv6 pim sparse-mode rp-hash](#)

show ipv6 pim sparse-mode rp nexthop

Overview Use this command to display the RP (Rendezvous Point) next hop information used by PIM-SMv6.

For information on filtering and saving command output, see the [“Getting Started with AlliedWare Plus” Feature Overview and Configuration Guide](#).

Syntax `show ipv6 pim sparse-mode rp nexthop <RP-group-addr>`

Parameter	Description
<code><RP-group-addr></code>	Specify the RP group address used to display next hop RP information, entered in the form X:X::X:X.

Mode User Exec and Privileged Exec

Example `awplus# show ipv6 pim sparse-mode rp nexthop 3ffe:10:10:5::153`

Figure 38-16: Example output from the **show ipv6 pim sparse-mode rp nexthop** command

```
awplus#show ipv6 pim sparse-mode rp nexthop 3ffe:10:10:5::153
Flags: N = New, R = RP, S = Source, U = Unreachable
Destination          Type  Nexthop Nexthop Nexthop  Nexthop Metric   Pref  Refcnt
                   Num   Addr    Ifindex Name
-----
3ffe:10:10:5::153   .RS.  1       fe80::20e:cff:fe01:facc 2    30   110   1
```

Table 3: Parameters in output of the **show ipv6 pim sparse-mode rp nexthop** command

Parameter	Description
Destination	The destination address for which PIM-SMv6 requires next hop information.
Type	The type of destination, as indicated by the Flags description. N = New, R= RP, S = Source, U = Unreachable.
Nexthop Num	The number of next hops to the destination. PIM-SMv6 always uses only 1 next hop.
Nexthop Addr	The address of the primary next hop gateway.
Nexthop IfIndex	The interface on which the next hop gateway can be reached.
Nexthop Name	The name of next hop interface.

Table 3: Parameters in output of the **show ipv6 pim sparse-mode rp nexthop** command (cont.)

Parameter	Description
Metric	The metric of the route towards the destination.
Preference	The preference of the route towards destination.
Refcnt	Only used for debugging.

undebbug all ipv6 pim sparse-mode

Overview Use this command to disable all PIM-SMv6 debugging.

Syntax `undebbug all ipv6 pim sparse-mode`

Mode Privileged Exec

Example `awplus# undebbug all ipv6 pim sparse-mode`

Related commands [debug ipv6 pim sparse-mode](#)

undebbug ipv6 pim sparse-mode

Overview Use this command to deactivate PIM-SMv6 debugging. Note that this command is an alias of the no variant of the [debug ipv6 pim sparse-mode](#) command.

Syntax `undebbug ipv6 pim sparse-mode [all] [events] [mfc] [mib] [nexthop] [nsm] [state] [timer]`

Parameter	Description
all	Deactivates all PIM-SMv6 debugging.
events	Deactivates debug printing of PIM-SMv6 events.
mfc	Deactivates debug printing of MFC (Multicast Forwarding Cache).
mib	Deactivates debug printing of PIM-SMv6 MIBs.
nexthop	Deactivates debug printing of PIM-SMv6 next hop communications.
nsm	Deactivates debugging of PIM-SMv6 NSM (Network Services Module) communications.
state	Deactivates debug printing of state transition on all PIM-SMv6 FSMs.
timer	Deactivates debug printing of PIM-SMv6 timers.

Mode Privileged Exec and Global Configuration

Example

```
awplus# configure terminal
awplus(config)# terminal monitor
awplus(config)# undebbug ipv6 pim sparse-mode all
awplus# configure terminal
awplus(config)# terminal monitor
awplus(config)# undebbug ipv6 pim sparse-mode events
awplus# configure terminal
awplus(config)# terminal monitor
awplus(config)# undebbug ipv6 pim sparse-mode nexthop
```

Validation Output Figure 38-17: Example output from the **show debugging ipv6 pim sparse-mode** command after issuing the **undebug ipv6 pim sparse-mode all** command

```
awplus#undebug ipv6 pim sparse-mode all
awplus#show debugging ipv6 pim sparse-mode
PIM-SMv6 debugging status:
  PIM event debugging is off
  PIM MFC debugging is off
  PIM state debugging is off
  PIM packet debugging is off
  PIM Hello HT timer debugging is off
  PIM Hello NLT timer debugging is off
  PIM Hello THT timer debugging is off
  PIM Join/Prune JT timer debugging is off
  PIM Join/Prune ET timer debugging is off
  PIM Join/Prune PPT timer debugging is off
  PIM Join/Prune KAT timer debugging is off
  PIM Join/Prune OT timer debugging is off
  PIM Assert AT timer debugging is off
  PIM Register RST timer debugging is off
  PIM Bootstrap BST timer debugging is off
  PIM Bootstrap CRP timer debugging is off
  PIM mib debugging is off
  PIM nsm debugging is off
  PIM nexthop debugging is off
```

Related commands

- [debug ipv6 pim sparse-mode](#)
- [show debugging ipv6 pim sparse-mode](#)
- [undebug all ipv6 pim sparse-mode](#)

Part 5: Access and Security

39

Traffic Control Commands

Introduction

Overview This chapter provides an alphabetical reference of commands used to configure traffic control. For more information, see the [Traffic Control Feature Overview and Configuration Guide](#).

- Command List**
- “[class \(htb\)](#)” on page 2022
 - “[class \(priority\)](#)” on page 2024
 - “[class \(wrr\)](#)” on page 2026
 - “[debug traffic-control](#)” on page 2028
 - “[interface \(traffic-control\)](#)” on page 2029
 - “[interface dynamic-virtual-bandwidth](#)” on page 2031
 - “[l3-filtering enable](#)” on page 2033
 - “[move rule \(traffic-control\)](#)” on page 2034
 - “[policy \(traffic-control\)](#)” on page 2035
 - “[red-curve](#)” on page 2037
 - “[rule \(traffic-control\)](#)” on page 2039
 - “[show debugging traffic-control](#)” on page 2041
 - “[show running-config traffic-control](#)” on page 2042
 - “[show traffic-control counters](#)” on page 2044
 - “[show traffic-control interface](#)” on page 2046
 - “[show traffic-control policy](#)” on page 2048
 - “[show traffic-control red-curve](#)” on page 2050
 - “[show traffic-control rule config-check](#)” on page 2052
 - “[show traffic-control rule](#)” on page 2053

- [“show traffic-control”](#) on page 2054
- [“sub-class \(htb\)”](#) on page 2055
- [“sub-class \(priority\)”](#) on page 2057
- [“sub-class \(wrr\)”](#) on page 2059
- [“sub-sub-class \(htb\)”](#) on page 2061
- [“sub-sub-class \(priority\)”](#) on page 2063
- [“sub-sub-class \(wrr\)”](#) on page 2065
- [“traffic-control enable”](#) on page 2067
- [“traffic-control”](#) on page 2068

class (htb)

Overview Use this command to configure a hierarchy token bucket (HTB) class within a traffic control policy.

Use the **no** variant of this command to delete an existing class under a current policy.

Syntax `class <class-name> [cir <committed-rate>] [pir <peak-rate>]
[bc <1-100000000>] [be <1-100000000>] [preference <0-7>]
[queue-length <2-65536>] [set-dscp <dscp-value>] [red-curve
<red-curve-name>]`

`class <class-name> [cir <committed-rate>] [pir <peak-rate>]
[bc <1-100000000>] [be <1-100000000>] [preference <0-7>]
sub-class-policy htb`

`no class <class-name>`

Parameter	Description
<code><class-name></code>	Name of the class.
<code>cir <committed-rate></code>	Set the Committed Information Rate (CIR) for the queue. This parameter is compulsory when creating a new class. When editing an existing class, this parameter is optional.
<code>pir <peak-rate></code>	Set the Peak Information Rate (PIR) for the queue. This is the rate of the queue under peak conditions. Specified in kbit/mbit/gbit per second, in the range 1kbit-100gbit.
<code>bc <1-100000000></code>	Set the Committed Burst size (BC). This is the burst allowed above the CIR sent at the PIR rate.
<code>be <1-100000000></code>	Set the Excess Burst size (BE). This is the burst allowed above the PIR sent at the maximum rate.
<code>preference <0-7></code>	Set the preference for a class to receive spare bandwidth. Preference for the class to receive spare bandwidth (highest is 7).
<code>queue-length <2-65536></code>	Set the maximum queue length.
<code>set-dscp <dscp-value></code>	Set the DSCP value to apply to the packets.
<code>red-curve <red-curve-name></code>	Apply a random early discard template with the class (only available on leaf queues when specifying class policy). If the keyword <code><default></code> is used then the default RED curve is applied.
<code>sub-class-policy</code>	Specify that the class will contain sub-classes.
<code>htb</code>	Sub-classes will use the Hierarchy Token Bucket (HTB) queueing discipline.

Default BC and BE are assigned suitable values proportional to the CIR and PIR respectively, and are larger than the MTU. The PIR defaults to the CIR. The Preference defaults to 7 and the queue-length defaults to 1000 (if the class is a leaf). If the keyword `<default>` is used then the default RED curve is applied.

Mode Traffic-Control Policy for an HTB policy.

Usage If there is already a class in the same level that has the specified name, the command will replace the configuration of the existing class if it does not have any sub-classes.

If a sub-class policy is specified, this command uses the Traffic-Control Class mode to apply it.

Examples To configure a leaf class, use the commands:

```
awplus#configure terminal
awplus (config) #traffic-control
awplus (config-tc) #policy p01 htb
awplus (config-tc-policy) #class c01 cir 100mbit pir 150mbit
```

To configure a class with a sub-sub-class as the leaf class, use the commands:

```
awplus#configure terminal
awplus (config) #traffic-control
awplus (config-tc) #policy p01 htb
awplus (config-tc-policy) #class c01 cir 100mbit pir 150mbit
sub-class-policy htb

awplus (config-tc-class) #sub-class s01 cir 10mbit sub-sub-class
policy htb

awplus (config-tc-subclass) #sub-sub-class ss01 cir 5mbit
queue-length 200 red-curve ss01-red
```

To enter Traffic-Control Class mode for an existing class, use the commands:

```
awplus#configure terminal
awplus (config) #traffic-control
awplus (config-tc) #policy p01
awplus (config-tc-policy) #class c01
awplus (config-tc-class) #
```

To delete an existing class, use the commands:

```
awplus#configure terminal
awplus (config) #traffic-control
awplus (config-tc) #policy p01
awplus (config-tc-policy) #no class c01
```

Related commands

- [policy \(traffic-control\)](#)
- [sub-class \(htb\)](#)
- [traffic-control](#)

class (priority)

Overview Use this command to configure a priority queue class within a traffic control policy.

Use the **no** variant of this command to delete an existing priority class under a current policy.

Syntax `class <class-name> [priority-level <0-15>] [max <max-rate>]
[queue-length <2-65536>] [set-dscp <dscp-value>] [red-curve
<red-curve-name>]`

`class <class-name> [priority-level <0-15>] sub-class-policy
{priority|wrr|htb}`

`no class <class-name>`

Parameter	Description
<code><class-name></code>	Name of the class.
<code>priority-level <0-15></code>	Set the priority level (15 is the highest). This parameter is compulsory when creating a new class. When editing an existing class, this parameter is optional.
<code>max <max-rate></code>	Set the maximum traffic rate of the queue (in kbit/mbit/gbit per second, 1kbit-100gbit).
<code>queue-length <2-65535></code>	Set the maximum queue length in packets (only available on leaf queues when specifying sub-class policy).
<code>set-dscp <dscp-value></code>	Set the DSCP value to apply to the packets (only available on leaf queues when specifying sub-class policy).
<code>red-curve <red-curve-name></code>	Apply a random early discard template with the class (only available on leaf queues when specifying class policy). If the keyword <code><default></code> is used then the default RED curve is applied.
<code>sub-class-policy</code>	Create a sub-class within the policy.
<code>priority</code>	Sub-classes use the Priority Queue scheduling algorithm.
<code>wrr</code>	Sub-classes use the Weighted Round Robin scheduling algorithm.
<code>htb</code>	Sub-classes use the Hierarchy Token Bucket scheduling algorithm.

Default No priority class is applied. If the keyword `<default>` is used then the default RED curve is applied.

Mode Traffic Control Policy for a priority policy.

Usage If there is already a class in the same level with the specified name, the command will replace the configuration of the existing class if it does not have any sub-classes.

If a sub-class policy is specified, this command uses the Traffic-Control Class mode to apply it.

Examples To configure a leaf class, use the commands:

```
awplus#configure terminal
awplus (config) #traffic-control
awplus (config-tc) #policy p01 priority
awplus (config-tc-policy) #class c01 priority-level 5
```

To configure a class with a sub-sub-class as the leaf class, use the commands:

```
awplus#configure terminal
awplus (config) #traffic-control
awplus (config-tc) #policy p01 priority
awplus (config-tc-policy) #class c01 priority-level 5
sub-class-policy priority
awplus (config-tc-class) #sub-class s01 priority-level 7
sub-sub-class-policy priority
awplus (config-tc-subclass) #sub-sub-class ss01 priority-level 3
max 5mbit queue-length 200 red-curve ss01-red
```

To enter Traffic-Control Class mode for an existing class, use the commands:

```
awplus#configure terminal
awplus (config) #traffic-control
awplus (config-tc) #policy p01
awplus (config-tc-policy) #class c01
awplus (config-tc-class) #
```

To delete an existing policy class, use the commands:

```
awplus#configure terminal
awplus (config) #traffic-control
awplus (config-tc) #policy p01
awplus (config-tc-policy) #no class c01
```

Related commands

- [policy \(traffic-control\)](#)
- [sub-class \(htb\)](#)
- [sub-class \(wrr\)](#)
- [traffic-control](#)

class (wrr)

Overview Use this command to configure a Weighted Round-Robin (WRR) class within a traffic control policy.

Use the **no** variant of this command to delete an existing class under a current policy.

Syntax `class <class-name> [weight <1-100>] [queue-length <2-65536>]
[set-dscp <dscp-value>] [red-curve <red-curve-name>]
class <class-name> [weight <1-100>] sub-class-policy wrr
no class <class-name>`

Parameter	Description
<code><class-name></code>	Name of the class.
<code>weight <1-100></code>	Set the weight. The relative weight is the available bandwidth divided between sibling WRR classes according to the ratio of their configured weights. This parameter is compulsory when creating a new class. When editing an existing class, this parameter is optional.
<code>queue-length <2-65536></code>	Set the maximum queue length in packets.
<code>set-dscp <dscp-value></code>	Set the DSCP value to apply to packets.
<code>red-curve <red-curve-name></code>	Apply a random early discard template with the class (only available on leaf queues when specifying class policy). If the keyword <code><default></code> is used then the default RED curve is applied.
<code>sub-class-policy</code>	Create a sub-class within the policy.
<code>wrr</code>	Sub-classes use the Weighted Round Robin queueing algorithm.

Default A weighted round-robin class has no DSCP value or sub-class policy. The queue length is 1000 by default. If the keyword `<default>` is used then the default RED curve is applied.

Mode Traffic-Control Policy for a WRR policy.

Usage If there is already a class in the same level with the specified name, the command will replace the configuration of the existing class if it does not have any sub-classes.

If a sub-class policy is specified, this command uses the Traffic-Control Class mode to apply it.

Examples To configure a leaf class, use the commands:

```
awplus#configure terminal
awplus(config)#traffic-control
awplus(config-tc)#policy p01 wrr
awplus(config-tc-policy)#class c01 weight 50
```

To configure a class with a sub-sub-class as the leaf class, use the commands:

```
awplus#configure terminal
awplus(config)#traffic-control
awplus(config-tc)#policy p01 wrr
awplus(config-tc-policy)#class c01 weight 50 sub-class-policy
wrr
awplus(config-tc-class)#sub-class s01 weight 30 sub-sub-class-
policy wrr
awplus(config-tc-subclass)#sub-sub-class ss01 weight 5
queue-length 200 red-curve ss01-red
```

To enter Traffic-Control Class mode for an existing class, use the commands:

```
awplus#configure terminal
awplus(config)#traffic-control
awplus(config-tc)#policy p01
awplus(config-tc-policy)#class c01
awplus(config-tc-class)#
```

To delete an existing class, use the commands:

```
awplus#configure terminal
awplus(config)#traffic-control
awplus(config-tc)#policy p01
awplus(config-tc-policy)#no class c01
```

Related commands [traffic-control](#)
[policy \(traffic-control\)](#)
[sub-class \(wrr\)](#)

debug traffic-control

Overview Use this command to enable traffic-control debugging. This will cause additional detailed debugging information to be logged and available using the show debugging traffic-control.

Use the **no** variant of this command to disable traffic-control debugging.

Syntax debug traffic-control
no debug traffic-control

Default Disabled

Mode Privileged Exec

Examples To enable traffic control debugging, use the commands:

```
awplus#debug traffic-control
```

To disable traffic control debugging, use the commands:

```
awplus#no debug traffic-control
```

Related commands traffic-control
show debugging traffic-control

interface (traffic-control)

Overview Use this command to configure interface specific parameters for traffic control.

Syntax `interface <interface-name> {overhead
[<overhead-bytes>|ethernet]|virtual-bandwidth
<bandwidth>|system-bandwidth <system-percentage>}`

Parameter	Description
<interface-name>	Name of interface to configure
overhead	Set overhead to add to each packet when calculating the packet size
<overhead-bytes>	Number of bytes to add to the packet for packet size calculations. The range is from 0 to 512 and the default is 0.
ethernet	Setting the overhead to 'ethernet' adds 24 bytes to the packet to account for preamble + CRC + inter-frame gap.
virtual-bandwidth	Specify the virtual-bandwidth of the interface. This is the maximum amount of traffic that traffic control will allow to be sent via the interface..
<bandwidth>	Value for the virtual bandwidth in kbit, mbit or gbits (for example, 5mbit).
system-bandwidth	Specify the percentage of the interface bandwidth to reserve for system traffic. The default when a traffic control policy is applied to the interface is 5%.
<system-percentage>	Percentage of the bandwidth to reserve for system traffic in the range from 1 to 99.

Default The default overhead is 0, the default bandwidth is the interface speed if it can be read. It is recommended to always set the virtual bandwidth when using traffic control. The system bandwidth default is 5%.

Mode Traffic-Control

Usage This command allows configuring traffic control parameters specific to the traffic egress interface.

Note that if you use Vista Manager EX's Auto Traffic Shaping feature, it will dynamically set the virtual bandwidth. In that situation, if you use this command to set the virtual bandwidth, your setting will only apply until Vista Manager EX dynamically overrides it. Your setting also won't be saved in the running config.

See the [interface dynamic-virtual-bandwidth](#) command for more information about the virtual bandwidth when using Auto Traffic Shaping.

Examples To rate limit eth1 to 10mbit while taking into account the ethernet framing overhead and reserving only 1% of the bandwidth for system traffic, use the commands:

```
awplus#configure terminal
awplus(config)#traffic-control
awplus(config-tc)#interface eth1 overhead ethernet
virtual-bandwidth 10mbit system-bandwidth 1
```

Related commands

- [interface dynamic-virtual-bandwidth](#)
- [show running-config traffic-control](#)
- [show traffic-control interface](#)

Command changes Version 5.5.0-1.1: behavior changed when Auto Traffic Shaping is enabled in Vista Manager EX

interface dynamic-virtual-bandwidth

Overview Use this command to set or change the 'initial' virtual bandwidth value when Vista Manager EX has control of the virtual bandwidth on an interface. Vista Manager EX controls virtual bandwidth as part of Auto Traffic Shaping (ATS).

The device will use this command's virtual bandwidth in two situations:

- If you reboot the device, the device uses this virtual bandwidth until Vista Manager EX takes over control of the bandwidth
- It becomes the interface's virtual bandwidth if you turn off Auto Traffic Shaping in Vista Manager EX.

When Auto Traffic Shaping is on, the device does not store the interface's virtual-bandwidth in the device's running-config. This is to prevent Vista Manager EX's dynamic virtual bandwidth values from becoming permanent values.

Use the **no** variant of this command to indicate that Vista Manager EX no longer controls virtual bandwidth on this interface. Using the **no** variant does not change the current virtual-bandwidth value for the interface. If the current virtual-bandwidth value is not the default value, it will display in the device's running-config.

Syntax `interface <tunnel-name> dynamic-virtual-bandwidth controller <name> [initial-bandwidth <bandwidth>]`
`no interface <interface-name> dynamic-virtual-bandwidth`

Parameter	Description
<code><tunnel-name></code>	Name of the tunnel to configure
<code>controller <name></code>	An identifier for the controller that is controlling the bandwidth. When Vista Manager EX is the controller, it will automatically set this value to 'vista-dynamic-management'. The name may contain alphanumeric, hyphen, underscore, comma, space or square brace characters, with a limit of 64 characters.
<code>initial-bandwidth <bandwidth></code>	The value to apply as the interface's virtual-bandwidth when the interface starts up and if you turn ATS off. This value is the maximum amount of traffic that traffic control will allow the device to send via the interface (until the external manager changes it). Specify the value in kbit, mbit or gbits (for example, 5mbit).

Default If you turn on ATS in Vista Manager EX and do not use this command to set the initial bandwidth, then the device uses the virtual-bandwidth value from the command [interface \(traffic-control\)](#).

Mode Traffic-Control

Examples To set an initial virtual-bandwidth of 10Mbps on tunnel2 when using Auto Traffic Shaping on Vista Manager EX, use the commands:

```
awplus#configure terminal
awplus(config)#traffic-control
awplus(config-tc)#interface tunnel2 dynamic-virtual-bandwidth
controller vista-dynamic-management initial-bandwidth 10mbit
```

Related commands [traffic-control](#)
[show running-config traffic-control](#)
[show traffic-control interface](#)

Command changes Version 5.5.0-1.1: command added

I3-filtering enable

Overview Use this command to enable traffic control for bridged traffic on a bridge interface.

Use the **no** variant of this command to disable traffic control for bridged traffic on a bridge interface.

Syntax l3-filtering enable
no l3-filtering enable

Default Traffic control is disabled by default for bridged traffic.

Mode Interface mode for a bridge interface

Example To enable traffic control for bridged traffic on br1, use the commands:

```
awplus# configure terminal
awplus(config)# interface br1
awplus(config-if)# l3-filtering enable
```

Related commands [traffic-control](#)

Command changes Version 5.4.7-0.1: command added. Previously, traffic control was enabled by default on all bridge interfaces.

move rule (traffic-control)

Overview Use this command to change the identification of an existing traffic control rule.

Syntax `move rule [<1-65535> to <1-65535>]`

Parameter	Description
<1-65535>	Range of the rule ID to move from
<1-65535>	Range of the destination ID for the rule to move to

Default None

Mode Traffic-Control

Example To change rule ID 10 to rule ID 25, use the commands:

```
awplus#configure terminal
awplus(config)#traffic-control
awplus(config-tc)#move rule 10 to 25
```

Related commands

- [rule \(traffic-control\)](#)
- [traffic-control](#)
- [show traffic-control](#)
- [show traffic-control rule](#)
- [show traffic-control rule config-check](#)

policy (traffic-control)

Overview Use this command to configure a traffic control policy, that can then be used with rules that have been created.

Use the **no** variant of this command to delete an existing policy.

Syntax `policy <policy-name> [priority|wrr|htb]`
`no policy <policy-name>`

Parameter	Description
<code><policy_name></code>	The name of the policy
<code>priority</code>	Use Priority Queueing (PQ)
<code>wrr</code>	Use Weighted Round Robin (WRR)
<code>htb</code>	Use Hierarchy Token Bucket (HTB)

Default No policies are configured

Mode Traffic-Control

Usage A policy specifies a top-level queueing discipline which determines the type of classes that can be configured under the policy. This command uses the Traffic-Control Policy mode.

Examples To configure a policy, use the commands:

```
awplus#configure terminal
awplus(config)#traffic-control
awplus(config-tc)#policy p01 htb
awplus(config-tc-policy)#
```

To delete an existing policy, use the commands:

```
awplus#configure terminal
awplus(config)#traffic-control
awplus(config-tc)#no policy p01 htb
```

Related commands

- [class \(htb\)](#)
- [class \(priority\)](#)
- [class \(wrr\)](#)
- [rule \(traffic-control\)](#)
- [traffic-control](#)
- [sub-class \(htb\)](#)

sub-class (priority)

sub-class (wrr)

sub-sub-class (htb)

sub-sub-class (priority)

sub-sub-class (wrr)

red-curve

Overview Use this command to allow configuration of a RED (Random Early Discard) curve template.

Use the **no** variant of this command to set the RED curve back to the default.

Syntax `red-curve <red-curve-name> [limit <4-127>] [avpkt <64-1518>]
[min <3-126>] [max <4-127>] [probability <1-100>]
[ecn [ecn-drop]]
no red-curve [<red-curve-name>]`

Parameter	Description
<code><red-curve-name></code>	The RED curve name.
<code>limit <4-127></code>	The hard queue length limit (in packets) for the RED curve. Once the queue length reaches the limit, all packets are dropped.
<code>avpkt <64-1518></code>	The average packet size to use for queue size calculations in bytes.
<code>min <3-126></code>	The minimum queue length for random early discard (in packets). Between <code><min></code> and <code><max></code> the drop probability will increase linearly.
<code>max <4-127></code>	The maximum queue length where packets are probabilistically dropped. At <code><max></code> the drop probability equals <code><probability></code> . Beyond <code><max></code> the drop or marking probability is 100%.
<code>probability <1-100></code>	The probability of a packet being dropped when queue-length reaches <code><max></code> . The drop probability increases linearly from 0 to <code><probability></code> in between <code><min></code> and <code><max></code> .
<code>ecn</code>	Use explicit congestion notification marking instead of dropping the packet.
<code>ecn-drop</code>	When average queue size exceeds <code><max></code> drop packets instead of marking.

Default The default RED curve is **red-curve default limit 127 avpkt 576B min 10 max 32 prob 2**.

Mode Traffic-control

Usage notes The RED curve template can later be applied to a traffic control class, sub-class, or sub-sub-class.

Example To configure a RED curve with ECN dropping and the default curve shape, use the commands:

```
awplus# configure terminal
awplus(config)# traffic-control
awplus(config-tc)# red-curve red-ecn ecn
```

To configure an aggressive RED curve, use the commands:

```
awplus# configure terminal
awplus(config)# traffic-control
awplus(config-tc)# red-curve aggressive min 5 max 50
probability 70
```

**Related
commands**

- class (htb)
- class (priority)
- class (wrr)
- show traffic-control policy
- show running-config traffic-control
- show traffic-control red-curve
- sub-class (htb)
- sub-class (priority)
- sub-class (wrr)
- sub-sub-class (htb)
- sub-sub-class (priority)
- sub-sub-class (wrr)

rule (traffic-control)

Overview Use this command to create a traffic-control rule.

Use the **no** variant of this command to remove a traffic-control rule

Syntax `rule [<1-65535>] match <application> from <source-entity> to <destination-entity> policy <policy>`
`no rule [<1-65535>]`

Parameter	Description
<1-65535>	The rule ID is an integer in the range from 1 to 65535. If you do not designate a rule ID, one will be automatically generated and it will be greater than the current highest rule ID. Lower IDs have higher priority.
match	Application traffic to match
<application>	Application name. You can use the tab key to auto-complete application names.
from	Set the source of the entity
<source_entity>	Source entity name. Entities represent logical grouping of subnets, hosts or interfaces. You can use the tab key to auto-complete entity names.
to	Set the destination of the entity
<destination_entity>	Source entity name. Entities represent logical grouping of subnets, hosts or interfaces.
policy	Policy to apply to matched traffic
<policy>	Traffic control policy. This consists of a top-level policy name followed by the name of a class within that policy, and sub-class (of the class) and a sub-sub-class if applicable. Examples are: p01.c03 p01.c03.sc02 p01.c03.scc02.ssc01 In these examples, p01 is the policy name, c03 is the class name, sc02 is the sub-class, and ssc01 is the sub-sub-class.

Default No rules

Mode Traffic-Control

Usage Rules are used to apply traffic-control policies to a type of traffic. When traffic control is enabled and no rules are added, a default traffic-control policy is installed on all supported interfaces.

If the application, source entity or destination entity specified in the rule is not configured correctly, the rule is not valid and is not installed.

You can change the rule order by using the `move rule (traffic-control)` command.

Rules are applied to destination interfaces in the order of their ID (lower IDs are applied first). If traffic matches a rule, then the rest are ignored. If traffic does not match any rule, then it is classified to the default class.

A rule can specify the system class as the policy. System traffic is high priority traffic that is allocated a fixed amount of bandwidth on an interface. Use the interface (traffic-control) command to configure system bandwidth on an interface.

Examples To configure a rule, use the commands:

```
awplus#configure terminal
awplus(config)#traffic-control
awplus(config-tc)#rule 10 match ftp from wan to private policy
p01.c02.sc03
```

To delete a rule, use the commands:

```
awplus#configure terminal
awplus(config)#traffic-control
awplus(config-tc)#no rule 10
```

**Related
commands**

[interface \(traffic-control\)](#)

[move rule \(traffic-control\)](#)

[policy \(traffic-control\)](#)

[traffic-control](#)

[show running-config traffic-control](#)

[show traffic-control rule](#)

show debugging traffic-control

Overview Use this command to display the status of traffic control debugging

Syntax `show debugging traffic-control`

Default None

Mode Privileged Exec

Example To show if traffic-control debugging is on or off, run the command:

```
awplus#show debugging traffic-control
```

Output Figure 39-1: Example output from **show debugging traffic-control**

```
awplus#show debugging traffic-control  
Traffic-control Debugging Status: off
```

Related commands [debug traffic-control](#)
[show debugging](#)

show running-config traffic-control

Overview Use this command to display the current traffic control configuration.

Note that Vista Manager EX will dynamically set the virtual bandwidth if you use its Auto Traffic Shaping feature. In that situation, this command will display the [interface dynamic-virtual-bandwidth](#) command instead of any virtual bandwidth added with the [interface \(traffic-control\)](#) command.

Syntax `show running-config traffic-control`

Default None

Mode Privileged Exec

Example To show the traffic control configuration section of the running configuration, use the command:

```
awplus#show running-config traffic-control
```

Output Figure 39-2: Example output from **show running-config traffic-control**

```
awplus#show running-config traffic-control
traffic-control
policy A wrr
  class B5001 weight 30
  class B5002 weight 60
policy P priority
  class P10 priority-level 10 max 5mbit
  class P3 priority-level 3 max 8mbit sub-class-policy htb
    sub-class H cir 3mbit bc 100000
    sub-class I cir 5mbit bc 100000
  class P2 priority-level 2
policy token-bucket htb
  class A cir 5mbit pir 6mbit preference 2
  class B cir 2mbit pir 4mbit bc 100000 be 100000 preference 3 sub-class-policy htb
    sub-class C cir 1mbit pir 4mbit bc 50000
    sub-class D cir 1mbit pir 4mbit bc 50000 sub-sub-class-policy htb
      sub-sub-class E cir 500kbit pir 4mbit bc 50000 set-dscp af23
      sub-sub-class F cir 500kbit pir 4mbit bc 50000 set-dscp af31
rule 10 match udp-5001 from ipv6.vlan3 to ipv6.eth2 policy A.B5001
rule 20 match udp-5002 from ipv6.vlan3 to ipv6.eth2 policy A.B5002
rule 30 match udp-5001 from main.vlan to main.wan policy A.B5001
rule 40 match udp-5002 from main.vlan to main.wan policy A.B5002
rule 50 match udp-5002 from main.vlan to main.eth1 policy A.B5002
interface eth2 virtual-bandwidth 2mbit overhead ethernet
traffic-control enable
```

Related commands

- [interface \(traffic-control\)](#)
- [show running-config](#)
- [show traffic-control counters](#)
- [show traffic-control interface](#)

show traffic-control policy
show traffic-control rule
show traffic-control rule config-check
traffic-control

Command changes Version 5.5.0-1.1: behavior changed when Auto Traffic Shaping is enabled in Vista Manager EX

show traffic-control counters

Overview Use this command to display counters related to traffic control. This command displays counters for the number of packets sent, queued or dropped by each traffic control class. The information is shown by each interface. There is an overall counter for the policy, and counters for each leaf class in the policy.

If no interface name is specified then information for all interfaces with traffic control policies applied is displayed.

Syntax `show traffic-control counters [<interface-name>]`

Parameter	Description
<code><interface-name></code>	Name of Interface to display traffic control counters

Default None

Mode Privileged Exec

Examples To show the traffic control counters for all interfaces, use the commands:

```
awplus#show traffic-control counters
```

Figure 39-3: Example output from **show traffic-control counters**

```
awplus#show traffic-control counters
Traffic Control Counters
Interface eth1:
Class          Counter          Bytes          Packets
-----
A              Sent              0              0
              Currently Queued  0              0
              Dropped          0              0
A.B5001        Sent              0              0
              Currently Queued  0              0
              Dropped          0              0
A.B5002        Sent              0              0
              Currently Queued  0              0
              Dropped          0              0
A.default      Sent              0              0
              Currently Queued  0              0
              Dropped          0              0
system         Sent              0              0
              Currently Queued  0              0
              Dropped          0              0
```

Interface eth2:			
Class	Counter	Bytes	Packets
A	Sent	58681224	232862
	Currently Queued	0	383
	Dropped		1039845
A.B5001	Sent	10671444	42347
	Currently Queued	32004	128
	Dropped		164954
A.B5002	Sent	17661924	70087
	Currently Queued	32004	127
	Dropped		123470
A.default	Sent	30348360	120430
	Currently Queued	32004	128
	Dropped		751421
system	Sent	42	1
	Currently Queued	0	0
	Dropped		0

Related commands [show running-config traffic-control](#)

show traffic-control interface

Overview Use this command to display information about interfaces known to traffic control, such as the applied policy, the virtual-bandwidth configured on the interface, the bandwidth reserved for system traffic and the overhead applied to the packet size calculations. If no interface name is specified, information is shown for all interfaces known to traffic control.

Syntax `show traffic-control interface [<interface-name>]`

Parameter	Description
<code><interface-name></code>	Name of interface to display information

Default None

Mode Privileged Exec

Examples To show traffic control information for all interfaces, use the command:

```
awplus#show traffic-control interface
```

Output Figure 39-4: Example output from **show traffic-control interface**

```
awplus#show traffic-control interface
Traffic Control Interface Information

eth1:

Policy:                A
Virtual bandwidth:    Not set (optional)
System bandwidth:     5%
Packet overhead:      0 Bytes

eth2:

Policy:                A
Virtual bandwidth:    2000 kbit
System bandwidth:     5%
Packet overhead       24 Bytes (Ethernet transport layer)

vlan1:

Policy:                Default policy
Virtual bandwidth:    Not set (optional)
Packet overhead:      0 Bytes
```

```
vlan10:
Policy:           Default policy
Virtual bandwidth: Not set (optional)
Packet overhead:  0 Bytes

vlan3:
Policy:           Default policy
Virtual bandwidth: Not set (optional)
Packet overhead:  0 Bytes

vlan4:
Policy:           Default policy
Virtual bandwidth: Not set (optional)
Packet overhead:  0 Bytes

vlan666:
Policy:           Default policy
Virtual bandwidth: Not set (optional)
Packet overhead:  0 Bytes
```

Related commands [interface \(traffic-control\)](#)
[show running-config traffic-control](#)

show traffic-control policy

Overview Use this command to show information about the configured traffic control policies and classes. This command shows the configured traffic control policies and the interfaces that they are applied to. Only non-default configuration parameters are shown.

If no policy name is given, all configured policies are displayed.

Syntax `show traffic-control policy [<policy-name>]`

Parameter	Description
<code><policy-name></code>	Name of policy to display

Default None

Mode Privileged Exec

Examples To show all traffic control policies, use the command:

```
awplus#show traffic-control policy
```

Output Figure 39-5: Example output from **show traffic-control policy**

```
awplus#show traffic-control policy
Traffic Control Policies:
Policy A:
  Type:                wrd
  Applied interfaces:  eth1 eth2
  Classes:
    Class B5001:
      Weight:          30
    Class B5002:
      Weight:          60
      Red curve:      default
Policy P:
  Type:                priority
  Applied interfaces:  None
  Classes:
    Class P10:
      Priority:        10
      Peak rate (PIR): 5000kbit
    Class P3:
      Priority:        3
      Peak rate (PIR): 8000kbit
      Sub-queue type:  htb
      Red curve       TCP_session_1
```

```
Class H:
  Committed rate (CIR): 3000kbit
  Burst (Bc): 100000B
Class I:
  Committed rate (CIR): 5000kbit
  Burst (Bc): 100000B
Class P2:
  Priority: 2
  Red curve: TCP_session_2
Policy token-bucket:
  Type: htb
  Applied interfaces: None
Classes:
  Class A:
    Committed rate (CIR): 5000kbit
    Peak rate (PIR): 6000kbit
    Preference: 2
  Class B:
    Committed rate (CIR): 2000kbit
    Peak rate (PIR): 4000kbit
    Burst (Bc): 100000B
    Excess Burst (Be): 100000B
    Preference: 3
    Sub-queue type: htb
  Class C:
    Committed rate (CIR): 2000kbit
    Peak rate (PIR): 4000kbit
    Burst (BC): 50000B
  Class D:
    Committed rate (CIR): 1000kbit
    Peak rate (PIR): 4000kbit
    Burst (Bc): 50000B
    Sub-queue type: htb
  Class E:
    Committed rate (CIR): 500kbit
    Peak rate (PIR): 4000kbit
    Burst (Bc): 50000B
    Set DSCP: af23
  Class F:
    Committed rate (CIR): 500kbit
    Peak rate (PIR): 4000kbit
    Burst (Bc): 50000B
    Set DSCP: af31
```

Related commands [show running-config](#)
[show running-config traffic-control](#)

show traffic-control red-curve

Overview Use this command to show configured RED curve templates.

Syntax `show traffic-control red-curve <red-curve-name>`

Parameter	Description
<code><red-curve-name></code>	The name of the RED curve. The default RED curve is red-curve default limit 127 avpkt 576B min 10 max 32 prob 2.

Default None

Mode Privileged Exec

Usage notes If you have not configured some parameters, default values will display. If no RED curve name is given, all configured RED curves are shown.

Example To show all RED curves, use the command:

```
awplus# show traffic-control red-curve
```

To show a specified red curve called "TCP_session_1", use the command:

```
awplus# show traffic-control red-curve TCP_session_1
```

Output Figure 39-6: Example output from **show traffic-control red-curve**

```
awplus#show traffic-control red-curve
Traffic Control RED Curves:

RED curve default:
  Average packet size: 576 bytes
  Minimum: 10 packets
  Maximum: 32 packets
  Limit: 127 packets
  Drop probability: 2%
  ECN marking: disabled

RED curve TCP_session_1:
  Average packet size: 576 bytes
  Minimum: 20 packets
  Maximum: 60 packets
  Limit: 127 packets
  Drop probability: 20%
  ECN marking: disabled
```

Figure 39-7: Example output from **show traffic-control red-curve TCP_session_1**

```
awplus#show traffic-control red-curve TCP_session_1
Traffic Control RED Curves
RED curve TCP_session_1:
Average packet size: 576 bytes
Minimum: 20 packets
Maximum: 60 packets
Limit: 127 packets
Drop probability: 20%
ECN marking: disabled
```

**Related
commands**

[red-curve](#)
[show running-config](#)
[show running-config traffic-control](#)
[show traffic-control policy](#)

show traffic-control rule config-check

Overview Use this command to show information about traffic control rule validity.

Syntax `show traffic-control rule config-check`

Default None

Mode Privileged Exec

Usage An asterisk is printed before each rule that is invalid. To help determine why the rule is invalid, the `show traffic-control rule config-check` command will print the reasons why the rule is invalid. Information is only shown for invalid rules. If all rules are valid, a message will be printed showing all rules are valid.

Example To check if configured rules are valid, use the commands:

```
awplus#show traffic-control rule config-check
```

Output Figure 39-8: Example output from **show traffic-control rule config-check**

```
awplus#show traffic-control rule config-check

Rule 30:
  "From" entity does not exist
  "To" entity does not exist
  Policy doesn't exist or is not leaf
```

Related commands

- [move rule \(traffic-control\)](#)
- [rule \(traffic-control\)](#)
- [show traffic-control rule](#)
- [show running-config traffic-control](#)

show traffic-control rule

Overview Use this command to show specific rules or a complete list of rules configured for traffic control.

Syntax `show traffic-control rule [<1-65535>]`

Parameter	Description
<1-65535>	The ID of the rule you want to display. If no ID is entered, all rules are displayed.

Default None

Mode Privileged Exec

Usage An asterisk will be printed at the start of a row if the rule is invalid. The rules are shown in a table showing the rule ID, the application, source and destination that the rule matches on and the policy and class that the matching traffic will be sent to.

Examples To show a list of all traffic control rules configured, use the command:

```
awplus#show traffic-control rule
```

To show traffic control rule 10 configured, use the command:

```
awplus#show traffic-control rule 10
```

Output Figure 39-9: Example output from **show traffic-control rule**

```
awplus#show traffic-control rule

[* - Rule is not valid - see "show traffic-control rule config-check"]
  ID      APP          From           To             Policy
-----
  10      udp-5001        ipv6.vlan3     ipv6.eth2      A.B5001
  20      udp-5002        ipv6.vlan3     ipv6.eth2      A.B5002
* 30      aserf           asdf           fasdf          sadf.asdf
```

- Related commands**
- [move rule \(traffic-control\)](#)
 - [rule \(traffic-control\)](#)
 - [show running-config traffic-control](#)
 - [show traffic-control](#)
 - [show traffic-control rule config-check](#)

show traffic-control

Overview Use this command to display a brief overview of the status of the traffic control information on the router.

Syntax `show traffic-control`

Mode Privileged Exec

Usage This command shows if traffic control is enabled, how many rules are configured and how many interfaces have a virtual bandwidth applied.

Example To show an overview of the status of the traffic control information, use the commands:

```
awplus# show traffic-control
```

Output Figure 39-10: Example output from **show traffic-control**

```
awplus#show traffic-control
Traffic control is enabled
Policy configured on 5 interfaces
2 rules configured (2 valid rules)
Virtual-bandwidth configured on 1 interfaces
```

Related commands [traffic-control](#)
[traffic-control enable](#)

sub-class (htb)

Overview Use this command to configure a hierarchy token bucket (HTB) sub-class within an existing class.

Use the **no** variant of this command to delete an existing sub-class under the current class.

Syntax

```
sub-class <class-name> [cir <committed-rate>] [pir <peak-rate>]
[bc <1-100000000>] [be <1-100000000>] [preference <0-7>]
[queue-length <2-65536>] [set-dscp <dscp-value>] [red-curve
<red-curve-name>]

sub-class <class-name> [cir <committed-rate>] [pir <peak-rate>]
[bc <1-100000000>] [be <1-100000000>] [preference <0-7>]
sub-sub-class-policy htb

no sub-class <class-name>
```

Parameter	Description
<class-name>	Name of the class.
cir <committed-rate>	Set the Committed Information Rate (CIR) for the queue. Specified in kbit/mbit/gbit per second, 1kbit-100gbit. This parameter is compulsory when creating a new sub-class. When editing an existing sub-class, this parameter is optional.
pir <peak-rate>	Set the Peak Information Rate (PIR) for the queue. This is the rate of the queue under peak conditions. Specified in kbit/mbit/gbit per second, in the range 1kbit-100gbit.
bc <1-100000000>	Set the Committed Burst size (BC). This is the burst allowed above the CIR, sent at the PIR rate.
be <1-100000000>	Set the Excess Burst size (BE). This is the burst allowed above the PIR, sent at the maximum rate.
preference <0-7>	Set the preference for a class to receive spare bandwidth (highest is 7).
queue-length <2-65536>	Set the maximum queue length in packets.
set-dscp <dscp-value>	Set the DSCP value to apply to the packets.
red-curve <red-curve-name>	Apply a random early discard template with the sub-class and enter the name of the red curve template to apply.
sub-sub-class-policy	Specify that the sub-class will contain sub-sub-classes.
htb	Sub-sub-classes will use the Hierarchy Token Bucket (HTB) queueing discipline.

Default BC and BE are assigned suitable values proportional to the CIR and PIR respectively and are larger than the MTU. PIR defaults to the CIR. Preference defaults to 7 and the queue length default to 1000 if the class is a leaf.

Mode Traffic-Control Class for an HTB sub-class policy.

Usage If there is already a sub-class in the same level with the specified name, the command will replace the configuration of the existing sub class if it does not have any sub-sub-classes.

If you specify a sub-sub-class policy, this command puts you into sub-class mode so you can specify the sub-sub-class.

Examples To configure a leaf sub-class, use the commands:

```
awplus#configure terminal
awplus(config)#traffic-control
awplus(config-tc)#policy p01 htb
awplus(config-tc-policy)#class c01 cir 100mbit pir 150mbit
sub-class-policy htb
wplus(config-tc-class)#sub-class s02 cir 20mbit queue-length
200 red-curve s02-red
```

To enter Traffic-Control Class mode for an existing sub-class, use the commands:

```
awplus#configure terminal
awplus(config)#traffic-control
awplus(config-tc)#policy p01
awplus(config-tc-policy)#class c01
awplus(config-tc-class)#sub-class s01
awplus(config-tc-subclass)#
```

To delete an existing sub-class, use the commands:

```
awplus#configure terminal
awplus(config)#traffic-control
awplus(config-tc)#policy p01
awplus(config-tc-policy)#class c01
awplus(config-tc-class)#no sub-class s01
```

Related commands

- [class \(htb\)](#)
- [class \(priority\)](#)
- [policy \(traffic-control\)](#)
- [sub-sub-class \(htb\)](#)
- [traffic-control](#)

sub-class (priority)

Overview Use this command to configure a priority queue sub-class within a class.

Use the **no** variant of this command to delete an existing sub-class under the current class.

Syntax `sub-class <class-name> [priority-level <0-15>] [max <max-rate>]
[queue-length <2-65536>] [set-dscp <dscp_value>] [red-curve
<red-curve-name>]`

`sub-class <class-name> [priority-level <0-15>]`

`sub-sub-class-policy {priority|wrr|htb}`

`no sub-class <class-name>`

Parameter	Description
<code><class-name></code>	Name of the class.
<code>priority-level <0-15></code>	Set the priority level (15 is the highest). This parameter is compulsory when creating a new sub-class. When editing an existing sub-class, this parameter is optional.
<code>max <max-rate></code>	Set the maximum traffic rate of the queue (in kbit/mbit/gbit per second, 1kbit-100gbit).
<code>queue-length <2-65536></code>	Set the maximum queue length in packets.
<code>set-dscp<dscp-value></code>	Set the DSCP value to apply to the packets.
<code>red-curve <red-curve-name></code>	Apply a random early discard template with the sub class and enter the name of the red curve template to apply.
<code>sub-sub-class-policy</code>	Create a sub-sub-class for the policy.
<code>priority</code>	Sub-sub-classes will use the Priority Queue queueing algorithm.
<code>wrr</code>	Sub-sub-classes will use the Weighted Round Robin (WRR) queueing algorithm.
<code>htb</code>	Sub-classes will use the Hierarchy Token Bucket (HTB) queueing algorithm.

Default A priority queue sub class has no max rate, DSCP value or sub-sub class policy. The queue length is 1000 by default if the class is a leaf.

Mode Traffic-Control Class for a priority sub-class policy.

Usage If there is already a sub-class in the same level with the specified name, the command will replace the configuration of the existing sub class if it does not have any sub-sub classes.

If a sub-sub class policy is specified, this command uses the Traffic-Control Class mode to apply it.

Examples To configure a sub-class as the leaf class, use the commands:

```
awplus#configure terminal
awplus(config)#traffic-control
awplus(config-tc)#policy p01 priority
awplus(config-tc-policy)#class c01 priority-level 5
sub-class-policy priority
awplus(config-tc-class)#sub-class s02 priority-level 8 max
50mbit queue-length 200 red-curve ss01-red
```

To enter Traffic-Control Class mode for an existing sub-class, use the commands:

```
awplus#configure terminal
awplus(config)#traffic-control
awplus(config-tc)#policy p01 priority
awplus(config-tc-policy)#class c01
awplus(config-tc-class)#sub-class s01
awplus(config-tc-subclass)#
```

To delete an existing class, use the commands:

```
awplus#configure terminal
awplus(config)#traffic-control
awplus(config-tc)#policy p01
awplus(config-tc-policy)#class c01
awplus(config-tc-class)#no sub-class s01
```

**Related
commands**

[class \(priority\)](#)
[policy \(traffic-control\)](#)
[sub-sub-class \(htb\)](#)
[sub-sub-class \(priority\)](#)
[sub-sub-class \(wrr\)](#)
[traffic-control](#)

sub-class (wrr)

Overview Use this command to configure a Weighted Round-Robin (WRR) sub-class within a class.

Use the **no** variant of this command to delete an existing sub-class under the current class.

Syntax `sub-class <class-name> [weight <1-100>] [queue-length <2-65536>] [set-dscp <dscp-value>] [red-curve <red-curve-name>]`
`sub-class <class-name> [weight <1-100>] sub-sub-class-policy wrr`
`no sub-class <class-name>`

Parameter	Description
<code><class-name></code>	Name of the sub-class.
<code>weight<1-100></code>	Set the weight. The relative weight is the available bandwidth divided between sibling WRR classes according to the ratio of their configured weights. This parameter is compulsory when creating a new sub-class. When editing an existing sub-class, this parameter is optional.
<code>queue-length<2-65536></code>	Set the maximum queue length in packets.
<code>set-dscp</code>	Set the DSCP value to apply to packets.
<code><dscp-value></code>	DSCP value as an integer or lower-case DSCP name.
<code>red curve <red-curve-name></code>	Apply a random early discard template with the sub-class and enter the name of the red curve template to apply.
<code>sub-sub-class-policy</code>	Create a sub-sub-class within the policy.
<code>wrr</code>	Sub sub classes use the Weighted Round Robin queueing discipline.

Default A weighted round-robin sub class has no DSCP value or sub-sub-class policy. The queue length is 1000 by default.

Mode Traffic-Control Class for a WRR sub-class policy.

Usage If there is already a class in the same level with the specified name, the command will replace the configuration of the existing class if it does not have any sub-classes.

If a sub class policy is specified, this command uses the Traffic-Control Class mode to apply it.

Examples To configure a sub-class as a leaf class, use the commands:

```
awplus#configure terminal
awplus(config)#traffic-control
awplus(config-tc)#policy p01 wrr
awplus(config-tc-policy)#class c02 weight 30 sub-class-policy
wrr
awplus(config-tc-class)#sub-class s02 weight 40 queue-length
200 red-curve s02-red
```

To enter Traffic-Control Class mode for an existing sub-class, use the commands:

```
awplus#configure terminal
awplus(config)#traffic-control
awplus(config-tc)#policy p01
awplus(config-tc-policy)#class c01
awplus(config-tc-class)#sub-class s01
awplus(config-tc-subclass)#
```

To delete an existing sub-class, use the commands:

```
awplus#configure terminal
awplus(config)#traffic-control
awplus(config-tc)#policy p01
awplus(config-tc-policy)#class c01
awplus(config-tc-class)#no sub-class s01
```

**Related
commands**

[class \(priority\)](#)
[class \(wrr\)](#)
[policy \(traffic-control\)](#)
[traffic-control](#)
[sub-sub-class \(wrr\)](#)

sub-sub-class (htb)

Overview Use this command to configure a Hierarchy Token Bucket (HTB) sub-sub-class for a sub-class.

Use the **no** variant of this command to delete an existing sub-sub-class from the current sub-class.

Syntax `sub-sub-class <class-name> [cir <committed-rate>] [pir <peak-rate>] [bc <1-100000000>] [be <1-100000000>] [preference <0-7>] [queue-length <2-65536>] [set-dscp <dscp-value>] [red-curve <red-curve-name>]`
`no sub-sub-class <class-name>`

Parameter	Description
<code><class-name></code>	Name of the sub-sub-class.
<code>cir <committed-rate></code>	Set the Committed Information Rate (CIR) for the queue. Specified in kbit/mbit/gbit per second, 1kbit-100gbit. This parameter is compulsory when creating a new sub-sub-class. When editing an existing sub-sub-class, this parameter is optional.
<code>pir <peak-rate></code>	Set the Peak Information Rate (PIR) for the queue. This is the rate of the queue under peak conditions. Specified in kbit/mbit/gbit per second, in the range 1kbit-100gbit.
<code>bc <1-100000000></code>	Set the Committed Burst size (BC). This is the burst allowed above the CIR, sent at the PIR rate.
<code>be <1-100000000></code>	Set the Excess Burst size (BE. This is the burst allowed above the PIR, sent at the maximum rate..
<code>preference <0-7></code>	Set the preference for a class to receive spare bandwidth (highest is 7).
<code>queue-length <2-65536></code>	Set the maximum queue length.
<code>set-dscp <dscp-value></code>	Set the DSCP value to apply to the packets.
<code>red-curve <red-curve-name></code>	Apply a random early discard template with the sub-sub-class and enter the name of the red curve template to apply.

Default BC and BE are assigned suitable values proportional to the CIR and PIR respectively and are larger than the MTU. PIR defaults to the CIR. Preference defaults to 7 and Queue length defaults to 1000.

Mode Traffic-Control Sub-class for an HTB sub-sub-class policy.

Usage If there is already a sub-sub-class in the same level with the specified name, this command will replace the configuration of the existing sub-sub-class.

Examples To configure a sub-sub-class, use the commands:

```
awplus#configure terminal
awplus(config)#traffic-control
awplus(config-tc)#policy p01 htb
awplus(config-tc-policy)#class c01 cir 100mbit pir 150mbit
sub-class-policy htb
awplus(config-tc-class)#sub-class s01 cir 10mbit
```

To configure a leaf sub-sub-class with a RED curve, use the commands:

```
awplus#configure terminal
awplus(config)#traffic-control
awplus(config-tc)#policy p01 htb
awplus(config-tc-policy)#class c01 cir 100mbit pir 150mbit
sub-class-policy htb
awplus(config-tc-class)#sub-class s01 cir 10mbit
sub-sub-class-policy htb
awplus(config-tc-subclass)#sub-sub-class ss01 cir 5mbit
queue-length 200 red-curve ss01-red
```

To delete an existing sub-sub-class, use the commands:

```
awplus#configure terminal
awplus(config)#traffic-control
awplus(config-tc)#policy p01
awplus(config-tc-policy)#class c01
awplus(config-tc-class)#sub-class s01
awplus(config-tc-subclass)#no sub-sub-class ss01
```

Related commands

- [policy \(traffic-control\)](#)
- [sub-class \(htb\)](#)
- [sub-class \(priority\)](#)
- [traffic-control](#)

sub-sub-class (priority)

Overview Use this command to configure a priority queue sub-sub-class for a sub-class.
Use the **no** variant of this command to delete an existing sub-sub-class from the current sub-class.

Syntax `sub-sub-class <class-name> [priority-level <0-15>] [max <max-rate>] [queue-length <2-65536>] [set-dscp <dscp-value>] [red-curve <red-curve-name>]`
`no sub-sub-class <class-name>`

Parameter	Description
<code><class-name></code>	Name of the class.
<code>priority-level <0-15></code>	Set the priority level (15 is the highest). This parameter is compulsory when creating a new sub-sub-class. When editing an existing sub-sub-class, this parameter is optional.
<code>max <max-rate></code>	Set the maximum traffic rate of the queue (in kbit/mbit/gbit per second, 1kbit-100gbit).
<code>queue-length <2-65536></code>	Set the maximum queue length in packets.
<code>set-dscp <dscp-value></code>	Set the DSCP value to apply to the packets.
<code>red-curve <red-curve-name></code>	Apply a random early discard template with the sub-sub-class and enter the name of the red curve template to apply.

Default A priority queue sub-sub-class has no max rate or DSCP value. The queue length is 1000.

Mode Traffic-Control Sub-class for a priority sub-sub-class policy.

Usage If there is already a sub-sub-class in the same level with the specified name, this command will replace the configuration of the existing sub-sub-class.

Examples To configure a sub-sub-class, use the commands:

```
awplus#configure terminal
awplus(config)#traffic-control
awplus(config-tc)#policy p01 priority
awplus(config-tc-policy)#class c01 priority-level 5
awplus(config-tc-class)#sub-class s01 priority-level 7
awplus(config-tc-subclass)#sub-sub-class ss01 priority-level 3
```

To configure a sub-sub-class with a RED curve, use the commands:

```
awplus#configure terminal
awplus(config)#traffic-control
awplus(config-tc)#policy p01 priority
awplus(config-tc-policy)#class c01 priority-level 5
sub-class-policy priority
awplus(config-tc-class)#sub-class s01 priority-level 7
sub-sub-class-policy priority
awplus(config-tc-subclass)#sub-sub-class ss01 priority-level 3
max 5mbit queue-length 200 red-curve ss01-red
```

To delete an existing sub-sub-class, use the commands:

```
awplus#configure terminal
awplus(config)#traffic-control
awplus(config-tc)#policy p01
awplus(config-tc-policy)#class c01
awplus(config-tc-class)#sub-class s01
awplus(config-tc-subclass)#no sub-sub-class ss01
```

Related commands

- [traffic-control](#)
- [policy \(traffic-control\)](#)
- [sub-class \(priority\)](#)

sub-sub-class (wrr)

Overview Use this command to configure a Weighted Round-Robin (WRR) sub-sub-class within a sub-class.

Use the **no** variant of this command to delete an existing sub-sub-class from the current sub-class.

Syntax `sub-sub-class <class-name> [weight <1-100>] [queue-length <2-65536>] [set-dscp <dscp-value>] [red-curve <red-curve-name>]`
`no sub-sub-class <class-name>`

Parameter	Description
<code><class-name></code>	Name of the sub-class.
<code>weight <1-100></code>	Set the weight. The relative weight is the available bandwidth divided between sibling WRR classes according to the ratio of their configured weights. This parameter is compulsory when creating a new sub-sub-class. When editing an existing sub-sub-class, this parameter is optional.
<code>queue-length <2-65536></code>	Set the maximum queue length in packets.
<code>set-dscp <dscp-value></code>	Set the DSCP value to apply to packets.
<code>red-curve <red-curve-name></code>	Apply a random early discard template with the sub-sub-class and enter the name of the red curve template to apply.

Default A weighted round-robin sub-sub-class has no DSCP value. The queue length is 1000 by default.

Mode Traffic-Control Sub-class for a WRR sub-sub-class policy.

Usage If there is already a sub-sub-class in the same level with the specified name, this command will replace the configuration of the existing sub-sub-class.

Examples To configure a sub-sub-class as a leaf class, use the commands:

```
awplus#configure terminal
awplus(config)#traffic-control
awplus(config-tc)#policy p01 wrr
awplus(config-tc-policy)#class c01 weight 50 sub-class-policy
wrr
awplus(config-tc-class)#sub-class s01 weight 30 sub-sub-class
policy wrr
awplus(config-tc-subclass)#sub-sub-class ss01 weight 5
queue-length 200
```

To configure a sub-sub-class with a RED curve, use the commands:

```
awplus#configure terminal
awplus(config)#traffic-control
awplus(config-tc)#policy p01 wrr
awplus(config-tc-policy)#class c01 weight 50 sub-class-policy
wrr
awplus(config-tc-class)#sub-class s01 weight 30
sub-sub-class-policy wrr
awplus(config-tc-subclass)#sub-sub-class ss01 weight 5
queue-length 200 red-curve ss01-red
```

To delete an existing sub-sub-class, use the commands:

```
awplus#configure terminal
awplus(config)#traffic-control
awplus(config-tc)#policy p01 htb
awplus(config-tc-policy)#class c01
awplus(config-tc-class)#sub-class s01
awplus(config-tc-subclass)#no sub-sub-class ss01
```

**Related
commands**

[traffic-control](#)
[policy \(traffic-control\)](#)
[sub-class \(priority\)](#)
[sub-class \(wrr\)](#)

traffic-control enable

Overview Use this command to enable traffic control.
Use the **no** variant of this command to disable traffic control without losing your existing traffic control configuration.

Syntax `traffic-control enable`
`no traffic-control enable`

Default Disabled

Mode Traffic-Control

Usage When traffic control is enabled and no rules are added, a default queueing discipline is applied to all interfaces that support traffic control. You can use the `policy` command to configure traffic control policies and the `rule (traffic-control)` command to apply the configured policies to the traffic.

Examples To enable traffic control, use the commands:

```
awplus#configure terminal
awplus (config) #traffic-control
awplus (config-tc) #traffic-control enable
```

To disable traffic control, use the commands:

```
awplus#configure terminal
awplus (config) #traffic-control
awplus (config-tc) #no traffic-control enable
```

Related commands [policy \(traffic-control\)](#)
[rule \(traffic-control\)](#)
[traffic-control](#)

traffic-control

Overview Use this command to enter into Traffic-Control configuration mode.
Use the **no** variant of this command to remove all traffic control configuration.

Syntax `traffic-control`
`no traffic-control`

Default Disabled

Mode Global Configuration

Usage This command enters you into Traffic-Control configuration mode.
In Traffic-Control Configuration mode you can:

- enable or disable traffic control
- create and delete traffic control policies
- create, move and delete rules for traffic control
- set and unset packet overhead, system bandwidth and virtual bandwidth of interfaces

Examples To configure traffic-control, use the commands:

```
awplus#configure terminal
awplus(config)#traffic-control
awplus(config-tc)#
```

To remove all traffic control configuration, use the commands:

```
awplus#configure terminal
awplus(config)#no traffic-control
awplus(config)#
```

Related commands

- [class \(htb\)](#)
- [class \(priority\)](#)
- [class \(wrr\)](#)
- [debug traffic-control](#)
- [interface \(traffic-control\)](#)
- [move rule \(traffic-control\)](#)
- [policy \(traffic-control\)](#)
- [rule \(traffic-control\)](#)
- [traffic-control enable](#)
- [show debugging traffic-control](#)

show running-config traffic-control
show traffic-control
show traffic-control counters
show traffic-control interface
show traffic-control policy
show traffic-control rule
show traffic-control rule config-check
sub-class (htb)
sub-class (priority)
sub-class (wrr)
sub-sub-class (htb)
sub-sub-class (priority)
sub-sub-class (wrr)

40

802.1X Commands

Introduction

Overview 802.1X is an IEEE standard providing a mechanism for authenticating devices attached to a LAN port or wireless device. Devices wishing to access services behind a port must authenticate themselves before any Ethernet packets are allowed to pass through. The protocol is referred to as 802.1X because it was initially defined in the IEEE standard 802.1X, published in 2001 and revised in 2004 and again as the current 802.1X 2010 standard.

The AR2050V supports 802.1X authentication with the following limitations:

- Only supported on the device's switch ports.
- Not supported on static channel-groups and dynamic (LACP) channel-groups.

This chapter provides an alphabetical reference of commands used to configure 802.1X port access control. For more information, see the [AAA and Port Authentication_Feature Overview and Configuration Guide](#).

- Command List**
- ["dot1x accounting"](#) on page 2072
 - ["dot1x authentication"](#) on page 2073
 - ["debug dot1x"](#) on page 2074
 - ["dot1x control-direction"](#) on page 2075
 - ["dot1x eap"](#) on page 2077
 - ["dot1x eapol-version"](#) on page 2078
 - ["dot1x initialize interface"](#) on page 2079
 - ["dot1x initialize supplicant"](#) on page 2080
 - ["dot1x keytransmit"](#) on page 2081
 - ["dot1x max-auth-fail"](#) on page 2082
 - ["dot1x max-reauth-req"](#) on page 2084

- [“dot1x port-control”](#) on page 2086
- [“dot1x timeout tx-period”](#) on page 2088
- [“show debugging dot1x”](#) on page 2089
- [“show dot1x”](#) on page 2090
- [“show dot1x diagnostics”](#) on page 2093
- [“show dot1x interface”](#) on page 2095
- [“show dot1x sessionstatistics”](#) on page 2097
- [“show dot1x statistics interface”](#) on page 2098
- [“show dot1x supplicant”](#) on page 2099
- [“show dot1x supplicant interface”](#) on page 2101
- [“undebg dot1x”](#) on page 2103

dot1x accounting

Overview This command overrides the **default** RADIUS accounting method for IEEE 802.1X-based authentication on an interface by allowing you to apply a user-defined named method list.

Use the **no** variant of this command to remove the named list from the interface and apply the **default** method list.

Syntax dot1x accounting {default|<list-name>}
no dot1x accounting

Parameter	Description
default	Apply the default accounting method list
<list-name>	Apply the user-defined named list

Default The **default** method list is applied to an interface by default.

Mode Interface Configuration for a switch port; or Authentication Profile mode.

Example To apply the named list 'vlan10_acct' on the vlan10 interface, use the commands:

```
awplus# configure terminal
awplus(config)# interface vlan10
awplus(config-if)# dot1x accounting vlan10_acct
```

To remove the named list from the vlan10 interface and set the authentication method back to **default**, use the commands:

```
awplus# configure terminal
awplus(config)# interface vlan10
awplus(config-if)# no dot1x accounting
```

Related commands [aaa accounting dot1x](#)

Command changes Version 5.4.9-2.1: command added to AR2050V, AR3050S, and AR4050S

dot1x authentication

Overview This command overrides the **default** 802.1X-based authentication method on an interface by allowing you to apply a user-defined named list.

Use the **no** variant of this command to remove the named list from the interface and apply the **default** method.

Syntax dot1x authentication {default|<list-name>}
no dot1x authentication

Parameter	Description
<i>default</i>	Apply the default authentication method list
<list-name>	Apply the user-defined named list

Default The **default** method list is applied to an interface by default.

Mode Interface Configuration for a switch port; or Authentication Profile mode.

Example To apply the named list 'vlan10_auth' on the vlan10 interface, use the commands:

```
awplus# configure terminal
awplus(config)# interface vlan10
awplus(config-if)# dot1x authentication vlan10_auth
```

To remove the named list from the vlan10 interface and set the authentication method back to **default**, use the commands:

```
awplus# configure terminal
awplus(config)# interface vlan10
awplus(config-if)# no dot1x authentication
```

Related commands [aaa authentication dot1x](#)

Command changes Version 5.4.9-2.1: command added to AR2050V, AR3050S, and AR4050S

debug dot1x

Overview Use this command to enable 802.1X IEEE Port-Based Network Access Control troubleshooting functions.

Use the **no** variant of this command to disable this function.

Syntax debug dot1x [all|auth-web|event|nsm|packet|timer]
no debug all dot1x
no debug dot1x [all|auth-web|event|nsm|packet|timer]

Parameter	Description
all	Used with the no variant of this command exclusively; turns off all debugging for 802.1X.
auth-web	Specifies debugging for 802.1X auth-web information.
events	Specifies debugging for 802.1X events.
nsm	Specifies debugging for NSM messages.
packet	Specifies debugging for 802.1X packets.
timer	Specifies debugging for 802.1X timers.

Mode Privileged Exec and Global Configuration

Usage notes This command turns on a mode where trace-level information is output during authentication conversations. Be aware that this is a very verbose output. It is mostly useful to capture this as part of escalating an issue to ATI support.

Examples Use this command without any parameters to turn on normal 802.1X debug information.

```
awplus# debug dot1x  
awplus# show debugging dot1x
```

```
802.1X debugging status:  
802.1X events debugging is  
802.1X timer debugging is on  
802.1X packets debugging is on  
802.1X NSM debugging is on
```

Related commands [show debugging dot1x](#)
[undebug dot1x](#)

Command changes Version 5.4.9-2.1: command added to AR2050V, AR3050S, and AR4050S

dot1x control-direction

Overview This command sets the direction of the filter for the unauthorized interface. If the optional **in** parameter is specified with this command then packets entering the specified port are discarded. The **in** parameter discards the ingress packets received from the supplicant.

If the optional **both** parameter is specified with this command then packets entering (ingress) and leaving (egress) the specified port are discarded. The **both** parameter discards the packets received from the supplicant and sent to the supplicant.

The **no** variant of this command sets the direction of the filter to **both**. The port will then discard both ingress and egress traffic.

Syntax dot1x control-direction {in|both}
no dot1x control-direction

Parameter	Description
in	Discard received packets from the supplicant (ingress packets).
both	Discard received packets from the supplicant (ingress packets) and transmitted packets to the supplicant (egress packets).

Default The authentication port direction is set to **both** by default.

Mode Interface Configuration for a switch port; or Authentication Profile mode.

Examples To set the port direction to the default (**both**) for port1.0.2, use the commands:

```
awplus# configure terminal  
awplus(config)# interface port1.0.2  
awplus(config-if)# no dot1x control-direction
```

To set the port direction to **in** for port1.0.2, use the commands:

```
awplus# configure terminal  
awplus(config)# interface port1.0.2  
awplus(config-if)# dot1x control-direction in
```

To set the port direction to **in** for authentication profile 'student', use the commands:

```
awplus# configure terminal  
awplus(config)# auth profile student  
awplus(config-auth-profile)# dot1x control-direction in
```

Related commands auth profile (global)
show dot1x
show dot1x interface
show auth interface

Command changes Version 5.4.9-2.1: command added to AR2050V, AR3050S, and AR4050S

dot1x eap

Overview This command selects the transmit mode for the EAP packet. If the authentication feature is not enabled then EAP transmit mode is not enabled. The default setting discards EAP packets.

Syntax `dot1x eap {discard|forward|forward-untagged-vlan|forward-vlan}`

Parameter	Description
discard	Discard.
forward	Forward to all ports on the switch.
forward-untagged-vlan	Forward to ports with the same untagged VLAN.
forward-vlan	Forward to ports with the same VLAN.

Default The transmit mode is set to `discard` EAP packets by default.

Mode Global Configuration

Examples To set the transmit mode of EAP packet to **forward**, to forward EAP packets to all ports on the switch, use the commands:

```
awplus# configure terminal
awplus(config)# dot1x eap forward
```

To set the transmit mode of EAP packet to **discard**, to discard EAP packets, use the commands:

```
awplus# configure terminal
awplus(config)# dot1x eap discard
```

To set the transmit mode of EAP packet to **forward-untagged-vlan**, to forward EAP packets to ports with the same untagged VLAN, use the commands:

```
awplus# configure terminal
awplus(config)# dot1x eap forward-untagged-vlan
```

To set the transmit mode of EAP packet to **forward-vlan**, to forward EAP packets to ports with the same VLAN, use the commands:

```
awplus# configure terminal
awplus(config)# dot1x eap forward-vlan
```

Command changes Version 5.4.9-2.1: command added to AR2050V, AR3050S, and AR4050S

dot1x eapol-version

Overview This command sets the EAPOL protocol version for EAP packets when 802.1X port authentication is applied.

Use the **no** variant of this command to set the EAPOL protocol version to 1.

The default EAPOL protocol version is version 1.

Syntax dot1x eapol-version {1|2}
no dot1x eapol-version

Parameter	Description
1 2	EAPOL protocol version 1 or 2.

Default The EAP version for 802.1X authentication is set to 1 by default.

Mode Interface Configuration for a switch port; or Authentication Profile mode.

Examples To set the EAPOL protocol version to 2 for port1.0.2, use the commands:

```
awplus# configure terminal
awplus(config)# interface port1.0.2
awplus(config-if)# dot1x eapol-version 2
```

To set the EAPOL protocol version to the default version (1) for interface port1.0.2, use the commands:

```
awplus# configure terminal
awplus(config)# interface port1.0.2
awplus(config-if)# no dot1x eapol-version
```

To set the EAPOL protocol version to 2 for authentication profile 'student', use the commands:

```
awplus# configure terminal
awplus(config)# auth profile student
awplus(config-auth-profile)# dot1x eapol-version 2
```

Validation Commands auth profile (global)

show dot1x

show dot1x interface

Command changes Version 5.4.9-2.1: command added to AR2050V, AR3050S, and AR4050S

dot1x initialize interface

Overview This command removes authorization for a specified connected interface. The connection will attempt to re-authorize when the specified port attempts to make use of the network connection.

NOTE: *Reauthentication could be a long time after the use of this command because the reauthorization attempt is not triggered by this command. The attempt is triggered by the first packet from the interface trying to access the network resources.*

Syntax `dot1x initialize interface <interface-list>`

Parameter	Description
<code><interface-list></code>	The interfaces or ports to configure. An interface-list can be: <ul style="list-style-type: none">• a VLAN (e.g. vlan2)• a switchport (e.g. port1.0.4)• a continuous range of interfaces separated by a hyphen (e.g. port1.0.1-port1.0.3)• a comma-separated list (e.g. port1.0.1, port1.0.3-port1.0.4). Do not mix interface types in a list. The specified interfaces must exist.

Mode Privileged Exec

Examples To initialize 802.1X port authentication on the interface port1.0.2, use the command:

```
awplus# dot1x initialize interface port1.0.2
```

To unauthorize switch port1.0.2 and attempt reauthentication on switch port1.0.2, use the command:

```
awplus# dot1x initialize interface port1.0.2
```

To unauthorize all switch ports for a 18-port device and attempt reauthentication, use the command:

```
awplus# dot1x initialize interface port1.0.1-port1.0.18
```

Related commands

- [dot1x initialize supplicant](#)
- [show dot1x](#)
- [show dot1x interface](#)

Command changes Version 5.4.9-2.1: command added to AR2050V, AR3050S, and AR4050S

dot1x initialize supplicant

Overview This command removes authorization for a connected supplicant with the specified MAC address or username. The connection will attempt to re-authorize when the specified supplicant attempts to make use of the network connection.

NOTE: *Reauthentication could be a long time after the use of this command because the reauthorization attempt is not triggered by this command. The attempt is triggered by the first packet from the supplicant trying to access the network resources.*

Syntax `dot1x initialize supplicant {<macadd>|username}`

Parameter	Description
dot1x	IEEE 802.1X Port-Based Access Control.
initialize	Initialize the port to attempt reauthentication.
supplicant	Specify the supplicant to initialize.
<macadd>	MAC (hardware address of the supplicant.
username	The name of the supplicant entry.

Mode Privileged Exec

Example To initialize the supplicant authentication, use the commands

```
awplus# configure terminal
awplus(config)# dot1x initialize supplicant 0090.99ab.a020
awplus(config)# dot1x initialize supplicant guest
```

Related commands [dot1x initialize interface](#)
[show dot1x](#)
[show dot1x supplicant](#)

Command changes Version 5.4.9-2.1: command added to AR2050V, AR3050S, and AR4050S

dot1x keytransmit

Overview Use this command to enable key transmission on the interface specified previously in Interface mode.

This command enables key transmission over an Extensible Authentication Protocol (EAP) packet between the authenticator and supplicant.

The **no** variant of this command disables key transmission on the interface specified.

Syntax dot1x keytransmit
no dot1x keytransmit

Default Key transmission for port authentication is disabled by default.

Mode Interface Configuration for a switch port; or Authentication Profile mode.

Examples To enable the key transmit feature on interface port1.0.2, use the commands:

```
awplus# configure terminal
awplus(config)# interface port1.0.2
awplus(config-if)# dot1x keytransmit
```

To disable the key transmit feature on interface port1.0.2, use the commands:

```
awplus# configure terminal
awplus(config)# interface port1.0.2
awplus(config-if)# no dot1x keytransmit
```

Related commands [show dot1x](#)
[show dot1x interface](#)

Command changes Version 5.4.9-2.1: command added to AR2050V, AR3050S, and AR4050S

dot1x max-auth-fail

Overview Use this command to configure the maximum number of login attempts for a supplicant (client device) using the **auth-fail vlan** feature, when using 802.1X port authentication on an interface.

The **no** variant of this command resets the maximum login attempts for a supplicant (client device) using the auth-fail vlan feature, to the default configuration of 3 login attempts.

Syntax dot1x max-auth-fail <0-10>
no dot1x max-auth-fail

Parameter	Description
<0-10>	Specify the maximum number of login attempts for supplicants on an interface using 802.1X port authentication.

Default The default maximum number of login attempts for a supplicant on an interface using 802.1X port authentication is 3 login attempts.

Mode Interface Configuration for a switch port; or Authentication Profile mode.

Usage notes This command sets the maximum number of login attempts for supplicants on an interface. The supplicant is moved to the auth-fail VLAN from the Guest VLAN after the number of failed login attempts using 802.1X authentication is equal to the number set with this command.

See the [AAA and Port Authentication Feature Overview and Configuration Guide](#) for information about:

- the auth-fail VLAN feature, and
- restrictions regarding combinations of authentication enhancements working together

Examples To configure the maximum number of login attempts for a supplicant on interface port1.0.2 to a single login attempt, use the commands:

```
awplus# configure terminal
awplus(config)# interface port1.0.2
awplus(config-if)# dot1x max-auth-fail 1
```

To configure the maximum number of login attempts for a supplicant on interface port1.0.2 to the default number of 3 login attempts, use the commands:

```
awplus# configure terminal
awplus(config)# interface port1.0.2
awplus(config-if)# no dot1x max-auth-fail
```

To configure the maximum number of login attempts for a supplicant on authentication profile 'student' to a single login attempt, use the commands:

```
awplus# configure terminal
awplus(config)# auth profile student
awplus(config-auth-profile)# dot1x max-auth-fail 1
```

**Related
commands**

[auth auth-fail vlan](#)
[auth profile \(global\)](#)
[dot1x max-reauth-req](#)
[show dot1x interface](#)

**Command
changes**

Version 5.4.9-2.1: command added to AR2050V, AR3050S, and AR4050S

dot1x max-reauth-req

Overview Use this command to set the number of reauthentication attempts before an interface is unauthorized.

The **no** variant of this command resets the reauthentication delay to the default.

Syntax `dot1x max-reauth-req <1-10>`
`no dot1x max-reauth-req`

Parameter	Description
<1-10>	Specify the maximum number of reauthentication attempts for supplicants on an interface using 802.1X port authentication.

Default The default maximum reauthentication attempts for interfaces using 802.1X port authentication is two (2) reauthentication attempts, before an interface is unauthorized.

Mode Interface Configuration for a switch port; or Authentication Profile mode.

Usage notes Use this command to set the maximum reauthentication attempts after failure.

Examples To configure the maximum number of reauthentication attempts for interface port1.0.2 to a single (1) reauthentication request, use the commands:

```
awplus# configure terminal
awplus(config)# interface port1.0.2
awplus(config-if)# dot1x max-reauth-req 1
```

To configure the maximum number of reauthentication attempts for interface port1.0.2 to the default maximum number of two (2) reauthentication attempts, use the commands:

```
awplus(config)# interface port1.0.2
awplus(config-if)# no dot1x max-reauth-req
```

To configure the maximum number of reauthentication attempts for authentication profile 'student' to a single (1) reauthentication request, use the commands:

```
awplus# configure terminal
awplus(config)# auth profile student
awplus(config-auth-profile)# dot1x max-reauth-req 1
```

Related commands [auth profile \(global\)](#)
[dot1x max-auth-fail](#)
[show dot1x interface](#)

Command changes Version 5.4.9-2.1: command added to AR2050V, AR3050S, and AR4050S

dot1x port-control

Overview This command enables 802.1X port authentication on the interface specified, and sets the control of the authentication port.

The **no** variant of this command disables the port authentication on the interface specified.

Syntax `dot1x port-control {force-unauthorized|force-authorized|auto}`
`no dot1x port-control`

Parameter	Description
<code>force-unauthorized</code>	Force the port state to unauthorized. Specify this to force a port to always be in an unauthorized state.
<code>force-authorized</code>	Force the port state to authorized. Specify this to force a port to always be in an authorized state.
<code>auto</code>	Allow the port client to negotiate authentication. Specify this to enable authentication on the port.

Default 802.1X port control is disabled by default.

Mode Interface Configuration for a switch port; or Authentication Profile mode.

Usage notes Use this command to force a port state.

When **port-control** is set to **auto**, the 802.1X authentication feature is executed on the interface, but only if the **aaa authentication dot1x** command has been issued.

If you attempt to change the authentication configuration on an interface that has threat protection quarantine configured, you will see the following error message:

```
% portx.x.x: Application Proxy quarantine configuration must be removed before port authentication is changed
```

Before changing the interface's authentication configuration you must either:

- remove the interface's threat protection configuration, or
- shut down the interface.

Examples To enable port authentication on the interface port1.0.2, use the commands:

```
awplus# configure terminal
awplus(config)# interface port1.0.2
awplus(config-if)# dot1x port-control auto
```

To enable port authentication force authorized on the interface port1.0.2, use the commands:

```
awplus# configure terminal
awplus(config)# interface port1.0.2
awplus(config-if)# dot1x port-control force-authorized
```

To disable port authentication on the interface port1.0.2 use the commands:

```
awplus# configure terminal
awplus(config)# interface port1.0.2
awplus(config-if)# no dot1x port-control
```

To enable port authentication on authentication profile 'student', use the commands:

```
awplus# configure terminal
awplus(config)# auth profile student
awplus(config-auth-profile)# dot1x port-control auto
```

**Related
commands**

[aaa authentication dot1x](#)
[auth profile \(global\)](#)
[show dot1x interface](#)

**Command
changes**

Version 5.4.9-2.1: command added to AR2050V, AR3050S, and AR4050S

dot1x timeout tx-period

Overview This command sets the transmit timeout for the authentication request on the specified interface.

The **no** variant of this command resets the transmit timeout period to the default (30 seconds).

Syntax dot1x timeout tx-period <1-65535>
no dot1x timeout tx-period

Parameter	Description
<1-65535>	Seconds.

Default The default transmit period for port authentication is 30 seconds.

Mode Interface Configuration for a switch port; or Authentication Profile mode.

Usage notes Use this command to set the interval between successive attempts to request an ID.

Examples To set the transmit timeout period to 5 seconds on interface port1.0.2, use the commands:

```
awplus# configure terminal
awplus(config)# interface port1.0.2
awplus(config-if)# dot1x timeout tx-period 5
```

To reset transmit timeout period to the default (30 seconds) on interface port1.0.2, use the commands:

```
awplus# configure terminal
awplus(config)# interface port1.0.2
awplus(config-if)# no dot1x timeout tx-period
```

To set the transmit timeout period to 5 seconds on authentication profile 'student', use the commands:

```
awplus# configure terminal
awplus(config)# auth profile student
awplus(config-auth-profile)# dot1x timeout tx-period 5
```

Related commands [auth profile \(global\)](#)
[show dot1x](#)
[show dot1x interface](#)

Command changes Version 5.4.9-2.1: command added to AR2050V, AR3050S, and AR4050S

show debugging dot1x

Overview Use this command to see what debugging is turned on for 802.1X.
For information on filtering and saving command output, see the [“Getting Started with AlliedWare Plus” Feature Overview and Configuration Guide](#).

Syntax `show debugging dot1x`

Mode User Exec and Privileged Exec

Example To enable 802.1X debugging and display the debugging option set, use the following commands:

```
awplus# debug dot1x
awplus# show debugging dot1x
```

```
802.1X debugging status:
 802.1X events debugging is on
 802.1X timer debugging is on
 802.1X packets debugging is on
 802.1X NSM debugging is on
```

Related commands [debug dot1x](#)

Command changes Version 5.4.9-2.1: command added to AR2050V, AR3050S, and AR4050S

show dot1x

Overview Use this command to show authentication information for 802.1X port authentication.

If you specify the optional **all** parameter then this command also displays all authentication information for each port available on the switch.

For information on filtering and saving command output, see the [“Getting Started with AlliedWare_Plus” Feature Overview and Configuration Guide](#).

Syntax `show dot1x [all]`

Parameter	Description
all	Displays all authentication information for each port available on the switch.

Mode Privileged Exec

Example `awplus# show dot1x all`

Table 1: Example output from the **show dot1x all** command

```
awplus# show dot1x all
802.1X Port-Based Authentication Enabled
RADIUS server address: 150.87.18.89:1812
Next radius message id: 5
RADIUS client address: not configured
Authentication info for interface port1.0.2
portEnabled: true - portControl: Auto
portStatus: Authorized
reAuthenticate: disabled
reAuthPeriod: 3600
PAE: quietPeriod: 60 - maxReauthReq: 2 - txPeriod: 30
PAE: connectTimeout: 30
BE: suppTimeout: 30 - serverTimeout: 30
CD: adminControlledDirections: in
KT: keyTxEnabled: false
critical: disabled
guestVlan: disabled
dynamicVlanCreation: single-dynamic-vlan
multiVlanSession: disabled
assignFailActionRule: deny
hostMode: multi-supPLICANT
maxsupPLICANT: 1024
```

Table 1: Example output from the **show dot1x all** command (cont.)

```
dot1x: enabled
protocolVersion: 1
authMac: enabled
method: PAP
reauthRelearning: disabled
authWeb: enabled
method: PAP
lockCount: 3
packetForwarding: disabled
twoStepAuthentication:
    configured: enabled
    actual: enabled
SupplicantMac: none
supplicantMac: none
Supplicant name: manager
Supplicant address: 00d0.59ab.7037
    authenticationMethod: 802.1X Authentication
    portStatus: Authorized - currentId: 1
    abort:F fail:F start:F timeout:F success:T
    PAE: state: Authenticated - portMode: Auto
    PAE: reAuthCount: 0 - rxRespId: 0
    PAE: quietPeriod: 60 - maxReauthReq: 2 - txPeriod: 30
    BE: state: Idle - reqCount: 0 - idFromServer: 0
    CD: adminControlledDirections: in - operControlledDirections: in
    CD: bridgeDetected: false
    KR: rxKey: false
    KT: keyAvailable: false - keyTxEnabled: false
    criticalState: off
    dynamicVlanId: 2
802.1X statistics for interface port1.0.2
    EAPOL Frames Rx: 5 - EAPOL Frames Tx: 16
    EAPOL Start Frames Rx: 0 - EAPOL Logoff Frames Rx: 0
    EAP Rsp/Id Frames Rx: 3 - EAP Response Frames Rx: 2
    EAP Req/Id Frames Tx: 8 - EAP Request Frames Tx: 2
    Invalid EAPOL Frames Rx: 0 - EAP Length Error Frames Rx: 0
    EAPOL Last Frame Version Rx: 1 - EAPOL Last Frame Src: 00d0.59ab.7037
Authentication session statistics for interface port1.0.2
    session user name: manager
    session authentication method: Remote server
    session time: 19440 secs
    session terminate cause: Not terminated yet
Authentication Diagnostics for interface port1.0.2
    Supplicant address: 00d0.59ab.7037
    authEnterConnecting: 2
    authEaplogoffWhileConnecting: 1
    authEnterAuthenticating: 2
    authSuccessWhileAuthenticating: 1
    authTimeoutWhileAuthenticating: 1
    authFailWhileAuthenticating: 0
    authEapstartWhileAuthenticating: 0
```

Table 1: Example output from the **show dot1x all** command (cont.)

```
authEaplogoggWhileAuthenticating: 0
authReauthsWhileAuthenticated: 0
authEapstartWhileAuthenticated: 0
authEaplogoffWhileAuthenticated: 0
BackendResponses: 2
BackendAccessChallenges: 1
BackendOtherrequestToSupplicant: 3
BackendAuthSuccess: 1
BackendAuthFails: 0
```

Command changes Version 5.4.9-2.1: command added to AR2050V, AR3050S, and AR4050S

show dot1x diagnostics

Overview This command shows 802.1X authentication diagnostics for the specified interface (optional).

If no interface is specified then authentication diagnostics are shown for all interfaces.

For information on filtering and saving command output, see the [“Getting Started with AlliedWare Plus” Feature Overview and Configuration Guide](#).

Syntax `show dot1x diagnostics [interface <interface-list>]`

Parameter	Description
<code>interface</code>	Specify a port to show.
<code><interface-list></code>	The interfaces or ports to configure. An interface-list can be: <ul style="list-style-type: none">• a VLAN (e.g. vlan2)• a switchport (e.g. port1.0.4)• a continuous range of interfaces separated by a hyphen (e.g. port1.0.1-port1.0.3)• a comma-separated list (e.g. port1.0.1, port1.0.3-port1.0.4). Do not mix interface types in a list. The specified interfaces must exist.

Mode Privileged Exec

Example See the sample output below showing 802.1X authentication diagnostics for port1.0.2:

```
awplus# show dot1x diagnostics interface port1.0.2
```

Output Figure 40-1: Example output from the **show dot1x diagnostics** command

```
Authentication Diagnostics for interface port1.0.2
  Supplicant address: 00d0.59ab.7037
  authEnterConnecting: 2
  authEaplogoffWhileConnecting: 1
  authEnterAuthenticating: 2
  authSuccessWhileAuthenticating: 1
  authTimeoutWhileAuthenticating: 1
  authFailWhileAuthenticating: 0
  authEapstartWhileAuthenticating: 0
  authEaplogoggWhileAuthenticating: 0
  authReauthsWhileAuthenticated: 0
  authEapstartWhileAuthenticated: 0
  authEaplogoffWhileAuthenticated: 0
  BackendResponses: 2
  BackendAccessChallenges: 1
  BackendOtherrequestToSupplicant: 3
  BackendAuthSuccess: 1
```

Command changes Version 5.4.9-2.1: command added to AR2050V, AR3050S, and AR4050S

show dot1x interface

Overview Use this command to show the status of 802.1X port-based authentication on the specified interface.

For information on filtering and saving command output, see the [“Getting Started with AlliedWare_Plus” Feature Overview and Configuration Guide](#).

Syntax `show dot1x interface <interface-list>`

Parameter	Description
<code><interface-list></code>	The interfaces to display information about. An interface-list can be: <ul style="list-style-type: none">• a VLAN (e.g. vlan2)• a switchport (e.g. port1.0.4)• a continuous range of interfaces separated by a hyphen (e.g. port1.0.1-port1.0.3)• a comma-separated list (e.g. port1.0.1, port1.0.3-port1.0.4). Do not mix interface types in a list.

Mode Privileged Exec

Examples See the sample output below showing 802.1X authentication status for port1.0.2:

```
awplus# show dot1x interface port1.0.2
```

Table 2: Example output from the **show dot1x interface** command for a port

```
awplus#show dot1x interface port1.0.2
Authentication info for interface port1.0.2
  portEnabled: true - portControl: Auto
  portStatus: Authorized
  reAuthenticate: disabled
  reAuthPeriod: 3600
  PAE: quietPeriod: 60 - maxReauthReq: 2 - txPeriod: 30
  PAE: connectTimeout: 30
  BE: suppTimeout: 30 - serverTimeout: 30
  CD: adminControlledDirections: in
  KT: keyTxEnabled: false
  critical: disabled
  guestVlan: disabled
  dynamicVlanCreation: single-dynamic-vlan
    assignFailActionRule: deny
  multiVlanSession: disabled
  hostMode: multi-supplicant
    maxsupplicant: 1024
  dot1x: enabled
  protocolVersion: 1
  authMac: enabled
  method: PAP
  reauthRelearning: disabled
  authWeb: enabled
  method: PAP
  lockCount: 3
  packetForwarding: disabled
    twoStepAuthentication:
      configured: enabled
      actual: enabled
  supplicantMac: none
```

Related commands

- [show auth diagnostics](#)
- [show dot1x sessionstatistics](#)
- [show dot1x statistics interface](#)
- [show dot1x supplicant interface](#)

Command changes

Version 5.4.9-2.1: command added to AR2050V, AR3050S, and AR4050S

show dot1x sessionstatistics

Overview This command shows authentication session statistics for the specified interface, which may be a static channel (or static aggregator) or a dynamic (or LACP) channel group or a switch port.

For information on filtering and saving command output, see the [“Getting Started with AlliedWare Plus” Feature Overview and Configuration Guide](#).

Syntax `show dot1x sessionstatistics [interface <interface-list>]`

Parameter	Description
interface	Specify a port to show.
<interface-list>	The interfaces to display information about. An interface-list can be: <ul style="list-style-type: none">• a VLAN (e.g. vlan2)• a switchport (e.g. port1.0.4)• a continuous range of interfaces separated by a hyphen (e.g. port1.0.1-port1.0.3)• a comma-separated list (e.g. port1.0.1, port1.0.3-port1.0.4). Do not mix interface types in a list.

Mode Privileged Exec

Example See sample output below showing 802.1X authentication session statistics for port1.0.2:

```
awplus# show dot1x sessionstatistics interface port1.0.2
```

```
Authentication session statistics for interface port1.0.2
session user name: manager
session authentication method: Remote server
session time: 19440 secs
session terminat cause: Not terminated yet
```

Command changes Version 5.4.9-2.1: command added to AR2050V, AR3050S, and AR4050S

show dot1x statistics interface

Overview Use this command to show the authentication statistics for the specified interface. For information on filtering and saving command output, see the [“Getting Started with AlliedWare Plus” Feature Overview and Configuration Guide](#).

The output from this command is the same as the output from the [show auth statistics interface](#) command.

Syntax `show dot1x statistics interface <interface-list>`

Parameter	Description
<code><interface-list></code>	The interfaces to display information about. An interface-list can be: <ul style="list-style-type: none">• a VLAN (e.g. vlan2)• a switchport (e.g. port1.0.4)• a continuous range of interfaces separated by a hyphen (e.g. port1.0.1-port1.0.3)• a comma-separated list (e.g. port1.0.1, port1.0.3-port1.0.4). Do not mix interface types in a list.

Mode Privileged Exec

Example To display 802.1X authentication statistics for port1.0.2, use the command:

```
awplus# show dot1x statistics interface port1.0.2
```

Output Figure 40-2: Example output from **show dot1x statistics interface** for a port

```
awplus# show dot1x statistics interface port1.0.2
802.1X statistics for interface port1.0.2
  EAPOL Frames Rx: 5 - EAPOL Frames Tx: 16
  EAPOL Start Frames Rx: 0 - EAPOL Logoff Frames Rx: 0
  EAP Rsp/Id Frames Rx: 3 - EAP Response Frames Rx: 2
  EAP Req/Id Frames Tx: 8 - EAP Request Frames Tx: 2
  Invalid EAPOL Frames Rx: 0 - EAP Length Error Frames Rx: 0
  EAPOL Last Frame Version Rx: 1 - EAPOL Last Frame
Src:00d0.59ab.7037
```

Command changes Version 5.4.9-2.1: command added to AR2050V, AR3050S, and AR4050S

show dot1x supplicant

Overview This command shows the supplicant state of the authentication mode set for the switch.

This command shows a summary when the optional **brief** parameter is used.

For information on filtering and saving command output, see the [“Getting Started with AlliedWare_Plus” Feature Overview and Configuration Guide](#).

Syntax show dot1x supplicant [<macadd>] [brief]

Parameter	Description
<macadd>	MAC (hardware) address of the Supplicant.
brief	Brief summary of the Supplicant state.

Mode Privileged Exec

Example See sample output below showing the 802.1X authenticated supplicant on the switch:

```
awplus# show dot1x supplicant
```

```
authenticationMethod: dot1x
totalSupplicantNum: 1
authorizedSupplicantNum: 1
macBasedAuthenticationSupplicantNum: 0
dot1xAuthenticationSupplicantNum: 1
webBasedAuthenticationSupplicantNum: 0
Supplicant name: manager
Supplicant address: 00d0.59ab.7037
  authenticationMethod: dot1x
    Two-Step Authentication:
      firstAuthentication: Pass - Method: mac
      secondAuthentication: Pass - Method: dot1x
portStatus: Authorized - currentId: 4
abort:F fail:F start:F timeout:F success:T
PAE: state: Authenticated - portMode: Auto
PAE: reAuthCount: 0 - rxRespId: 0
PAE: quietPeriod: 60 - maxReauthReq: 2 - txPeriod: 30
BE: state: Idle - reqCount: 0 - idFromServer: 3
BE: suppTimeout: 30 - serverTimeout: 30
CD: adminControlledDirections: in - operControlledDirections: in
CD: bridgeDetected: false
KR: rxKey: false
KT: keyAvailable: false - keyTxEnabled: false
RADIUS server group (auth): radius
RADIUS server (auth): 192.168.1.40
```

See sample output below showing the supplicant on the switch using the **brief** parameter:

```
awplus# show dot1x supplicant 00d0.59ab.7037 brief
```

```
Interface port1.0.2
 authenticationMethod: dot1x
 totalSupplicantNum: 1
 authorizedSupplicantNum: 1
   macBasedAuthenticationSupplicantNum: 0
   dot1xAuthenticationSupplicantNum: 1
   webBasedAuthenticationSupplicantNum: 0
```

Interface	VID	Mode	MAC Address	Status	IP Address	Username
port1.0.2	2	D	00d0.59ab.7037	Authenticated	192.168.2.201	manager

See sample output below showing the supplicant on the switch using the **brief** parameter:

```
awplus# show dot1x supplicant brief
```

For example, if two-step authentication is configured with 802.1X authentication as the first method and web authentication as the second method then the output is as follows:

```
Interface port1.0.2 authenticationMethod: dot1x/web
 Two-Step Authentication
   firstMethod: dot1x
   secondMethod: web
 totalSupplicantNum: 1
 authorizedSupplicantNum: 1
   macBasedAuthenticationSupplicantNum: 0
   dot1xAuthenticationSupplicantNum: 0
   webBasedAuthenticationSupplicantNum: 1
   otherAuthenticationSupplicantNum: 0
```

Interface	VID	Mode	MAC Address	Status	IP Address	Username
port1.0.2	5	W	0008.0d5e.c216	Authenticated	192.168.1.200	web

Related commands [show dot1x supplicant interface](#)

Command changes Version 5.4.9-2.1: command added to AR2050V, AR3050S, and AR4050S

show dot1x supplicant interface

Overview Use this command to show the supplicant state of the authentication mode set for the interface.

This command shows a summary when the optional **brief** parameter is used.

For information on filtering and saving command output, see the [“Getting Started with AlliedWare_Plus” Feature Overview and Configuration Guide](#).

Syntax show dot1x supplicant interface <interface-list> [brief]

Parameter	Description
<interface-list>	The interfaces to display information about. An interface-list can be: <ul style="list-style-type: none">• a VLAN (e.g. vlan2)• a switchport (e.g. port1.0.4)• a continuous range of interfaces separated by a hyphen (e.g. port1.0.1-port1.0.3)• a comma-separated list (e.g. port1.0.1, port1.0.3-port1.0.4). Do not mix interface types in a list.
brief	Brief summary of the Supplicant state.

Mode Privileged Exec

Examples See sample output below showing the supplicant on the interface port1.0.2:

```
awplus# show dot1x supplicant interface port1.0.2
```

```
Interface port1.0.2
 authenticationMethod: dot1x
  totalSupplicantNum: 1
 authorizedSupplicantNum: 1
   macBasedAuthenticationSupplicantNum: 0
   dot1xAuthenticationSupplicantNum: 1
   webBasedAuthenticationSupplicantNum: 0
   otherAuthenticationSupplicantNum: 0

Supplicant name: VCSPCVLAN10
Supplicant address: 0000.cd07.7b60
 authenticationMethod: 802.1X
Two-Step Authentication:
 firstAuthentication: Pass - Method: mac
 secondAuthentication: Pass - Method: dot1x
 portStatus: Authorized - currentId: 3
 abort:F fail:F start:F timeout:F success:T
 PAE: state: Authenticated - portMode: Auto
 PAE: reAuthCount: 0 - rxRespId: 0
 PAE: quietPeriod: 60 - maxReauthReq: 2
 BE: state: Idle - reqCount: 0 - idFromServer: 2
 CD: adminControlledDirections:in -
 operControlledDirections:in
 CD: bridgeDetected: false
 KR: rxKey: false
 KT: keyAvailable: false - keyTxEnabled: false
```

See sample output below showing the supplicant on the switch using the **brief** parameter:

```
awplus# show dot1x supplicant interface port1.0.2 brief
```

```
Interface port1.0.2
 authenticationMethod: dot1x
Two-Step Authentication:
 firstMethod: mac
 secondMethod: dot1x
totalSupplicantNum: 1
authorizedSupplicantNum: 1
macBasedAuthenticationSupplicantNum: 0
dot1xAuthenticationSupplicantNum: 1
webBasedAuthenticationSupplicantNum: 0

Interface  VID  Mode  MAC Address      Status      IP Address      Username
=====  ===  ====  =====
port1.0.2  2    D     00d0.59ab.7037  Authenticated  192.168.2.201  manager
```

Related commands [show dot1x supplicant](#)

Command changes Version 5.4.9-2.1: command added to AR2050V, AR3050S, and AR4050S

undebbug dot1x

Overview This command applies the functionality of the **no** variant of the [debug dot1x](#) command.

41

Authentication Commands

Introduction

Overview The AR2050V supports port authentication with the following limitations:

- MAC authentication is supported on the device's switch ports static channel-groups and dynamic (LACP) channel-groups.
- 802.1X authentication is supported on the device's switch ports only. It is not supported on static channel-groups and dynamic (LACP) channel-groups.
- Web authentication is supported on the device's Eth interfaces only.

This chapter provides an alphabetical reference for MAC and web authentication commands. For a list of 802.1X commands see the [802.1X Commands](#) chapter.

For more information on configuring and using port authentication, see the [AAA and Port Authentication Feature Overview and Configuration Guide](#).

- Command List**
- ["auth auth-fail vlan"](#) on page 2108
 - ["auth critical"](#) on page 2110
 - ["auth dhcp-framed-ip-lease"](#) on page 2111
 - ["auth dynamic-vlan-creation"](#) on page 2113
 - ["auth guest-vlan"](#) on page 2115
 - ["auth guest-vlan forward"](#) on page 2117
 - ["auth host-mode"](#) on page 2119
 - ["auth log"](#) on page 2121
 - ["auth max-supplicant"](#) on page 2123
 - ["auth max-supplicant tagged-vlan"](#) on page 2125
 - ["auth max-supplicant untagged-vlan"](#) on page 2127
 - ["auth multi-vlan-session"](#) on page 2129
 - ["auth priority"](#) on page 2130

- [“auth profile \(global\)”](#) on page 2132
- [“auth profile \(interface\)”](#) on page 2133
- [“auth reauthentication”](#) on page 2134
- [“auth roaming disconnected”](#) on page 2135
- [“auth roaming enable”](#) on page 2137
- [“auth supplicant-ip”](#) on page 2139
- [“auth supplicant-mac”](#) on page 2141
- [“auth timeout connect-timeout”](#) on page 2144
- [“auth timeout quiet-period”](#) on page 2146
- [“auth timeout reauth-period”](#) on page 2147
- [“auth timeout server-timeout”](#) on page 2149
- [“auth timeout supp-timeout”](#) on page 2151
- [“auth vlan-restriction”](#) on page 2152
- [“auth two-step enable”](#) on page 2154
- [“auth two-step order”](#) on page 2156
- [“auth-mac accounting”](#) on page 2158
- [“auth-mac authentication”](#) on page 2159
- [“auth-mac enable”](#) on page 2160
- [“auth-mac method”](#) on page 2162
- [“auth-mac password”](#) on page 2164
- [“auth-mac reauth-relearning”](#) on page 2165
- [“auth-mac static”](#) on page 2166
- [“auth-mac username”](#) on page 2167
- [“auth-web accounting”](#) on page 2168
- [“auth-web authentication”](#) on page 2169
- [“auth-web enable”](#) on page 2170
- [“auth-web forward”](#) on page 2172
- [“auth-web idle-timeout enable”](#) on page 2175
- [“auth-web idle-timeout timeout”](#) on page 2176
- [“auth-web max-auth-fail”](#) on page 2177
- [“auth-web method”](#) on page 2179
- [“auth-web-server dhcp ipaddress”](#) on page 2180
- [“auth-web-server dhcp lease”](#) on page 2182
- [“auth-web-server dhcp-wpad-option”](#) on page 2183
- [“auth-web-server host-name”](#) on page 2184

- [“auth-web-server intercept-port”](#) on page 2185
- [“auth-web-server ip-conflict-prefer-newer-supplciant”](#) on page 2186
- [“auth-web-server ipaddress”](#) on page 2187
- [“auth-web-server page language”](#) on page 2188
- [“auth-web-server login-url”](#) on page 2189
- [“auth-web-server page logo”](#) on page 2190
- [“auth-web-server page sub-title”](#) on page 2191
- [“auth-web-server page success-message”](#) on page 2192
- [“auth-web-server page title”](#) on page 2193
- [“auth-web-server page welcome-message”](#) on page 2194
- [“auth-web-server ping-poll enable”](#) on page 2195
- [“auth-web-server ping-poll failcount”](#) on page 2196
- [“auth-web-server ping-poll interval”](#) on page 2197
- [“auth-web-server ping-poll reauth-timer-refresh”](#) on page 2198
- [“auth-web-server ping-poll timeout”](#) on page 2199
- [“auth-web-server ping-poll type”](#) on page 2200
- [“auth-web-server port”](#) on page 2202
- [“auth-web-server redirect-delay-time”](#) on page 2203
- [“auth-web-server redirect-url”](#) on page 2204
- [“auth-web-server session-keep”](#) on page 2205
- [“auth-web-server ssl”](#) on page 2206
- [“auth-web-server ssl intercept-port”](#) on page 2207
- [“auth-web-server trustpoint”](#) on page 2208
- [“copy proxy-autoconfig-file”](#) on page 2210
- [“copy web-auth-https-file”](#) on page 2211
- [“description \(auth-profile\)”](#) on page 2212
- [“erase proxy-autoconfig-file”](#) on page 2213
- [“erase web-auth-https-file”](#) on page 2214
- [“show auth”](#) on page 2215
- [“show auth diagnostics”](#) on page 2216
- [“show auth interface”](#) on page 2217
- [“show auth sessionstatistics”](#) on page 2219
- [“show auth statistics interface”](#) on page 2220
- [“show auth supplciant”](#) on page 2221
- [“show auth supplciant interface”](#) on page 2224

- [“show auth two-step supplicant brief”](#) on page 2225
- [“show auth-web-server”](#) on page 2227
- [“show auth-web-server page”](#) on page 2228
- [“show proxy-autoconfig-file”](#) on page 2229

auth auth-fail vlan

Overview Use this command to enable the **auth-fail vlan** feature on the specified vlan interface. This feature assigns supplicants (client devices) to the specified VLAN if they fail port authentication.

Use the **no** variant of this command to disable the auth-fail vlan feature for a specified VLAN interface.

Syntax `auth auth-fail vlan <1-4094>`
`no auth auth-fail vlan`

Parameter	Description
<1-4094>	Assigns the VLAN ID to any supplicants that have failed port authentication.

Default The auth-fail vlan feature is disabled by default.

Mode Interface Configuration for a static channel, a dynamic (LACP) channel group, or a switch port; or Authentication Profile mode.

Usage notes Use the auth-fail vlan feature when using web authentication instead of the Guest VLAN feature, when you need to separate networks where one supplicant (client device) requires authentication and another supplicant does not require authentication from the same interface.

This is because the DHCP lease time using the Web-Authentication feature is shorter, and the auth-fail vlan feature enables assignment to a different VLAN if a supplicant fails authentication.

To enable the auth-fail vlan feature with web authentication, you need to set the web authentication server virtual IP address by using the `auth-web-server ipaddress` command or the `auth-web-server dhcp ipaddress` command.

When using 802.1X port authentication, use a `dot1x max-auth-fail` command to set the maximum number of login attempts. Three login attempts are allowed by default for 802.1X port authentication before supplicants trying to authenticate are moved from the Guest VLAN to the auth-fail VLAN. See the `dot1x max-auth-fail` on page 2082 for command information.

See the [AAA and Port Authentication Feature Overview and Configuration Guide](#) for information about:

- the auth-fail VLAN feature, which allows the Network Administrator to separate the supplicants who attempted authentication, but failed, from the supplicants who did not attempt authentication, and
- restrictions regarding combinations of authentication enhancements working together

Examples To enable the auth-fail vlan feature for port1.0.2 and assign VLAN 100, use the following commands:

```
awplus# configure terminal
awplus(config)# interface port1.0.2
awplus(config-if)# auth auth-fail vlan 100
```

To disable the auth-fail vlan feature for port1.0.2, use the following commands:

```
awplus# configure terminal
awplus(config)# interface port1.0.2
awplus(config-if)# no auth auth-fail vlan
```

Related commands

- auth profile (global)
- dot1x max-auth-fail
- show dot1x
- show dot1x interface
- show running-config

Command changes Version 5.4.9-2.1: command added to AR2050V, AR3050S, and AR4050S

auth critical

Overview Use this command to enable the critical port feature on the interface. When the critical port feature is enabled on an interface, and all the RADIUS servers are unavailable, then the interface becomes authorized.

The **no** variant of this command disables the critical port feature on the interface.

Syntax `auth critical`
`no auth critical`

Default The critical port of port authentication is disabled.

Mode `auth-web`: Interface Configuration for an Eth interface, or Authentication Profile mode.
`auth-mac`: Interface Configuration for a static channel, a dynamic (LACP) channel group, or a switch port; or Authentication Profile mode.
`dot1x`: Interface Configuration for a switch port; or Authentication Profile mode.

Examples To enable the critical port feature on interface eth1, use the following commands:

```
awplus# configure terminal
awplus(config)# interface eth1
awplus(config-if)# auth critical
```

To disable the critical port feature on interface eth1, use the following commands:

```
awplus# configure terminal
awplus(config)# interface eth1
awplus(config-if)# no auth critical
```

To enable the critical port feature on authentication profile 'student', use the commands:

```
awplus# configure terminal
awplus(config)# auth profile student
awplus(config-auth-profile)# auth critical
```

Related commands

- [auth profile \(global\)](#)
- [show auth-web-server](#)
- [show dot1x](#)
- [show dot1x interface](#)
- [show running-config](#)

auth dhcp-framed-ip-lease

Overview Use this command to enable DHCP Framed IP Lease on an interface.

When the DHCP Framed IP Lease feature is enabled on an interface, supplicants authenticated using 802.1x or MAC authentication will be assigned a specific IP address, and other network settings, gathered from the RADIUS server during the authentication process.

Use the **no** variant of this command to disable DHCP Framed IP Lease.

Syntax `auth dhcp-framed-ip-lease`
`no auth dhcp-framed-ip-lease`

Default DHCP Framed IP Lease is disabled by default.

Mode Interface Configuration for a static channel, a dynamic (LACP) channel group, or a switch port; or Authentication Profile mode.

Usage notes You need to complete the following steps to configure the DHCP Framed IP Lease feature on your network.

On the RADIUS server:

- Configure the RADIUS server with the username and password for 802.1x or MAC authentication
- Configure the following 'framed' RADIUS attributes on the RADIUS server for the that user:
 - Framed-IP-Address (8): the IPv4 address for the supplicant
 - Framed-IP-Netmask (9): the netmask for the supplicant
 - Framed-Route (22): the default gateway IPv4 address for the supplicant
 - Session-Timeout (27): IP address lease time for the supplicant

NOTE: *The Frame-IP-Address (8) attribute must be configured for this feature to work. All other attributes are optional.*

On the DHCP server:

- Configure the RADIUS client
- Enable 802.1x or MAC authentication on the required interface/s
- Enable DHCP Framed IP Lease feature on the required interface/s
- Setup a DHCP pool with the network range for the IP address/es registered on the RADIUS server
- Enable DHCP server

For more information, see the [AAA and Port Authentication Feature Overview and Configuration Guide](#).

Example To enable DHCP Framed IP Lease on port1.0.1, use the commands:

```
awplus# configure terminal
awplus(config)# interface port1.0.1
awplus(config-if)# auth dhcp-framed-ip-lease
```

To disable DHCP Framed IP Lease on port1.0.1, use the commands:

```
awplus# configure terminal
awplus(config)# interface port1.0.1
awplus(config-if)# no auth dhcp-framed-ip-lease
```

Related commands [show dot1x supplicant](#)
[show ip dhcp pool](#)

Command changes Version 5.4.8-2.1: command added

auth dynamic-vlan-creation

Overview Use this command to enable and disable the Dynamic VLAN assignment feature.

The Dynamic VLAN assignment feature allows a supplicant (client device) to be placed into a specific VLAN based on information returned from the RADIUS server during authentication, on a given interface.

Use the **no** variant of this command to disable the Dynamic VLAN assignment feature.

Syntax `auth dynamic-vlan-creation [rule {deny|permit}]`
`no auth dynamic-vlan-creation`

Parameter	Description
<code>rule</code>	VLAN assignment rule.
<code>deny</code>	Deny a differently assigned VLAN ID. This is the default rule.
<code>permit</code>	Permit a differently assigned VLAN ID.

Default By default, the Dynamic VLAN assignment feature is disabled.

Mode Interface Configuration for a static channel, a dynamic (LACP) channel group, or a switch port; or Authentication Profile mode.

Usage notes If the Dynamic VLAN assignment feature is enabled (disabled by default), VLAN assignment is dynamic. If the Dynamic VLAN assignment feature is disabled then RADIUS attributes are ignored and configured VLANs are assigned to ports.

The optional **rule** parameter specifies the VLAN assignment rule when the second supplicant's VLAN ID is different from VLAN ID from the first supplicant. If the **deny** value is applied with the command then the second supplicant with a different VLAN ID is rejected. If the **permit** value is applied with the command then the second supplicant with a different VLAN ID is accepted and assigned to the first supplicant's VLAN.

If you issue an **auth dynamic-vlan-creation** command without a **rule** parameter then a second supplicant with a different VLAN ID is rejected. It is not assigned to the first supplicant's VLAN. Issuing an **auth dynamic-vlan-creation** command without a **rule** parameter has the same effect as issuing an **auth dynamic-vlan-creation rule deny** command rejecting supplicants with differing VLANs.

Examples To enable the Dynamic VLAN assignment feature on interface port1.0.2, use the commands:

```
awplus# configure terminal
awplus(config)# interface port1.0.2
awplus(config-if)# switchport access vlan 10
awplus(config-if)# auth-web enable
awplus(config-if)# auth dynamic-vlan-creation
awplus(config-if)# interface vlan10
awplus(config-if)# ip address 10.1.1.1/24
```

To enable the Dynamic VLAN assignment feature with Web Authentication on interface port1.0.2 when Web Authentication is needed, use the commands:

```
awplus# configure terminal
awplus(config)# auth-web-server ipaddress 1.2.3.4
awplus(config)# access-list hardware acl-web send-to-cpu ip any
1.2.3.4
awplus(config)# interface port1.0.2
awplus(config-if)# auth-web enable
awplus(config-if)# auth dynamic-vlan-creation
awplus(config-if)# access-group acl-web
awplus(config-if)# interface vlan1
awplus(config-if)# ip address 10.1.1.1/24
```

To disable the Dynamic VLAN assignment feature on interface port1.0.2, use the commands:

```
awplus# configure terminal
awplus(config)# interface port1.0.2
awplus(config-if)# no auth dynamic-vlan-creation
```

To enable the Dynamic VLAN assignment feature on authentication profile 'student', use the commands:

```
awplus# configure terminal
awplus(config)# auth profile student
awplus(config-auth-profile)# auth dynamic-vlan-creation
```

Related commands

- [auth profile \(global\)](#)
- [auth host-mode](#)
- [show dot1x](#)
- [show dot1x interface](#)
- [show running-config](#)

Command changes Version 5.4.9-2.1: command added to AR2050V, AR3050S, and AR4050S

auth guest-vlan

Overview Use this command to enable and configure the Guest VLAN feature on the interface specified by associating a Guest VLAN with an interface. This command does not start authentication. The supplicant's (client device's) traffic is associated with the native VLAN of the interface unless it is already associated with another VLAN. The **routing** option enables routing from the Guest VLAN to another VLAN, so the switch can lease DHCP addresses and accept access to a limited network.

The **no** variant of this command disables the guest VLAN feature on the interface specified.

Syntax `auth guest-vlan <1-4094> [routing]`
`no auth guest-vlan [routing]`

Parameter	Description
<1-4094>	VLAN ID (VID).
routing	Enables routing from the Guest VLAN to other VLANs.

Default The Guest VLAN authentication feature is disabled by default.

Mode Interface Configuration for a static channel, a dynamic (LACP) channel group, or a switch port; or Authentication Profile mode.

Usage notes The Guest VLAN feature may be used by supplicants (client devices) that have not attempted authentication, or have failed the authentication process. Note that if a port is in multi-supplicant mode with per-port dynamic VLAN configuration, after the first successful authentication, subsequent hosts cannot use the guest VLAN due to the change in VLAN ID. This may be avoided by using per-user dynamic VLAN assignment.

When using the Guest VLAN feature with the multi-host mode, a number of supplicants can communicate via a guest VLAN before authentication. A supplicant's traffic is associated with the native VLAN of the specified switch port. The supplicant must belong to a VLAN before traffic from the supplicant can be associated.

Note that you must enable 802.1X on the port and define a VLAN using the [vlan](#) command before you can configure it as a guest VLAN.

Note that Guest VLAN can use only untagged ports.

See the [AAA and Port Authentication Feature Overview and Configuration Guide](#) for information about:

- Guest VLAN, and
- restrictions regarding combinations of authentication enhancements working together

Examples To define vlan100 and assign the guest VLAN feature to vlan100 on interface port1.0.2, and enable routing from the guest VLAN to other VLANs, use the following commands:

```
awplus# configure terminal
awplus(config)# vlan database
awplus(config-vlan)# vlan 100
awplus(config-vlan)# exit
awplus(config)# interface port1.0.2
awplus(config-if)# dot1x port-control auto
awplus(config-if)# auth guest-vlan 100 routing
```

To disable the guest VLAN feature on port1.0.2, use the following commands:

```
awplus# configure terminal
awplus(config)# interface port1.0.2
awplus(config-if)# no auth guest-vlan
```

To define vlan100 and assign the guest VLAN feature to vlan100 on authentication profile 'student', use the commands:

```
awplus# configure terminal
awplus(config)# vlan database
awplus(config-vlan)# vlan 100
awplus(config-vlan)# exit
awplus(config)# auth profile student
awplus(config-auth-profile)# auth guest-vlan 100
```

Related commands

- [auth profile \(global\)](#)
- [auth guest-vlan forward](#)
- [dot1x port-control](#)
- [show dot1x](#)
- [show dot1x interface](#)

Command changes Version 5.4.9-2.1: command added to AR2050V, AR3050S, and AR4050S

auth guest-vlan forward

Overview Use this command to enable packet forwarding from the guest VLAN to a destination IP address or subnet. If this command is configured, the device can lease DHCP addresses and accept access to a limited part of your network. Also, when using NAP authentication, the supplicant can log on to a domain controller to gain certification.

Use the **no** variant of this command to disable packet forwarding from the Guest VLAN to a destination IP address or subnet.

Syntax `auth guest-vlan forward {<ip-address>|<ip-address/mask>} [dns|tcp <1-65535>|udp <1-65535>]`
`no auth guest-vlan forward {<ip-address>|<ip-address/mask>} [dns|tcp <1-65535>|udp <1-65535>]`

Parameter	Description
<code><ip-address></code> <code><ip-address/mask></code>	The IP address or subnet to which the guest VLAN can forward packets, in dotted decimal notation
<code>dns</code>	Enable forwarding of DNS packets
<code>tcp <1-65535></code>	Enable forwarding of packets for the specified TCP port number
<code>udp <1-65535></code>	Enable forwarding of packets for the specified UDP port number

Default Forwarding is disabled by default.

Mode Interface Configuration mode for a specified switch port, or Authentication Profile mode

Usage Before using this command, you must configure the guest VLAN with the [auth guest-vlan](#) command.

Example To enable packet forwarding from the guest VLAN to the destination IP address on interface port1.0.2, use the commands:

```
awplus# configure terminal
awplus(config)# interface port1.0.2
awplus(config-if)# auth guest-vlan forward 10.0.0.1
```

To enable forwarding of DNS packets from the guest VLAN to the destination IP address on interface port1.0.2, use the commands:

```
awplus# configure terminal
awplus(config)# interface
awplus(config-if)# auth guest-vlan forward 10.0.0.1 dns
```

To disable forwarding of DNS packets from the guest VLAN to the destination IP address on port1.0.2, use the commands:

```
awplus# configure terminal
awplus(config)# interface port1.0.2
awplus(config-if)# no auth guest-vlan forward 10.0.0.1 dns
```

To enable the TCP forwarding port 137 on authentication profile 'student', use the commands:

```
awplus# configure terminal
awplus(config)# auth profile student
awplus(config-auth-profile)# auth guest-vlan forward 10.0.0.1
tcp 137
```

**Related
commands**

[auth guest-vlan](#)
[auth profile \(global\)](#)
[show running-config](#)

**Command
changes**

Version 5.4.9-2.1: command added to AR2050V, AR3050S, and AR4050S

auth host-mode

Overview Use this command to select the host mode on the specified interface.

Use the **no** variant of this command to set host mode to the default setting (single host).

Syntax

```
auth host-mode  
{host-plus-voice|single-host|multi-host|multi-supPLICANT}  
  
no auth host-mode
```

Parameter	Description
host-plus-voice	In this mode, only one voice device (IP phone) and one host device can join the network. You use the RADIUS attribute 'Cisco-AVPair device-traffic-class=voice' to identify the IP phone. For more information and a step-by-step configuration example, see the "Limit the number of supplicants when connecting via an IP phone" section of the AAA and Port Authentication Feature Overview and Configuration Guide .
single-host	In this mode, only one supplicant is allowed per port. This is the default mode.
multi-host	In this mode, once the first host on a port is authenticated, all other downstream hosts are allowed without being authenticated (piggy-back mode).
multi-supPLICANT	In this mode, multiple separate supplicants are individually authenticated on one port.

Default The default host mode for port authentication is for a single host.

Mode

- auth-web: Interface Configuration for an Eth interface, or Authentication Profile mode.
- auth-mac: Interface Configuration for a static channel, a dynamic (LACP) channel group, or a switch port; or Authentication Profile mode.
- dot1x: Interface Configuration for a switch port; or Authentication Profile mode.

Usage notes **Single-host mode**

With this mode, only one supplicant may be authenticated on the port. Once that host has been authenticated, no other supplicants may be authenticated until the first supplicant's session has closed. This means, of course, that none of the other hosts downstream of the port will be able to send or receive traffic on that port.

This option is recommended when you know that there should only be one host connected to a port. By limiting the port to a single authenticated host, you guard against the consequences of someone accidentally or maliciously connecting a downstream switch to the port.

Multi-host mode

With this mode, once the first host has been authenticated on the port, all other downstream hosts are allowed without being authenticated. This is sometimes known as piggy-back mode. It is useful when the downstream switch attached to the authenticating port is an intelligent switch that can act as an authentication supplicant.

If you trust that malicious users cannot be connected to that switch but you do not know the identity of those users, then you can simply authenticate the switch and then allow its attached users to have network access. If the valid switch is disconnected and an invalid one is connected which is not configured with the correct authentication credentials, then the devices connected to the invalid switch will be blocked from accessing the network.

Examples To set the host mode to multi-supplicant on interface port1.0.2, use the following commands:

```
awplus# configure terminal
awplus(config)# interface port1.0.2
awplus(config-if)# auth host-mode multi-supplicant
```

To set the host mode to the default (single host) on interface port1.0.2, use the following commands:

```
awplus# configure terminal
awplus(config)# interface port1.0.2
awplus(config-if)# no auth host-mode
```

To set the host mode to multi-supplicant on authentication profile 'student', use the commands:

```
awplus# configure terminal
awplus(config)# auth profile student
awplus(config-auth-profile)# auth host-mode multi-supplicant
```

To set the host mode to the default (single host) on authentication profile 'student', use the commands:

```
awplus# configure terminal
awplus(config)# auth profile student
awplus(config-auth-profile)# no auth host-mode
```

Related commands [auth profile \(global\)](#)

[show dot1x](#)

[show dot1x interface](#)

[show running-config](#)

Command changes Version 5.5.2-1.1: **host-plus-voice** parameter added

auth log

Overview Use this command to configure the types of authentication feature log messages that are output to the log file.

Use the **no** variant of this command to remove either specified types or all types of authentication feature log messages that are output to the log file.

Syntax

```
auth log {dot1x|auth-mac|auth-web}  
{success|failure|logoff|all}  
  
no auth log {dot1x|auth-mac|auth-web}  
{success|failure|logoff|all}
```

Parameter	Description
dot1x	Specify only 802.1X-Authentication log messages are output to the log file.
auth-mac	Specify only MAC-Authentication log messages are output to the log file.
auth-web	Specify only Web-Authentication log messages are output to the log file.
success	Specify only successful authentication log messages are output to the log file.
failure	Specify only authentication failure log messages are output to the log file.
logoff	Specify only authentication log-off messages are output to the log file. Note that link down, age out and expired ping polling messages will be included.
all	Specify all types of authentication log messages are output to the log file. Note that this is the default behavior for the authentication logging feature.

Default All types of authentication log messages are output to the log file by default.

Mode

- auth-web: Interface Configuration for an Eth interface, or Authentication Profile mode.
- auth-mac: Interface Configuration for a static channel, a dynamic (LACP) channel group, or a switch port; or Authentication Profile mode.
- dot1x: Interface Configuration for a switch port; or Authentication Profile mode.

Examples To configure the logging of web authentication failures to the log file for supplicants (client devices) connected to interface eth1, use the following commands:

```
awplus# configure terminal  
awplus(config)# interface eth1  
awplus(config-if)# auth log auth-web failure
```

To configure the logging of web authentication failures to the log file for supplicants (client devices) connected to authentication profile 'student', use the commands:

```
awplus# configure terminal
awplus(config)# auth profile student
awplus(config-auth-profile)# auth log auth-web failure
```

To disable the logging of all types of authentication log messages to the log file for auth-mac supplicants (client devices) connected to authentication profile 'student', use the commands:

```
awplus# configure terminal
awplus(config)# auth profile student
awplus(config-auth-profile)# no auth log auth-mac all
```

Related commands

- [auth profile \(global\)](#)
- [show running-config](#)

auth max-supPLICANT

Overview Use this command to set the maximum number of supplicants (client devices) that can be authenticated on the selected port. Once this value is exceeded, further supplicants will not be authenticated.

The **no** variant of this command resets the maximum supplicant number to the default.

Syntax `auth max-supPLICANT <2-1024>`
`no auth max-supPLICANT`

Parameter	Description
<2-1024>	Limit number.

Default 1024

Mode `auth-web`: Interface Configuration for an Eth interface, or Authentication Profile mode.
`auth-mac`: Interface Configuration for a static channel, a dynamic (LACP) channel group, or a switch port; or Authentication Profile mode.
`dot1x`: Interface Configuration for a switch port; or Authentication Profile mode.

Examples To set the maximum number of supplicants to 10 on interface eth1, use the following commands:

```
awplus# configure terminal
awplus(config)# interface eth1
awplus(config-if)# auth max-supPLICANT 10
```

To reset the maximum number of supplicants to the default value on interface eth1, use the following commands:

```
awplus# configure terminal
awplus(config)# interface eth1
awplus(config-if)# no auth max-supPLICANT
```

To set the maximum number of supplicants to 10 on authentication profile 'student', use the commands:

```
awplus# configure terminal
awplus(config)# auth profile student
awplus(config-auth-profile)# auth max-supPLICANT 10
```

To reset the maximum number of supplicants to the default value on authentication profile 'student', use the commands:

```
awplus# configure terminal
awplus(config)# auth profile student
awplus(config-auth-profile)# no auth max-supPLICANT
```

**Related
commands**

[auth max-supPLICANT tagged-vlan](#)
[auth max-supPLICANT untagged-vlan](#)
[auth profile \(global\)](#)
[show dot1x](#)
[show dot1x interface](#)
[show running-config](#)

auth max-suppliant tagged-vlan

Overview Use this command to set the maximum number of supplicants (client devices) that can be authenticated on the selected port on tagged VLANs. Once this value is exceeded, further supplicants will not be authenticated on tagged VLANs on that port.

This command is useful for preventing unwanted supplicants from connecting to the network when a host (e.g. a PC) connects to an AlliedWare Plus NAS via an IP phone. For more information and a step-by-step configuration example, see the [“Limit the number of supplicants when connecting via an IP phone”](#) section of the [AAA and Port Authentication Feature Overview and Configuration Guide](#).

Use the **no** variant of this command to reset the maximum number of supplicants on tagged VLANs to the default.

Syntax `auth max-suppliant tagged-vlan <0-1024>`
`no auth max-suppliant tagged-vlan <0-1024>`

Default 1024

Mode Interface Configuration for a switch port; or Authentication Profile mode.

Examples To set the maximum number of supplicants on tagged VLANs on interface port1.0.2 to 1, use the following commands:

```
awplus# configure terminal
awplus(config)# interface port1.0.2
awplus(config-if)# auth max-suppliant tagged-vlan 1
```

To reset the maximum number of supplicants on tagged VLANs on interface port1.0.2 to the default, use the following commands:

```
awplus# configure terminal
awplus(config)# interface port1.0.2
awplus(config-if)# no auth max-suppliant tagged-vlan
```

To set the maximum number of supplicants on tagged VLANs on authentication profile 'accounts' to 1, use the commands:

```
awplus# configure terminal
awplus(config)# auth profile accounts
awplus(config-auth-profile)# auth max-suppliant tagged-vlan 1
```

To reset the maximum number of supplicants on tagged VLANs on authentication profile 'accounts' to the default value, use the commands:

```
awplus# configure terminal
awplus(config)# auth profile accounts
awplus(config-auth-profile)# no auth max-suppliant tagged-vlan
```

Related commands `auth max-suplicant`
`auth max-suplicant untagged-vlan`

Command changes Version 5.5.2-1.1: command added

auth max-suppliant untagged-vlan

Overview Use this command to set the maximum number of supplicants (client devices) that can be authenticated on the selected port on untagged VLANs. Once this value is exceeded, further supplicants will not be authenticated on untagged VLANs on that port.

This command is useful for preventing unwanted supplicants from connecting to the network when a host (e.g. a PC) connects to an AlliedWare Plus NAS via an IP phone. For more information and a step-by-step configuration example, see the [“Limit the number of supplicants when connecting via an IP phone”](#) section of the [AAA and Port Authentication Feature Overview and Configuration Guide](#).

Use the **no** variant of this command to reset the maximum number of supplicants on untagged VLANs to the default.

Syntax `auth max-suppliant untagged-vlan <0-1024>`
`no auth max-suppliant untagged-vlan <0-1024>`

Default 1024

Mode Interface Configuration for a switch port; or Authentication Profile mode.

Examples To set the maximum number of supplicants on untagged VLANs on interface port1.0.2 to 1, use the following commands:

```
awplus# configure terminal
awplus(config)# interface port1.0.2
awplus(config-if)# auth max-suppliant untagged-vlan 1
```

To reset the maximum number of supplicants on untagged VLANs on interface port1.0.2 to the default, use the following commands:

```
awplus# configure terminal
awplus(config)# interface port1.0.2
awplus(config-if)# no auth max-suppliant untagged-vlan
```

To set the maximum number of supplicants on untagged VLANs on authentication profile 'accounts' to 1, use the commands:

```
awplus# configure terminal
awplus(config)# auth profile accounts
awplus(config-auth-profile)# auth max-suppliant untagged-vlan 1
```

To reset the maximum number of supplicants on untagged VLANs on authentication profile 'accounts' to the default value, use the commands:

```
awplus# configure terminal
awplus(config)# auth profile accounts
awplus(config-auth-profile)# no auth max-suppliant untagged-vlan
```

Related commands [auth max-suplicant](#)
[auth max-suplicant tagged-vlan](#)

Command changes Version 5.5.2-1.1: command added

auth multi-vlan-session

Overview Use this command to enable packet forwarding on multiple VLANs for an authenticated supplicant attached to a trunked (tagged VLAN) port.

By default, AlliedWare Plus only allows packet forwarding on the VLAN that a device was authenticated on. This command enables packet forwarding to the attached device on any VLAN configured on the switchport. After the device authenticates it will have access to all VLANs configured on the switchport.

Use the **no** variant of this command to disable packet forwarding on multiple VLANs for an authenticated supplicant.

Syntax `auth multi-vlan-session`
`no auth multi-vlan-session`

Default By default, **multi-vlan-session** is disabled.

Mode Interface Configuration for a static channel, a dynamic (LACP) channel group, or a switch port; or Authentication Profile mode.

Example To allow a client attached to port1.0.2 to access all VLANs configured on the AlliedWare Plus device, use the commands:

```
awplus# configure terminal
awplus(config)# interface port1.0.2
awplus(config-if)# switchport mode trunk
awplus(config-if)# switchport trunk allowed vlan all
awplus(config-if)# auth host-mode multi-supplicant
awplus(config-if)# auth multi-vlan-session
```

To disable **multi-vlan-session** on interface port1.0.2, use the commands:

```
awplus# configure terminal
awplus(config)# interface port1.0.2
awplus(config-if)# no auth multi-vlan-session
```

Related commands

- [auth-mac enable](#)
- [auth-web enable](#)
- [dot1x port-control](#)
- [show auth interface](#)
- [show dot1x interface](#)

Command changes Version 5.4.8-1.1: command added
Version 5.4.9-2.1: command added to AR2050V, AR3050S, and AR4050S

auth priority

Overview Use this command to enable authentication priority on an interface. This sets the tri-authentication order of priority for MAC, 802.1X, and web-based authentication. If tri-authentication is not configured on the interface then this command has no effect.

You specify the authentication methods in order of priority. The first method in the list has the highest priority, the second method has the second highest priority, and the third method has the lowest priority. Any methods not specified will have the lowest priority.

Use the **no** variant of this command to disable authentication priority.

Syntax `auth priority {[auth-mac] [dot1x] [auth-web]}`
`no auth priority`

Parameter	Description
auth-mac	Set MAC authentication priority.
dot1x	Set 802.1X authentication priority.
auth-web	Set web-based authentication priority.

Default Authentication priority is not set.

Mode Interface Configuration for a static channel, a dynamic (LACP) channel group, or a switch port; or Authentication Profile mode.

Usage notes Before using this command you must correctly configure tri-authentication on the interface. Tri-authentication is when multiple authentication methods (MAC, 802.1X, and/or web-based) are configured on the same interface. With tri-authentication, a supplicant is authorized to use the network as soon as they are successfully authenticated by any of the configured authentication methods.

When authentication priority is not set, once a supplicant is authenticated any future attempts to authenticate are ignored. When, however, authentication priority is set, and a higher priority authentication attempt is made by the supplicant, a new authentication process starts. The supplicant will then be authorized, or unauthorized, based on the result of this new authentication attempt.

Example To configure 802.1X authentication to have a higher priority than MAC authentication on interface port1.0.2, use the commands:

```
awplus# configure terminal
awplus(config)# interface port1.0.2
awplus(config-if)# switchport mode access
awplus(config-if)# auth-mac enable
awplus(config-if)# dot1x port-control auto
awplus(config-if)# auth priority dot1x auth-mac
```

To disable authentication priority on interface port1.0.2, use the commands:

```
awplus# configure terminal
awplus(config)# interface port1.0.2
awplus(config-if)# no auth priority
```

To configure 802.1X authentication to have a higher priority than MAC authentication on authentication profile 'student', use the commands:

```
awplus# configure terminal
awplus(config)# auth profile student
awplus(config-if)# switchport mode access
awplus(config-if)# auth-mac enable
awplus(config-if)# dot1x port-control auto
awplus(config-if)# auth priority dot1x auth-mac
```

Related commands

- [auth profile \(interface\)](#)
- [auth-mac enable](#)
- [auth-web enable](#)
- [dot1x port-control](#)

Command changes Version 5.5.0-2.1: command added

auth profile (global)

Overview Use this command to enter port authentication profile mode and configure a port authentication profile.

If the specified profile does not exist a new authentication profile is created with the name provided.

Use the **no** variant of this command to delete the specified port authentication profile.

Syntax `auth profile <profile-name>`
`no auth profile <profile-name>`

Parameter	Description
<code><profile-name></code>	Name of the profile to create or configure.

Default No port authentication profiles are created by default.

Mode Global Configuration

Usage A port authentication profile is a configuration object that aggregates multiple port authentication commands. These profiles are attached or detached from an interface using the [auth profile \(interface\)](#) command.

Example To create a new authentication profile 'student', use the following commands:

```
awplus# configure terminal
awplus(config)# auth profile student
awplus(config-auth-profile)#
```

To delete an authentication profile 'student', use the following commands:

```
awplus# configure terminal
awplus(config)# no auth profile student
```

Related commands [auth profile \(interface\)](#)
[description \(auth-profile\)](#)

auth profile (interface)

Overview Use this command to attach a port authentication profile to the current interface. Use the **no** variant of this command to detach a port authentication profile from the current interface.

Syntax `auth profile <profile-name>`
`no auth profile <profile-name>`

Parameter	Description
<code><profile-name></code>	The name of the profile to attach to the current interface.

Default No profile is attached by default.

Mode `auth-web`: Interface Configuration for an Eth interface, or Authentication Profile mode.
`auth-mac`: Interface Configuration for a static channel, a dynamic (LACP) channel group, or a switch port; or Authentication Profile mode.
`dot1x`: Interface Configuration for a switch port; or Authentication Profile mode.

Usage This command attaches an authentication profile, that was created using the [auth profile \(global\)](#) command, to an Eth port, a static channel, a dynamic (LACP) channel group, or a switch port.

You can only attach one profile to an interface at a time. Use the **no** variant of the command to detach a profile before attempting to attach another one.

Example To attach the authentication profile 'student' to eth1, use the following commands:

```
awplus# configure terminal
awplus(config)# interface eth1
awplus(config-if)# auth profile student
```

To detach the authentication profile 'student' from eth1, use the following commands:

```
awplus# configure terminal
awplus(config)# interface eth1
awplus(config-if)# no auth profile student
```

Related commands [auth profile \(global\)](#)

auth reauthentication

Overview Use this command to enable reauthentication on the interface specified in the Interface mode.

Use the **no** variant of this command to disable reauthentication on the interface.

Syntax `auth reauthentication`
`no auth reauthentication`

Default Reauthentication of port authentication is disabled by default.

Mode `auth-web`: Interface Configuration for an Eth interface, or Authentication Profile mode.
`auth-mac`: Interface Configuration for a static channel, a dynamic (LACP) channel group, or a switch port; or Authentication Profile mode.
`dot1x`: Interface Configuration for a switch port; or Authentication Profile mode.

Examples To enable reauthentication on interface eth1, use the following commands:

```
awplus# configure terminal
awplus(config)# interface eth1
awplus(config-if)# auth reauthentication
```

To disable reauthentication on interface eth1, use the following commands:

```
awplus# configure terminal
awplus(config)# interface eth1
awplus(config-if)# no auth reauthentication
```

To enable reauthentication on authentication profile 'student', use the commands:

```
awplus# configure terminal
awplus(config)# auth profile student
awplus(config-auth-profile)# auth reauthentication
```

Related commands [auth profile \(global\)](#)
[show dot1x](#)
[show dot1x interface](#)
[show running-config](#)

auth roaming disconnected

Overview This command allows a supplicant to move to another authenticating interface without reauthentication, even if the link is down for the interface that the supplicant is currently connected to.

You must enter the [auth roaming enable](#) command on both interfaces before using this command.

The **no** variant of this command disables roaming authentication on interfaces that are link-down, and forces a supplicant to be reauthenticated when moving between interfaces.

See the [AAA and Port Authentication Feature Overview and Configuration Guide](#) for further information about this feature.

Syntax `auth roaming disconnected`
`no auth roaming disconnected`

Default By default, the authentication status for a roaming supplicant is deleted when an interface goes down, so supplicants must reauthenticate.

Mode Interface Configuration for a static channel, a dynamic (LACP) channel group, or a switch port; or Authentication Profile mode.

Usage notes Note that 802.1X port authentication, MAC-authentication, or Web-authentication must be configured before using this feature. The port that the supplicant is moving to must have the same authentication configuration as the port the supplicant is moving from.

Examples To allow supplicants to move from port1.0.2 without reauthentication even when the link is down, when using 802.1X authentication, use the commands:

```
awplus# configure terminal
awplus(config)# interface port1.0.2
awplus(config-if)# dot1x port-control auto
awplus(config-if)# auth roaming enable
awplus(config-if)# auth roaming disconnected
```

To require supplicants to reauthenticate when moving from port1.0.2 if the link is down, when using 802.1X authentication, use the commands:

```
awplus# configure terminal
awplus(config)# interface port1.0.2
awplus(config-if)# no auth roaming disconnected
```

To allow supplicants using authentication profile 'student' to move between ports without reauthentication even when the link is down, use the commands:

```
awplus# configure terminal
awplus(config)# auth profile student
awplus(config-auth-profile)# auth roaming disconnected
```

To require supplicants using authentication profile 'student' to reauthenticate when moving between ports if the link is down, use the commands:

```
awplus# configure terminal
awplus(config)# auth profile student
awplus(config-auth-profile)# no auth roaming disconnected
```

**Related
commands**

- auth profile (global)
- auth-mac enable
- auth roaming enable
- auth-web enable
- dot1x port-control
- show auth interface
- show dot1x interface
- show running-config

auth roaming enable

Overview Use this command to allow a supplicant to move to another authenticating interface without reauthentication, providing the link is up for the interface that the supplicant is currently connected to.

The **no** variant of this command disables roaming authentication on an interface, and forces a supplicant to be reauthenticated when moving between interfaces.

See the [AAA and Port Authentication Feature Overview and Configuration Guide](#) for further information about this feature.

Syntax `auth roaming enable`
`no auth roaming enable`

Default Roaming authentication is disabled by default.

Mode Interface Configuration for a static channel, a dynamic (LACP) channel group, or a switch port; or Authentication Profile mode.

Usage notes Note that 802.1X port authentication or MAC authentication must be configured before using this feature. The port that the supplicant is moving to must have the same authentication configuration as the port the supplicant is moving from.

This command only enables roaming authentication for links that are up. If you want roaming authentication on links that are down, you must also use the command [auth roaming disconnected](#).

Examples To enable roaming authentication for port1.0.4, when using auth-mac authentication, use the commands:

```
awplus# configure terminal
awplus(config)# interface port1.0.4
awplus(config-if)# auth-mac enable
awplus(config-if)# auth roaming enable
```

To disable roaming authentication for port1.0.4, use the commands:

```
awplus# configure terminal
awplus(config)# interface port1.0.4
awplus(config-if)# no auth roaming enable
```

To enable roaming authentication for authentication profile 'student', use the commands:

```
awplus# configure terminal
awplus(config)# auth profile student
awplus(config-auth-profile)# auth roaming enable
```

Related commands

- auth profile (global)
- auth-mac enable
- auth roaming disconnected
- auth-web enable
- dot1x port-control
- show auth interface
- show dot1x interface
- show running-config

auth supplicant-ip

Overview Use this command to add a supplicant (client device) IP address on a given interface and provides parameters for its configuration.

Use the **no** variant of this command to delete the supplicant IP address and reset other parameters to their default values. The IP address can be determined before authentication for auth-web clients only.

Syntax `auth supplicant-ip <ip-addr> [max-reauth-req <1-10>]
[port-control {auto|force-authorized|force-unauthorized|
skip-second-auth}] [quiet-period <1-65535>] [reauth-period
<1-4294967295>] [supp-timeout <1-65535>] [server-timeout
<1-65535>] [reauthentication]

no auth supplicant-ip <ip-addr> [reauthentication]`

Parameter	Description
<ip-addr>	IP address of the supplicant entry in A.B.C.D/P format.
max-reauth-req	The number of reauthentication attempts before becoming unauthorized.
<1-10>	Count of reauthentication attempts (default 2).
port-control	Port control commands.
auto	A port control parameter that allows port clients to negotiate authentication.
force-authorized	A port control parameter that forces the port state to authorized.
force-unauthorized	A port control parameter that forces the port state to unauthorized.
skip-second-auth	Skip the second authentication.
quiet-period	Quiet period during which the port remains in the HELD state (default 60 seconds).
<1-65535>	Seconds for quiet period.
reauth-period	Seconds between reauthorization attempts (default 3600 seconds).
<1-4294967295>	Seconds for reauthorization attempts (reauth-period).
supp-timeout	Supplicant response timeout.
<1-65535>	Seconds for supplicant response timeout (default 30 seconds).
server-timeout	The period, in seconds, before the authentication server response times out.

Parameter	Description
<1-65535>	The server-timeout period, in seconds, default 3600 seconds.
reauthentication	Enable reauthentication on a port.

Default No supplicant IP address for port authentication exists by default until first created with the **auth supplicant-ip** command. The defaults for parameters applied are as shown in the table above.

Mode
 auth-web: Interface Configuration for an Eth interface, or Authentication Profile mode.
 auth-mac: Interface Configuration for a static channel, a dynamic (LACP) channel group, or a switch port; or Authentication Profile mode.
 dot1x: Interface Configuration for a switch port; or Authentication Profile mode.

Examples To add the supplicant IP address 192.168.10.0/24 to force authorized port control for interface eth1, use the commands:

```
awplus# configure terminal
awplus(config)# interface eth1
awplus(config-if)# auth supplicant-ip 192.168.10.0/24
port-control force-authorized
```

To delete the supplicant IP address 192.168.10.0/24 for interface eth1, use the commands:

```
awplus# configure terminal
awplus(config)# interface eth1
awplus(config-if)# no auth supplicant-ip 192.168.10.0/24
```

To disable reauthentication for the supplicant(s) IP address 192.168.10.0/24 for interface eth1, use the commands:

```
awplus# configure terminal
awplus(config)# interface eth1
awplus(config-if)# no auth supplicant-ip 192.168.10.0/24
reauthentication
```

To add the supplicant IP address 192.168.10.0/24 to force authorized port control for auth profile 'student', use the commands:

```
awplus# configure terminal
awplus(config)# auth profile student
awplus(config-auth-profile)# auth supplicant-ip
192.168.10.0/24 port-control force-authorized
```

Related commands

- [show auth](#)
- [show dot1x](#)
- [show dot1x interface](#)
- [show running-config](#)

auth supplicant-mac

Overview This command adds a supplicant (client device) MAC address or MAC mask on a given interface with the parameters as specified in the table below.

Use the **no** variant of this command to delete the supplicant MAC address and reset other parameters to their default values.

Syntax

```
auth supplicant-mac <mac-addr> [mask <mac-addr-mask>]
[max-reauth-req <1-10>] [port-control {auto|force-authorized|
force-unauthorized|skip-second-auth}] [quiet-period <1-65535>]
[reauth-period <1-4294967295>] [supp-timeout <1-65535>]
[server-timeout <1-65535>] [reauthentication]

no auth supplicant-mac <mac-addr> [reauthentication]
```

Parameter	Description
<mac-addr>	MAC (hardware) address of the supplicant entry in HHHH.HHHH.HHHH MAC address hexadecimal format.
mask	A mask applied to MAC addresses in order to select only those addresses containing a specific string.
<mac-addr-mask>	The mask comprises a string of three (period separated) bytes, where each byte comprises four hexadecimal characters that will generally be either 1 or 0. When the mask is applied to a specific MAC address, a match is only required for characters that correspond to a 1 in the mask. Characters that correspond to a 0 in the mask are effectively ignored. In the examples section below, the mask ffff.ff00.0000 is applied for the MAC address 0000.5E00.0000. The applied mask will then match only those MAC addresses that begin with 0000.5E (in this case the OUI component). The remaining portion of the addresses (in this case the NIC component) will be ignored.
port-control	Port control commands.
auto	Allow port client to negotiate authentication.
force-authorized	Force port state to authorized.
force-unauthorized	Force port state to unauthorized.
skip-second-auth	Skip the second authentication.
quiet-period	Quiet period in the HELD state (default 60 seconds).
<1-65535>	Seconds for quiet period.
reauth-period	Seconds between reauthorization attempts (default 3600 seconds).
<1-4294967295>	Seconds for reauthorization attempts (reauth-period).
supp-timeout	Supplicant response timeout (default 30 seconds).

Parameter	Description
<1-65535>	Seconds for supplicant response timeout.
server-timeout	Authentication server response timeout (default 30 seconds).
<1-65535>	Seconds for authentication server response timeout.
reauthentication	Enable reauthentication on a port.
max-reauth-req	No of reauthentication attempts before becoming unauthorized (default 2).
<1-10>	Count of reauthentication attempts.

Default No supplicant MAC address for port authentication exists by default until first created with the **auth supplicant-mac** command. The defaults for parameters are shown in the table above.

Mode auth-web: Interface Configuration for an Eth interface, or Authentication Profile mode.
auth-mac: Interface Configuration for a static channel, a dynamic (LACP) channel group, or a switch port; or Authentication Profile mode.
dot1x: Interface Configuration for a switch port; or Authentication Profile mode.

Examples To add the supplicant MAC address 0000.5E00.5343 to force authorized port control for interface port1.0.2, use the commands:

```
awplus# configure terminal
awplus(config)# interface port1.0.2
awplus(config-if)# auth supplicant-mac 0000.5E00.5343
port-control force-authorized
```

To apply the mask ffff.ff00.0000 in order to add any supplicant MAC addresses whose MAC address begins with 0000.5E, and then to force authorized port control for interface port1.0.2, use the commands:

```
awplus# configure terminal
awplus(config)# interface port1.0.2
awplus(config-if)# auth supplicant-mac 0000.5E00.0000 mask
ffff.ff00.0000 port-control force-authorized
```

To delete the supplicant MAC address 0000.5E00.5343 for interface port1.0.2, use the commands:

```
awplus# configure terminal
awplus(config)# interface port1.0.2
awplus(config-if)# no auth supplicant-mac 0000.5E00.5343
```

To disable reauthentication for the supplicant MAC address 0000.5E00.5343 for interface port1.0.2, use the commands:

```
awplus# configure terminal
awplus(config)# interface eth1
awplus(config-if)# no auth supplicant-mac 0000.5E00.5343
reauthentication
```

To add the supplicant MAC address 0000.5E00.5343 to force authorized port control for authentication profile 'student', use the commands:

```
awplus# configure terminal
awplus(config)# auth profile student
awplus(config-auth-profile)# auth supplicant-mac
0000.5E00.5343 port-control force-authorized
```

To delete the supplicant MAC address 0000.5E00.5343 for authentication profile 'student', use the commands:

```
awplus# configure terminal
awplus(config)# auth profile student
awplus(config-auth-profile)# no auth supplicant-mac
0000.5E00.5343
```

**Related
commands**

[show auth](#)
[show dot1x](#)
[show dot1x interface](#)
[show running-config](#)

auth timeout connect-timeout

Overview Use this command to set the connect-timeout period for the interface.
Use the **no** variant of this command to reset the connect-timeout period to the default.

Syntax `auth timeout connect-timeout <1-65535>`
`no auth timeout connect-timeout`

Parameter	Description
<1-65535>	Specifies the connect-timeout period (in seconds).

Default The connect-timeout default is 30 seconds.

Mode `auth-web`: Interface Configuration for an Eth interface, or Authentication Profile mode.
`auth-mac`: Interface Configuration for a static channel, a dynamic (LACP) channel group, or a switch port; or Authentication Profile mode.
`dot1x`: Interface Configuration for a switch port; or Authentication Profile mode.

Usage notes This command is used for MAC and web authentication. If the connect-timeout has lapsed and the supplicant has the state **connecting**, then the supplicant is deleted. When `auth-web-server session-keep` or `auth two-step enable` is enabled, we recommend you configure a longer connect-timeout period.

Examples To set the connect-timeout period to 3600 seconds for interface eth1, use the following commands:

```
awplus# configure terminal
awplus(config)# interface eth1
awplus(config-if)# auth timeout connect-timeout 3600
```

To reset the connect-timeout period to the default (30 seconds) for interface eth1, use the following commands:

```
awplus# configure terminal
awplus(config)# interface eth1
awplus(config-if)# no auth timeout connect-timeout
```

To set the connect-timeout period to 3600 seconds for authentication profile 'student', use the commands:

```
awplus# configure terminal
awplus(config)# auth profile student
awplus(config-auth-profile)# auth timeout connect-timeout 3600
```

Related commands [auth profile \(global\)](#)

`show dot1x`

`show dot1x interface`

auth timeout quiet-period

Overview Use this command to set a time period for which another authentication request is not accepted on a given interface, after an authentication request has failed.

Use the **no** variant of this command to reset the quiet period to the default.

Syntax `auth timeout quiet-period <1-65535>`
`no auth timeout quiet-period`

Parameter	Description
<1-65535>	Specifies the quiet period (in seconds).

Default The quiet period for port authentication is 60 seconds.

Mode `auth-web`: Interface Configuration for an Eth interface, or Authentication Profile mode.
`auth-mac`: Interface Configuration for a static channel, a dynamic (LACP) channel group, or a switch port; or Authentication Profile mode.
`dot1x`: Interface Configuration for a switch port; or Authentication Profile mode.

Examples To set the quiet period to 10 seconds for interface eth1, use the commands:

```
awplus# configure terminal
awplus(config)# interface eth1
awplus(config-if)# auth timeout quiet-period 10
```

To reset the quiet period to the default (60 seconds) for interface eth1, use the commands:

```
awplus# configure terminal
awplus(config)# interface eth1
awplus(config-if)# no auth timeout quiet-period
```

To set the quiet period to 10 seconds for authentication profile 'student', use the commands:

```
awplus# configure terminal
awplus(config)# auth profile student
awplus(config-auth-profile)# auth timeout quiet-period 10
```

Related commands [auth profile \(global\)](#)

auth timeout reauth-period

Overview Use this command to set the timer for reauthentication on a given interface. The re-authentication for the supplicant (client device) is executed at this timeout. The timeout is only applied if the **auth reauthentication** command is applied.

Use the **no** variant of this command to reset the **reauth-period** parameter to the default (3600 seconds).

Syntax `auth timeout reauth-period <1-4294967295>`
`no auth timeout reauth-period`

Parameter	Description
<1-4294967295>	The reauthentication timeout period (in seconds).

Default The default reauthentication period for port authentication is 3600 seconds, when reauthentication is enabled on the port.

Mode `auth-web`: Interface Configuration for an Eth interface, or Authentication Profile mode.
`auth-mac`: Interface Configuration for a static channel, a dynamic (LACP) channel group, or a switch port; or Authentication Profile mode.
`dot1x`: Interface Configuration for a switch port; or Authentication Profile mode.

Examples To set the reauthentication period to 1 day for interface eth1, use the following commands:

```
awplus# configure terminal
awplus(config)# interface eth1
awplus(config-if)# auth timeout reauth-period 86400
```

To reset the reauthentication period to the default (3600 seconds) for interface eth1, use the following commands:

```
awplus# configure terminal
awplus(config)# interface eth1
awplus(config-if)# no auth timeout reauth-period
```

To set the reauthentication period to 1 day for authentication profile 'student', use the commands:

```
awplus# configure terminal
awplus(config)# auth profile student
awplus(config-auth-profile)# auth timeout reauth-period 86400
```

To reset the reauthentication period to the default (3600 seconds) for authentication profile 'student', use the commands:

```
awplus# configure terminal
awplus(config)# auth profile student
awplus(config-auth-profile)# no auth timeout reauth-period
```

**Related
commands**

[auth profile \(global\)](#)
[auth reauthentication](#)
[show dot1x](#)
[show dot1x interface](#)
[show running-config](#)

auth timeout server-timeout

Overview Use this command to set the timeout for the waiting response from the RADIUS server on a given interface.

Use the **no** variant of this command to reset the server-timeout to the default (30 seconds).

Syntax `auth timeout server-timeout <1-65535>`
`no auth timeout server-timeout`

Parameter	Description
<1-65535>	Server timeout period (in seconds).

Default The server timeout for port authentication is 30 seconds.

Mode `auth-web`: Interface Configuration for an Eth interface, or Authentication Profile mode.
`auth-mac`: Interface Configuration for a static channel, a dynamic (LACP) channel group, or a switch port; or Authentication Profile mode.
`dot1x`: Interface Configuration for a switch port; or Authentication Profile mode.

Examples To set the server timeout to 120 seconds for interface `eth1`, use the following commands:

```
awplus# configure terminal
awplus(config)# interface eth1
awplus(config-if)# auth timeout server-timeout 120
```

To set the server timeout to the default (30 seconds) for interface `eth1`, use the following commands:

```
awplus# configure terminal
awplus(config)# interface eth1
awplus(config-if)# no auth timeout server-timeout
```

To set the server timeout to 120 seconds for authentication profile 'student', use the commands:

```
awplus# configure terminal
awplus(config)# auth profile student
awplus(config-auth-profile)# auth timeout server-timeout 120
```

To set the server timeout to the default (30 seconds) for authentication profile 'student', use the commands:

```
awplus# configure terminal
awplus(config)# auth profile student
awplus(config-auth-profile)# no auth timeout server-timeout
```

**Related
commands** auth profile (global)
 show dot1x
 show dot1x interface
 show running-config

auth timeout supp-timeout

Overview This command sets the timeout of the waiting response from the supplicant (client device) on a given interface.

The **no** variant of this command resets the supplicant timeout to the default (30 seconds).

Syntax `auth timeout supp-timeout <1-65535>`
`no auth timeout supp-timeout`

Parameter	Description
<1-65535>	The supplicant timeout period (in seconds).

Default The supplicant timeout for port authentication is 30 seconds.

Mode `auth-web`: Interface Configuration for an Eth interface, or Authentication Profile mode.
`auth-mac`: Interface Configuration for a static channel, a dynamic (LACP) channel group, or a switch port; or Authentication Profile mode.
`dot1x`: Interface Configuration for a switch port; or Authentication Profile mode.

Examples To set the supplicant timeout to 2 seconds for interface port1.0.2, use the following commands:

```
awplus# configure terminal
awplus(config)# interface port1.0.2
awplus(config-if)# auth timeout supp-timeout 2
```

To reset the supplicant timeout to the default (30 seconds) for interface port1.0.2, use the following commands:

```
awplus# configure terminal
awplus(config)# interface port1.0.2
awplus(config-if)# no auth timeout supp-timeout
```

To set the supplicant timeout to 2 seconds for authentication profile 'student', use the commands:

```
awplus# configure terminal
awplus(config)# auth profile student
awplus(config-auth-profile)# auth timeout supp-timeout 2
```

Related commands [auth profile \(global\)](#)
[show dot1x](#)
[show dot1x interface](#)
[show running-config](#)

auth vlan-restriction

Overview Use this command to restrict port authenticated supplicants on an interface to one per VLAN. This is useful, for example, if you have configured multiple supplicants on an interface but you want to restrict network access to a single IP phone and a single authorized workstation.

Use the **no** variant of this command to remove the single supplicant per VLAN restriction.

Syntax `auth vlan-restriction`
`no auth vlan-restriction`

Default Not configured

Mode Interface Configuration for a static channel, a dynamic (LACP) channel group, or a switch port; or Authentication Profile mode.

Usage notes This is a port authentication command, so you should first configure 802.1X, MAC, or web authentication. In addition, configure multi-supplicants on the interface using the **auth host-mode multi-supplicant** command.

This command works with both dynamic VLANs and static voice VLAN configurations.

Examples To restrict supplicants to a one per VLAN on interface port1.0.2, use the following commands:

```
awplus# configure terminal
awplus(config)# interface port1.0.2
awplus(config-if)# auth vlan-restriction
```

To remove the one per VLAN supplicant restriction on interface port1.0.2, use the following commands:

```
awplus# configure terminal
awplus(config)# interface port1.0.2
awplus(config-if)# no auth vlan-restriction
```

Related commands

- [auth dynamic-vlan-creation](#)
- [auth host-mode](#)
- [auth-mac enable](#)
- [auth-web enable](#)
- [dot1x port-control](#)
- [show auth interface](#)
- [show dot1x interface](#)
- [switchport voice vlan](#)

Command changes Version 5.5.1-2.1: command added

auth two-step enable

Overview Use this command to enable a two-step authentication feature on an interface. When this feature is enabled, the supplicant is authorized in a two-step process. If authentication succeeds, the supplicant becomes authenticated.

Use this command to apply the two-step authentication method based on 802.1X or MAC authentication.

Use the **no** variant of this command to disable the two-step authentication feature.

Syntax `auth two-step enable`
`no auth two-step enable`

Default Two step authentication is disabled by default.

Mode Interface Configuration for a switch port; or Authentication Profile mode.

Usage The single step authentication methods (either user or device authentication) have a potential security risk:

- an unauthorized user can access the network with an authorized device, or
- an authorized user can access the network with an unauthorized device.

Two-step authentication solves this problem by authenticating both the user and the device. The supplicant will only become authenticated if both these steps are successful. If the first authentication step fails, then the second step is not started.

Examples To enable the two step authentication feature, use the following commands:

```
awplus# configure terminal
awplus(config)# interface port1.0.2
awplus(config-if)# auth two-step enable
```

To disable the two step authentication feature, use the following commands:

```
awplus# configure terminal
awplus(config)# interface port1.0.2
awplus(config-if)# no auth two-step enable
```

To enable MAC authentication followed by 802.1X authentication, use the following commands:

```
awplus# configure terminal
awplus(config)# interface port1.0.2
awplus(config-if)# switchport mode access
awplus(config-if)# auth-mac enable
awplus(config-if)# dot1x port-control auto
awplus(config-if)# auth dynamic-vlan-creation
awplus(config-if)# auth two-step enable
```

To enable the two step authentication feature for authentication profile 'student', use the commands:

```
awplus# configure terminal
awplus(config)# auth profile student
awplus(config-auth-profile)# auth two-step enable
```

**Related
Commands**

[auth profile \(global\)](#)
[auth two-step order](#)
[show auth two-step supplicant brief](#)
[show auth](#)
[show auth interface](#)
[show auth supplicant](#)
[show dot1x](#)
[show dot1x interface](#)
[show dot1x supplicant](#)

**Command
changes**

Version 5.4.9-2.1: command added to AR2050V, AR3050S, and AR4050S

auth two-step order

Overview Use this command to configure the order for two-step authentication. Two-step authentication and the relevant authentication methods must be enabled on the interface.

Use the **no** variant of this command to reset the authentication order to the default.

Syntax

```
auth two-step order auth-mac dot1x
auth two-step order dot1x auth-mac
no auth two-step order
```

Parameter	Description
auth-mac	MAC authentication
dot1x	802.1X authentication

Default Order is determined by the authentication methods configured on the interface (see **Usage notes**).

Mode Interface Configuration for a switch port; or Authentication Profile mode.

Usage notes The default authentication order depends on the combination of the authentication methods configured on the interface:

- If auth-mac is configured then auth-mac will be the first method.
- If auth-mac is **not** configured then dot1x will become the first method.

Examples To set the two-step authentication order on port1.0.1 for 802.1X authentication and then MAC authentication, use the commands:

```
awplus# configure terminal
awplus(config)# interface port1.0.1
awplus(config-if)# switchport mode access
awplus(config-if)# auth-mac enable
awplus(config-if)# dot1x port-control auto
awplus(config-if)# auth two-step enable
awplus(config-if)# auth two-step order dot1x auth-mac
```

To reset the two-step authentication order back to the default, which would be MAC authentication then 802.1X authentication if configured as above, use the commands:

```
awplus# configure terminal
awplus(config)# interface port1.0.1
awplus(config-if)# no auth two-step order
```

Related commands auth two-step enable
auth-mac enable
dot1x port-control
show auth interface
show auth supplicant

Command changes Version 5.5.0-0.3: command added

auth-mac accounting

Overview Use this command to override the **default** RADIUS accounting method for MAC-based authentication on an interface by allowing you to apply a user-defined named list.

Use the **no** variant of this command to remove the named list from the interface and apply the **default** method.

Syntax `auth-mac accounting {default|<list-name>}`
`no auth-mac accounting`

Parameter	Description
default	Apply the default accounting method list
<list-name>	Apply the user-defined named list

Default The **default** method list is applied to an interface by default.

Mode Interface Configuration for a static channel, a dynamic (LACP) channel group, or a switch port; or Authentication Profile mode.

Example To apply the named list 'vlan10_acct' on the vlan10 interface, use the commands:

```
awplus# configure terminal
awplus(config)# interface vlan10
awplus(config-if)# auth-mac accounting vlan10_acct
```

To remove the named list from the vlan10 interface and set the accounting method back to **default**, use the commands:

```
awplus# configure terminal
awplus(config)# interface vlan10
awplus(config-if)# no auth-mac accounting
```

Related commands [aaa accounting auth-mac](#)

Command changes Version 5.4.8-2.1: Command added to AR2050V, AR3050S, AR4050S

auth-mac authentication

Overview This command overrides the **default** MAC authentication method on an interface by allowing you to apply a user-defined named list.

Use the **no** variant of this command to remove the named list from the interface and apply the **default** method.

Syntax `auth-mac authentication {default|<list-name>}`
`no auth-mac authentication`

Parameter	Description
default	Apply the default authentication method list
<list-name>	Apply a user-defined named list

Default The **default** method list is applied to an interface by default.

Mode Interface Configuration for a static channel, a dynamic (LACP) channel group, or a switch port; or Authentication Profile mode.

Example To apply the named list 'vlan10_auth' on the vlan10 interface, use the commands:

```
awplus# configure terminal
awplus(config)# interface vlan10
awplus(config-if)# auth-mac authentication vlan10_auth
```

To remove the named list from the vlan10 interface and set the authentication method back to **default**, use the commands:

```
awplus# configure terminal
awplus(config)# interface vlan10
awplus(config-if)# no auth-mac authentication
```

Related commands [aaa authentication auth-mac](#)

Command changes Version 5.4.8-2.1: Command added to AR2050V, AR3050S, AR4050S

auth-mac enable

Overview This command enables MAC authentication on the interface specified in the Interface command mode.

Use the **no** variant of this command to disable MAC authentication on an interface.

Syntax `auth-mac enable`
`no auth-mac enable`

Default MAC-Authentication is disabled by default.

Mode Interface Configuration for a static channel, a dynamic (LACP) channel group, or a switch port; or Authentication Profile mode.

Usage notes Enabling **spanning-tree edgeport** on ports after enabling MAC authentication avoids unnecessary re-authentication when the port state changes, which does not happen when spanning tree edgeport is enabled. Note that re-authentication is correct behavior without **spanning-tree edgeport** enabled.

Applying **switchport mode access** on ports is also good practice to set the ports to access mode with ingress filtering turned on, whenever ports for MAC authentication are in a VLAN.

If you attempt to change the authentication configuration on an interface that has threat protection quarantine configured, you will see the following error message:

```
% portx.x.x: Application Proxy quarantine configuration must be removed before port authentication is changed
```

Before changing the interface's authentication configuration you must either:

- remove the interface's threat protection configuration, or
- shut down the interface.

Examples To enable MAC authentication on interface port1.0.2 and enable spanning tree edgeport to avoid unnecessary re-authentication, use the following commands:

```
awplus# configure terminal
awplus(config)# interface port1.0.2
awplus(config-if)# auth-mac enable
awplus(config-if)# spanning-tree edgeport
awplus(config-if)# switchport mode access
```

To disable MAC authentication on interface port1.0.2, use the following commands:

```
awplus# configure terminal
awplus(config)# interface port1.0.2
awplus(config-if)# no auth-mac enable
```

To enable MAC authentication on authentication profile 'student', use the commands:

```
awplus# configure terminal
awplus(config)# auth profile student
awplus(config-auth-profile)# auth-mac enable
```

Related commands

- [auth profile \(global\)](#)
- [show auth](#)
- [show auth interface](#)
- [show running-config](#)

Command changes Version 5.4.8-2.1: Command added to AR2050V, AR3050S, AR4050S

auth-mac method

Overview This command sets the type of authentication method for MAC authentication that is used with RADIUS on the interface specified in the interface command mode.

The **no** variant of this command resets the authentication method used to the default method (PAP) as the RADIUS authentication method used by the MAC authentication.

Syntax `auth-mac method [eap-md5|pap]`
`no auth-mac method`

Parameter	Description
eap-md5	Enable EAP-MD5 as the authentication method.
pap	Enable PAP as the authentication method.

Default The MAC authentication method is PAP.

Mode Interface Configuration for a static channel, a dynamic (LACP) channel group, or a switch port; or Authentication Profile mode.

Examples To set the MAC authentication method to PAP on interface port1.0.2, use the following commands:

```
awplus# configure terminal
awplus(config)# interface port1.0.2
awplus(config-if)# auth-mac method pap
```

To set the MAC authentication method to the default on interface port1.0.2, use the following commands:

```
awplus# configure terminal
awplus(config)# interface port1.0.2
awplus(config-if)# no auth-mac method
```

To set the MAC authentication method to EAP-MD5 on authentication profile 'student', use the commands:

```
awplus# configure terminal
awplus(config)# auth profile student
awplus(config-auth-profile)# auth-mac method eap-md5
```

Related commands [auth profile \(global\)](#)
[show auth](#)

`show auth interface`

`show running-config`

**Command
changes**

Version 5.4.8-2.1: Command added to AR2050V, AR3050S, AR4050S

auth-mac password

Overview This command changes the password for MAC-based authentication. Use the **no** variant of this command to return the password to its default.

Syntax `auth-mac [encrypted] password <password>`
`no auth-mac password`

Parameter	Description
<code>auth-mac</code>	MAC-based authentication
<code>encrypted</code>	Specify an encrypted password
<code>password</code>	Configure the password
<code><password></code>	The new password. Passwords can be up to 64 characters in length and can contain any printable characters except: <ul style="list-style-type: none">• ?• " (double quotes)• space

Default By default, the password is the MAC address of the supplicant.

Mode Global Configuration

Usage notes Changing the password increases the security of MAC-based authentication, because the default password is easy for an attacker to discover. This is particularly important if:

- some MAC-based supplicants on the network are intelligent devices, such as computers.

Examples To change the password to `verySecurePassword`, use the commands:

```
awplus# configure terminal
awplus(config)# auth-mac password verySecurePassword
```

Related commands [show auth](#)

Command changes Version 5.4.8-2.1: Command added to AR2050V, AR3050S, AR4050S

auth-mac reauth-relearning

Overview This command sets the MAC address learning of the supplicant (client device) to re-learning for re-authentication on the interface specified in the interface command mode.

Use the **no** variant of this command to disable the auth-mac re-learning option.

Syntax `auth-mac reauth-relearning`
`no auth-mac reauth-relearning`

Default Re-learning for port authentication is disabled by default.

Mode Interface Configuration for a static channel, a dynamic (LACP) channel group, or a switch port; or Authentication Profile mode.

Examples To enable the re-authentication re-learning feature on interface port1.0.2, use the following commands:

```
awplus# configure terminal
awplus(config)# interface port1.0.2
awplus(config-if)# auth-mac reauth-relearning
```

To disable the re-authentication re-learning feature on interface port1.0.2, use the following commands:

```
awplus# configure terminal
awplus(config)# interface port1.0.2
awplus(config-if)# no auth-mac reauth-relearning
```

To enable the re-authentication re-learning feature on authentication profile 'student', use the commands:

```
awplus# configure terminal
awplus(config)# auth profile student
awplus(config-auth-profile)# auth-mac reauth-relearning
```

Related commands [auth profile \(global\)](#)
[show auth](#)
[show auth interface](#)
[show running-config](#)

Command changes Version 5.4.8-2.1: Command added to AR2050V, AR3050S, AR4050S

auth-mac static

Overview This command configures MAC authentication to use static entries in the FDB. Static entries persist in the FDB, even if there is no traffic flow from the supplicant.

When static FDB entries are configured, the [auth roaming disconnected](#) command is supported for MAC authentication. This command allows a supplicant to move to another authenticating interface without re-authentication.

Use the **no** variant of this command to revert to dynamic FDB entries.

Syntax `auth-mac static`
`no auth-mac static`

Default By default MAC authentication supplicants are added to the FDB dynamically.

Mode Global Configuration

Example To configure MAC authentication to use static FDB entries, use the following commands:

```
awplus# configure terminal
awplus(config)# auth-mac static
```

To configure MAC authentication to use dynamic FDB entries, use the following commands:

```
awplus# configure terminal
awplus(config)# no auth-mac static
```

Related commands [auth roaming disconnected](#)
[show auth](#)

Command changes Version 5.4.7-2.4: Command added
Version 5.4.8-2.1: Command added to AR2050V, AR3050S, AR4050S

auth-mac username

Overview Use this command to specify the format of the MAC address in the username and password field when a request for MAC-based authorization is sent to a RADIUS server.

Syntax `auth-mac username {ietf|unformatted} {lower-case|upper-case}`

Parameter	Description
<code>ietf</code>	The MAC address includes a hyphen between each 2 bytes. (Example: xx-xx-xx-xx-xx-xx)
<code>unformatted</code>	The MAC address does not include hyphens. (Example: xxxxxxxxxxxx)
<code>lower-case</code>	The MAC address uses lower-case characters (a-f)
<code>upper-case</code>	The MAC address uses upper-case characters (A-F)

Default `auth-mac username ietf lower-case`

Mode Global Configuration

Usage This command is provided to allow other vendors', AlliedWare, and AlliedWare Plus switches to share the same format on the RADIUS server.

Example To configure the format of the MAC address in the username and password field to be changed to IETF and upper-case, use the following commands:

```
awplus# configure terminal
awplus(config)# auth-mac username ietf upper-case
```

Related commands [auth-mac username](#)
[show running-config](#)

Command changes Version 5.4.8-2.1: Command added to AR2050V, AR3050S, AR4050S

auth-web accounting

Overview This command overrides the default RADIUS accounting method for web-based authentication on an interface by allowing you to apply a user-defined named list.

Use the **no** variant of this command to remove the named list from the interface and apply the default method.

Syntax `auth-web accounting {default|<list-name>}`
`no auth-web accounting`

Parameter	Description
default	Apply the default accounting method list
<list-name>	Apply a named accounting method list

Default The **default** method list is applied to an interface by default.

Mode Interface Configuration for an Eth interface, or Authentication Profile mode.

Example To apply the named list 'example_acct' on the eth1 interface, use the commands:

```
awplus# configure terminal
awplus(config)# interface eth1
awplus(config-if)# auth-web accounting example_acct
```

To remove the named list from the eth1 interface and set the accounting method back to default, use the commands:

```
awplus# configure terminal
awplus(config)# interface eth1
awplus(config-if)# no auth-web accounting
```

Related commands [aaa accounting auth-web](#)

auth-web authentication

Overview Use this command to override the default web-based authentication method on an interface by allowing you to apply a user-defined named list.

Use the **no** variant of this command to remove the named list from the interface and apply the default method.

Syntax `auth-web authentication {default|<list-name>}`
`no auth-web authentication`

Parameter	Description
default	Apply the default authentication method list
<list-name>	Apply the user-defined named list

Default The **default** method list is applied to an interface by default.

Mode Interface Configuration for an Eth interface, or Authentication Profile mode.

Example To apply the named list 'example_auth' on the eth1 interface, use the commands:

```
awplus# configure terminal
awplus(config)# interface eth1
awplus(config-if)# auth-web authentication example_auth
```

To remove the named list from the eth1 interface and set the authentication method back to default, use the commands:

```
awplus# configure terminal
awplus(config)# interface eth1
awplus(config-if)# no auth-web authentication
```

Related commands [aaa authentication auth-web](#)

auth-web enable

Overview Use this command to enable web-based authentication in Interface mode on the interface specified.

Use the **no** variant of this command to apply its default.

Syntax auth-web enable
no auth-web enable

Default Web authentication is disabled by default.

Mode Interface Configuration for an Eth interface, or Authentication Profile mode.

Usage notes You need to configure an IPv4 address for the Ethernet interface on which Web Authentication is running.

When the **protect (firewall)** command and the **web-auth enable** command are both configured, you need to configure a firewall rule to allow Auth-web traffic to pass through the firewall. Web-auth uses TCP ports 8081, 8082, 8083 and 8084. You can create a firewall rule like the following example:

```
!
application auth-apl
protocol tcp
dport 8081 to 8084
!
!
firewall
    rule 65 permit auth-apl from private.supPLICANT to
private.supPLICANT.router
!
```

If you attempt to change the authentication configuration on an interface that has threat protection quarantine configured, you will see the following error message:

```
% portx.x.x: Application Proxy quarantine configuration must be
removed before port authentication is changed
```

Before changing the interface's authentication configuration you must either:

- remove the interface's threat protection configuration, or
- shut down the interface.

Examples To enable web authentication on eth1, use the following commands:

```
awplus# configure terminal
awplus(config)# interface eth1
awplus(config-if)# auth-web enable
```

To disable web authentication on eth1, use the following commands:

```
awplus# configure terminal
awplus(config)# interface eth1
awplus(config-if)# no auth-web enable
```

To enable web authentication on authentication profile 'student', use the commands:

```
awplus# configure terminal
awplus(config)# auth profile student
awplus(config-auth-profile)# auth-web enable
```

To disable web authentication on authentication profile 'student', use the commands:

```
awplus# configure terminal
awplus(config)# auth profile student
awplus(config-auth-profile)# no auth-web enable
```

**Related
commands**

[auth profile \(global\)](#)

[show auth](#)

[show auth interface](#)

[show running-config](#)

auth-web forward

Overview Use this command to enable the web authentication packet forwarding feature on the interface specified. This command also enables ARP forwarding, and adds forwarded packets to the **tcp** or **udp** port number specified.

Use the **no** variant of this command to disable the specified packet forwarding feature on the interface.

Syntax `auth-web forward [<ip-address>|<ip-address/prefix-length>]
{dns|tcp <1-65535>|udp <1-65535>}`

or

`auth-web forward {arp|dhcp|dns|tcp <1-65535>|udp <1-65535>}`

The **no** variants of this command are:

`no auth-web forward [<ip-address>|<ip-address/prefix-length>]
{dns|tcp <1-65535>|udp <1-65535>}`

or

`no auth-web forward {arp|dhcp|dns|tcp <1-65535>|udp <1-65535>}`

Parameter	Description
<code><ip-address></code> <code><ip-address/ prefix-length></code>	The IP address or subnet on which the web authentication is to be enabled.
<code>arp</code>	Enable forwarding of ARP.
<code>dhcp</code>	Enable forwarding of DHCP (67/udp).
<code>dns</code>	Enable forwarding of DNS (53/udp).
<code>tcp</code>	Enable forwarding of TCP specified port number.
<code><1-65535></code>	TCP Port number.
<code>udp</code>	Enable forwarding of UDP specified port number.
<code><1-65535></code>	UDP Port number.

Default Packet forwarding for port authentication is enabled by default for "arp", "dhcp" and "dns".

Mode Interface Configuration for an Eth interface, or Authentication Profile mode.

Usage notes For more information about the `<ip-address>` parameter, and an example, see the "auth-web forward" section in the [AlliedWare Plus Technical Tips and Tricks](#).

Examples To enable the ARP forwarding feature on interface eth1, use the following commands:

```
awplus# configure terminal
awplus(config)# interface eth1
awplus(config-if)# auth-web forward arp
```

To add TCP forwarding port 137 on interface eth1, use the following commands:

```
awplus# configure terminal
awplus(config)# interface eth1
awplus(config-if)# auth-web forward tcp 137
```

To disable the ARP forwarding feature on interface eth1, use the following commands:

```
awplus# configure terminal
awplus(config)# interface eth1
awplus(config-if)# no auth-web forward arp
```

To delete TCP forwarding port 137 on interface eth1, use the following commands:

```
awplus# configure terminal
awplus(config)# interface eth1
awplus(config-if)# no auth-web forward tcp 137
```

To delete all TCP forwarding on interface eth1, use the following commands:

```
awplus# configure terminal
awplus(config)# interface eth1
awplus(config-if)# no auth-web forward tcp
```

To enable the ARP forwarding feature on authentication profile 'student', use the commands:

```
awplus# configure terminal
awplus(config)# auth profile student
awplus(config-auth-profile)# auth-web forward arp
```

To add TCP forwarding port 137 on authentication profile 'student', use the commands:

```
awplus# configure terminal
awplus(config)# auth profile student
awplus(config-auth-profile)# auth-web forward tcp 137
```

To disable the ARP forwarding feature on authentication profile 'student', use the commands:

```
awplus# configure terminal
awplus(config)# auth profile student
awplus(config-auth-profile)# no auth-web forward arp
```

To delete TCP forwarding port 137 on authentication profile 'student', use the commands:

```
awplus# configure terminal
awplus(config)# auth profile student
awplus(config-auth-profile)# no auth-web forward tcp 137
```

To delete all TCP forwarding on authentication profile 'student', use the commands:

```
awplus# configure terminal
awplus(config)# auth profile student
awplus(config-auth-profile)# no auth-web forward tcp
```

Related commands

- [auth profile \(global\)](#)
- [show auth](#)
- [show auth interface](#)

auth-web idle-timeout enable

Overview Use this command to enable the idle-timeout for client of web authentication on the interface.

The **no** variant of this command to disable the idle-timeout for client of web authentication on the interface.

Syntax `auth-web idle-timeout enable`
`no auth-web idle-timeout enable`

Default The idle-timeout is disabled by default.

Mode Interface Configuration for an Eth interface, or Authentication Profile mode.

Example To enable the idle-timeout on an interface, use the following commands:

```
awplus# configure terminal
awplus(config)# interface eth1
awplus(config)# auth-web enable
awplus(config-if)# auth-web idle-timeout enable
```

To disable the idle-timeout on an interface, use the following commands:

```
awplus# configure terminal
awplus(config)# interface eth1
awplus(config-if)# no auth-web idle-timeout enable
```

Related commands [auth-web enable](#)
[auth-web idle-timeout timeout](#)

auth-web idle-timeout timeout

Overview Use this command to set the timeout value for web authentication client in seconds. The client will be unauthorized when it does not have any activity for a period that exceeds the timeout value.

The **no** variant of this command sets the timeout value to the default setting, 3600 seconds.

Syntax `auth-web idle-timeout timeout <420-86400>`
`no auth-web idle-timeout timeout`

Parameter	Description
<420-86400>	Time in seconds.

Default The timeout is 3600 seconds by default.

Mode Interface Configuration for an Eth interface, or Authentication Profile mode.

Example To set 30 minutes as the idle-timeout, use the following commands:

```
awplus# configure terminal
awplus(config)# interface eth1
awplus(config-if)# auth-web idle-timeout timeout 1800
```

To return the idle-timeout to the default, use the following commands:

```
awplus# configure terminal
awplus(config)# interface eth1
awplus(config-if)# no auth-web idle-timeout timeout
```

Related commands [auth-web enable](#)
[auth-web idle-timeout enable](#)

auth-web max-auth-fail

Overview Use this command to set the number of authentication failures allowed before rejecting further authentication requests. When the supplicant (client device) fails more than the specified number of times, then login requests are refused during the quiet period.

Use the **no** variant of this command to reset the maximum number of authentication failures to the default.

Syntax `auth-web max-auth-fail <0-10>`
`no auth-web max-auth-fail`

Parameter	Description
<0-10>	The maximum number of authentication failures allowed before login requests are refused.

Default The maximum number of authentication failures is set to 3.

Mode Interface Configuration for an Eth interface, or Authentication Profile mode.

Examples To set the lock count to 5 on interface eth1, use the following commands:

```
awplus# configure terminal
awplus(config)# interface eth1
awplus(config-if)# auth-web max-auth-fail 5
```

To set the lock count to the default on interface eth1, use the following commands:

```
awplus# configure terminal
awplus(config)# interface eth1
awplus(config-if)# no auth-web max-auth-fail
```

To set the lock count to 5 on authentication profile 'student', use the commands:

```
awplus# configure terminal
awplus(config)# auth profile student
awplus(config-auth-profile)# auth-web max-auth-fail 5
```

To set the lock count to the default on authentication profile 'student', use the commands:

```
awplus# configure terminal
awplus(config)# auth profile student
awplus(config-auth-profile)# no auth-web max-auth-fail
```

Related commands

- auth profile (global)
- auth timeout quiet-period
- show auth
- show auth interface
- show running-config

auth-web method

Overview Use this command to set the web authentication access method that is used with RADIUS on the interface specified.

Use the **no** variant of this command to set the authentication method to PAP for the interface specified when web authentication is also used with the RADIUS authentication method.

Syntax `auth-web method {eap-md5|pap}`
`no auth-web method`

Parameter	Description
eap-md5	Enable EAP-MD5 as the authentication method.
pap	Enable PAP as the authentication method.

Default The web authentication method is set to PAP by default.

Mode Interface Configuration for an Eth interface, or Authentication Profile mode.

Example To set the web authentication method to EAP-MD5 on interface eth1, use the following commands:

```
awplus# configure terminal
awplus(config)# interface eth1
awplus(config-if)# auth-web method eap-md5
```

To set the web authentication method to EAP-MD5 for authentication profile 'student', use the commands:

```
awplus# configure terminal
awplus(config)# auth profile student
awplus(config-auth-profile)# auth-web method eap-md5
```

Related commands

- [auth profile \(global\)](#)
- [show auth](#)
- [show auth interface](#)
- [show running-config](#)

auth-web-server dhcp ipaddress

Overview Use this command to assign an IP address and enable the DHCP service on the Web-Authentication server for supplicants (client devices).

Use the **no** variant of this command to remove an IP address and disable the DHCP service on the Web-Authentication server for supplicants.

Syntax `auth-web-server dhcp ipaddress <ip-address/prefix-length>`
`no auth-web-server dhcp ipaddress`

Parameter	Description
<code><ip-address/prefix-length></code>	The IPv4 address and prefix length assigned for the DHCP service on the Web-Authentication server for supplicants.

Default No IP address for the Web-Authentication server is set by default.

Mode Global Configuration

Usage notes See the [AAA and Port Authentication Feature Overview and Configuration Guide](#) for information about:

- using DHCP with web authentication, and
- restrictions regarding combinations of authentication enhancements working together

You cannot use the IPv4 address assigned to the device's interface as the Web-Authentication server address.

Note that this Web Authentication virtual DHCP server is a limited implementation of the DHCP protocol. Separation of IP addresses depends on allocating addresses incrementally and a short lease time. In a situation where a supplicant remains permanently connected but does not authenticate, there is a risk of re-allocation of the same IP address once the server has rolled through the entire address range.

Examples To assign the IP address 10.0.0.1 to the Web-Authentication server, use the following commands:

```
awplus# configure terminal
awplus(config)# auth-web-server dhcp ipaddress 10.0.0.1/8
```

To remove an IP address on the Web-Authentication server, use the following commands:

```
awplus# configure terminal
awplus(config)# no auth-web-server dhcp ipaddress
```

Related commands `auth-web-server dhcp lease`
`show auth-web-server`
`show running-config`

auth-web-server dhcp lease

Overview Use this command to set the DHCP lease time for supplicants (client devices) using the DHCP service on the Web-Authentication server.

Use the **no** variant of this command to reset to the default DHCP lease time for supplicants using the DHCP service on the Web-Authentication server.

Syntax `auth-web-server dhcp lease <20-60>`
`no auth-web-server dhcp lease`

Parameter	Description
<20-60>	DHCP lease time for supplicants using the DHCP service on the Web-Authentication server in seconds.

Default The default DHCP lease time for supplicants using the DHCP service on the Web-Authentication server is set to 30 seconds.

Mode Global Configuration

Usage notes See the [AAA and Port Authentication Feature Overview and Configuration Guide](#) for information about:

- using DHCP with web authentication, and
- restrictions regarding combinations of authentication enhancements working together

Examples To set the DHCP lease time to 1 minute for supplicants using the DHCP service on the Web-Authentication server, use the following commands:

```
awplus# configure terminal
awplus(config)# auth-web-server dhcp lease 60
```

To reset the DHCP lease time to the default setting (30 seconds) for supplicants using the DHCP service on the Web-Authentication server, use the following commands:

```
awplus# configure terminal
awplus(config)# no auth-web-server dhcp lease
```

Validation Commands `show running-config`

Related commands `show auth-web-server`
`auth-web-server dhcp ipaddress`

auth-web-server dhcp-wpad-option

Overview This command sets the DHCP WPAD (Web Proxy Auto-Discovery) option for the Web-Authentication temporary DHCP service.

For more information and examples, see the “Web Auth Proxy” section in the [AlliedWare Plus Technical Tips and Tricks](#).

Use the **no** variant of this command to disable the DHCP WPAD function.

Syntax `auth-web-server dhcp wpad-option <url>`
`no auth-web-server dhcp wpad-option`

Parameter	Description
<code><url></code>	URL to the server which gets a .pac file.

Default The Web-Authentication server DHCP WPAD option is not set.

Mode Global Configuration

Usage notes If the supplicant is configured to use WPAD, the supplicant’s web browser will use TCP port 80 as usual. Therefore, the packet can be intercepted by Web-Authentication as normal, and the Web-Authentication Login page can be sent. However, after authentication, the browser does not know where to get the WPAD file and so cannot access external web pages. The WPAD file is usually named proxy.pac file and tells the browser what web proxy to use.

Use this command to tell the supplicant where it can get this file from. The switch itself can be specified as the source for this file, and it can deliver it to the supplicant on request.

Example To specify that the proxy.pac file is found on the server at 192.168.1.100, use the following commands:

```
awplus# configure terminal
awplus(config)# auth-web-server dhcp wpad-option
http://192.168.1.100/proxy/proxy.pac
```

Related commands [show auth-web-server](#)

auth-web-server host-name

Overview This command assigns a hostname to the web authentication server.
Use the **no** variant of this command to remove the hostname from the web authentication server.

Syntax `auth-web-server host-name <hostname>`
`no auth-web-server host-name`

Parameter	Description
<code><hostname></code>	URL string of the hostname

Default The web authentication server has no hostname.

Mode Global Configuration

Usage notes When the web authentication server uses HTTPS protocol, the web browser will validate the certificate. If the certificate is invalid, the web page gives a warning message before displaying server content. However, the web page will not give warning message if the server has a hostname same as the one stored in the installed certificate.

Examples To set the `auth.example.com` as the hostname of the web authentication server, use the commands:

```
awplus# configure terminal  
awplus(config)# auth-web-server host-name auth.example.com
```

To remove hostname `auth.example.com` from the web authentication server, use the commands:

```
awplus# configure terminal  
awplus(config)# no auth-web-server host-name
```

Related commands [aaa authentication auth-web](#)
[auth-web enable](#)

auth-web-server intercept-port

Overview This command specifies any additional TCP port numbers that the Web-Authentication server is to intercept.

Use the **no** variant of this command to stop intercepting the TCP port numbers.

Syntax `auth-web-server intercept-port {<1-65535>|any}`
`no auth-web-server intercept-port {<1-65535>|any}`

Parameter	Description
<1-65535>	TCP port number.
any	Intercept all TCP packets

Default No additional TCP port numbers are intercepted by default.

Mode Global Configuration

Usage notes If this command is not specified, AlliedWare Plus Web-Authentication intercepts the supplicant's initial TCP port 80 connection to a web page and sends it the Web-Authentication Login page. However, if the supplicant is configured to use a web proxy, then it will usually be using TCP port 8080 (or another user configured port number). In this case Web-Authentication cannot intercept the connection.

To overcome this limitation you can use this command to tell the switch which additional port it should intercept, and then send the Web-Authentication Login page to the supplicant.

When the web authentication switch is in a guest network, the switch does not know the proxy server's port number in the supplicant's proxy setting. To overcome this limitation, you can use the **any** option in this command to intercept all TCP packets.

When you use this command in conjunction with a proxy server configured in the web browser, you must add the proxy server's network as a 'No Proxy' network. You can specify 'No Proxy' networks in the proxy settings in your web browser. For more information, see the "Web Auth Proxy" section in the [Alliedware Plus Technical Tips and Tricks](#).

Example To additionally intercept port number 3128, use the following commands:

```
awplus# configure terminal
awplus(config)# auth-web-server intercept-port 3128
```

Related commands [show auth-web-server](#)

auth-web-server ip-conflict-prefer-newer-supPLICANT

Overview Use this command to alter the behavior of a Network Access Server (NAS) when it detects a supplicant with a duplicate IP address.

The default behavior is for the NAS to not authorize the newer supplicant. This command allows it to authorize the newer supplicant and unauthorize the original supplicant.

This command applies to Web-based authentication supplicants only.

Use the **no** variant of this command to set the behavior back to default.

Syntax `auth-web-server ip-conflict-prefer-newer-supPLICANT`
`no auth-web-server ip-conflict-prefer-newer-supPLICANT`

Default The default behavior is to not authorize the newer supplicant if the NAS detects a duplicate IP address.

Mode Global Configuration

Usage notes Allied Telesis recommends you investigate and resolve the root cause of the conflicting IP addresses.

Example To configure a NAS to authorize the newer supplicant, use the commands:

```
awplus# configure terminal
awplus(config)# auth-web-server
ip-conflict-prefer-newer-supPLICANT
```

Related commands [auth-web enable](#)
[show auth](#)

Command changes Version 5.5.2-0.1: command added

auth-web-server ipaddress

Overview This command sets the IP address for the Web-Authentication server.

Use the **no** variant of this command to delete the IP address for the Web-Authentication server.

You cannot use the IPv4 address assigned to the device's interface as the Web-Authentication server address.

Syntax `auth-web-server ipaddress <ip-address>`
`no auth-web-server ipaddress`

Parameter	Description
<code><ip-address></code>	Web-Authentication server dotted decimal IP address in A.B.C.D format.

Default The Web-Authentication server address on the system is not set by default.

Mode Global Configuration

Examples To set the IP address 10.0.0.1 to the Web-Authentication server, use the following commands:

```
awplus# configure terminal
awplus(config)# auth-web-server ipaddress 10.0.0.1
```

To delete the IP address from the Web-Authentication server, use the following commands:

```
awplus# configure terminal
awplus(config)# no auth-web-server ipaddress
```

Validation Commands `show auth`
`show auth-web-server`
`show running-config`

auth-web-server page language

Overview Use this command to set the presentation language of Web authentication pages. Titles and subtitles of Web authentication pages will be set accordingly. Note that presently only English or Japanese are offered.

Use the **no** variant of this command to set the presentation language of Web authentication pages to its default (English).

Syntax `auth-web-server page language {english|japanese}`
`no auth-web-server page language`

Parameter	Description
english	Web authentication pages are presented in English.
japanese	Web authentication pages are presented in Japanese.

Default Web authentication pages are presented in English by default.

Mode Global Configuration

Examples To set Japanese as the presentation language of Web authentication pages, use the following commands:

```
awplus# configure terminal
awplus(config)# auth-web-server page language japanese
```

To set English as the presentation language of Web authentication pages, use the following commands:

```
awplus# configure terminal
awplus(config)# auth-web-server page language english
```

To unset the presentation language of Web authentication pages and use English as the default presentation language, use the following commands:

```
awplus# configure terminal
awplus(config)# no auth-web-server page language
```

Related commands [auth-web-server page title](#)
[auth-web-server page sub-title](#)
[show auth-web-server page](#)

auth-web-server login-url

Overview This command sets the web-authentication login page URL. This lets you replace the login page with your own page. See “Customising the Login Page” in the [AAA and Port Authentication Feature Overview and Configuration Guide](#) for details.

Use the **no** variant of this command to delete the URL.

Syntax `auth-web-server login-url <URL>`
`no auth-web-server login-url`

Parameter	Description
<URL>	Set login page URL

Default The built-in login page is set by default.

Mode Global Configuration

Examples To set `http://example.com/login.html` as the login page, use the commands:

```
awplus# configure terminal
awplus(config)# auth-web-server login-url
http://example.com/login.html
```

To unset the login page URL, use the commands:

```
awplus# configure terminal
awplus(config)# no auth-web-server login-url
```

Related commands [show running-config](#)

auth-web-server page logo

Overview This command sets the type of logo that will be displayed on the web authentication page.

Use the **no** variant of this command to set the logo type to **auto**.

Note that if you need to customize the login page extensively, you can instead replace it with your own page. See “Customising the Login Page” in the [AAA and Port Authentication Feature Overview and Configuration Guide](#).

Syntax `auth-web-server page logo {auto|default|hidden}`
`no auth-web-server page logo`

Parameter	Description
auto	Display the custom logo if installed; otherwise display the default logo
default	Display the default logo
hidden	Hide the logo

Default Logo type is **auto** by default.

Mode Global Configuration

Examples To display the default logo with ignoring installed custom logo, use the commands:

```
awplus# configure terminal
awplus(config)# auth-web-server page logo default
```

To set back to the default logo type **auto**, use the commands:

```
awplus# configure terminal
awplus(config)# no auth-web-server page logo
```

Validation Commands `show auth-web-server page`

auth-web-server page sub-title

Overview This command sets the custom sub-title on the web authentication page.

Use the **no** variant of this command to reset the sub-title to its default.

Note that if you need to customize the login page extensively, you can instead replace it with your own page. See “Customising the Login Page” in the [AAA and Port Authentication Feature Overview and Configuration Guide](#).

Syntax `auth-web-server page sub-title {hidden|text <sub-title>}`
`no auth-web-server page sub-title`

Parameter	Description
hidden	Hide the sub-title
<sub-title>	Text string of the sub-title

Default “Allied-Telesis” is displayed by default.

Mode Global Configuration

Examples To set the custom sub-title, use the commands:

```
awplus# configure terminal
awplus(config)# auth-web-server page sub-title text Web
Authentication
```

To hide the sub-title, use the commands:

```
awplus# configure terminal
awplus(config)# auth-web-server page sub-title hidden
```

To change back to the default title, use the commands:

```
awplus# configure terminal
awplus(config)# no auth-web-server page sub-title
```

Validation Commands `show auth-web-server page`

auth-web-server page success-message

Overview This command sets the success message on the web-authentication page.

Use the **no** variant of this command to remove the success message.

Note that if you need to customize the login page extensively, you can instead replace it with your own page. See “Customising the Login Page” in the [AAA and Port Authentication Feature Overview and Configuration Guide](#).

Syntax `auth-web-server page success-message text <success-message>`
`no auth-web-server page success-message`

Parameter	Description
<code><success-message></code>	Text string of the success message

Default No success message is set by default.

Mode Global Configuration

Examples To set the success message on the web-authentication page, use the commands:

```
awplus# configure terminal
awplus(config)# auth-web-server page success-message text Your
success message
```

To unset the success message on the web-authentication page, use the commands:

```
awplus# configure terminal
awplus(config)# no auth-web-server page success-message
```

Validation Commands `show auth-web-server page`

auth-web-server page title

Overview This command sets the custom title on the web authentication page.

Use the **no** variant of this command to remove the custom title.

Note that if you need to customize the login page extensively, you can instead replace it with your own page. See “Customising the Login Page” in the [AAA and Port Authentication Feature Overview and Configuration Guide](#).

Syntax `auth-web-server page title {hidden|text <title>}`
`no auth-web-server page title`

Parameter	Description
hidden	Hide the title
<title>	Text string of the title

Default “Web Access Authentication Gateway” is displayed by default.

Mode Global Configuration

Examples To set the custom title on the web authentication page, use the commands:

```
awplus# configure terminal
awplus(config)# auth-web-server page title text Login
```

To hide the title on the web authentication page, use the commands:

```
awplus# configure terminal
awplus(config)# auth-web-server page title hidden
```

To unset the custom title on the web authentication page, use the commands:

```
awplus# configure terminal
awplus(config)# no auth-web-server page title
```

Validation Commands `show auth-web-server page`

auth-web-server page welcome-message

Overview This command sets the welcome message on the web-authentication login page.

Use the **no** variant of this command to remove the welcome message.

Note that if you need to customize the login page extensively, you can instead replace it with your own page. See “Customising the Login Page” in the [AAA and Port Authentication Feature Overview and Configuration Guide](#).

Syntax `auth-web-server page welcome-message text <welcome-message>`
`no auth-web-server page welcome-message`

Parameter	Description
<code><welcome-message></code>	Text string of the welcome message

Default No welcome message is set by default.

Mode Global Configuration

Examples To set the welcome message on the web-authentication page, use the commands:

```
awplus# configure terminal
awplus(config)# auth-web-server page welcome-message text Your
welcome message
```

To remove the welcome message on the web-authentication page, use the commands:

```
awplus# configure terminal
awplus(config)# no auth-web-server page welcome-message
```

Validation Commands [show auth-web-server page](#)

auth-web-server ping-poll enable

Overview This command enables the ping polling to the supplicant (client device) that is authenticated by Web-Authentication.

The **no** variant of this command disables the ping polling to the supplicant that is authenticated by Web-Authentication.

Syntax `auth-web-server ping-poll enable`
`no auth-web-server ping-poll enable`

Default The ping polling feature for Web-Authentication is disabled by default.

Mode Global Configuration

Examples To enable the ping polling feature for Web-Authentication, use the following commands:

```
awplus# configure terminal
awplus(config)# auth-web-server ping-poll enable
```

To disable the ping polling feature for Web-Authentication, use the following commands:

```
awplus# configure terminal
awplus(config)# no auth-web-server ping-poll enable
```

Validation Commands `show auth`
`show auth-web-server`
`show running-config`

auth-web-server ping-poll failcount

Overview This command sets a fail count for the ping polling feature when used with Web-Authentication. The **failcount** parameter specifies the number of unanswered pings. A supplicant (client device) is logged off when the number of unanswered pings are greater than the failcount set with this command.

Use the **no** variant of this command to resets the fail count for the ping polling feature to the default (5 pings).

Syntax `auth-web-server ping-poll failcount <1-100>`
`no auth-web-server ping-poll failcount`

Parameter	Description
<1-100>	Count.

Default The default failcount for ping polling is 5 pings.

Mode Global Configuration

Examples To set the failcount of ping polling to 10 pings, use the following commands:

```
awplus# configure terminal  
awplus(config)# auth-web-server ping-poll failcount 10
```

To set the failcount of ping polling to default, use the following commands:

```
awplus# configure terminal  
awplus(config)# no auth-web-server ping-poll failcount
```

Validation Commands `show auth`
`show auth-web-server`
`show running-config`

auth-web-server ping-poll interval

Overview This command is used to change the ping poll interval. The interval specifies the time period between pings when the supplicant (client device) is reachable.

Use the **no** variant of this command to reset to the default period for ping polling (30 seconds).

Syntax `auth-web-server ping-poll interval <1-65535>`
`no auth-web-server ping-poll interval`

Parameter	Description
<1-65535>	Seconds.

Default The interval for ping polling is 30 seconds by default.

Mode Global Configuration

Examples To set the interval of ping polling to 60 seconds, use the following commands:

```
awplus# configure terminal
awplus(config)# auth-web-server ping-poll interval 60
```

To set the interval of ping polling to the default (30 seconds), use the following commands:

```
awplus# configure terminal
awplus(config)# no auth-web-server ping-poll interval
```

Validation Commands `show auth`
`show auth-web-server`
`show running-config`

auth-web-server ping-poll reauth-timer-refresh

Overview This command modifies the **reauth-timer-refresh** parameter for the Web-Authentication feature. The **reauth-timer-refresh** parameter specifies whether a re-authentication timer is reset and when the response from a supplicant (a client device) is received.

Use the **no** variant of this command to reset the **reauth-timer-refresh** parameter to the default setting (disabled).

Syntax `auth-web-server ping-poll reauth-timer-refresh`
`no auth-web-server ping-poll reauth-timer-refresh`

Default The `reauth-timer-refresh` parameter is disabled by default.

Mode Global Configuration

Examples To enable the `reauth-timer-refresh` timer, use the following commands:

```
awplus# configure terminal
awplus(config)# auth-web-server ping-poll reauth-timer-refresh
```

To disable the `reauth-timer-refresh` timer, use the following commands:

```
awplus# configure terminal
awplus(config)# no auth-web-server ping-poll
reauth-timer-refresh
```

**Validation
Commands** `show auth`
`show auth-web-server`
`show running-config`

auth-web-server ping-poll timeout

Overview This command modifies the ping poll **timeout** parameter for the Web-Authentication feature. The **timeout** parameter specifies the time in seconds to wait for a response to a ping packet.

Use the **no** variant of this command to reset the timeout of ping polling to the default (1 second).

Syntax `auth-web-server ping-poll timeout <1-30>`
`no auth-web-server ping-poll timeout`

Parameter	Description
<1-30>	Seconds.

Default The default timeout for ping polling is 1 second.

Mode Global Configuration

Examples To set the timeout of ping polling to 2 seconds, use the command:

```
awplus# configure terminal
awplus(config)# auth-web-server ping-poll timeout 2
```

To set the timeout of ping polling to the default (1 second), use the command:

```
awplus# configure terminal
awplus(config)# no auth-web-server ping-poll timeout
```

Validation Commands `show auth`
`show auth-web-server`
`show running-config`

auth-web-server ping-poll type

Overview Use this command to set the type of polling used to check that a web authenticated supplicant is still connected. The polling can be done using either ICMP (ping), or ARP messages.

If there is a firewall between an authenticating server and a supplicant, it may block ICMP traffic. If this occurs try changing to ARP polling.

Polling only starts when ping-polling is enabled and the supplicant has been authorized.

Use the **no** variant of this command to set the default polling type of ICMP (ping).

Syntax `auth-web-server ping-poll type {arp|ping}`
`no auth-web-server ping-poll type`

Parameter	Description
auth-web-server	Web authentication server configuration commands
arp	Enable polling via ARP
ping	Enable polling via ICMP (ping)

Default ICMP

Mode Global Configuration

Examples To set the polling type to ARP, use the commands:

```
awplus# configure terminal
awplus(config)# auth-web-server ping-poll enable
awplus(config)# auth-web-server ping-poll type arp
```

To set the polling type to ICMP, use the commands:

```
awplus# configure terminal
awplus(config)# auth-web-server ping-poll enable
awplus(config)# auth-web-server ping-poll type ping
```

To set the polling type to the default, use the commands:

```
awplus# configure terminal
awplus(config)# no auth-web-server ping-poll type
```

Related commands [auth-web-server ping-poll enable](#)
[auth-web-server ping-poll failcount](#)
[auth-web-server ping-poll interval](#)
[auth-web-server ping-poll reauth-timer-refresh](#)

auth-web-server ping-poll timeout
show auth-web-server

Command changes Version 5.5.1-1.1: command added

auth-web-server port

Overview This command sets the HTTP port number for the Web-Authentication server. Use the **no** variant of this command to reset the HTTP port number to the default (80).

Syntax `auth-web-server port <port-number>`
`no auth-web-server port`

Parameter	Description
<code><port-number></code>	Set the local Web-Authentication server port within the TCP port number range 1 to 65535.

Default The Web-Authentication server HTTP port number is set to 80 by default.

Mode Global Configuration

Examples To set the HTTP port number 8080 for the Web-Authentication server, use the following commands:

```
awplus# configure terminal
awplus(config)# auth-web-server port 8080
```

To reset to the default HTTP port number 80 for the Web-Authentication server, use the following commands:

```
awplus# configure terminal
awplus(config)# no auth-web-server port
```

Validation Commands `show auth`
`show auth-web-server`
`show running-config`

auth-web-server redirect-delay-time

Overview Use this command to set the delay time in seconds before redirecting the supplicant to a specified URL when the supplicant is authorized.

Use the variant **no** to reset the delay time set previously.

Syntax `auth-web-server redirect-delay-time <5-60>`
`no auth-web-server redirect-delay-time`

Parameter	Description
<code>redirect-delay-time</code>	Set the delay time before jumping to a specified URL after the supplicant is authorized.
<code><5-60></code>	The time in seconds.

Default The default redirect delay time is 5 seconds.

Mode Global Configuration

Examples To set the delay time to 60 seconds for the Web-Authentication server, use the following commands:

```
awplus# configure terminal
awplus(config)# auth-web-server redirect-delay-time 60
```

To reset the delay time, use the following commands:

```
awplus# configure terminal
awplus(config)# no auth-web-server redirect-delay-time
```

Related commands [auth-web-server redirect-url](#)
[show auth-web-server](#)
[show running-config](#)

auth-web-server redirect-url

Overview This command sets a URL for supplicant (client device) authentication. When a supplicant is authorized it will be automatically redirected to the specified URL. Note that if the http redirect feature is used then this command is ignored.

Use the **no** variant of this command to delete the URL string set previously.

Syntax `auth-web-server redirect-url <url>`
`no auth-web-server redirect-url`

Parameter	Description
<code><url></code>	URL (hostname or dotted IP notation).

Default The redirect URL for the Web-Authentication server feature is not set by default (null).

Mode Global Configuration

Examples To enable and set redirect a URL string `www.alliedtelesis.com` for the Web-Authentication server, use the following commands:

```
awplus# configure terminal
awplus(config)# auth-web-server redirect-url
http://www.alliedtelesis.com
```

To delete a redirect URL string, use the following commands:

```
awplus# configure terminal
awplus(config)# no auth-web-server redirect-url
```

Related commands [auth-web-server redirect-delay-time](#)
[show auth](#)
[show auth-web-server](#)
[show running-config](#)

auth-web-server session-keep

Overview This command enables the session-keep feature to jump to the original URL after being authorized by Web-Authentication.

Use the **no** variant of this command to disable the session keep feature.

Syntax `auth-web-server session-keep`
`no auth-web-server session-keep`

Default The session-keep feature is disabled by default.

Mode Global Configuration

Usage notes This function doesn't ensure to keep session information in all cases. Authenticated supplicant may be redirected to unexpected page when session-keep is enabled. This issue occurred by supplicant sending HTTP packets automatically after authentication page is displayed and the URL is written.

Examples To enable the session-keep feature, use the following commands:

```
awplus# configure terminal
awplus(config)# auth-web-server session-keep
```

To disable the session-keep feature, use the following commands:

```
awplus# configure terminal
awplus(config)# no auth-web-server session-keep
```

Validation Commands `show auth`
`show auth-web-server`
`show running-config`

auth-web-server ssl

Overview This command enables HTTPS functionality for the Web-Authentication server feature.

Use the **no** variant of this command to disable HTTPS functionality for the Web-Authentication server.

Syntax `auth-web-server ssl`
`no auth-web-server ssl`

Default HTTPS functionality for the Web-Authentication server feature is disabled by default.

Mode Global Configuration

Examples To enable HTTPS functionality for the Web-Authentication server feature, use the following commands:

```
awplus# configure terminal
awplus(config)# auth-web-server ssl
```

To disable HTTPS functionality for the Web-Authentication server feature, use the following commands:

```
awplus# configure terminal
awplus(config)# no auth-web-server ssl
```

Validation Commands `show auth`
`show auth-web-server`
`show running-config`

auth-web-server ssl intercept-port

Overview Use this command to register HTTPS intercept port numbers when the HTTPS server uses custom port number (not TCP port number 443).

Note that you need to use the **auth-web-server intercept-port** command to register HTTP intercept port numbers.

Use the **no** variant of this command to delete registered port number.

Syntax `auth-web-server ssl intercept-port <1-65535>`
`no auth-web-server ssl intercept-port <1-65535>`

Parameter	Description
<1-65535>	TCP port number in the range from 1 through 65535

Default 443/TCP is registered by default.

Mode Global Configuration

Examples To register HTTPS port number 3128, use the commands:

```
awplus# configure terminal
awplus(config)# auth-web-server ssl intercept-port 3128
```

To delete HTTPS port number 3128, use the commands:

```
awplus# configure terminal
awplus(config)# no auth-web-server ssl intercept-port 3128
```

Validation Commands `show auth-web-server`

Related commands `auth-web-server intercept-port`

auth-web-server trustpoint

Overview Use this command to set the PKI trustpoint to use for secure web authentication communication to an AlliedWare Plus device.

Use the **no** variant of this command to revert to using the default trustpoint 'default-selfsigned'.

Syntax `auth-web-server trustpoint <trustpoint-name>`
`no auth-web-server trustpoint`

Parameter	Description
<code><trustpoint-name></code>	Name of trustpoint

Default By default, web authentication uses the 'default-selfsigned' trustpoint.

Mode Global Configuration

Usage notes Before using the **auth-web-server trustpoint** command you will need to establish a trustpoint. For example, you can create a local self-signed trustpoint using the procedure outlined below.

Create a self-signed trustpoint called 'web-trust' with keypair 'web_key':

```
awplus# configure terminal
awplus(config)# crypto pki trustpoint web-trust
awplus(ca-trustpoint)# enrollment selfsigned
awplus(ca-trustpoint)# rsakeypair web_key
awplus(ca-trustpoint)# exit
awplus(config)# exit
```

Create the root and server certificates for this trustpoint:

```
awplus# crypto pki authenticate web-trust
awplus# crypto pki enroll web-trust
```

For more information about the AlliedWare Plus implementation of Public Key Infrastructure (PKI), see the [Public Key Infrastructure \(PKI\) Feature Overview and Configuration Guide](#)

Example To configure web authentication to use the trustpoint 'web-trust', use the commands:

```
awplus# configure terminal
awplus(config)# auth-web-server trustpoint web-trust
```

To configure web authentication to use the default trustpoint 'default-selfsigned', use the commands:

```
awplus# configure terminal  
awplus(config)# no auth-web-server trustpoint
```

**Related
commands**

[crypto pki trustpoint](#)
[show crypto pki certificates](#)
[show crypto pki trustpoint](#)

**Command
changes**

Version 5.5.1-2.1: command added

copy proxy-autoconfig-file

Overview Use this command to download the proxy auto configuration (PAC) file to your switch. The Web-Authentication supplicant can get the downloaded file from the system web server.

Syntax `copy <filename> proxy-autoconfig-file`

Parameter	Description
<code><filename></code>	The URL of the PAC file.

Mode Privileged Exec

Example To download the PAC file to this device, use the command:

```
awplus# copy tftp://server/proxy.pac proxy-autoconfig-file
```

Related commands [show proxy-autoconfig-file](#)
[erase proxy-autoconfig-file](#)

copy web-auth-https-file

Overview Use this command to download the SSL server certificate for web-based authentication. The file must be in PEM (Privacy Enhanced Mail) format, and contain the private key and the server certificate.

Syntax `copy <filename> web-auth-https-file`

Parameter	Description
<code><filename></code>	The URL of the server certificate file.

Mode Privileged Exec

Example To download the server certificate file `verisign_cert.pem` from the TFTP server directory `server`, use the command:

```
awplus# copy tftp://server/verisign_cert.pem  
web-auth-https-file
```

Related commands

- [auth-web-server ssl](#)
- [erase web-auth-https-file](#)
- [show auth-web-server](#)

description (auth-profile)

Overview Use this command to add a description to an authentication profile in Authentication Profile mode.

Use the **no** variant of this command to remove the current description.

Syntax `description <description>`

Parameter	Description
<code><description></code>	Text describing the selected authentication profile.

Default No description configured by default.

Mode Authentication Profile

Example To add a description to the authentication profile 'student', use the following commands:

```
awplus# configure terminal
awplus(config)# auth profile student
awplus(config-auth-profile)# description student room setting
```

To remove a description from the authentication profile 'student', use the following commands:

```
awplus# configure terminal
awplus(config)# auth profile student
awplus(config-auth-profile)# no description
```

Related commands [auth profile \(global\)](#)

erase proxy-autoconfig-file

Overview Use this command to remove the proxy auto configuration file.

Syntax `erase proxy-autoconfig-file`

Mode Privileged Exec

Example To remove the proxy auto configuration file, use the command:

```
awplus# erase proxy-autoconfig-file
```

Related commands [show proxy-autoconfig-file](#)
[copy proxy-autoconfig-file](#)

erase web-auth-https-file

Overview Use this command to remove the SSL server certificate for web-based authentication.

Syntax `erase web-auth-https-file`

Mode Privileged Exec

Example To remove the SSL server certificate file for web-based authentication use the command:

```
awplus# erase web-auth-https-file
```

Related commands

- [auth-web-server ssl](#)
- [copy web-auth-https-file](#)
- [show auth-web-server](#)

show auth

Overview This command shows the configuration state of authentication.

Syntax show auth [all]

Parameter	Description
all	Display all authentication information for each authenticated interface. This can be a static channel (or static aggregator), or a dynamic (or LACP) channel group, or a switch port.

Mode Privileged Exec

Example To display all authentication information, enter the command:

```
awplus# show auth all
```

Output Figure 41-1: Example output from the **show auth** command

```
awplus# show auth all
802.1X Port-Based Authentication Enabled
MAC-based Port Authentication Disabled
WEB-based Port Authentication Enabled
  RADIUS server address (auth): 150.87.17.192:1812
  Last radius message id: 4
Authentication Info for interface eth1
  portEnabled: true - portControl: Auto
  portStatus: Authorized
  reAuthenticate: disabled
  reAuthPeriod: 3600
  PAE: quietPeriod: 60 - maxReauthReq: 2 - txPeriod: 30
  BE: suppTimeout: 30 - serverTimeout: 30
  CD: adminControlledDirections: in
  KT: keyTxEnabled: false
  critical: disabled
  guestVlan: disabled
  authFailVlan: disabled
  dynamicVlanCreation: disabled
  multiVlanCreation: disabled
  hostMode: single-host
  dot1x: enabled
    protocolVersion: 1
  authMac: disabled
  authWeb: enabled
    method: PAP
    maxAuthFail: 3
  packetForwarding:
    10.0.0.1 80/tcp
  dns
  dhcp
```

show auth diagnostics

Overview This command shows authentication diagnostics, optionally for the specified interface, which may be an Ethernet port.

If no interface is specified then authentication diagnostics are shown for all interfaces.

Syntax `show auth diagnostics [interface <interface-list>]`

Parameter	Description
<code>interface</code>	Specify ports to show.
<code><interface-list></code>	The interfaces or ports to configure. An interface-list can be: <ul style="list-style-type: none">• an interface (e.g. eth1)• a continuous range of interfaces, e.g. eth1-2• a comma-separated list of the above; e.g. eth1, eth2. The specified interfaces must exist.

Mode Privileged Exec

Example To display authentication diagnostics for eth1, enter the command:

```
awplus# show auth diagnostics interface eth1
```

Output Figure 41-2: Example output from the **show auth diagnostics** command

```
Authentication Diagnostics for interface eth1
  Supplicant address: 00d0.59ab.7037
    authEnterConnecting: 2
    authEaplogoffWhileConnecting: 1
    authEnterAuthenticating: 2
    authSuccessWhileAuthenticating: 1
    authTimeoutWhileAuthenticating: 1
    authFailWhileAuthenticating: 0
    authEapstartWhileAuthenticating: 0
    authEaplogoggWhileAuthenticating: 0
    authReauthsWhileAuthenticated: 0
    authEapstartWhileAuthenticated: 0
    authEaplogoffWhileAuthenticated: 0
  BackendResponses: 2
  BackendAccessChallenges: 1
  BackendOtherrequestToSupplicant: 3
  BackendAuthSuccess: 1
```

show auth interface

Overview This command shows the status of port authentication on the specified interface.

Syntax `show auth interface <interface-list>`

Parameter	Description
<code><interface-list></code>	The interfaces to display information about. An interface-list can be: <ul style="list-style-type: none">• a VLAN (e.g. vlan2)• a switchport (e.g. port1.0.4)• a static channel group (e.g. sa2)• a dynamic (LACP) channel group (e.g. po2)• a continuous range of interfaces separated by a hyphen (e.g. port1.0.1-port1.0.3)• a comma-separated list (e.g. port1.0.1, port1.0.3-port1.0.4). Do not mix interface types in a list.

Mode Privileged Exec

Example To display the port-based authentication status for eth1, enter the command:

```
awplus# show auth interface eth1
```

If port-based authentication is not configured, the output will be:

```
% Port-Control not configured on eth1
```

To display the port-based authentication status for eth1, enter the command:

```
awplus# show auth interface eth1
```

```
awplus# show auth interface eth1
Authentication Info for interface eth1
portEnabled: true - portControl: Auto
portStatus: Authorized
reAuthenticate: disabled
reAuthPeriod: 3600
PAE: quietPeriod: 60 - maxReauthReq: 2 - txPeriod: 30
BE: suppTimeout: 30 - serverTimeout: 30
CD: adminControlledDirections: in
KT: keyTxEnabled: false
critical: disabled
guestVlan: disabled
authFailVlan: disabled
dynamicVlanCreation: disabled
hostMode: single-host
dot1x: enabled
    protocolVersion: 1
authMac: disabled
authWeb: enabled
    method: PAP
    maxAuthFail: 3
    packetForwarding:
        10.0.0.1 80/tcp
        dns
        dhcp
twoStepAuthentication:
    configured: enabled
    actual: enabled
    order: dot1x auth-web
supplicantMac: none
```

Related commands

- [show auth diagnostics](#)
- [show dot1x sessionstatistics](#)
- [show dot1x statistics interface](#)
- [show dot1x supplicant interface](#)

show auth sessionstatistics

Overview This command shows authentication session statistics for the specified interface.

Syntax `show auth sessionstatistics [interface <interface-list>]`

Parameter	Description
interface	Specify ports to show.
<interface-list>	The interfaces or ports to configure. An interface-list can be: <ul style="list-style-type: none">• an interface (e.g. eth1)• a continuous range of interfaces, e.g. eth1-2• a comma-separated list of the above; e.g. eth1, eth2 The specified interfaces must exist.

Mode Privileged Exec

Example To display authentication statistics for eth1, enter the command:

```
awplus# show auth sessionstatistics interface eth1
```

Output Figure 41-3: Example output from the **show auth sessionstatistics** command

```
Authentication session statistics for interface eth1      session
user name: manager
  session authentication method: Remote server
  session time: 19440 secs
  session terminat cause: Not terminated yet
```

show auth statistics interface

Overview Use this command to show the authentication statistics for the specified interface.

Syntax `show auth statistics interface <interface-list>`

Parameter	Description
<code><interface-list></code>	The interfaces to display information about. An interface-list can be: <ul style="list-style-type: none">• a VLAN (e.g. vlan2)• a switchport (e.g. port1.0.4)• a static channel group (e.g. sa2)• a dynamic (LACP) channel group (e.g. po2)• a continuous range of interfaces separated by a hyphen (e.g. port1.0.1-port1.0.3)• a comma-separated list (e.g. port1.0.1, port1.0.3-port1.0.4). Do not mix interface types in a list.

Mode Privileged Exec

Example To display authentication statistics for port1.0.2, enter the command:

```
awplus# show auth statistics interface port1.0.2
```

Output Figure 41-4: Example output from **show auth statistics interface** for a port

```
awplus# show auth statistics interface port1.0.2
802.1X statistics for interface port1.0.2
  EAPOL Frames Rx: 5 - EAPOL Frames Tx: 16
  EAPOL Start Frames Rx: 0 - EAPOL Logoff Frames Rx: 0
  EAP Rsp/Id Frames Rx: 3 - EAP Response Frames Rx: 2
  EAP Req/Id Frames Tx: 8 - EAP Request Frames Tx: 2
  Invalid EAPOL Frames Rx: 0 - EAP Length Error Frames Rx: 0
  EAPOL Last Frame Version Rx: 1 - EAPOL Last Frame
Src:00d0.59ab.7037
```

Related commands [show dot1x interface](#)

show auth supplicant

Overview Use this command to show the supplicant (client device) state when authentication is configured for the switch. Use the optional **brief** parameter to show a summary of the supplicant state.

Syntax show auth supplicant [*<macadd>*] [brief]

Parameter	Description
<i><macadd></i>	Mac (hardware) address of the supplicant. Entry format is HHHH.HHHH.HHHH (hexadecimal).
brief	Brief summary of the supplicant state.

Mode Privileged Exec

Examples To display a summary of authenticated supplicant information on the device, enter the command:

```
awplus# show auth supplicant brief
```

To display authenticated supplicant information on the device, enter the command:

```
awplus# show auth supplicant
```

To display authenticated supplicant information for the device with MAC address 0000.5E00.5301, enter the command:

```
awplus# show auth supplicant 0000.5E00.5301
```

Output Figure 41-5: Example output from **show auth supplicant brief**

```
awplus#show auth supplicant brief
Interface port1.0.3
  authenticationMethod: dot1x/mac/web
  Two-Step Authentication
    firstMethod: mac
    secondMethod: dot1x/web
  totalSupplicantNum: 1
  authorizedSupplicantNum: 1
    macBasedAuthenticationSupplicantNum: 0
    dot1xAuthenticationSupplicantNum: 0
    webBasedAuthenticationSupplicantNum: 1
    otherAuthenticationSupplicantNum: 0

Interface  VID  Mode  MAC Address      Status           IP Address      Username
=====  ==  ==  =====  =====  =====
port1.0.3  1    W    001c.233e.e15a  Authenticated   192.168.1.181  test
port1.0.3  1    D    0240.4040.4040  Authenticated   --             test
port1.0.3  1    Q    0230.3030.3030  Authenticated   192.168.1.181  test
```

Figure 41-6: Example output from **show auth supplicant**

```
awplus#show auth supplicant
Interface port1.0.3
  authenticationMethod: dot1x/mac/web
  Two-Step Authentication
    firstMethod: mac
    secondMethod: dot1x/web
  totalSupplicantNum: 1
  authorizedSupplicantNum: 1
    macBasedAuthenticationSupplicantNum: 0
    dot1xAuthenticationSupplicantNum: 0
    webBasedAuthenticationSupplicantNum: 1
    otherAuthenticationSupplicantNum: 0

  Supplicant name: test
  Supplicant address: 0000.5E00.5301
  authenticationMethod: WEB-based Authentication
  Two-Step Authentication:
    firstAuthentication: Pass - Method: mac
    secondAuthentication: Pass - Method: web
  portStatus: Authorized - currentId: 1
  abort:F fail:F start:F timeout:F success:T
  PAE: state: Authenticated - portMode: Auto
  PAE: reAuthCount: 0 - rxRespId: 0
  PAE: quietPeriod: 60 - maxReauthReq: 2
  BE: state: Idle - reqCount: 0 - idFromServer: 0
  CD: adminControlledDirections: in - operControlledDirections: in
  CD: bridgeDetected: false
  KR: rxKey: false
  KT: keyAvailable: false - keyTxEnabled: false
  dynamicVlanId: 999
  dynamicTaggedVlanId: 0
  RADIUS server group (auth): radius
  RADIUS server (auth): 192.168.1.40
  Session timeout enabled: No
  dynamicACL Rules:
    ip:deny ip 10.37.165.10/24 any
    ip:permit ip any any
    ipv6:deny ipv6 any any
  Quarantined: true
  Quarantine Vlan: 999
```

Figure 41-7: Example output from **show auth supplicant 0000.5E00.5301**

```
awplus#show auth supplicant 0000.5E00.5301
Interface port1.0.3
  Supplicant name: test
  Supplicant address: 0000.5E00.5301
  authenticationMethod: WEB-based Authentication
  Two-Step Authentication:
    firstAuthentication: Pass - Method: mac
    secondAuthentication: Pass - Method: web
  portStatus: Authorized - currentId: 1
  abort:F fail:F start:F timeout:F success:T
  PAE: state: Authenticated - portMode: Auto
  PAE: reAuthCount: 0 - rxRespId: 0
  PAE: quietPeriod: 60 - maxReauthReq: 2
  BE: state: Idle - reqCount: 0 - idFromServer: 0
  CD: adminControlledDirections: in - operControlledDirections: in
  CD: bridgeDetected: false
  Quarantined: true
  Quarantine Vlan: 999
  KR: rxKey: false
  KT: keyAvailable: false - keyTxEnabled: false
  RADIUS server group (auth): radius
  RADIUS server (auth): 192.168.1.40
  Session timeout enabled: No
  dynamicACL Rules:
    ip:deny ip 10.37.165.10/24 any
    ip:permit ip any any
    ipv6:deny ipv6 any any
```

Related commands

- [aaa accounting auth-mac](#)
- [aaa accounting auth-web](#)
- [aaa accounting dot1x](#)
- [aaa authentication auth-mac](#)
- [aaa authentication auth-web](#)
- [aaa authentication dot1x](#)

show auth supplicant interface

Overview This command shows the supplicant (client device) state for the authentication mode set for the interface. Use the optional **brief** parameter to show a summary of the supplicant state.

Syntax `show auth-web supplicant interface <interface-list> [brief]`

Parameter	Description
<code><interface-list></code>	The interfaces or ports to configure. An interface-list can be: <ul style="list-style-type: none">• an interface (e.g. eth1)• a continuous range of interfaces, e.g. eth1-2• a comma-separated list of the above; e.g. eth1, eth2 The specified interfaces must exist.
<code>brief</code>	Brief summary of the supplicant state.

Mode Privileged Exec

Examples To display the authenticated supplicant on the interface eth1, enter the command:

```
awplus# show auth supplicant interface eth1
```

To display brief summary output for the authenticated supplicant on the interface eth1, enter the command:

```
awplus# show auth supplicant interface eth1 brief
```

show auth two-step supplicant brief

Overview This command displays the supplicant state of the two-step authentication feature on the interface.

Syntax `show auth two-step supplicant [interface <interface-list>] brief`

Parameter	Description
interface	The interface selected for display.
<interface-list>	The interfaces to display information about. An interface-list can be: <ul style="list-style-type: none">• a VLAN (e.g. vlan2)• a switchport (e.g. port1.0.4)• a static channel group (e.g. sa2)• a dynamic (LACP) channel group (e.g. po2)• a continuous range of interfaces separated by a hyphen (e.g. port1.0.1-port1.0.3)• a comma-separated list (e.g. port1.0.1, port1.0.3-port1.0.4). Do not mix interface types in a list.

Mode Privileged Exec

Usage notes Do not mix interface types in a list. The specified interfaces must exist.

Example To display the supplicant state of the two-step authentication feature, enter the command:

```
awplus# show two-step supplicant interface port1.0.2 brief
```

Output Figure 41-8: Example output from **show auth two-step supplicant brief**

```
interface port1.0.2

authenticationMethod: dot1x/mac

Two-Step Authentication:
  firstMethod:mac
  secondMethod:dot1x
totalSupplicantNum: 1
authorizedSupplicantNum: 1
  macBasedAuthenticationSupplicantNum: 0
  dot1xAuthenticationSupplicantNum: 1
  webBasedAuthenticationSupplicantNum: 0
  otherAuthenticationSupplicantNum: 0

Interface  VID Mode  MAC Address      Status           FirstStep        SecondStep
=====  ===  =====  =====
port1.0.8  1    D        000b..db67.00f7  Authenticated   Pass             Pass
```

Related commands [auth two-step enable](#)

Command changes Version 5.4.9-2.1: command added to AR2050V, AR3050S, and AR4050S

show auth-web-server

Overview This command shows the Web-Authentication server configuration and status on the switch.

Syntax `show auth-web-server`

Mode Privileged Exec

Example To display Web-Authentication server configuration and status, enter the command:

```
awplus# show auth-web-server
```

Output Figure 41-9: Example output from the **show auth-web-server** command

```
Web authentication server
  Server status: enabled
  Server mode: none
  Server address: 192...
    DHCP server enabled
    DHCP lease time: 20
    DHCP WPAD Option URL: http://...
  HTTP Port No: 80
  Security: disabled
  Certification: default
  SSL Port No: 443
  Redirect URL: --
  Redirect Delay Time: 5
  HTTP Redirect: enabled
  Session keep: disabled
  PingPolling: disabled
  PingPollingType: Ping
  PingInterval: 30
  Timeout: 1
  FailCount: 5
  ReauthTimerReFresh: disabled
```

- Related commands**
- [auth-web-server ipaddress](#)
 - [auth-web-server port](#)
 - [auth-web-server redirect-delay-time](#)
 - [auth-web-server redirect-url](#)
 - [auth-web-server session-keep](#)
 - [auth-web-server ssl](#)

show auth-web-server page

Overview This command displays the web-authentication page configuration and status.

Syntax show auth-web-server page

Mode Privileged Exec

Examples To show the web-authentication page information, use the command:

```
awplus# show auth-web-server page
```

Figure 41-10: Example output from the **show auth-web-server page** command

```
awplus#show auth-web-server page
Web authentication page
  Logo: auto
  Title: default
  Sub-Title: Web Authentication
  Welcome message: Your welcome message
  Success message: Your success message
```

Related commands

[auth-web forward](#)

[auth-web-server page logo](#)

[auth-web-server page sub-title](#)

[auth-web-server page success-message](#)

[auth-web-server page title](#)

[auth-web-server page welcome-message](#)

show proxy-autoconfig-file

Overview This command displays the contents of the proxy auto configuration (PAC) file.

Syntax show proxy-autoconfig-file

Mode Privileged Exec

Example To display the contents of the proxy auto configuration (PAC) file, enter the command:

```
awplus# show auth proxy-autoconfig-file
```

Output Figure 41-11: Example output from **show proxy-autoconfig-file**

```
function FindProxyForURL(url,host)
{
  if (isPlainHostName(host) ||
      isInNet(host, "192.168.1.0", "255.255.255.0")) {
    return "DIRECT";
  }
  else {
    return "PROXY 192.168.110.1:8080";
  }
}
```

Related commands [copy proxy-autoconfig-file](#)
[erase proxy-autoconfig-file](#)

Introduction

Overview AAA is the collective title for the three related functions of Authentication, Authorization and Accounting. These function can be applied in a variety of methods with a variety of servers.

The purpose of the AAA commands is to map instances of the AAA functions to sets of servers. The Authentication function can be performed in multiple contexts, such as authentication of users logging in at a console, or 802.1X-Authentication of devices connecting to Ethernet ports.

For each of these contexts, you may want to use different sets of servers for examining the proffered authentication credentials and deciding if they are valid. AAA Authentication commands enable you to specify which servers will be used for different types of authentication.

The AR2050V supports port authentication with the following limitations:

- MAC authentication is supported on the device's switch ports static channel-groups and dynamic (LACP) channel-groups.
- 802.1X authentication is supported on the device's switch ports only. It is not supported on static channel-groups and dynamic (LACP) channel-groups.
- Web authentication is supported on the device's Eth interfaces only.

This chapter provides an alphabetical reference for AAA commands for Authentication, Authorization and Accounting. For more information, see the [AAA and Port_Authentication Feature Overview and Configuration Guide](#).

- Command List**
- [“aaa accounting auth-mac”](#) on page 2232
 - [“aaa accounting auth-web”](#) on page 2234
 - [“aaa accounting commands”](#) on page 2236
 - [“aaa accounting dot1x”](#) on page 2238
 - [“aaa accounting login”](#) on page 2240
 - [“aaa accounting update”](#) on page 2243

- [“aaa authentication auth-mac”](#) on page 2245
- [“aaa authentication auth-web”](#) on page 2247
- [“aaa authentication dot1x”](#) on page 2249
- [“aaa authentication enable default group tacacs+”](#) on page 2251
- [“aaa authentication enable default local”](#) on page 2253
- [“aaa authentication isakmp”](#) on page 2254
- [“aaa authentication login”](#) on page 2255
- [“aaa authentication openvpn”](#) on page 2258
- [“aaa authorization commands”](#) on page 2260
- [“aaa authorization config-commands”](#) on page 2262
- [“aaa group server”](#) on page 2263
- [“aaa local authentication attempts lockout-time”](#) on page 2265
- [“aaa local authentication attempts max-fail”](#) on page 2266
- [“aaa login fail-delay”](#) on page 2267
- [“accounting login”](#) on page 2268
- [“authorization commands”](#) on page 2269
- [“clear aaa local user lockout”](#) on page 2271
- [“debug aaa”](#) on page 2272
- [“login authentication”](#) on page 2273
- [“proxy-port”](#) on page 2274
- [“radius-secure-proxy aaa”](#) on page 2275
- [“server \(radsecproxy-aaa\)”](#) on page 2276
- [“server mutual-authentication”](#) on page 2278
- [“server name-check”](#) on page 2279
- [“server trustpoint”](#) on page 2280
- [“show aaa local user locked”](#) on page 2282
- [“show aaa server group”](#) on page 2283
- [“show debugging aaa”](#) on page 2284
- [“show radius server group”](#) on page 2285
- [“undebug aaa”](#) on page 2287

aaa accounting auth-mac

Overview This command configures an accounting method list for MAC-based authentication. An accounting method list specifies what type of accounting messages are sent and which RADIUS servers the accounting messages are sent to. Use this command to configure either the default method list, which is automatically applied to interfaces with MAC-based authentication enabled, or a named method list, which can be applied to an interface with the [auth-mac accounting](#) command.

Use the **no** variant of this command to disable either the default or a named accounting method list for MAC-based authentication. Once all method lists are disabled, AAA accounting for MAC-based authentication is disabled globally.

Syntax

```
aaa accounting auth-mac {default|<list-name>}  
{start-stop|stop-only|none} group {<group-name>|radius}  
no aaa accounting auth-mac {default|<list-name>}
```

Parameter	Description
default	Configure the default accounting method list
<list-name>	Configure a named accounting method list
start-stop	Sends a start accounting message at the beginning of the session and a stop accounting message at the end of the session.
stop-only	Only sends a stop accounting message at the end of the session.
none	No accounting record sent.
group	Use a server group
<group-name>	Server group name.
radius	Use all RADIUS servers.

Default RADIUS accounting for MAC-based Authentication is disabled by default

Mode Global Configuration

Usage notes This command can be used to configure either the default accounting method list or a named accounting method list:

- **default:** the default accounting method list which is automatically applied to all interfaces with MAC-based authentication enabled.
- **<list-name>:** a user named list which can be applied to an interface using the [auth-mac accounting](#) command.

There are two ways to define servers where RADIUS accounting messages are sent:

- **group radius:** use all RADIUS servers configured by [radius-server host](#) command

- **group** <group-name>: use the specified RADIUS server group configured with the `aaa group server` command

The accounting event to send to the RADIUS server is configured with the following options:

- **start-stop**: sends a **start** accounting message at the beginning of a session and a **stop** accounting message at the end of the session.
- **stop-only**: sends a **stop** accounting message at the end of a session.
- **none**: disables accounting.

Examples To enable the default RADIUS accounting for MAC-based authentication, and use all available RADIUS servers, use the commands:

```
awplus# configure terminal
awplus(config)# aaa accounting auth-mac default start-stop
group radius
```

To disable RADIUS accounting for MAC-based Authentication, use the commands:

```
awplus# configure terminal
awplus(config)# no aaa accounting auth-mac default
```

To enable a named RADIUS accounting method list 'vlan10_acct' for MAC-based authentication, with the RADIUS server group 'rad_group_vlan10', use the commands:

```
awplus# configure terminal
awplus(config)# aaa accounting auth-mac vlan10_acct start-stop
group rad_group_vlan10
```

To disable a named RADIUS accounting method list 'vlan10_acct' for MAC-based authentication, use the commands:

```
awplus# configure terminal
awplus(config)# no aaa accounting auth-mac vlan10_acct
```

Related commands

- [aaa authentication auth-mac](#)
- [aaa group server](#)
- [auth-mac accounting](#)
- [auth-mac enable](#)
- [radius-server host](#)
- [show aaa server group](#)

aaa accounting auth-web

Overview This command configures an accounting method list for Web-based authentication. An accounting method list specifies what type of accounting messages are sent and which RADIUS servers the accounting messages are sent to. Use this command to configure either the default method list, which is automatically applied to interfaces with Web-based authentication enabled, or a named method list, which can be applied to an interface with the [auth-web accounting](#) command.

Use the **no** variant of this command to disable either the default or a named accounting method list for Web-based authentication. Once all method lists are disabled, AAA accounting for Web-based authentication is disabled globally.

Syntax

```
aaa accounting auth-web {default|<list-name>}  
{start-stop|stop-only|none} group {<group-name>|radius}  
no aaa accounting auth-web {default|<list-name>}
```

Parameter	Description
default	Configure the default accounting method list
<list-name>	Configure a named accounting method list
start-stop	Sends a start accounting message at the beginning of the session and a stop accounting message at the end of the session.
stop-only	Only sends a stop accounting message at the end of the session.
none	No accounting record sent.
group	Use a server group
<group-name>	Server group name.
radius	Use all RADIUS servers.

Default RADIUS accounting for Web-based authentication is disabled by default.

Mode Global Configuration

Usage notes This command can be used to configure either the default accounting method list or a named accounting method list:

- **default:** the default accounting method list which is automatically applied to all interfaces with Web-based authentication enabled.
- **<list-name>:** a user named list which can be applied to an interface using the [auth-web accounting](#) command.

There are two ways to define servers where RADIUS accounting messages are sent:

- **group radius:** use all RADIUS servers configured by [radius-server host](#) command

- **group** <group-name>: use the specified RADIUS server group configured with the `aaa group server` command

Configure the accounting event to be sent to the RADIUS server with the following options:

- **start-stop**: sends a start accounting message at the beginning of a session and a stop accounting message at the end of the session.
- **stop-only**: sends a stop accounting message at the end of a session.
- **none**: disables accounting.

Examples To enable the default RADIUS accounting method for Web-based authentication, and use all available RADIUS servers, use the commands:

```
awplus# configure terminal
awplus(config)# aaa accounting auth-web default start-stop
group radius
```

To disable the default RADIUS accounting method for Web-based authentication, use the commands:

```
awplus# configure terminal
awplus(config)# no aaa accounting auth-web default
```

To enable a named RADIUS accounting method list 'example_acct' for Web-based authentication, with the RADIUS server group 'rad_group_example', use the commands:

```
awplus# configure terminal
awplus(config)# aaa accounting auth-web example_acct start-stop
group rad_group_example
```

To disable a named RADIUS accounting method list 'example_acct' for Web-based authentication, use the commands:

```
awplus# configure terminal
awplus(config)# no aaa accounting auth-web example_acct
```

Related commands

- [aaa authentication auth-web](#)
- [aaa group server](#)
- [auth-web accounting](#)
- [auth-web enable](#)
- [radius-server host](#)
- [show aaa server group](#)

aaa accounting commands

Overview This command configures and enables TACACS+ accounting on commands entered at a specified privilege level. Once enabled for a privilege level, accounting messages for commands entered at that privilege level will be sent to a TACACS+ server.

In order to account for all commands entered on a device, configure command accounting for each privilege level separately.

The command accounting message includes, the command as entered, the date and time the command finished executing, and the user-name of the user who executed the command.

Use the **no** variant of this command to disable command accounting for a specified privilege level.

Syntax `aaa accounting commands <1-15> default stop-only group tacacs+`
`no aaa accounting commands <1-15> default`

Parameter	Description
<1-15>	The privilege level being configured, in the range 1 to 15.
default	Use the default method list, this means the command is applied globally to all user exec sessions.
stop-only	Send accounting message when the commands have stopped executing.
group	Specify the server group where accounting messages are sent. Only the tacacs+ group is available for this command.
tacacs+	Use all TACACS+ servers configured by the <code>tacacs-server host</code> command.

Default TACACS+ command accounting is disabled by default.

Mode Global Configuration

Usage notes This command only supports a **default** method list, this means that it is applied to every console and VTY line.

The **stop-only** parameter indicates that the command accounting messages are sent to the TACACS+ server when the commands have stopped executing.

The **group tacacs+** parameters signifies that the command accounting messages are sent to the TACACS+ servers configured by the `tacacs-server host` command.

Note that up to four TACACS+ servers can be configured for accounting. The servers are checked for reachability in the order they are configured with only the first reachable server being used. If no server is found, the accounting message is dropped.

Command accounting cannot coexist with triggers. An error message is displayed if you attempt to enable command accounting while a trigger is configured. Likewise, an error message is displayed if you attempt to configure a trigger while command accounting is configured.

Examples To configure command accounting for privilege levels 1, 7, and 15, use the following commands:

```
awplus# configure terminal
awplus(config)# aaa accounting commands 1 default stop-only
group tacacs+
awplus(config)# aaa accounting commands 7 default stop-only
group tacacs+
awplus(config)# aaa accounting commands 15 default stop-only
group tacacs+
```

To disable command accounting for privilege levels 1, 7, and 15, use the following commands:

```
awplus# configure terminal
awplus(config)# no aaa accounting commands 1 default
awplus(config)# no aaa accounting commands 7 default
awplus(config)# no aaa accounting commands 15 default
```

Related commands

- [aaa authentication login](#)
- [aaa accounting login](#)
- [accounting login](#)
- [tacacs-server host](#)

aaa accounting dot1x

Overview Use this command to configure an accounting method list for IEEE 802.1X-based authentication. An accounting method list specifies what type of accounting messages are sent and which RADIUS servers the accounting messages are sent to. Use this command to configure either the default method list, which is automatically applied to interfaces with IEEE 802.1X-based authentication enabled, or a named method list, which can be applied to an interface with the [dot1x accounting](#) command.

Use the **no** variant of this command to disable either the default or a named accounting method list for 802.1X-based authentication. Once all method lists are disabled, AAA accounting for 802.1x-based authentication is disabled globally.

Syntax

```
aaa accounting dot1x {default|<list-name>}  
{start-stop|stop-only|none} group {<group-name>|radius}  
no aaa accounting dot1x {default|<list-name>}
```

Parameter	Description
default	Configure the default accounting method list
<list-name>	Configure a named accounting method list
start-stop	Sends a start accounting message at the beginning of the session and a stop accounting message at the end of the session.
stop-only	Only sends a stop accounting message at the end of the session.
none	No accounting record sent.
group	Use a server group
<group-name>	Server group name.
radius	Use all RADIUS servers.

Default RADIUS accounting for 802.1X-based authentication is disabled by default (there is no default server set by default).

Mode Global Configuration

Usage notes This command can be used to configure either the default accounting method list or a named accounting method list:

- **default:** the default accounting method list which is automatically applied to all interfaces with 802.1X-based authentication enabled.
- **<list-name>:** a user named list which can be applied to an interface using the [dot1x accounting](#) command.

There are two ways to define servers where RADIUS accounting messages will be sent:

- **group radius:** use all RADIUS servers configured by [radius-server host](#) command.
- **group <group-name>:** use the specified RADIUS server group configured with the [aaa group server](#) command.

The accounting event to send to the RADIUS server is configured by the following options:

- **start-stop:** sends a **start** accounting message at the beginning of a session and a **stop** accounting message at the end of the session.
- **stop-only:** sends a **stop** accounting message at the end of a session.
- **none:** disables accounting.

Examples To enable RADIUS accounting for 802.1X-based authentication, and use all available RADIUS Servers, use the commands:

```
awplus# configure terminal
awplus(config)# aaa accounting dot1x default start-stop group
radius
```

To disable RADIUS accounting for 802.1X-based authentication, use the commands:

```
awplus# configure terminal
awplus(config)# no aaa accounting dot1x default
```

To enable a named RADIUS accounting method list 'vlan10_acct' for 802.1X-based authentication, with the RADIUS server group 'rad_group_vlan10', use the commands:

```
awplus# configure terminal
awplus(config)# aaa accounting dot1x vlan10_acct start-stop
group rad_group_vlan10
```

To disable a named RADIUS accounting method list 'vlan10_acct' for 802.1X-based authentication, use the commands:

```
awplus# configure terminal
awplus(config)# no aaa accounting dot1x vlan10_acct
```

**Related
commands**

[aaa accounting update](#)
[aaa authentication dot1x](#)
[aaa group server](#)
[dot1x accounting](#)
[dot1x port-control](#)
[radius-server host](#)
[show aaa server group](#)

**Command
changes**

Version 5.4.9-2.1: command added to AR2050V, AR3050S, and AR4050S

aaa accounting login

Overview This command configures RADIUS and TACACS+ accounting for login shell sessions. The specified method list name can be used by the **accounting login** command in the Line Configuration mode. If the **default** parameter is specified, then this creates a default method list that is applied to every console and VTY line, unless another accounting method list is applied on that line.

Note that unlimited RADIUS servers and up to four TACACS+ servers can be configured and consulted for accounting. The first server configured is regarded as the primary server and if the primary server fails then the backup servers are consulted in turn. A backup server is consulted if the primary server fails, i.e. is unreachable.

Use the **no** variant of this command to remove an accounting method list for login shell sessions configured by an **aaa accounting login** command. If the method list being deleted is already applied to a console or VTY line, accounting on that line will be disabled. If the default method list name is removed by this command, it will disable accounting on every line that has the default accounting configuration.

Syntax

```
aaa accounting login  
{default|<list-name>} {start-stop|stop-only|none} {group  
{radius|tacacs+|<group-name>}}  
  
no aaa accounting login {default|<list-name>}
```

Parameter	Description
default	Default accounting method list.
<list-name>	Named accounting method list.
start-stop	Start and stop records to be sent.
stop-only	Stop records to be sent.
none	No accounting record to be sent.
group	Specify the servers or server group where accounting packets are sent.
radius	Use all RADIUS servers configured by the radius-server host command.
tacacs+	Use all TACACS+ servers configured by the tacacs-server host command.
<group-name>	Use the specified RADIUS server group, as configured by the aaa group server command.

Default Accounting for login shell sessions is disabled by default.

Mode Global Configuration

Usage notes This command enables you to define a named accounting method list. The items that you define in the accounting options are:

- the types of accounting packets that will be sent
- the set of servers to which the accounting packets will be sent

You can define a default method list with the name **default** and any number of other named method lists. The name of any method list that you define can then be used as the *<list-name>* parameter in the [accounting login](#) command.

If the method list name already exists, the command will replace the existing configuration with the new one.

There are two ways to define servers where RADIUS accounting messages are sent:

- **group radius** : use all RADIUS servers configured by [radius-server host](#) command
- **group <group-name>** : use the specified RADIUS server group configured with the [aaa group server](#) command

There is one way to define servers where TACACS+ accounting messages are sent:

- **group tacacs+** : use all TACACS+ servers configured by [tacacs-server host](#) command

The accounting event to send to the RADIUS or TACACS+ server is configured with the following options:

- **start-stop** : sends a **start** accounting message at the beginning of a session and a **stop** accounting message at the end of the session.
- **stop-only** : sends a **stop** accounting message at the end of a session.
- **none** : disables accounting.

Examples To configure RADIUS accounting for login shell sessions, use the following commands:

```
awplus# configure terminal
awplus(config)# aaa accounting login default start-stop group
radius
```

To configure TACACS+ accounting for login shell sessions, use the following commands:

```
awplus# configure terminal
awplus(config)# aaa accounting login default start-stop group
tacacs+
```

To reset the configuration of the default accounting list, use the following commands:

```
awplus# configure terminal
awplus(config)# no aaa accounting login default
```

Related commands

- [aaa accounting commands](#)
- [aaa authentication login](#)
- [aaa accounting login](#)
- [accounting login](#)
- [radius-server host](#)
- [tacacs-server host](#)

aaa accounting update

Overview This command enables periodic accounting reporting to either the RADIUS or TACACS+ accounting server(s) wherever login accounting has been configured.

Note that unlimited RADIUS servers and up to four TACACS+ servers can be configured and consulted for accounting. The first server configured is regarded as the primary server and if the primary server fails then the backup servers are consulted in turn. A backup server is consulted if the primary server fails, i.e. is unreachable.

Use the **no** variant of this command to disable periodic accounting reporting to the accounting server(s).

Syntax `aaa accounting update [periodic <1-65535>]`
`no aaa accounting update`

Parameter	Description
<code>periodic</code>	Send accounting records periodically.
<code><1-65535></code>	The interval to send accounting updates (in minutes). The default is 30 minutes.

Default Disabled

Mode Global Configuration

Usage notes Use this command to enable the device to send periodic AAA login accounting reports to the accounting server. When periodic accounting reporting is enabled, interim accounting records are sent at the interval specified by the **periodic** parameter. The accounting updates are start messages.

If the **no** variant of this command is used to disable periodic accounting reporting, any interval specified by the **periodic** parameter is reset to the default of 30 minutes when accounting reporting is re-enabled, unless this interval is specified.

Examples To configure the switch to send period accounting updates every 30 minutes, the default period, use the following commands:

```
awplus# configure terminal
awplus(config)# aaa accounting update
```

To configure the switch to send period accounting updates every 10 minutes, use the following commands:

```
awplus# configure terminal
awplus(config)# aaa accounting update periodic 10
```

To disable periodic accounting updates wherever accounting has been configured, use the following commands:

```
awplus# configure terminal  
awplus(config)# no aaa accounting update
```

**Related
commands**

aaa accounting auth-mac
aaa accounting auth-web
aaa accounting dot1x
aaa accounting login
radius-server host

aaa authentication auth-mac

Overview This command enables MAC-based authentication globally and allows you to enable either the default authentication method list (in this case, a list of RADIUS servers), which is automatically applied to every interface running MAC-based authentication, or a user named authentication method list, which is applied to an interface with the [auth-mac authentication](#) command.

Use the **no** variant of this command to disable either the default or a named method list for MAC-based authentication. Once all method lists are disabled MAC-based authentication is disabled globally.

Syntax

```
aaa authentication auth-mac {default|<list-name>} group  
{<group-name>|radius}  
  
no aaa authentication auth-mac {default|<list-name>}
```

Parameter	Description
default	Configure the default authentication method list
<list-name>	Configure a named authentication method list
group	Use a server group
<group-name>	Server group name.
radius	Use all RADIUS servers.

Default MAC-based Port Authentication is disabled by default.

Mode Global Configuration

Usage notes This command can be used to configure either the default authentication method list or a named authentication method list:

- **default:** the default authentication method list which is automatically applied to all interfaces with Web-based authentication enabled.
- **<list-name>:** a user named list which can be applied to an interface using the [auth-web authentication](#) command.

There are two ways to define servers where RADIUS accounting messages are sent:

- **group radius:** use all RADIUS servers configured by [radius-server host](#) command
- **group <group-name>:** use the specified RADIUS server group configured with the [aaa group server](#) command

All configured RADIUS Servers are automatically members of the server group **radius**. If a server is added to a named group **<group-name>**, it also remains a member of the group **radius**.

Examples To enable MAC-based authentication globally for all RADIUS servers, and use all available RADIUS servers, use the commands:

```
awplus# configure terminal
awplus(config)# aaa authentication auth-mac default group
radius
```

To disable MAC-based authentication, use the commands:

```
awplus# configure terminal
awplus(config)# no aaa authentication auth-mac default
```

To enable MAC-based authentication for named list 'vlan10_auth', with RADIUS server group 'rad_group_vlan10, use the commands:

```
awplus# configure terminal
awplus(config)# aaa authentication auth-mac vlan10_auth group
rad_group_vlan10
```

To disable MAC-based authentication for named list 'vlan10_auth', use the commands:

```
awplus# configure terminal
awplus(config)# no aaa authentication auth-mac vlan10_acct
```

Related commands

- [aaa accounting auth-mac](#)
- [aaa group server](#)
- [auth-mac authentication](#)
- [auth-mac enable](#)
- [radius-server host](#)
- [show aaa server group](#)

aaa authentication auth-web

Overview This command enables Web-based authentication globally and allows you to enable either the default authentication method list (in this case, a list of RADIUS servers), which is automatically applied to every interface running Web-based authentication, or a user named authentication method list, which is applied to an interface with the [auth-web authentication](#) command.

Use the **no** variant of this command to disable either the default or a named method list for Web-based authentication. Once all method lists are disabled Web-based authentication is disabled globally.

Syntax

```
aaa authentication auth-web {default|<list-name>} group  
{<group-name>|radius}  
  
no aaa authentication auth-web {default|<list-name>}
```

Parameter	Description
default	Configure the default authentication method list
<list-name>	Configure a named authentication method list
group	Use a server group
<group-name>	Server group name.
radius	Use all RADIUS servers.

Default Web-based authentication is disabled by default.

Mode Global Configuration

Usage notes This command can be used to configure either the default authentication method list or a named authentication method list:

- **default:** the default authentication method list which is automatically applied to all interfaces with Web-based authentication enabled.
- **<list-name>:** a user named list which can be applied to an interface using the [auth-web authentication](#) command.

There are two ways to define servers where RADIUS accounting messages are sent:

- **group radius:** use all RADIUS servers configured by [radius-server host](#) command
- **group <group-name>:** use the specified RADIUS server group configured with the [aaa group server](#) command

Note that you need to configure an IPv4 address for the VLAN interface on which Web authentication is running.

Examples To enable Web-based authentication globally for all RADIUS servers, and use all available RADIUS servers, use the commands:

```
awplus# configure terminal
awplus(config)# aaa authentication auth-web default group
radius
```

To disable Web-based authentication, use the commands:

```
awplus# configure terminal
awplus(config)# no aaa authentication auth-web default
```

To enable Web-based authentication for named list 'example_auth', with RADIUS server group 'rad_group_example, use the commands:

```
awplus# configure terminal
awplus(config)# aaa authentication auth-web example_auth group
rad_group_example
```

To disable Web-based authentication for named list 'example_auth', use the commands:

```
awplus# configure terminal
awplus(config)# no aaa authentication example_auth
```

Related commands

- [aaa accounting auth-web](#)
- [aaa group server](#)
- [auth-web authentication](#)
- [radius-server host](#)

aaa authentication dot1x

Overview Use this command to enable IEEE 802.1X-based authentication globally and to allow you to enable either the default authentication method list (in this case, a list of RADIUS servers), which is automatically applied to every interface running IEEE 802.1X-based authentication, or a user named authentication method list, which is applied to an interface with the [dot1x authentication](#) command.

Use the **no** variant of this command to disable either the default or a named method list for 802.1X-based authentication. Once all method lists are disabled 802.1x-based authentication is disabled globally.

Syntax

```
aaa authentication dot1x {default|<list-name>} group  
{<group-name>|radius}  
  
no aaa authentication dot1x {default|<list-name>}
```

Parameter	Description
default	Configure the default authentication method list
<list-name>	Configure a named authentication method list
group	Use a server group
<group-name>	Server group name.
radius	Use all RADIUS servers.

Default 802.1X-based Port Authentication is disabled by default.

Mode Global Configuration

Usage notes This command can be used to configure either the default authentication method list or a named authentication method list:

- **default:** the default authentication method list which is automatically applied to all interfaces with 802.1X-based authentication enabled.
- **<list-name>:** a user named list which can be applied to an interface using the [aaa authentication dot1x](#) command.

There are two ways to define servers where RADIUS accounting messages are sent:

- **group radius:** use all RADIUS servers configured by [radius-server host](#) command
- **group <group-name>:** use the specified RADIUS server group configured with the [aaa group server](#) command

Examples To enable 802.1X-based authentication globally with all RADIUS servers, and use all available RADIUS servers, use the command:

```
awplus# configure terminal  
awplus(config)# aaa authentication dot1x default group radius
```

To disable 802.1X-based authentication, use the command:

```
awplus# configure terminal
awplus(config)# no aaa authentication dot1x default
```

To enable 802.1X-based authentication for named list 'vlan10_auth', with RADIUS server group 'rad_group_vlan10', use the commands:

```
awplus# configure terminal
awplus(config)# aaa authentication dot1x vlan10_auth group
rad_group_vlan10
```

To disable 802.1X-based authentication for named list 'vlan10_auth' use the commands:

```
awplus# configure terminal
awplus(config)# no aaa authentication dot1x vlan10_acct
```

**Related
commands**

[aaa accounting dot1x](#)
[aaa group server](#)
[dot1x authentication](#)
[dot1x port-control](#)
[radius-server host](#)
[show aaa server group](#)

**Command
changes**

Version 5.4.9-2.1: command added to AR2050V, AR3050S, and AR4050S

aaa authentication enable default group tacacs+

Overview This command enables privilege level authentication against a TACACS+ server. Use the **no** variant of this command to disable privilege level authentication.

Syntax `aaa authentication enable default group tacacs+ [local] [none]`
`no aaa authentication enable default`

Parameter	Description
local	Use the locally configured enable password (enable password command) for authentication.
none	No authentication.

Default Local privilege level authentication is enabled by default (`aaa authentication enable default local` command).

Mode Global Configuration

Usage notes A user is configured on a TACACS+ server with a maximum privilege level. When they enter the `enable` (**Privileged Exec mode**) command they are prompted for an enable password which is authenticated against the TACACS+ server. If the password is correct and the specified privilege level is equal to or less than the users maximum privilege level, then they are granted access to that level. If the user attempts to access a privilege level that is higher than their maximum configured privilege level, then the authentication session will fail and they will remain at their current privilege level.

NOTE: If both **local** and **none** are specified, you must always specify **local** first.

If the TACACS+ server goes offline, or is not reachable during enable password authentication, and command level authentication is configured as:

- **aaa authentication enable default group tacacs+**
then the user is never granted access to Privileged Exec mode.
- **aaa authentication enable default group tacacs+ local**
then the user is authenticated using the locally configured enable password, which if entered correctly grants the user access to Privileged Exec mode. If no enable password is locally configured (**enable password** command), then the enable authentication will fail until the TACACS+ server becomes available again.

- **aaa authentication enable default group tacacs+ none**
then the user is granted access to Privileged Exec mode with no authentication. This is true even if a locally configured enable password is configured.
- **aaa authentication enable default group tacacs+ local none**
then the user is authenticated using the locally configured enable password. If no enable password is locally configured, then the enable authentication will grant access to Privileged Exec mode with no authentication.

If the password for the user is not successfully authenticated by the server, then the user is again prompted for an enable password when they enter **enable** via the CLI.

Examples To enable a privilege level authentication method that will not allow the user to access Privileged Exec mode if the TACACS+ server goes offline, or is not reachable during enable password authentication, use the following commands:

```
awplus# configure terminal
awplus(config)# aaa authentication enable default group tacacs+
```

To enable a privilege level authentication method that will allow the user to access Privileged Exec mode if the TACACS+ server goes offline, or is not reachable during enable password authentication, and a locally configured enable password is configured, use the following commands:

```
awplus# configure terminal
awplus(config)# aaa authentication enable default group tacacs+
local
```

To disable privilege level authentication, use the following commands:

```
awplus# configure terminal
awplus(config)# no aaa authentication enable default
```

Related commands

- [aaa authentication login](#)
- [aaa authentication enable default local](#)
- [enable \(Privileged Exec mode\)](#)
- [enable password](#)
- [enable secret \(deprecated\)](#)
- [tacacs-server host](#)

aaa authentication enable default local

Overview This command enables local privilege level authentication.
Use the **no** variant of this command to disable local privilege level authentication.

Syntax `aaa authentication enable default local`
`no aaa authentication enable default`

Default Local privilege level authentication is enabled by default.

Mode Global Configuration

Usage notes The privilege level configured for a particular user in the local user database is the privilege threshold above which the user is prompted for an [enable \(Privileged Exec mode\)](#) command.

Examples To enable local privilege level authentication, use the following commands:

```
awplus# configure terminal
awplus(config)# aaa authentication enable default local
```

To disable local privilege level authentication, use the following commands:

```
awplus# configure terminal
awplus(config)# no aaa authentication enable default
```

Related commands [aaa authentication login](#)
[enable \(Privileged Exec mode\)](#)
[enable password](#)
[enable secret \(deprecated\)](#)

aaa authentication isakmp

Overview Use this command to enable global RADIUS authentication for ISAKMP tunnels. Use the **no** variant of this command to disable global RADIUS authentication of ISAKMP tunnels.

Syntax `aaa authentication isakmp default group [<group-name>|radius]`
`no aaa authentication isakmp default`

Parameter	Description
<code><group-name></code>	Server group name
<code>radius</code>	Use all RADIUS servers

Default Disabled

Mode Global Configuration

Usage notes When RADIUS authentication is enabled globally to ISAKMP tunnels it is automatically applied to every ISAKMP tunnel interface. There are two ways to define servers where radius accounting messages are sent:

- Group `radius`, where all RADIUS servers configured using this command are used
- Group `<group-name>`, where the specified RADIUS server group configured is used

Examples To enable RADIUS authentication for ISAKMP tunnels globally and use all available radius servers, use the commands:

```
awplus# configure terminal
awplus(config)# aaa authentication isakmp default group radius
```

To disable RADIUS authentication for ISAKMP tunnels, use the commands:

```
awplus# configure terminal
awplus(config)# no authentication isakmp default
```

Related commands [radius-server host](#)
[aaa group server](#)

Command changes Version 5.4.9-0.1: command added

aaa authentication login

Overview Use this command to create an ordered list of methods for authenticating user logins. It can also be used to replace an existing method list with a list of the same name. Specify one or more of the options **local** or **group**, in the order you want them to be applied. If the **default** method list name is specified, it is applied to every console and VTY line immediately unless another method list is applied to that line by the [login authentication](#) command. To apply a non-default method list, you must also use the [login authentication](#) command.

Use the **no** variant of this command to remove a method list from user login authentication. The specified method list name is deleted from the configuration. If the method list name has been applied to any console or VTY line, user login authentication on that line will fail.

Note that the **no aaa authentication login default** command does not remove the default method list. This will return the default method list to its default state (**local** is the default).

Syntax

```
aaa authentication login {default|<list-name>} {[local] [group  
{radius|ldap|tacacs+|<group-name>}]}  
no aaa authentication login {default|<list-name>}
```

Parameter	Description
default	Set the default authentication server for user login.
<list-name>	Name of authentication server.
local	Use the local username database.
group	Use server group.
radius	Use all RADIUS servers configured by the radius-server host command.
ldap	Use all LDAP servers configured by the ldap-server command.
tacacs+	Use all TACACS+ servers configured by the tacacs-server host command.
<group-name>	Use the specified RADIUS or LDAP server group.

Default If the default server is not configured using this command, user login authentication uses the local user database only.

If the **default** method list name is specified, it is applied to every console and VTY line immediately unless a named method list server is applied to that line by the **login authentication** command.

local is the default state for the default method list unless a named method list is applied to that line by the **login authentication** command. You can reset it to the default method list using the **no aaa authentication login default** command.

Mode Global Configuration

Usage notes When a user attempts to log in, the switch sends an authentication request to the first authentication server in the method list. If the first server in the list is reachable and it contains a username and password matching the authentication request, the user is authenticated and the login succeeds. If the authentication server denies the authentication request because of an incorrect username or password, the user login fails. If the first server in the method list is unreachable, the switch sends the request to the next server in the list, and so on.

For example, if the method list specifies **group tacacs+ local**, and a user attempts to log in with a password that does not match a user entry in the first TACACS+ server, if this TACACS+ server denies the authentication request, then the switch does not try any other TACACS+ servers nor the local user database; the user login fails.

Examples To configure the default authentication method list for user login to first use all available RADIUS servers for user login authentication, and then use the local user database, use the following commands:

```
awplus# configure terminal
awplus(config)# aaa authentication login default group radius
local
```

To configure the default authentication method list for user login to first use all available LDAP servers for user login authentication, and then use the local user database, use the following commands:

```
awplus# configure terminal
awplus(config)# aaa authentication login default group ldap
local
```

To configure a user login authentication method list called 'USERS' to first use the RADIUS server group 'RAD_GROUP1' for user login authentication, and then use the local user database, use the following commands:

```
awplus# configure terminal
awplus(config)# aaa authentication login USERS group RAD_GROUP1
local
```

To configure a user login authentication method list called 'USERS' to first use the TACACS+ servers for user login authentication, and then use the local user database, use the following commands:

```
awplus# configure terminal
awplus(config)# aaa authentication login USERS group tacacs+
local
```

To return to the default method list (**local** is the default server), use the following commands:

```
awplus# configure terminal
awplus(config)# no aaa authentication login default
```

To delete an existing authentication method list 'USERS' created for user login authentication, use the following commands:

```
awplus# configure terminal  
awplus(config)# no aaa authentication login USERS
```

**Related
commands**

[aaa accounting commands](#)
[aaa authentication enable default group tacacs+](#)
[ldap-server](#)
[login authentication](#)
[radius-server host](#)

**Command
changes**

Version 5.5.2-1.1: **ldap** parameter added

aaa authentication openvpn

Overview Use this command to globally enable authentication, and set the default authentication method, on OpenVPN tunnels. The default authentication method can be:

- all configured RADIUS servers,
- all configured LDAP servers,
- or a user-defined group of RADIUS or LDAP servers.

In addition, you can optionally specify that two-factor authentication (2FA) is required on OpenVPN connections.

Use the **no** variant of this command to globally disable authentication on OpenVPN tunnels.

Syntax

```
aaa authentication openvpn default group
{<group-name>|radius|ldap} [2fa [2fa-in-password]]
no aaa authentication openvpn default
```

Parameter	Description
<code><group-name></code>	Server group name.
<code>radius</code>	Use all RADIUS servers.
<code>ldap</code>	Use all LDAP servers.
<code>2fa</code>	Require two-factor authentication (2FA).
<code>2fa-in-password</code>	Include the 2FA verification code in the password.

Default Authentication on OpenVPN tunnels is disabled by default.

Mode Global Configuration

Usage notes There are a number of ways to define groups of authentication servers. These are:

- **group radius:** use all RADIUS servers configured with the [radius-server host](#) command.
- **group ldap:** use all LDAP servers configured with the [ldap-server](#) command.
- **group <group-name>:** use the specified RADIUS or LDAP server group configured with the [aaa group server](#) command.

The **2fa** parameter allows you to strengthen security by requiring a second method of authentication. It requires a software-based authenticator that implements the time-based one-time password (TOTP) or HMAC-based one-time password (HOTP) algorithms. These software authenticators (known as authenticator apps) are usually loaded on a mobile device. One well-known implementation of such an app is Google Authenticator.

The **2fa-in-password** parameter allows the user to enter their 2FA authentication code straight after their password in the password field of the OpenVPN client. For example, if their password is 'secret' and their OpenVPN code is '654321', they will enter 'secret654321' into the OpenVPN client's password field.

Examples To enable RADIUS authentication on OpenVPN tunnels and use all available RADIUS servers, use the commands:

```
awplus# configure terminal
awplus(config)# aaa authentication openvpn default group radius
```

To enable authentication on OpenVPN tunnels using the servers in group 'GROUP2', use the commands:

```
awplus# configure terminal
awplus(config)# aaa authentication openvpn default group GROUP2
```

Note: This could be a group of RADIUS or LDAP servers.

To enable LDAP authentication on OpenVPN tunnels, use all available LDAP servers, and require 2FA with the 2FA code in the password field, use the commands:

```
awplus# configure terminal
awplus(config)# aaa authentication openvpn default group ldap
2fa 2fa-in-password
```

To disable authentication on OpenVPN tunnels, use the commands:

```
awplus# configure terminal
awplus(config)# no aaa authentication openvpn default
```

Related commands [aaa group server](#)
[radius-server host](#)

Command changes Version 5.5.2-1.1: **ldap** and **2fa** parameters added

aaa authorization commands

Overview This command configures a method list for commands authorization that can be applied to console or VTY lines. When command authorization is enabled for a privilege level, only authorized users can executed commands in that privilege level.

Use the **no** variant of this command to remove a named method list or disable the default method list for a privilege level.

Syntax

```
aaa authorization commands <privilege-level>
{default|<list-name>} group tacacs+ [none]

no aaa authorization commands <privilege-level>
{default|<list-name>}
```

Parameter	Description
<privilege-level>	The privilege level of the set of commands the method list will be applied to. AlliedWare Plus defines three sets of commands, that are indexed by a level value: Level = 1: All commands that can be accessed by a user with privilege level between 1 and 6 inclusive Level = 7: All commands that can be accessed by a user with privilege level between 7 and 14 inclusive Level = 15: All commands that can be accessed by a user with privilege level 15
group	Specify the server group where authorization messages are sent. Only the <code>tacacs+</code> group is available for this command.
tacacs+	Use all TACACS+ servers configured by the <code>tacacs-server host</code> command.
default	Configure the default authorization commands method list.
<list-name>	Configure a named authorization commands method list
none	If specified, this provides a local fallback to command authorization so that if authorization servers become unavailable then the device will accept all commands normally allowed for the privilege level of the user.

Mode Global Configuration

Usage notes TACACS+ command authorization provides centralized control of the commands available to a user of an AlliedWare Plus device. Once enabled:

- The command string and username are encrypted and sent to the first available configured TACACS+ server (the first server configured) for authorization.

- The TACACS+ server decides if the user is authorized to execute the command and returns the decision to the AlliedWare Plus device.
- Depending on this decision the device will then either execute the command or notify the user that authorization has failed.

If multiple TACACS+ servers are configured, and the first server is unreachable or does not respond, the other servers will be queried, in turn, for an authorization decision. If all servers are unreachable and a local fallback has been configured, with the **none** parameter, then commands are authorized based on the user's privilege level; the same behavior as if command authorization had not been configured. If, however, the local fallback is not configured and all servers become unreachable then all commands except **logout**, **exit**, and **quit** will be denied.

The **default** method list is defined with a local fallback unless configured differently using this command.

Example To configure a commands authorization method list, named TAC15, using all TACACS+ servers to authorize commands for privilege level 15, with a local fallback, use the following commands:

```
awplus# configure terminal
awplus(config)# aaa authorization commands 15 TAC15 group
tacacs+ none
```

To configure the default method list to authorize commands for privilege level 7, with no local fallback, use the following commands:

```
awplus# configure terminal
awplus(config)# aaa authorization commands 7 default group
tacacs+
```

To remove the authorization method list TAC15, use the following commands:

```
awplus# configure terminal
awplus(config)# no aaa authorization commands 15 TAC15
```

Related commands [aaa authorization config-commands](#)
[authorization commands](#)
[tacacs-server host](#)

Command changes Version 5.4.6-2.1: command added

aaa authorization config-commands

Overview Use this command to enable command authorization on configuration mode commands. By default, command authorization applies to commands in exec mode only.

Use the **no** variant of this command to disable command authorization on configuration mode commands.

Syntax `aaa authorization config-commands`
`no aaa authorization config-commands`

Default By default, command authorization is disabled on configuration mode commands.

Mode Global Configuration

Usage notes If authorization of configuration mode commands is not enabled then all configuration commands are accepted by default, including command authorization commands.

NOTE: *Authorization of configuration commands is required for a secure TACACS+ command authorization configuration as it prevents the feature from being disabled to gain access to unauthorized exec mode commands.*

Example To enable command authorization for configuration mode commands, use the commands:

```
awplus# configure terminal
awplus(config)# aaa authorization config-commands
```

To disable command authorization for configuration mode commands, use the commands:

```
awplus# configure terminal
awplus(config)# no aaa authorization config-commands
```

Related commands [aaa authorization commands](#)
[authorization commands](#)
[tacacs-server host](#)

Command changes Version 5.4.6-2.1: command added

aaa group server

Overview Use this command to create an AAA group of RADIUS or LDAP servers, and to enter Server Group Configuration mode.

A server group is used to specify a subset of RADIUS or LDAP servers in AAA commands. Once in Server Group Configuration mode you can add servers to the group.

Use the **no** variant of this command to remove an existing server group.

Syntax `aaa group server {radius|ldap} <group-name>`
`no aaa group server {radius|ldap} <group-name>`

Parameter	Description
radius	Create or configure a RADIUS server group.
ldap	Create or configure an LDAP server group.
<group-name>	Server group name.

Mode Global Configuration

Usage notes To add servers to a RADIUS or LDAP server group, use the **server** command. Each RADIUS server in a server group must be configured using the [radius-server host](#) command. Similarly, each LDAP server in a server group must be configured using the [ldap-server](#) command.

Server groups named 'radius' and 'ldap' are predefined and include all RADIUS and LDAP servers configured using the [radius-server host](#) or [ldap-server](#) commands.

Examples To create a RADIUS server group named 'GROUP1' with hosts 192.168.1.1, 192.168.2.1 and 192.168.3.1, use the commands:

```
awplus(config)# aaa group server radius GROUP1
awplus(config-sg)# server 192.168.1.1 auth-port 1812 acct-port 1813
awplus(config-sg)# server 192.168.2.1 auth-port 1812 acct-port 1813
awplus(config-sg)# server 192.168.3.1 auth-port 1812 acct-port 1813
```

To remove a RADIUS server group named 'GROUP1' from the configuration, use the command:

```
awplus(config)# no aaa group server radius GROUP1
```

To create an LDAP server group named 'GROUP2' with servers named 'SERVER1', 'SERVER2' and 'SERVER3', use the commands:

```
awplus(config)# aaa group server ldap GROUP2
awplus(config-ldap-group)# server SERVER1
awplus(config-ldap-group)# server SERVER2
awplus(config-ldap-group)# server SERVER3
```

To remove an LDAP server group named 'GROUP2' from the configuration, use the command:

```
awplus(config)# no aaa group server ldap GROUP2
```

**Related
commands**

[aaa accounting auth-mac](#)
[aaa accounting auth-web](#)
[aaa accounting dot1x](#)
[aaa accounting login](#)
[aaa authentication auth-mac](#)
[aaa authentication auth-web](#)
[aaa authentication dot1x](#)
[aaa authentication login](#)
[ldap-server](#)
[radius-server host](#)
[server \(ldap-group\)](#)
[server \(RADIUS server group\)](#)
[show ldap server group](#)
[show radius server group](#)

**Command
changes**

Version 5.5.2-1.1: **ldap** parameter added

aaa local authentication attempts lockout-time

Overview This command configures the duration of the user lockout period.

Use the **no** variant of this command to restore the duration of the user lockout period to its default of 300 seconds (5 minutes).

Syntax `aaa local authentication attempts lockout-time <lockout-time>`
`no aaa local authentication attempts lockout-time`

Parameter	Description
<code><lockout-time></code>	<code><0-10000></code> . Time in seconds to lockout the user.

Mode Global Configuration

Default The default for the lockout-time is 300 seconds (5 minutes).

Usage notes While locked out all attempts to login with the locked account will fail. The lockout can be manually cleared by another privileged account using the [clear aaa local user lockout](#) command.

Examples To configure the lockout period to 10 minutes (600 seconds), use the commands:

```
awplus# configure terminal
awplus(config)# aaa local authentication attempts lockout-time
600
```

To restore the default lockout period of 5 minutes (300 seconds), use the commands:

```
awplus# configure terminal
awplus(config)# no aaa local authentication attempts
lockout-time
```

Related commands [aaa local authentication attempts max-fail](#)

aaa local authentication attempts max-fail

Overview This command configures the maximum number of failed login attempts before a user account is locked out. Every time a login attempt fails the failed login counter is incremented.

Use the **no** variant of this command to restore the maximum number of failed login attempts to the default setting (five failed login attempts).

Syntax `aaa local authentication attempts max-fail <failed-logins>`
`no aaa local authentication attempts max-fail`

Parameter	Description
<code><failed-logins></code>	<code><1-32></code> . Number of login failures allowed before locking out a user.

Mode Global Configuration

Default The default for the maximum number of failed login attempts is five failed login attempts.

Usage When the failed login counter reaches the limit configured by this command that user account is locked out for a specified duration configured by the [aaa local authentication attempts lockout-time](#) command.

When a successful login occurs the failed login counter is reset to 0. When a user account is locked out all attempts to login using that user account will fail.

Examples To configure the number of login failures that will lock out a user account to two login attempts, use the commands:

```
awplus# configure terminal
awplus(config)# aaa local authentication attempts max-fail 2
```

To restore the number of login failures that will lock out a user account to the default number of login attempts (five login attempts), use the commands:

```
awplus# configure terminal
awplus(config)# no aaa local authentication attempts max-fail
```

Related commands [aaa local authentication attempts lockout-time](#)
[clear aaa local user lockout](#)

aaa login fail-delay

Overview Use this command to configure the minimum time period between failed login attempts. This setting applies to login attempts via the console, SSH and Telnet. Use the **no** variant of this command to reset the minimum time period to its default value.

Syntax `aaa login fail-delay <1-10>`
`no aaa login fail-delay`

Parameter	Description
<1-10>	The minimum number of seconds required between login attempts

Default 1 second

Mode Global configuration

Example To apply a delay of at least 5 seconds between login attempts, use the following commands:

```
awplus# configure terminal
awplus(config)# aaa login fail-delay 5
```

Related commands [aaa authentication login](#)
[aaa local authentication attempts lockout-time](#)
[clear aaa local user lockout](#)

accounting login

Overview This command applies a login accounting method list to console or VTY lines for user login. When login accounting is enabled using this command, logging events generate an accounting record to the accounting server.

The accounting method list must be configured first using this command. If an accounting method list is specified that has not been created by this command then accounting will be disabled on the specified lines.

The **no** variant of this command resets AAA Accounting applied to console or VTY lines for local or remote login. **default** login accounting is applied after issuing the **no accounting login** command. Accounting is disabled with **default**.

Syntax `accounting login {default|<list-name>}`
`no accounting login`

Parameter	Description
default	Default accounting method list.
<list-name>	Named accounting method list.

Default By default login accounting is disabled in the **default** accounting server. No accounting will be performed until accounting is enabled using this command.

Mode Line Configuration

Examples To apply the accounting server `USERS` to all VTY lines, use the following commands:

```
awplus# configure terminal
awplus(config)# line vty 0 32
awplus(config-line)# accounting login USERS
```

To reset accounting for login sessions on the console, use the following commands:

```
awplus# configure terminal
awplus(config)# line console 0
awplus(config-line)# no accounting login
```

Related commands [aaa accounting commands](#)
[aaa accounting login](#)

authorization commands

Overview This command applies a command authorization method list, defined using the [aaa authorization commands](#) command, to console and VTY lines.

Use the **no** variant of this command to reset the command authorization configuration on the console and VTY lines.

Syntax `authorization commands <privilege-level> {default|<list-name>}`
`no authorization commands <privilege-level>`

Parameter	Description
<code><privilege-level></code>	The privilege level of the set of commands the method list will be applied to. AlliedWare Plus defines three sets of commands, that are indexed by a level value: Level = 1: All commands that can be accessed by a user with privilege level between 1 and 6 inclusive Level = 7: All commands that can be accessed by a user with privilege level between 7 and 14 inclusive Level = 15: All commands that can be accessed by a user with privilege level 15
<code>default</code>	Configure the default authorization commands method list.
<code><list-name></code>	Configure a named authorization commands method list

Default The **default** method list is applied to each console and VTY line by default.

Mode Line Configuration

Usage notes If the specified method list does not exist users will not be able to execute any commands in the specified method list on the specified VTY lines.

Example To apply the TAC15 command authorization method list with privilege level 15 to VTY lines 0 to 5, use the following commands:

```
awplus# configure terminal
awplus(config)# line vty 0 5
awplus(config-line)# authorization commands 15 TAC15
```

To reset the command authorization configuration with privilege level 15 on VTY lines 0 to 5, use the following commands:

```
awplus# configure terminal
awplus(config)# line vty 0 5
awplus(config-line)# no authorization commands 15
```

Related commands [aaa authorization commands](#)

aaa authorization config-commands

tacacs-server host

Command changes Version 5.4.6-2.1: command added

clear aaa local user lockout

Overview Use this command to clear the lockout on a specific user account or all user accounts.

Syntax `clear aaa local user lockout {username <username>|all}`

Parameter	Description
username	Clear lockout for the specified user.
<username>	Specifies the user account.
all	Clear lockout for all user accounts.

Mode Privileged Exec

Examples To unlock the user account 'bob' use the following command:

```
awplus# clear aaa local user lockout username bob
```

To unlock all user accounts use the following command:

```
awplus# clear aaa local user lockout all
```

Related commands [aaa local authentication attempts lockout-time](#)

debug aaa

Overview This command enables AAA debugging.
Use the **no** variant of this command to disable AAA debugging.

Syntax debug aaa [accounting|all|authentication|authorization]
no debug aaa [accounting|all|authentication|authorization]

Parameter	Description
accounting	Accounting debugging.
all	All debugging options are enabled.
authentication	Authentication debugging.
authorization	Authorization debugging.

Default AAA debugging is disabled by default.

Mode Privileged Exec

Examples To enable authentication debugging for AAA, use the command:

```
awplus# debug aaa authentication
```

To disable authentication debugging for AAA, use the command:

```
awplus# no debug aaa authentication
```

Related commands [show debugging aaa](#)
[undebug aaa](#)

login authentication

Overview Use this command to apply an AAA server for authenticating user login attempts from a console or remote logins on these console or VTY lines. The authentication method list must be specified by the **aaa authentication login** command. If the method list has not been configured by the **aaa authentication login** command, login authentication will fail on these lines.

Use the **no** variant of this command to reset AAA Authentication configuration to use the default method list for login authentication on these console or VTY lines.

Command Syntax

```
login authentication {default|<list-name>}  
no login authentication
```

Parameter	Description
default	The default authentication method list. If the default method list has not been configured by the aaa authentication login command, the local user database is used for user login authentication.
<list-name>	Named authentication server.

Default The default login authentication method list, as specified by the [aaa authentication login](#) command, is used to authenticate user login. If this has not been specified, the default is to use the local user database.

Mode Line Configuration

Examples To apply the authentication method list called `CONSOLE` to the console port terminal line (asyn 0), use the following commands:

```
awplus# configure terminal  
awplus(config)# line console 0  
awplus(config-line)# login authentication CONSOLE
```

To reset user authentication configuration on all VTY lines, use the following commands:

```
awplus# configure terminal  
awplus(config)# line vty 0 32  
awplus(config-line)# no login authentication
```

Related commands [aaa authentication login](#)
[line](#)

proxy-port

Overview Use this command to change the local UDP port used for communication between local RADIUS client applications and the RadSecProxy AAA application. Any unused UDP port may be selected. The default port is 1645.

Use the **no** variant of this command to change the UDP port back to the default of 1645.

Syntax `proxy-port <port>`
`no proxy-port`

Parameter	Description
<code><port></code>	UDP Port Number, 1-65536.

Default The default port is 1645.

Mode RadSecProxy AAA Configuration Mode

Usage notes It is not necessary to change the value from the default unless UDP port 1645 is required for another purpose. RADIUS requests received on this port from external devices will be ignored. The port is only used for local (intra-device) communication.

Example To configure change the UDP port to 7001, use the following commands:

```
awplus# configure terminal
awplus(config)# radius-secure-proxy aaa
awplus(config-radsecproxy-aaa)# proxy-port 7001
```

Related commands [radius-secure-proxy aaa](#)
[server \(radsecproxy-aaa\)](#)
[server name-check](#)
[server trustpoint](#)

radius-secure-proxy aaa

Overview Use this command to enter the RadSecProxy AAA (authentication, authorization, and accounting) application configuration mode. This application allows local RADIUS-based clients on system to communicate with remote RadSec servers via a secure (TLS) proxy.

Syntax `radius-secure-proxy aaa`

Mode Global Configuration Mode

Example To change mode from User Exec mode to the RadSecProxy AAA configuration mode, use the commands:

```
awplus# configure terminal
awplus(config)# radius-secure-proxy aaa
awplus(config-radsecproxy-aaa)#
```

Related commands

- [proxy-port](#)
- [server \(radsecproxy-aaa\)](#)
- [server name-check](#)
- [server trustpoint](#)

server (radsecproxy-aaa)

Overview Use this command to add a server to the RadSecProxy AAA application. Local RADIUS client applications will attempt, via the proxy, to communicate with any RadSec servers that are operational (in addition to any non-TLS RADIUS servers that are configured).

Use the **no** variant of this command to delete a previously-configured server from the RadSecProxy AAA application.

Syntax `server {<hostname>|<ip-addr>} [timeout <1-1000>] [name-check {on|off}]`

`no server {<hostname>|<ip-addr>}`

Parameter	Description
<code><hostname></code>	Hostname of RadSec server
<code><ip-addr></code>	Specify the client IPv4 address, in dotted decimal notation (A.B.C.D).
<code>timeout</code>	Specify the amount of time that the RadSecProxy AAA application should wait for replies from this server. RADIUS server timeout (which defaults to 5 seconds).
<code><1-1000></code>	Time in seconds to wait for a server reply.
<code>name-check</code>	Specify whether or not to enforce certificate name checking for this client. If the parameter is not specified then the global behavior, which defaults to on , is used.
<code>on</code>	Enable name checking for this client.
<code>off</code>	Disable name checking for this client.

Mode RadSecProxy AAA Configuration Mode

Usage notes The server may be specified by its domain name or by its IPv4 address. If a domain name is used, it must be resolvable using a configured DNS name server.

Each server may be configured with a timeout; if not specified, the global timeout value for RADIUS servers will be used. The global timeout may be changed using the **radius-server timeout** command. The default global timeout is 5 seconds.

Each server may be configured to use certificate name-checking; if not specified, the global behavior defined by **server name-check** or **no server name-check** will be used. If name checking is enabled, the Common Name portion of the subject field of the server's X.509 certificate must match the domain name or IP address specified in this command.

Example To add a server 'mynas.local' with a timeout of 3 seconds, and name checking off, use the commands:

```
awplus# configure terminal
awplus(config)# radius-secure-proxy aaa
awplus(config-radsecproxy-aaa)# server mynas.local name-check
off
```

Related commands

- [proxy-port](#)
- [radius-secure-proxy aaa](#)
- [server name-check](#)
- [server trustpoint](#)

server mutual-authentication

Overview This command enables or disables mutual certificate authentication for all RadSecProxy servers. When enabled, the RadSecProxy AAA application will send a local X.509 certificate to the server when establishing a TLS connection.

Use the **no** variant of this command to disable mutual certificate validation causing the RadSecProxy AAA application to not transmit a certificate to the server.

NOTE: *If mutual authentication is disabled on the client (AAA) application but enabled on the server, a connection will not be established.*

Syntax `server mutual-authentication`
`no server mutual-authentication`

Default Mutual authentication is enabled by default.

Mode RadSecProxy AAA Configuration Mode

Example Disable mutual certificate validation with the following command:

```
awplus# configure terminal
awplus(config)# radius-secure-proxy aaa
awplus(config-radsecproxy-aaa)# no server
mutual-authentication
```

Related commands [radius-secure-proxy aaa](#)
[server name-check](#)
[server \(radsecproxy-aaa\)](#)

Command changes Version 5.4.6-2.1: command added

server name-check

Overview This command sets the global behavior for certificate name-checking for the RadSecProxy AAA application to **on**. This behavior will be used for all servers associated with the application that do not specify a behavior on a per-server basis. If name-checking is enabled, the Common Name portion of the subject field of the client's X.509 certificate must match the domain name or IP address specified in the **server (radsecproxy-aaa)** command.

Use the **no** variant of this command to set the global behavior for certificate name checking to **off**

Syntax `server name-check`
`no server name-check`

Default Certificate name checking is on by default.

Mode RadSecProxy AAA Configuration Mode

Example Disable certificate name checking globally with the following command:

```
awplus# configure terminal
awplus(config)# radius-secure-proxy aaa
awplus(config-radsecproxy-aaa)# no server name-check
```

Related commands [proxy-port](#)
[radius-secure-proxy aaa](#)
[server \(radsecproxy-aaa\)](#)
[server trustpoint](#)

server trustpoint

Overview This command adds one or more trustpoints to be used with the RadSecProxy AAA application. Multiple trustpoints may be specified, or the command may be executed more than once, to add multiple trustpoints to the application.

The **no** version of this command removes one or more trustpoints from the list of trustpoints associated with the application.

Syntax `server trustpoint [<trustpoint-list>]`
`no server trustpoint [<trustpoint-list>]`

Parameter	Description
<trustpoint-list>	Specify one or more trustpoints to be added or deleted.

Default By default, no trustpoints are associated with the application.

Mode RadSecProxy AAA Configuration Mode

Usage notes The device certificate associated with first trustpoint added to the application will be transmitted to remote servers. The certificate received from the remote server must have an issuer chain that terminates with the root CA certificate for any of the trustpoints that are associated with the application.

If no trustpoints are specified in the command, the trustpoint list will be unchanged.

If **no server trustpoint** is issued without specifying any trustpoints, then all trustpoints will be disassociated from the application.

Example You can add multiple trustpoints to the RadSecProxy AAA application by executing the command multiple times:

```
awplus# configure terminal
awplus(config)# radius-secure-proxy aaa
awplus(config-radsecproxy-aaa)# server trustpoint example_1
awplus(config-radsecproxy-aaa)# server trustpoint example_2
```

Alternatively, add multiple trustpoints with a single command:

```
awplus(config-radsecproxy-aaa)# server trustpoint example_3
example_4
```

Disassociate all trustpoints from the RadSecProxy AAA application using the command:

```
awplus(config-radsecproxy-aaa)# no server trustpoint
```

Related commands [proxy-port](#)
[radius-secure-proxy aaa](#)

server (radsecproxy-aaa)
server name-check

show aaa local user locked

Overview This command displays the current number of failed attempts, last failure time and location against each user account attempting to log into the device.

Note that once the lockout count has been manually cleared by another privileged account using the [clear aaa local user lockout](#) command or a locked account successfully logs into the system after waiting for the lockout time, this command will display nothing for that particular account.

Syntax `show aaa local user locked`

Mode User Exec and Privileged Exec

Example To display the current failed attempts for local users, use the command:

```
awplus# show aaa local user locked
```

Output Figure 42-1: Example output from the **show aaa local user locked** command

```
awplus# show aaa local user locked
Login          Failures Latest failure      From
bob            3      05/23/14 16:21:37    ttyS0
manager        5      05/23/14 16:31:44    192.168.1.200
```

Related commands

- [aaa local authentication attempts lockout-time](#)
- [aaa local authentication attempts max-fail](#)
- [clear aaa local user lockout](#)

show aaa server group

Overview Use this command to list AAA users and any method lists applied to them.

Syntax show aaa server group

Mode Privileged Exec

Example To show the AAA configuration on a device, use the command:

```
awplus# show aaa server group
```

Output Figure 42-2: Example output from **show aaa server group**

```
awplus#show aaa server group
```

User	List Name	Method	Acct-Event
login	auth default	-	local -
cmd-1	auth -	-	-
cmd-7	auth -	-	-
cmd-15	auth -	-	-
login	acct -	-	-
dot1x	auth default	radius	group -
dot1x	acct vlan30_acct	rad_group_4	group start-stop
auth-mac	auth default	radius	group -
auth-mac	acct vlan10_acct	rad_group_vlan10	group start-stop
auth-web	auth default	radius	group -
auth-web	acct default	rad_group_3	group start-stop
openvpn	auth -	-	-
isakmp	auth default	radius	group -

Related commands [aaa accounting auth-mac](#)

[aaa accounting auth-web](#)

[aaa accounting dot1x](#)

[aaa accounting auth-mac](#)

[aaa authentication auth-web](#)

[aaa authentication dot1x](#)

show debugging aaa

Overview Use this command to see what debugging is turned on for AAA (Authentication, Authorization, Accounting).

Syntax `show debugging aaa`

Mode User Exec and Privileged Exec

Example To display the current debugging status of AAA, use the command:

```
awplus# show debug aaa
```

Output Figure 42-3: Example output from the **show debug aaa** command

```
AAA debugging status:  
Authentication debugging is on  
Accounting debugging is off
```

show radius server group

Overview Use this command to show the RADIUS server group configuration.

Syntax show radius server group [*<group-name>*]

Parameter	Description
<i><group-name></i>	RADIUS server group name.

Default Command name is set to something by default.

Mode Privileged Exec

Usage Use this command with the *<group-name>* parameter to display information for a specific RADIUS server group, or without the parameter to display information for all RADIUS server groups.

Example To display information for all RADIUS server groups, use the command:

```
awplus# show radius server group
```

To display a information for a RADIUS server group named 'rad_group_list1', use the command:

```
awplus# show radius server group rad_group_list1
```

Output Figure 42-4: Example output from **show radius server group**

```
awplus#show radius server group
RADIUS Group Configuration
  Group Name : radius?
  Server Host/   Auth  Acct  Auth  Acct
  IP Address     Port  Port  Status Status
  -----
  192.168.1.101  1812  1813  Active Active
  192.168.1.102  1812  1813  Active Active

  Group Name : rad_group_list1
  Server Host/   Auth  Acct  Auth  Acct
  IP Address     Port  Port  Status Status
  -----
  192.168.1.101  1812  1813  Active Active

  Group Name : rad_group_list2
  Server Host/   Auth  Acct  Auth  Acct
  IP Address     Port  Port  Status Status
  -----
  192.168.1.102  1812  1813  Active Active
```

Figure 42-5: Example output from **show radius server group rad_group_list1**

```
awplus#show radius server group rad_group_list1
RADIUS Group Configuration
  Group Name : rad_group_list1
  Server Host/      Auth  Acct  Auth  Acct
  IP Address        Port  Port  Status Status
  -----
  192.168.1.101    1812 1813  Active Active
```

Related commands [aaa group server](#)

undebbug aaa

Overview This command applies the functionality of the **no debug aaa** command.

43

Lightweight Directory Access Protocol (LDAP) Commands

Introduction

Overview This chapter provides an alphabetical reference of commands used to configure Lightweight Directory Access Protocol (LDAP).

LDAP is an authentication protocol that facilitates user access to various IT resources e.g. applications, servers, networking equipment, and file servers.

It can be used to connect to internal networks over OpenVPN. Although both LDAP and RADIUS are interchangeable on AlliedWare Plus devices as an authentication protocol, LDAP is added because of its ability to interact with directory services such as Microsoft's Active Directory (AD).

For more information, see the [LDAP Feature Overview and Configuration Guide](#).

- Command List**
- [“authentication \(ldap-server\)”](#) on page 2290
 - [“base-dn”](#) on page 2292
 - [“bind authenticate root-dn”](#) on page 2293
 - [“deadtime \(ldap-server\)”](#) on page 2294
 - [“debug ldap client”](#) on page 2295
 - [“group-attribute”](#) on page 2297
 - [“group-dn”](#) on page 2298
 - [“host \(ldap-server\)”](#) on page 2299
 - [“ldap-server”](#) on page 2301
 - [“login-attribute”](#) on page 2303
 - [“port \(ldap-server\)”](#) on page 2305
 - [“retransmit \(ldap-server\)”](#) on page 2306
 - [“search-filter”](#) on page 2307
 - [“secure cipher \(ldap-server\)”](#) on page 2309

- [“secure mode \(ldap-server\)”](#) on page 2311
- [“secure trustpoint \(ldap-server\)”](#) on page 2313
- [“server \(ldap-group\)”](#) on page 2314
- [“show ldap server group”](#) on page 2315
- [“timeout \(ldap-server\)”](#) on page 2317

authentication (ldap-server)

Overview Use this command to set the authentication method used to authenticate users against the Lightweight Directory Access Protocol (LDAP) server.

Use the **no** variant of this command to reset the authentication method to **search**.

Syntax authentication {search|bind-only}
no authentication

Parameter	Description
search	The search method initially binds to the LDAP server, then searches for the user, then binds to the user using the DN found with the search. The initial bind is either anonymous, or using the user specified with the bind authenticate root-dn command.
bind-only	The bind-only method attempts to bind to the LDAP server using a predicted DN based on the username, the user attribute (set with the login-attribute command) and the base DN (set with the base-dn command). The format of this user DN is as follows: '<username>=<login-attribute>,<base-dn>'

Default Search

Mode LDAP Server Configuration

Example To set the authentication method to bind-only for the LDAP server called 'Server1', use the commands:

```
awplus# configure terminal
awplus(config)# ldap-server Server1
awplus(config-ldap-server)# authentication bind-only
```

To reset the authentication method to the default (search) for 'Server1', use the commands:

```
awplus# configure terminal
awplus(config)# ldap-server Server1
awplus(config-ldap-server)# no authentication
```

Related commands

- [base-dn](#)
- [bind authenticate root-dn](#)
- [ldap-server](#)
- [login-attribute](#)
- [search-filter](#)

Command changes Version 5.5.2-1.1: command added

base-dn

- Overview** Use this command to set the base DN (Distinguished Name) of the LDAP server.
- When using 'search' authentication, the base DN is the LDAP server's starting point to search for the user within the directory.
- If 'bind-only' authentication is enabled, then the base DN is the suffix of the DN that is used to bind to the user.
- Use the **no** variant of this command to remove the configured base DN.

Syntax base-dn <base-dn>
no base-dn

Parameter	Description
<base-dn>	The base DN of the LDAP server.

Default Not set

Mode LDAP Server Configuration

Example To set the base DN for the LDAP server called 'Server1' to 'dc=example, dc=com', use the commands:

```
awplus# configure terminal
awplus(config)# ldap-server Server1
awplus(config-ldap-server)# base-dn dc=example,dc=com
```

To clear the base DN for Server1, use the commands:

```
awplus# configure terminal
awplus(config)# ldap-server Server1
awplus(config-ldap-server)# no base-dn
```

Related commands

- [authentication \(ldap-server\)](#)
- [bind authenticate root-dn](#)
- [group-attribute](#)
- [group-dn](#)
- [ldap-server](#)
- [login-attribute](#)
- [search-filter](#)

Command changes Version 5.5.2-1.1: command added

bind authenticate root-dn

Overview Use this command to set the authenticated user to bind to when searching for a user on an LDAP server. Do not set this option if you wish to use anonymous binding with the 'search' method.

This option is ignored with the 'bind-only' authentication method.

Use the **no** variant of this command to unset the authenticated user.

Syntax `bind authenticate root-dn <user-dn> password <password>`
`no bind authenticate root-dn`

Parameter	Description
<code><user-dn></code>	The DN of the authenticated user to bind to.
<code><password></code>	The password of the authenticated user.

Default Not set

Mode LDAP Server Configuration

Example To set the authenticated user to 'cn=admin,dc=example,dc=com' with the password '12345678' for the LDAP server called 'Server1', use the commands:

```
awplus# configure terminal
awplus(config)# ldap-server Server1
awplus(config-ldap-server)# bind authenticate root-dn
cn=admin,dc=example,dc=com password 12345678
```

Related commands [authentication \(ldap-server\)](#)

[base-dn](#)

[group-attribute](#)

[ldap-server](#)

[login-attribute](#)

[search-filter](#)

Command changes Version 5.5.2-1.1: command added

deadtime (ldap-server)

Overview Use this command to configure the deadtime for an LDAP server. The configured deadtime is how long in seconds before an unresponsive LDAP server is considered dead.

Use the **no** variant of this command to remove the deadtime configured on an LDAP server. When you remove the deadtime, the server will never be considered dead.

Syntax `deadtime <0-1440>`
`no deadtime`

Parameter	Description
<code><0-1440></code>	The number of seconds that the server can be unresponsive for before it is considered dead.

Default 0 seconds (the LDAP server is never considered dead)

Mode LDAP Server Configuration

Example To set the deadtime to 20 seconds for the LDAP server called 'Server1', use the commands:

```
awplus# configure terminal
awplus(config)# ldap-server Server1
awplus(config-ldap-server)# deadtime 20
```

To reset the deadtime to the default for 'Server1', use the commands:

```
awplus# configure terminal
awplus(config)# ldap-server Server1
awplus(config-ldap-server)# no deadtime
```

Related commands [host \(ldap-server\)](#)
[ldap-server](#)
[port \(ldap-server\)](#)
[retransmit \(ldap-server\)](#)
[show ldap server group](#)
[timeout \(ldap-server\)](#)

Command changes Version 5.5.2-1.1: command added

debug ldap client

Overview Use this command to enable LDAP debugging.

Use the **no** variant of this command to disable all LDAP debugging.

Syntax

```
debug ldap client all  
debug ldap client {[args] [ber] [config] [conns] [filter]  
[packets] [parse] [shell] [stats] [stats2] [sync] [trace]}  
no debug ldap client
```

Parameter	Enable or disable debugging for ...
all	All LDAP debugging options
args	Heavy trace debugging (args, arguments)
ber	Print out packets sent and received (ber, Bit Error Rate)
config	Configuration processing
conns	Connection management
filter	Search filter processing
packets	Debug packet handling
parse	Parsing processing
shell	Print communication with shell backends
stats	Stats from connections, operations and results
stats2	Stats from log entries sent
sync	Syncrepl consumer processing (LDAP Sync replication)
trace	Trace function calls

Default By default, all LDAP debugging is disabled.

Mode Global Configuration

Example To turn on all LDAP debugging, use the command:

```
awplus# debug ldap client all
```

To turn on filter and packet LDAP debugging, use the command:

```
awplus# debug ldap client filter packets
```

To disable all LDAP debugging, use the command:

```
awplus# no debug ldap client
```

Related commands [aaa authentication login](#)
[aaa authentication openvpn](#)

aaa group server

ldap-server

Command changes Version 5.5.2-1.1: command added

group-attribute

Overview Use this command to configure the name of the attribute that group members are stored in.

It is only necessary to set this option if [group-dn](#) is used and you don't want to use the default attribute, which is 'uniquemember'.

Use the **no** variant of this command to revert to the default group attribute.

Syntax `group-attribute <attribute>`
`no group-attribute`

Parameter	Description
<code><attribute></code>	The attribute that group members are stored in.

Default The default group attribute is 'uniquemember'.

Mode LDAP Server Configuration

Example To set the group attribute for the LDAP server called 'Server1' to 'member', use the commands:

```
awplus# configure terminal
awplus(config)# ldap-server Server1
awplus(config-ldap-server)# group-attribute member
```

To reset the group attribute to default for 'Server1', use the commands:

```
awplus# configure terminal
awplus(config)# ldap-server Server1
awplus(config-ldap-server)# no group-attribute
```

Related commands [base-dn](#)
[bind authenticate root-dn](#)
[group-dn](#)
[ldap-server](#)
[login-attribute](#)
[search-filter](#)

Command changes Version 5.5.2-1.1: command added

group-dn

Overview Use this command to configure the group DN (Distinguished Name) of the group that users should be a member of.

By default the device will determine this by checking the 'uniquemember' attribute of the group to see if it contains the user's DN string. This can be changed with the [group-attribute](#) command.

Use the **no** variant of this command to remove the configured group DN.

Syntax `group-dn <group-dn>`
`no group-dn`

Parameter	Description
<code><group-dn></code>	The DN of the group that users should be a member of.

Default Not set

Mode LDAP Server Configuration

Example To set the group DN for the LDAP server called 'Server1' to 'cn=Users,dc=example,dc=com', use the commands:

```
awplus# configure terminal
awplus(config)# ldap-server Server1
awplus(config-ldap-server)# group-dn cn=Users,dc=example,
dc=com
```

To clear the group DN for 'Server1', use the commands:

```
awplus# configure terminal
awplus(config)# ldap-server Server1
awplus(config-ldap-server)# no group-dn
```

Related commands [base-dn](#)
[bind authenticate root-dn](#)
[group-attribute](#)
[ldap-server](#)
[login-attribute](#)
[search-filter](#)

Command changes Version 5.5.2-1.1: command added

host (ldap-server)

Overview Use this command to configure the address of the remote LDAP server you want to connect to.

Use the **no** variant of this command to remove the remote LDAP server.

Syntax `host {<host-name>|<ip-address>|<ipv6-address>}`
`no host`

Parameter	Description
<code><hostname></code>	The hostname of the LDAP server.
<code><ip-address></code>	The IPv4 address of the LDAP server. Uses the format A.B.C.D.
<code><ipv6-address></code>	The IPv6 address of the LDAP server. Uses the format x:x::x:x.

Default Not set

Mode LDAP Server Configuration

Example To set the host for the LDAP server called 'Server1' to the IP address 10.0.0.1, use the commands:

```
awplus# configure terminal
awplus(config)# ldap-server Server1
awplus(config-ldap-server)# host 10.0.0.1
```

To set the host for Server1 to the IPv6 address 2001:0db8::a2, use the commands:

```
awplus# configure terminal
awplus(config)# ldap-server Server1
awplus(config-ldap-server)# host 2001:db8::a2
```

To set the host for Server1 to the hostname www.ldapserver.com, use the commands:

```
awplus# configure terminal
awplus(config)# ldap-server Server1
awplus(config-ldap-server)# host www.ldapserver.com
```

To unset the host for Server1, use the commands:

```
awplus# configure terminal
awplus(config)# ldap-server Server1
awplus(config-ldap-server)# no host
```

Related commands [ldap-server](#)
[port \(ldap-server\)](#)

retransmit (ldap-server)
secure mode (ldap-server)
secure cipher (ldap-server)
show ldap server group
secure trustpoint (ldap-server)
timeout (ldap-server)

Command changes Version 5.5.2-1.1: command added

ldap-server

Overview Use this command to configure an LDAP server and enter LDAP server configuration mode.

Use the **no** variant of this command to remove the specified server.

Syntax ldap-server <server-name>
no ldap-server <server-name>

Parameter	Description
<server-name>	The name of the LDAP server.

Default Not set

Mode Global Configuration

Example To create and configure an LDAP server called 'Server1', use the commands:

```
awplus# configure terminal
awplus(config)# ldap-server Server1
awplus(config-ldap-server)#
```

To configure the LDAP server called 'Server1', use the commands:

```
awplus# configure terminal
awplus(config)# ldap-server Server1
awplus(config-ldap-server)#
```

To remove an LDAP server called 'Server1', use the commands:

```
awplus# configure terminal
awplus(config)# no ldap-server Server1
```

Related commands

- [authentication \(ldap-server\)](#)
- [host \(ldap-server\)](#)
- [port \(ldap-server\)](#)
- [retransmit \(ldap-server\)](#)
- [secure cipher \(ldap-server\)](#)
- [secure mode \(ldap-server\)](#)
- [secure trustpoint \(ldap-server\)](#)
- [show ldap server group](#)
- [timeout \(ldap-server\)](#)

Command changes Version 5.5.2-1.1: command added

login-attribute

Overview Use this command to set the name of the attribute user names are stored in. The device will search this attribute for the user's DN (Distinguished Name).

It is only necessary to set this option if you don't want to use the default attribute, which is 'uid'.

If the authentication method is 'bind-only', then this attribute is used as the first component of the user DN, with the base DN added to complete the user DN.

Use the **no** variant of this command to reset the login attribute to the default of 'uid'.

Syntax login-attribute <attribute>
no login-attribute

Parameter	Description
<attribute>	The LDAP attribute to use for the username of connecting users.

Default uid

Mode LDAP Server Configuration

Example To set the login attribute for the LDAP server called 'Server1' to 'sAMAccountName', use the commands:

```
awplus# configure terminal
awplus(config)# ldap-server Server1
awplus(config-ldap-server)# login-attribute sAMAccountName
```

To reset the login attribute for 'Server1' to the default, use the commands:

```
awplus# configure terminal
awplus(config)# ldap-server Server1
awplus(config-ldap-server)# no login-attribute
```

Related command [authentication \(ldap-server\)](#)
[base-dn](#)
[bind authenticate root-dn](#)
[group-attribute](#)
[group-dn](#)
[ldap-server](#)
[search-filter](#)

Command changes Version 5.5.2-1.1: command added

port (ldap-server)

Overview Use this command to configure the port you are using to connect to the remote LDAP server.

Note that if secure ciphers are enabled, then the secure port is used instead. Secure ciphers are configured with the [secure mode \(ldap-server\)](#) command.

Use the **no** variant of this command to reset the port number to the default (389).

Syntax port <1-65535>
no port

Parameter	Description
<1-65535>	Port number from 1 through 65535.

Default 389

Mode LDAP Server Configuration

Example To set the port for the LDAP server called 'Server1' to 1579, use the commands:

```
awplus# configure terminal
awplus(config)# ldap-server Server1
awplus(config-ldap-server)# port 1579
```

To reset the port for 'Server1' to the default of 389, use the commands:

```
awplus# configure terminal
awplus(config)# ldap-server Server1
awplus(config-ldap-server)# no port
```

Related commands

- [deadtime \(ldap-server\)](#)
- [host \(ldap-server\)](#)
- [ldap-server](#)
- [retransmit \(ldap-server\)](#)
- [secure cipher \(ldap-server\)](#)
- [secure mode \(ldap-server\)](#)
- [secure trustpoint \(ldap-server\)](#)
- [show ldap server group](#)
- [timeout \(ldap-server\)](#)

Command changes Version 5.5.2-1.1: command added

retransmit (ldap-server)

Overview Use this command to configure the number of times a device will attempt to reconnect to the LDAP server before aborting.

Use the **no** variant of this command to reset the reconnect attempts to the default value of 3.

Syntax retransmit <0-100>
no retransmit

Parameter	Description
<0-100>	The number of times the device will attempt to reconnect to the LDAP server.

Default 3 times

Mode LDAP Server Configuration

Example To set the number of reconnect attempts for the LDAP server called 'Server1' to 5 attempts, use the commands:

```
awplus# configure terminal
awplus(config)# ldap-server Server1
awplus(config-ldap-server)# retransmit 5
```

To reset the number of reconnect attempts for 'Server1' to 3 attempts, use the commands:

```
awplus# configure terminal
awplus(config)# ldap-server Server1
awplus(config-ldap-server)# no retransmit
```

Related commands [deadtime \(ldap-server\)](#)
[host \(ldap-server\)](#)
[ldap-server](#)
[port \(ldap-server\)](#)
[timeout \(ldap-server\)](#)

Command changes Version 5.5.2-1.1: command added

search-filter

Overview Use this command to add a filter to use when searching for a user on the LDAP server.

The filter should be a form similar to 'attribute=value' or '&(attribute1=value1)(attribute2=value2)

Use the **no** variant of this command to remove the search filter.

Syntax search-filter <filter>
no search-filter

Parameter	Description
<filter>	The filter to use when searching for a user.

Default Not set

Mode LDAP Server Configuration

Usage notes If the 'bind-only' authentication method is used, then this value is unused.
For the search authentication method, a search operation is used to search the LDAP server. The client specifies the starting point (base DN) of the search, the search scope (either the object, its children, or the subtree rooted at the object), and a search filter.

Example To set a search filter on the LDAP server called 'Server1' to 'building=block1', use the commands:

```
awplus# configure terminal
awplus(config)# ldap-server Server1
awplus(config-ldap-server)# search-filter building=block1
```

To unset the search filter of 'Server1', use the commands:

```
awplus# configure terminal
awplus(config)# ldap-server Server1
awplus(config-ldap-server)# no search-filter
```

Related commands [authentication \(ldap-server\)](#)
[base-dn](#)
[bind authenticate root-dn](#)
[group-attribute](#)
[group-dn](#)
[ldap-server](#)

login-attribute

Command changes Version 5.5.2-1.1: command added

secure cipher (ldap-server)

Overview Use this command to configure the OpenSSL ciphers used in LDAP secure mode. You can choose groups of ciphers from a number of Mozilla TLS configs, or specify multiple individual ciphers in OpenSSL format.

Use the **no** variant of this command to remove the configured ciphers on a server.

Syntax `secure cipher {old|intermediate|modern}`
`secure cipher <cipher-list>`
`no secure cipher`

Parameter	Description
old	Ciphers in Mozilla's old TLS config. Alongside the modern and intermediate ciphers, this includes the following ciphers: DHE-RSA-CHACHA20-POLY1305,ECDHE-ECDSA-AES128SHA256, ECDHE-RSA-AES128-SHA256,ECDHE-ECDSA-AES128-SHA, ECDHE-RSA-AES128-SHA,ECDHE-ECDSA-AES256-SHA384, ECDHE-RSA-AES256-SHA384, ECDHE-ECDSA-AES256-SHA, ECDHE-RSA-AES256-SHA,DHE-RSA-AES128-SHA256, DHE-RSA-AES256-SHA256, AES128-GCM-SHA256, AES256-GCM-SHA384,AES128-SHA256, AES256-SHA256, AES128-SHA, AES256-SHA, DES-CBC3-SHA
intermediate	Ciphers in Mozilla's intermediate TLS config. Alongside the modern ciphers, this includes the following ciphers: ECDHE-ECDSA-AES128-GCM-SHA256,ECDHE-RSA-AES128-CM-SHA256, ECDHE-ECDSA-AES256-GCM-SHA384,ECDHE-RSA-AES256-CM-SHA384, ECDHE-ECDSA-CHACHA20-POLY1305,ECDHE-RSA-CHACHA20-POLY1305, DHE-RSA-AES128-GCM-SHA256,DHE-RSA-AES256-GCM-SHA384
modern	Ciphers in Mozilla's modern TLS config. Includes the following ciphers: TLS_AES_128_GCM_SHA256,TLS_AES_256_GCM_SHA384, TLS_CHACHA20_POLY1305_SHA256
<cipher-list>	The name (or names) of a cipher in OpenSSL format. This is a space separated list of cipher names, for example: DHE-DSS-AES256-GCM-SHA384 TLS_AES_256_GCM_SHA384

Default Not set

Mode LDAP Server Configuration

Example To use the Intermediate Mozilla cipher suite on the LDAP server called Server1, use the commands:

```
awplus# configure terminal
awplus(config)# ldap-server Server1
awplus(config-ldap-server)# secure cipher intermediate
```

To remove the configured ciphers on 'Server1', use the commands:

```
awplus# configure terminal
awplus(config)# ldap-server Server1
awplus(config-ldap-server)# no secure cipher
```

To use the ciphers DHE-DSS-AES256-GCM-SHA384 and TLS_AES_256_GCM_SHA384 on 'Server1', use the commands:

```
awplus# configure terminal
awplus(config)# ldap-server Server1
awplus(config-ldap-server)# secure cipher
DHE-DSS-AES256-GCM-SHA384 TLS_AES_256_GCM_SHA384
```

**Related
commands**

[host \(ldap-server\)](#)
[ldap-server](#)
[port \(ldap-server\)](#)
[secure mode \(ldap-server\)](#)
[secure trustpoint \(ldap-server\)](#)

**Command
changes**

Version 5.5.2-1.1: command added

secure mode (ldap-server)

Overview Use this command to configure the LDAP server to use secure mode. Secure mode encrypts communications with the LDAP server using TLS (Transport Layer Security). If you don't specify a port number, the default port (636) is used.

For secure mode, you should also set the CA certificate using the [secure trustpoint \(ldap-server\)](#) command.

Use **no secure mode** to disable secure mode for communicating with this LDAP server.

Use **no secure mode secure-port** to reset the secure mode port to the default.

Syntax secure mode [secure-port <port>]
no secure mode
no secure mode secure-port

Parameter	Description
<port>	The secure port for communicating with the LDAP server

Default Secure mode is disabled, and the default port is 636

Mode LDAP Server Configuration

Example To enable secure mode for communicating with the LDAP server called 'Server1', with the default port, use the commands:

```
awplus# configure terminal
awplus(config)# ldap-server Server1
awplus(config-ldap-server)# secure mode
```

To disable secure mode for communicating with 'Server1', use the commands:

```
awplus# configure terminal
awplus(config)# ldap-server Server1
awplus(config-ldap-server)# no secure mode
```

To enable secure mode with the port 1234 for communicating with 'Server1', use the commands:

```
awplus# configure terminal
awplus(config)# ldap-server Server1
awplus(config-ldap-server)# secure mode secure-port 1234
```

To reset the secure mode port to the default on 'Server1', use the commands:

```
awplus# configure terminal
awplus(config)# ldap-server Server1
awplus(config-ldap-server)# no secure mode secure-port
```

**Related
commands**

[host \(ldap-server\)](#)
[ldap-server](#)
[port \(ldap-server\)](#)
[secure cipher \(ldap-server\)](#)
[secure trustpoint \(ldap-server\)](#)

**Command
changes**

Version 5.5.2-1.1: command added

secure trustpoint (ldap-server)

Overview Use this command to link a preconfigured trustpoint to the LDAP server configuration. The trustpoint must be the LDAP server certificate and is required to successfully connect to the LDAP server when secure mode is enabled.

Use the **no** variant of this command to remove a trustpoint from an LDAP server.

Syntax `secure trustpoint <trustpoint>`
`no secure trustpoint`

Parameter	Description
<code><trustpoint></code>	The name of the trustpoint used for LDAP secure mode

Default Not set

Mode LDAP Server Configuration

Example To set the trustpoint to Trustpoint1 for the LDAP server called 'Server1', use the commands:

```
awplus# configure terminal
awplus(config)# ldap server Server1
awplus(config-ldap-server)# secure trustpoint Trustpoint1
```

To remove the trustpoint from 'Server1', use the commands:

```
awplus# configure terminal
awplus(config)# ldap server Server1
awplus(config-ldap-server)# no secure trustpoint
```

Related commands [host \(ldap-server\)](#)
[ldap-server](#)
[port \(ldap-server\)](#)
[secure cipher \(ldap-server\)](#)
[secure mode \(ldap-server\)](#)

Command changes Version 5.5.2-1.1: command added

server (ldap-group)

Overview Use this command to add an LDAP server to an LDAP server group. The server is identified by the name of the server, which is created using the [ldap-server](#) command. Use the **no** variant of this command to remove an LDAP server from an LDAP server group.

Syntax `server <server-name>`
`no server <server-name>`

Parameter	Description
<code><server-name></code>	The name of the LDAP server group, specified when creating the LDAP server.

Default By default, LDAP servers are only added to the default 'ldap' server group.

Mode LDAP Server Group Configuration

Usage notes The server is appended to the server list of the group, and the order of configuration determines the precedence of servers.

Example To add the LDAP server called 'Server1' to the LDAP server group called 'Group1', use the commands:

```
awplus# configure terminal
awplus(config)# aaa group server ldap Group1
awplus(config-ldap-group)# server Server1
```

To remove 'Server1' from 'Group1', use the commands:

```
awplus# configure terminal
awplus(config)# aaa group server ldap Group1
awplus(config-ldap-group)# no server Server1
```

Related commands [aaa authentication login](#)
[aaa authentication openvpn](#)
[aaa group server](#)
[ldap-server](#)
[show ldap server group](#)

Command changes Version 5.5.2-1.1: command added

show ldap server group

Overview Use this command to display information about LDAP server groups, their servers and the status of those servers.

Syntax `show ldap server group [<group-name>]`

Parameter	Description
<code><group-name></code>	The name of the LDAP server group.

Mode Global Configuration

Usage notes If you specify a single group name, you will only see information relating to that specific server group. Otherwise, all LDAP server groups are shown, including the 'ldap' group that contains every LDAP server.

Example To show all server groups, use the command:

```
awplus# show ldap server group
```

To show the default LDAP group that includes all the LDAP servers, use the command:

```
awplus# show ldap server group ldap
```

To show a server group named 'CustomGroup1', use the command:

```
awplus# show ldap server group CustomGroup1
```

Output Figure 43-1: Example output from **show ldap server group**

```
LDAP Group Configuration
Group Name : ldap
LDAP server name  Server Host/IP Address      Port  Status
-----
server_one       10.1.1.1                N/A   Alive
server_two       10.2.1.1                N/A   Dead (1 hour)

Group Name : CustomGroup1
LDAP server name  Server Host/IP Address      Port  Status
-----
server_one       10.1.1.1                N/A   Alive

Group Name : CustomGroup2
LDAP server name  Server Host/IP Address      Port  Status
-----
No LDAP servers currently defined
```

Related commands

- [aaa authentication login](#)
- [aaa authentication openvpn](#)
- [aaa group server](#)

deadtime (ldap-server)

ldap-server

port (ldap-server)

server (ldap-group)

Command changes Version 5.5.2-1.1: command added

timeout (ldap-server)

Overview Use this command to set the time to wait for a connection before reattempting to connect to the LDAP server.

Use the **no** variant of this command to reset the timeout back to the default value.

Syntax `timeout <1-1000>`
`no timeout`

Parameter	Description
<code><1-1000></code>	The number of seconds to wait for a connection before reattempting to connect to the LDAP server.

Default 5 seconds

Mode LDAP Server Configuration

Example To set the server timeout for the LDAP server called 'Server1' to 10 seconds, use the commands:

```
awplus# configure terminal
awplus(config)# ldap-server Server1
awplus(config-ldap-server)# timeout 10
```

To set the server timeout for 'Server1' to the default, use the commands:

```
awplus# configure terminal
awplus(config)# ldap-server Server1
awplus(config-ldap-server)# no timeout
```

Related commands [deadtime \(ldap-server\)](#)
[host \(ldap-server\)](#)
[ldap-server](#)
[port \(ldap-server\)](#)
[retransmit \(ldap-server\)](#)

Command changes Version 5.5.2-1.1: command added

44

RADIUS Commands

Introduction

Overview This chapter provides an alphabetical reference for commands used to configure the device to use RADIUS servers. For more information, see the [RADIUS Feature Overview and Configuration Guide](#).

- Command List**
- “clear radius dynamic-authorization counters” on page 2319
 - “deadtime (RADIUS server group)” on page 2320
 - “debug radius” on page 2321
 - “ip radius source-interface” on page 2322
 - “radius dynamic-authorization-client” on page 2323
 - “radius-server deadtime” on page 2324
 - “radius-server host” on page 2325
 - “radius-server key” on page 2329
 - “radius-server retransmit” on page 2330
 - “radius-server timeout” on page 2332
 - “server (RADIUS server group)” on page 2334
 - “show debugging radius” on page 2336
 - “show radius” on page 2337
 - “show radius dynamic-authorization counters” on page 2340
 - “undebug radius” on page 2342

clear radius dynamic-authorization counters

Overview Use this command to set the Dynamic Authorization message counters to zero.

Syntax `clear radius dynamic-authorization counters`

Mode Privileged Exec

Example To set the Dynamic Authorization message counters to zero, use the command:

```
awplus# clear radius dynamic-authorization counters
```

Related commands [radius dynamic-authorization-client](#)
[show radius dynamic-authorization counters](#)

Command changes Version 5.5.1-1.1: command added

deadtime (RADIUS server group)

Overview Use this command to configure the **deadtime** parameter for the RADIUS server group. This command overrides the global dead-time configured by the [radius-server deadtime](#) command. The configured deadtime is the time period in minutes to skip a RADIUS server for authentication or accounting requests if the server is 'dead'. Note that a RADIUS server is considered 'dead' if there is no response from the server within a defined time period.

Use the **no** variant of this command to reset the deadtime configured for the RADIUS server group. If the global deadtime for RADIUS server is configured the value will be used for the servers in the group. The global deadtime for the RADIUS server is set to 0 minutes by default.

Syntax `deadtime <0-1440>`
`no deadtime`

Parameter	Description
<code><0-1440></code>	Amount of time in minutes.

Default The deadtime is set to 0 minutes by default.

Mode RADIUS Server Group Configuration

Usage If the RADIUS server does not respond to a request packet, the packet is retransmitted the number of times configured for the **retransmit** parameter (after waiting for a **timeout** period to expire). The server is then marked 'dead', and the time is recorded. The **deadtime** parameter configures the amount of time to skip a dead server; if a server is dead, no request message is sent to the server for the **deadtime** period.

Examples To configure the deadtime for 5 minutes for the RADIUS server group 'GROUP1', use the commands:

```
awplus(config)# aaa group server radius GROUP1
awplus(config-sg)# server 192.168.1.1
awplus(config-sg)# deadtime 5
```

To remove the deadtime configured for the RADIUS server group 'GROUP1', use the commands:

```
awplus(config)# aaa group server radius GROUP1
awplus(config-sg)# no deadtime
```

Related commands [aaa group server](#)
[radius-server deadtime](#)

debug radius

Overview This command enables RADIUS debugging. If no option is specified, all debugging options are enabled.

Use the **no** variant of this command to disable RADIUS debugging. If no option is specified, all debugging options are disabled.

Syntax debug radius [packet|event|all]
no debug radius [packet|event|all]

Parameter	Description
packet	Debugging for RADIUS packets is enabled or disabled.
event	Debugging for RADIUS events is enabled or disabled.
all	Enable or disable all debugging options.

Default RADIUS debugging is disabled by default.

Mode Privileged Exec

Examples To enable debugging for RADIUS packets, use the command:

```
awplus# debug radius packet
```

To enable debugging for RADIUS events, use the command:

```
awplus# debug radius event
```

To disable debugging for RADIUS packets, use the command:

```
awplus# no debug radius packet
```

To disable debugging for RADIUS events, use the command:

```
awplus# no debug radius event
```

Related commands [show debugging radius](#)
[undebug radius](#)

ip radius source-interface

Overview This command configures the source IP address of every outgoing RADIUS packet to use a specific IP address or the IP address of a specific interface. If the specified interface is down or there is no IP address on the interface, then the source IP address of outgoing RADIUS packets depends on the interface the packets leave.

Use the **no** variant of this command to remove the source interface configuration. The source IP address in outgoing RADIUS packets will be the IP address of the interface from which the packets are sent.

Syntax `ip radius source-interface {<interface>|<ip-address>}`
`no ip radius source-interface`

Parameter	Description
<code><interface></code>	Interface name.
<code><ip-address></code>	IP address in the dotted decimal format A.B.C.D.

Default Source IP address of outgoing RADIUS packets depends on the interface the packets leave.

Mode Global Configuration

Examples To configure all outgoing RADIUS packets to use the IP address of the interface "vlan1" for the source IP address, use the following commands:

```
awplus# configure terminal
awplus(config)# ip radius source-interface vlan1
```

To configure the source IP address of all outgoing RADIUS packets to use 192.168.1.10, use the following commands:

```
awplus# configure terminal
awplus(config)# ip radius source-interface 192.168.1.10
```

To reset the source interface configuration for all outgoing RADIUS packets, use the following commands:

```
awplus# configure terminal
awplus(config)# no ip radius source-interface
```

Related commands [radius-server host](#)

radius dynamic-authorization-client

Overview Use this command to add a Dynamic Authorization Client (DAC). A Network Access Server (NAS) will only accept Dynamic Authorization (DA) messages from DACs that have been authorized using this command.

Use the **no** variant of this command to remove a DAC from the list of authorized clients.

Syntax `radius dynamic-authorization-client <ip-address> key <key-string>`
`no radius dynamic-authorization-client <ip-address>`

Parameter	Description
<code><ip-address></code>	IP address of the DAC, entered in the form A.B.C.D
<code>key</code>	Sets the shared-key of the client.

Mode Global Configuration

Usage notes The RADIUS protocol does not support unsolicited messages sent from the RADIUS server to the NAS. This means that the network access configuration a supplicant receives from a RADIUS server cannot be updated until the supplicant re-authenticates with the RADIUS server.

In some situations it is desirable to either update a supplicant's configuration, or even disconnect their session.

This command allows a Dynamic Authentication Client to send a message that will either update or terminate a supplicant's session.

Example To add a DAC with IP address 10.0.0.1, use the commands:

```
awplus# configure terminal
awplus(config)# radius dynamic-authorization-client 10.0.0.1
key secret-key
```

To remove the configuration for a DAC with IP address 10.0.0.1, use the commands:

```
awplus# configure terminal
awplus(config)# no radius dynamic-authorization-client 10.0.0.1
```

Related commands [clear radius dynamic-authorization counters](#)
[show radius dynamic-authorization counters](#)

Command changes Version 5.5.1-1.1: command added

radius-server deadtime

Overview Use this command to specify the global **deadtime** for all RADIUS servers. If a RADIUS server is considered dead, it is skipped for the specified deadtime. This command specifies for how many minutes a RADIUS server that is not responding to authentication requests is passed over by requests for RADIUS authentication.

Use the **no** variant of this command to reset the global deadtime to the default of 0 seconds, so that RADIUS servers are not skipped even if they are dead.

Syntax `radius-server deadtime <minutes>`
`no radius-server deadtime`

Parameter	Description
<code><minutes></code>	RADIUS server deadtime in minutes in the range 0 to 1440 (24 hours).

Default The default RADIUS deadtime configured on the system is 0 seconds.

Mode Global Configuration

Usage The RADIUS client considers a RADIUS server to be dead if it fails to respond to a request after it has been retransmitted as often as specified globally by the [radius-server retransmit](#) command or for the server by the [radius-server host](#) command. To improve RADIUS response times when some servers may be unavailable, set a **deadtime** to skip dead servers.

Examples To set the dead time of the RADIUS server to 60 minutes, use the following commands:

```
awplus# configure terminal
awplus(config)# radius-server deadtime 60
```

To disable the dead time of the RADIUS server, use the following commands:

```
awplus# configure terminal
awplus(config)# no radius-server deadtime
```

Related commands [deadtime \(RADIUS server group\)](#)
[radius-server host](#)
[radius-server retransmit](#)

radius-server host

Overview Use this command to specify a remote RADIUS server host for authentication or accounting, and to set server-specific parameters. The parameters specified with this command override the corresponding global parameters for RADIUS servers. This command specifies the IP address or host name of the remote RADIUS server host and assigns authentication and accounting destination UDP port numbers.

This command adds the RADIUS server address and sets parameters to the RADIUS server. The RADIUS server is added to the running configuration after you issue this command. If parameters are not set using this command then common system settings are applied.

Use the **no** variant of this command to remove the specified server host as a RADIUS authentication and/or accounting server and set the destination port to the default RADIUS server port number (1812).

Syntax

```
radius-server host {<host-name>|<ip-address>} [acct-port <0-65535>] [auth-port <0-65535>] [key <key-string>] [retransmit <0-100>] [timeout <1-1000>]
no radius-server host {<host-name>|<ip-address>} [acct-port <0-65535>] [auth-port <0-65535>]
```

Syntax (VRF-lite)

```
radius-server host {<host-name>|<ip-address>} [acct-port <0-65535>] [auth-port <0-65535>] [key <key-string>] [retransmit <0-100>] [timeout <1-1000>] [vrf <vrf-name>]
no radius-server host {<host-name>|<ip-address>} [acct-port <0-65535>] [auth-port <0-65535>] [vrf <vrf-name>]
```

Parameter	Description
<host-name>	Server host name. The DNS name of the RADIUS server host.
<ip-address>	The IP address of the RADIUS server host.
acct-port	Accounting port. Specifies the UDP destination port for RADIUS accounting requests. If 0 is specified, the server is not used for accounting. The default UDP port for accounting is 1813.
<0-65535>	UDP port number. (Accounting port number is set to (accounting port number is set to 1813 by default) Specifies the UDP destination port for RADIUS accounting requests. If 0 is specified, the host is not used for accounting.
auth-port	Authentication port. Specifies the UDP destination port for RADIUS authentication requests. If 0 is specified, the server is not used for authentication. The default UDP port for authentication is 1812.
<0-65535>	UDP port number (authentication port number is set to 1812 by default). Specifies the UDP destination port for RADIUS authentication requests. If 0 is specified, the host is not used for authentication.

Parameter	Description
timeout	Specifies the amount of time to wait for a response from the server. If this parameter is not specified the global value configured by the radius-server timeout command is used.
<1-1000>	Time in seconds to wait for a server reply (timeout is set to 5 seconds by default). The time interval (in seconds to wait for the RADIUS server to reply before retransmitting a request or considering the server dead. This setting overrides the global value set by the radius-server timeout command. If no timeout value is specified for this server, the global value is used.
retransmit	Specifies the number of retries before skip to the next server. If this parameter is not specified the global value configured by the radius-server retransmit command is used.
<0-100>	Maximum number of retries (maximum number of retries is set to 3 by default). The maximum number of times to resend a RADIUS request to the server, if it does not respond within the timeout interval, before considering it dead and skipping to the next RADIUS server. This setting overrides the global setting of the radius-server retransmit command. If no retransmit value is specified, the global value is used.
key	Set shared secret key with RADIUS servers.
<key-string>	Shared key string applied. Specifies the shared secret authentication or encryption key for all RADIUS communications between this device and the RADIUS server. This key must match the encryption used on the RADIUS daemon. All leading spaces are ignored, but spaces within and at the end of the string are used. If spaces are used in the string, do not enclose the string in quotation marks unless the quotation marks themselves are part of the key. This setting overrides the global setting of the radius-server key command. If no key value is specified, the global value is used.
vrf <vrf-name>	The name of a VRF instance. Use this to specify the VRF that the RADIUS server is accessible by. Servers are uniquely identified by their address and VRF, so multiple servers can have the same address or host-name as long as the VRF is different. The default is the global VRF.

Default The RADIUS client address is not configured (null) by default. No RADIUS server is configured.

Mode Global Configuration

Usage Multiple **radius-server host** commands can be used to specify multiple hosts. The software searches for hosts in the order they are specified. If no host-specific timeout, retransmit, or key values are specified, the global values apply to that host. If there are multiple RADIUS servers for this client, use this command multiple times—once to specify each server.

If you specify a host without specifying the auth port or the acct port, it will by default be configured for both authentication and accounting, using the default

UDP ports. To set a host to be a RADIUS server for authentication requests only, set the **acct-port** parameter to 0; to set the host to be a RADIUS server for accounting requests only, set the **auth-port** parameter to 0.

A RADIUS server is identified by IP address, authentication port and accounting port. A single host can be configured multiple times with different authentication or accounting ports. All the RADIUS servers configured with this command are included in the predefined RADIUS server group **radius**, which may be used by AAA authentication, authorization and accounting commands. The client transmits (and retransmits, according to the **retransmit** and **timeout** parameters) RADIUS authentication or accounting requests to the servers in the order you specify them, until it gets a response.

Examples To add the RADIUS server 10.0.0.20, use the following commands:

```
awplus# configure terminal
awplus(config)# radius-server host 10.0.0.20
```

To set the secret key to 'mySecret' on the RADIUS server 10.0.0.20, use the following commands:

```
awplus# configure terminal
awplus(config)# radius-server host 10.0.0.20 key mySecret
```

To delete the RADIUS server 10.0.0.20, use the following commands:

```
awplus# configure terminal
awplus(config)# no radius-server host 10.0.0.20
```

To configure rad1.company.com for authentication only, use the following commands:

```
awplus# configure terminal
awplus(config)# radius-server host rad1.company.com acct-port 0
```

To remove the RADIUS server rad1.company.com configured for authentication only, use the following commands:

```
awplus# configure terminal
awplus(config)# no radius-server host rad1.company.com
acct-port 0
```

To configure rad2.company.com for accounting only, use the following commands:

```
awplus# configure terminal
awplus(config)# radius-server host rad2.company.com auth-port 0
```

To configure 192.168.1.1 with authentication port 1000, accounting port 1001 and retransmit count 5, use the following commands:

```
awplus# configure terminal
awplus(config)# radius-server host 192.168.1.1 auth-port 1000
acct-port 1001 retransmit 5
```

Examples (VRF-lite) To add the RADIUS server 10.0.0.20 in the VRF named 'red', use the following commands:

```
awplus# configure terminal
awplus(config)# radius-server host 10.0.0.20 vrf red
```

To set the secret key to 'mySecret' on the RADIUS server 10.0.0.20 in the VRF named 'red', use the following commands:

```
awplus# configure terminal
awplus(config)# radius-server host 10.0.0.20 key mySecret vrf
red
```

Related commands

- [aaa group server](#)
- [radius-server key](#)
- [radius-server retransmit](#)
- [radius-server timeout](#)

Command changes

- Version 5.5.2-1.1: **vrf** parameter added for products that support VRF
- Version 5.4.9-2.1: **key-encrypted** parameter added

radius-server key

Overview This command sets a global secret key for RADIUS authentication on the device. The shared secret text string is used for RADIUS authentication between the device and a RADIUS server.

Note that if no secret key is explicitly specified for a RADIUS server, the global secret key will be used for the shared secret for the server.

Use the **no** variant of this command to reset the secret key to the default (null).

Syntax `radius-server key <key-string>`
`no radius-server key`

Parameter	Description
<code><key-string></code>	Shared secret among RADIUS server and 802.1X client.

Default The RADIUS server secret key on the system is not set by default (null).

Mode Global Configuration

Usage Use this command to set the global secret key shared between this client and its RADIUS servers. If no secret key is specified for a particular RADIUS server using the **radius-server host** command, this global key is used.

After enabling AAA authentication with the **aaa authentication login** command, set the authentication and encryption key using the **radius-server key** command so the key entered matches the key used on the RADIUS server.

Examples To set the global secret key to **allied** for RADIUS server, use the following commands:

```
awplus# configure terminal
awplus(config)# radius-server key allied
```

To set the global secret key to **secret** for RADIUS server, use the following commands:

```
awplus# configure terminal
awplus(config)# radius-server key secret
```

To delete the global secret key for RADIUS server, use the following commands:

```
awplus# configure terminal
awplus(config)# no radius-server key
```

Related commands [radius-server host](#)

radius-server retransmit

Overview This command sets the retransmit counter to use RADIUS authentication on the device. This command specifies how many times the device transmits each RADIUS request to the RADIUS server before giving up.

This command configures the **retransmit** parameter for RADIUS servers globally. If the **retransmit** parameter is not specified for a RADIUS server by the **radius-server host** command then the global configuration set by this command is used for the server instead.

Use the **no** variant of this command to reset the re-transmit counter to the default (3).

Syntax `radius-server retransmit <retries>`
`no radius-server retransmit`

Parameter	Description
<retries>	RADIUS server retries in the range <0-100>. The number of times a request is resent to a RADIUS server that does not respond, before the server is considered dead and the next server is tried. If no retransmit value is specified for a particular RADIUS server using the radius-server host command, this global value is used.

Default The default RADIUS retransmit count on the device is 3.

Mode Global Configuration

Examples To set the RADIUS **retransmit** count to 1, use the following commands:

```
awplus# configure terminal
awplus(config)# radius-server retransmit 1
```

To set the RADIUS **retransmit** count to the default (3), use the following commands:

```
awplus# configure terminal
awplus(config)# no radius-server retransmit
```

To configure the RADIUS **retransmit** count globally with 5, use the following commands:

```
awplus# configure terminal
awplus(config)# radius-server retransmit 5
```

To disable retransmission of requests to a RADIUS server, use the following commands:

```
awplus# configure terminal
awplus(config)# radius-server retransmit 0
```

**Related
commands** [radius-server deadtime](#)
[radius-server host](#)

radius-server timeout

Overview Use this command to specify the RADIUS global timeout value. This is how long the device waits for a reply to a RADIUS request before retransmitting the request, or considering the server to be dead. If no timeout is specified for the particular RADIUS server by the **radius-server host** command, it uses this global timeout value.

Note that this command configures the **timeout** parameter for RADIUS servers globally.

The **no** variant of this command resets the transmit timeout to the default (5 seconds).

Syntax `radius-server timeout <seconds>`
`no radius-server timeout`

Parameter	Description
<code><seconds></code>	RADIUS server timeout in seconds in the range 1 to 1000. The global time in seconds to wait for a RADIUS server to reply to a request before retransmitting the request, or considering the server to be dead (depending on the radius-server retransmit command).

Default The default RADIUS transmit timeout on the system is 5 seconds.

Mode Global Configuration

Examples To globally set the device to wait 20 seconds before retransmitting a RADIUS request to unresponsive RADIUS servers, use the following commands:

```
awplus# configure terminal
awplus(config)# radius-server timeout 20
```

To set the RADIUS **timeout** parameter to 1 second, use the following commands:

```
awplus# configure terminal
awplus(config)# radius-server timeout 1
```

To set the RADIUS **timeout** parameter to the default (5 seconds), use the following commands:

```
awplus# configure terminal
awplus(config)# no radius-server timeout
```

To configure the RADIUS server **timeout** period globally with 3 seconds, use the following commands:

```
awplus# configure terminal
awplus(config)# radius-server timeout 3
```

To reset the global **timeout** period for RADIUS servers to the default, use the following command:

```
awplus# configure terminal  
awplus(config)# no radius-server timeout
```

**Related
commands**

[radius-server deadtime](#)
[radius-server host](#)
[radius-server retransmit](#)

server (RADIUS server group)

Overview This command adds a RADIUS server to a server group in RADIUS Server Group Configuration mode. The RADIUS server should be configured by the [radius-server host](#) command.

The device adds each server to the end of the group's list of servers, so add the servers in order of priority. If you add a server and it is already in the list, it will be removed and then re-added to the end of the list.

The server is identified by IP address and authentication and accounting UDP port numbers. So a RADIUS server can have multiple entries in a group with different authentication and/or accounting UDP ports. The **auth-port** specifies the UDP destination port for authentication requests to the server. To disable authentication for the server, set **auth-port** to 0. If the authentication port is missing, the default port number is 1812. The **acct-port** specifies the UDP destination port for accounting requests to the server. To disable accounting for the server, set **acct-port** to 0. If the accounting port is missing, the default port number is 1813.

Use the **no** variant of this command to remove a RADIUS server from the server group.

Syntax

```
server {<hostname>|<ip-address>} [auth-port <0-65535>]  
[acct-port <0-65535>]  
  
no server {<hostname>|<ip-address>} [auth-port <0-65535>]  
[acct-port <0-65535>]
```

Parameter	Description
<hostname>	Server host name
<ip-address>	Server IP address The server is identified by IP address, authentication and accounting UDP port numbers. So a RADIUS server can have multiple entries in a group with different authentication and/or accounting UDP ports.
auth-port	Authentication port The auth-port specifies the UDP destination port for authentication requests to the server. To disable authentication for the server, set auth-port to 0. If the authentication port is missing, the default port number is 1812.
<0-65535>	UDP port number (default: 1812)
acct-port	Accounting port The acct-port specifies the UDP destination port for accounting requests to the server. To disable accounting for the server, set acct-port to 0. If the accounting port is missing, the default port number is 1813.
<0-65535>	UDP port number (default: 1813)

Default The default Authentication port number is 1812 and the default Accounting port number is 1813.

Mode RADIUS Server Group Configuration

Usage notes The RADIUS server to be added must be configured by the **radius-server host** command. In order to add or remove a server, the **auth-port** and **acct-port** parameters in this command must be the same as the corresponding parameters in the **radius-server host** command.

Examples To create a RADIUS server group 'RAD_AUTH1' for authentication, use the following commands:

```
awplus# configure terminal
awplus(config)# aaa group server radius RAD_AUTH1
awplus(config-sg)# server 192.168.1.1 acct-port 0
awplus(config-sg)# server 192.168.2.1 auth-port 1000 acct-port 0
```

To create a RADIUS server group 'RAD_ACCT1' for accounting, use the following commands:

```
awplus# configure terminal
awplus(config)# aaa group server radius RAD_ACCT1
awplus(config-sg)# server 192.168.2.1 auth-port 0 acct-port 1001
awplus(config-sg)# server 192.168.3.1 auth-port 0
```

To remove server 192.168.3.1 from the existing server group 'GROUP1', use the following commands:

```
awplus# configure terminal
awplus(config)# aaa group server radius GROUP1
awplus(config-sg)# no server 192.168.3.1
```

Related commands

- [aaa accounting login](#)
- [aaa authentication login](#)
- [aaa group server](#)
- [radius-server host](#)

show debugging radius

Overview This command displays the current debugging status for the RADIUS servers.

Syntax show debugging radius

Mode User Exec and Privileged Exec

Example To display the current debugging status of RADIUS servers, use the command:

```
awplus# show debugging radius
```

Output Figure 44-1: Example output from the **show debugging radius** command

```
RADIUS debugging status:
RADIUS event debugging is off
RADIUS packet debugging is off
```

show radius

Overview This command displays the current RADIUS server configuration and status.

Syntax show radius

Mode User Exec and Privileged Exec

Example To display the current status of RADIUS servers, use the command:

```
awplus# show radius
```

Output Figure 44-2: Example output from the **show radius** command showing RADIUS servers

```
RADIUS Global Configuration
Source Interface : not configured
Secret Key : secret
Timeout : 5 sec
Retransmit Count : 3
Deadtime : 20 min
Server Host : 192.168.1.10
Authentication Port : 1812
Accounting Port : 1813
Secret Key : secret
Timeout : 3 sec
Retransmit Count : 2
Server Host : 192.168.1.11
Authentication Port : 1812
Accounting Port : not configured

Server Name/   Auth   Acct   Auth   Acct
IP Address    Port   Port   Status Status
-----
192.168.1.10  1812   1813   Alive  Alive
192.168.1.11  1812   N/A    Alive  N/A
```

Example See the sample output below showing RADIUS client status and RADIUS configuration:

```
awplus# show radius
```

Output Figure 44-3: Example output from the **show radius** command showing RADIUS client status

```
RADIUS global interface name: awplus
  Secret key:
  Timeout: 5
  Retransmit count: 3
  Deadtime: 0

Server Address: 150.87.18.89
  Auth destination port: 1812
  Accounting port: 1813
  Secret key: swg
  Timeout: 5
  Retransmit count: 3
  Deadtime: 0
```

Output Parameter	Meaning
Source Interface	The interface name or IP address to be used for the source address of all outgoing RADIUS packets.
Secret Key	A shared secret key to a radius server.
Timeout	A time interval in seconds.
Retransmit Count	The number of retry count if a RADIUS server does not response.
Deadtime	A time interval in minutes to mark a RADIUS server as "dead".
Interim-Update	A time interval in minutes to send Interim-Update Accounting report.
Group Deadtime	The deadtime configured for RADIUS servers within a server group.
Server Host	The RADIUS server hostname or IP address.
Authentication Port	The destination UDP port for RADIUS authentication requests.
Accounting Port	The destination UDP port for RADIUS accounting requests.

Output Parameter	Meaning
Auth Status	The status of the authentication port. The status ("dead", "error", or "alive") of the RADIUS authentication server and, if dead, how long it has been dead for.
	Alive The server is alive.
	Error The server is not responding.
	Dead The server is detected as dead and it will not be used for deadtime period. The time displayed in the output shows the server is in dead status for that amount of time.
	Unknown The server is never used or the status is unknown.
Acct Status	The status of the accounting port. The status ("dead", "error", or "alive") of the RADIUS accounting server and, if dead, how long it has been dead for.

show radius dynamic-authorization counters

Overview Use this command to display the Dynamic Authorization message counters. It shows the count of sent and received messages, as well as a count of any error messages.

Syntax show radius dynamic-authorization counters

Mode Privileged Exec

Example To display the Dynamic Authorization message counters, use the following command:

```
awplus# show radius dynamic-authorization counters
```

Output Figure 44-4: Example output from **show radius dynamic-authorization counters**

```
awplus#show radius dynamic-authorization counters

RADIUS Dynamic Authorization packet counters
-----
Received:
  Disconnect request      : 9
  CoA request             : 6

Sent:
  Disconnect ACK         : 4
  CoA ACK                : 0
  Disconnect NAK        : 2
  CoA NAK                : 6

Dropped:
  Duplicate packet       : 2
  Expired packet         : 1

Error-cause:
  Unsupported attribute   : 0
  Missing attribute      : 0
  Invalid request        : 0
  NAS ID mismatch        : 0
  No session context found : 3

Errors:
  Unknown message type   : 0
  Unknown client         : 0
  Bad attribute          : 0
  Bad authenticator      : 0
  Malformed packet       : 0
```

Related commands [radius dynamic-authorization-client](#)
[clear radius dynamic-authorization counters](#)

Command changes Version 5.5.1-1.1: command added

undebbug radius

Overview This command applies the functionality of the **no debug radius** command.

45

Local RADIUS Server Commands

Introduction

Overview This chapter provides an alphabetical reference for commands used to configure the local RADIUS server on the device. For more information, see the [Local RADIUS Server Feature Overview and Configuration Guide](#).

- Command List**
- ["attribute \(radsrv-grp\)"](#) on page 2345
 - ["authentication"](#) on page 2347
 - ["client \(radsecproxy-srv\)"](#) on page 2348
 - ["client mutual-authentication"](#) on page 2350
 - ["client name-check"](#) on page 2351
 - ["client trustpoint"](#) on page 2352
 - ["clear radius local-server statistics"](#) on page 2353
 - ["copy fdb-radius-users \(to file\)"](#) on page 2354
 - ["copy local-radius-user-db \(from file\)"](#) on page 2356
 - ["copy local-radius-user-db \(to file\)"](#) on page 2357
 - ["crypto pki enroll local \(deleted\)"](#) on page 2358
 - ["crypto pki enroll local local-radius-all-users \(deleted\)"](#) on page 2359
 - ["crypto pki enroll local user \(deleted\)"](#) on page 2360
 - ["crypto pki export local pem \(deleted\)"](#) on page 2361
 - ["crypto pki export local pkcs12 \(deleted\)"](#) on page 2362
 - ["crypto pki trustpoint local \(deleted\)"](#) on page 2363
 - ["debug crypto pki \(deleted\)"](#) on page 2364
 - ["domain-style"](#) on page 2365
 - ["egress-vlan-id \(radsrv-grp\)"](#) on page 2366

- [“egress-vlan-name \(radsrv-grp\)”](#) on page 2367
- [“group \(radsrv\)”](#) on page 2368
- [“nas”](#) on page 2369
- [“help radius-attribute”](#) on page 2370
- [“radius-secure-proxy local-server”](#) on page 2372
- [“radius-server local”](#) on page 2373
- [“server auth-port”](#) on page 2374
- [“server enable”](#) on page 2375
- [“show radius local-server group”](#) on page 2376
- [“show radius local-server nas”](#) on page 2377
- [“show radius local-server statistics”](#) on page 2378
- [“show radius local-server user”](#) on page 2379
- [“user \(radsrv\)”](#) on page 2381
- [“vlan \(radsrv-grp\)”](#) on page 2383

attribute (radsrv-grp)

Overview Use this command to define a RADIUS attribute for the local RADIUS server user group.

For a complete list of defined RADIUS attributes and values, see the [Local RADIUS Server Feature Overview and Configuration Guide](#).

When used with the **value** parameter the **attribute** command configures RADIUS attributes to the user group. If the specified attribute is already defined then it is replaced with the new value.

Use the **no** variant of this command to delete an attribute from the local RADIUS server user group.

Syntax `attribute [repeated] {<attribute-name>|<attribute-id>} <value>`
`no attribute {<attribute-name>|<attribute-id>}`

Parameter	Description
repeated	This optional parameter allows you to set multiple instances of the same attribute name or attribute ID.
<attribute-name>	RADIUS attribute name for standard attributes or Vendor-Specific attributes (see the Local RADIUS Server Feature Overview and Configuration Guide for tables of attributes).
<attribute-id>	RADIUS attribute numeric identifier for standard attributes.
<value>	RADIUS attribute value.

Default By default, no attributes are configured.

Mode Local RADIUS Server User Group Configuration

Usage notes For the Standard attributes, the attribute may be specified using either the attribute name, or its numeric identifier. For example, the command:

```
awplus(config-radsrv-group)# attribute acct-terminate-cause 1
```

will produce the same results as the command:

```
awplus(config-radsrv-group)# attribute 49 1
```

In the same way, where the specific attribute has a pre-defined value, the parameter <value> may be substituted with the Value Name or with its numeric value, for example the command:

```
awplus(config-radsrv-group)# attribute acct-terminate-cause  
user-request
```

will produce the same results as the command:

```
awplus(config-radsrv-group)# attribute 49 1
```

or the command:

```
awplus(config-radsrv-group)# attribute acct-terminate-cause 1
```

You can define more than one instance of an attribute name (or id) by using the **repeated** parameter. For example:

```
awplus(config-radsrv-group)# attribute repeated  
Nas-filter-Rule "deny in tcp from any to 0.0.0.0/0 23"  
  
awplus(config-radsrv-group)# attribute repeated  
Nas-filter-Rule "deny in tcp from any to fe80::b1 23"
```

Examples To define the attribute name 'Service-Type' with Administrative User (6) to the RADIUS User Group 'Admin', use the following commands:

```
awplus# configure terminal  
awplus(config)# radius-server local  
awplus(config-radsrv)# group Admin  
awplus(config-radsrv-group)# attribute Service-Type 6
```

To delete the attribute 'Service-Type' from the RADIUS User Group 'Admin', use the following commands:

```
awplus# configure terminal  
awplus(config)# radius-server local  
awplus(config-radsrv)# group Admin  
awplus(config-radsrv-group)# no attribute Service-Type
```

To define multiple values for attribute 'NAS-Filter-Rule', use the commands:

```
awplus# configure terminal  
awplus(config)# radius-server local  
awplus(config-radsrv)# group dynamicAcl  
awplus(config-radsrv-group)# attribute repeated  
NAS-Filter-Rule "deny in tcp from any to 0.0.0.0/0 23"  
awplus(config-radsrv-group)# attribute repeated  
NAS-Filter-Rule "deny in tcp from any to fe80::b1 23"
```

To delete a specific value from the attribute 'NAS-Filter-Rule', use the commands:

```
awplus# configure terminal  
awplus(config)# radius-server local  
awplus(config-radsrv)# group dynamicAcl  
awplus(config-radsrv-group)# no attribute NAS-Filter-Rule "deny  
in tcp from any to 0.0.0.0/0 23"
```

**Related
commands**

[egress-vlan-id \(radsrv-grp\)](#)
[egress-vlan-name \(radsrv-grp\)](#)
[help radius-attribute](#)

**Command
changes**

Version 5.5.0-1.1: **repeated** parameter added

authentication

Overview Use this command to enable the specified authentication methods on the local RADIUS server.

Use the **no** variant of this command to disable specified authentication methods on the local RADIUS server.

Syntax authentication {mac|eapmd5|eaptls|peap}
no authentication {mac|eapmd5|eaptls|peap}

Parameter	Description
mac	Enable MAC authentication method.
eapmd5	Enable EAP-MD5 authentication method.
eaptls	Enable EAP-TLS authentication method.
peap	Enable EAP-PEAP authentication method.

Default All authentication methods are enabled by default.

Mode RADIUS Server Configuration

Examples The following commands enable EAP-MD5 authentication methods on the local RADIUS server.

```
awplus# configure terminal
awplus(config)# radius-server local
awplus(config-radsrv)# authentication eapmd5
```

The following commands disable EAP-MD5 authentication methods on Local RADIUS server.

```
awplus# configure terminal
awplus(config)# radius-server local
awplus(config-radsrv)# no authentication eapmd5
```

Related commands [server enable](#)
[show radius local-server statistics](#)

client (radsecproxy-srv)

Overview Use this command to add a RadSec client (for example, a NAS device) to the RadSecProxy local-server application. The application will accept RADIUS requests from all configured clients.

Use the **no** variant of this command to delete a previously-configured client from the RadSecProxy local-server application.

Syntax `client {<hostname>|<ip-addr>} [name-check {on|off}]`
`no client {<hostname>|<ip-addr>}`

Parameter	Description
<hostname>	Hostname of client.
<ip-addr>	Specify the client IPv4 address, in dotted decimal notation (A.B.C.D).
name-check	Specify whether or not to enforce certificate name checking for this client. If the parameter is not specified then the global behavior, which defaults to on , is used.
on	Enable name checking for this client.
off	Disable name checking for this client.

Mode RadSecProxy Local Server Configuration

Usage notes The client may be specified by its domain name or by its IPv4 address. If a domain name is used, it must be resolvable using a configured DNS name server.

Each client may be configured to use certificate name-checking; if not specified, the global behavior defined by **client name-check** or **no client name-check** will be used. If name checking is enabled, the Common Name portion of the subject field of the client's X.509 certificate must match the domain name or IP address specified in this command.

NOTE: *If mutual authentication is disabled then this parameter has no effect, see the [client mutual-authentication](#) command.*

Example To add a client called 'mynas.local' with certificate name checking **off**, use the commands:

```
awplus# configure terminal
awplus(config)# radius-secure-proxy local-server
awplus(config-radsecproxy-srv)# client mynas.local name-check
off
```

Related commands [client mutual-authentication](#)
[client name-check](#)

client trustpoint
radius-secure-proxy local-server

client mutual-authentication

Overview This command enables or disables mutual certificate authentication for all RadSecProxy clients. When enabled, the RadSecProxy local-server application will request and validate an X.509 certificate from the client when establishing a connection.

The **no** variant of this command disables mutual certificate validation. The local-server application will still transmit the local server certificate to the client, but will not expect or validate a certificate from the client.

Syntax `client mutual-authentication`
`no client mutual-authentication`

Default Mutual authentication is enabled by default.

Mode RadSecProxy Local Server Configuration

Example Disable mutual certificate validation with the following command:

```
awplus# configure terminal
awplus(config)# radius-secure-proxy local-server
awplus(config-radsecproxy-srv)# no client
mutual-authentication
```

Related commands [client \(radsecproxy-srv\)](#)
[client name-check](#)
[radius-secure-proxy local-server](#)

Command changes Version 5.4.6-2.1: command added

client name-check

Overview This command sets the global behavior for certificate name-checking for the RadSecProxy localserver application to **on**. This behavior will be used for all clients associated with the application that do not specify a behavior on a per-client basis. If name-checking is enabled, the Common Name portion of the subject field of the client's X.509 certificate must match the domain name or IP address specified in the **client (radsecproxy-aaa)** command.

Use the **no** variant of this command to set the global behavior for certificate name checking to **off**

Syntax `client name-check`
`no client name-check`

Default Certificate name checking is on by default.

Mode RadSecProxy Local Server Configuration

Example Disable certificate name checking globally with the following command:

```
awplus# configure terminal
awplus(config)# radius-secure-proxy local-server
awplus(config-radsecproxy-srv)# no client name-check
```

Related commands [client \(radsecproxy-srv\)](#)
[client trustpoint](#)
[radius-secure-proxy local-server](#)

client trustpoint

Overview This command adds one or more trustpoints to be used with the RadSecProxy local-server application. Multiple trustpoints may be specified, or the command may be executed more than once, to add multiple trustpoints to the application.

The **no** version of this command removes one or more trustpoints from the list of trustpoints associated with the application.

Syntax `client trustpoint [<trustpoint-list>]`
`no client trustpoint [<trustpoint-list>]`

Parameter	Description
<trustpoint-list>	Specify one or more trustpoints to be added or deleted.

Mode RadSecProxy Local Server Configuration

Usage notes The device certificate associated with the first trustpoint added to the application will be transmitted to remote servers. The certificate received from the remote server must have an issuer chain that terminates with the root CA certificate for any of the trustpoints that are associated with the application.

If you enter **client trustpoint** without specifying a trustpoint, the trustpoint list will be unchanged.

If you enter **no client trustpoint** without specifying a trustpoint, all trustpoints will be disassociated from the application.

Example You can add multiple trustpoints to the RadSecProxy local-server by executing the command multiple times:

```
awplus# configure terminal
awplus(config)# radius-secure-proxy local-server
awplus(config-radsecproxy-srv)# client trustpoint example_1
awplus(config-radsecproxy-srv)# client trustpoint example_2
```

Alternatively, add multiple trustpoints with a single command:

```
awplus(config-radsecproxy-srv)# client trustpoint example_3
example_4
```

Disassociate all trustpoints from the RadSecProxy local-server application using the command:

```
awplus(config-radsecproxy-srv)# no client trustpoint
```

Related commands [client \(radsecproxy-srv\)](#)
[client name-check](#)
[radius-secure-proxy local-server](#)

clear radius local-server statistics

Overview Use this command to clear the statistics stored on the device for the local RADIUS server.

Use this command without any parameters to clear all types of local RADIUS server statistics.

Syntax `clear radius local-server statistics [nas|server|user]`

Parameter	Description
nas	Clear the NAS (Network Access Server) statistics on the device. For example, clearing statistics stored for NAS server invalid passwords.
server	Clear the Local RADIUS Server statistics on the device. For example, clearing Local RADIUS Servers statistics for all failed login attempts.
user	Clear the Local RADIUS Server user statistics. For example, clearing statistics stored for the number of successful user logins.

Mode Privileged Exec

Usage Refer to the sample output for the [show radius local-server statistics](#) for further information about the type of statistics each parameter option for this command clears. Both the **nas** and **server** parameters clear unknown username and invalid passwords statistics, while the **user** parameter clears the number of successful and failed logins for each local RADIUS server user.

Examples To clear the NAS (Network Access Server) statistics stored on the device, use the command:

```
awplus# clear radius local-server statistics nas
```

To clear the local RADIUS server statistics stored on the device, use the command:

```
awplus# clear radius local-server statistics server
```

To clear the local RADIUS server user statistics stored on the device, use the command:

```
awplus# clear radius local-server statistics user
```

Related commands [show radius local-server statistics](#)

copy fdb-radius-users (to file)

Overview Use this command to create a set of local RADIUS server users from MAC addresses in the local FDB. A local RADIUS server user created using this command can be used for MAC authentication.

Syntax `copy fdb-radius-users
{local-radius-user-db|nvs|flash|usb|debug|tftp|scp|
fserver|<url>} [interface <port>] [vlan <vid>] [group <name>]
[export-vlan [<radius-group-name>]]`

Parameter	Description
local-radius-user-db	Copy the local RADIUS server users created to the local RADIUS server.
nvs	Copy the local RADIUS server users created to NVS memory.
flash	Copy the local RADIUS server users created to Flash memory.
usb	Copy the local RADIUS server users created to USB storage device.
debug	Copy the local RADIUS server users created to debug.
tftp	Copy the local RADIUS server users created to the TFTP destination.
scp	Copy the local RADIUS server users created to the SCP destination.
fserver	Copy the local RADIUS server users created to the remote file server.
<url>	Copy the local RADIUS server users created to the specified URL.
interface <port>	Copy only MAC addresses learned on a specified device port. Wildcards may be used when specifying an interface name.
vlan <vid>	Copy only MAC addresses learned on a specified VLAN.
group <name>	Assign a group name to the local RADIUS server users created.
export-vlan	Export VLAN ID assigned to exported FDB entry.
<radius-group-name>	Prefix for Radius group name storing VLAN ID

Mode Privileged Exec

Usage notes The local RADIUS server users created are written to a specified destination file in local RADIUS user CSV (Comma Separated Values) format. The local RADIUS server users can then be imported to a local RADIUS server using the [copy local-radius-user-db \(from file\)](#) command.

The name and password of the local RADIUS server users created use a MAC address, which can be used for MAC authentication.

This command does not copy a MAC address learned by the CPU or the management port.

This command can filter FDB entries by the interface name and the VLAN ID. When the interface name and the VLAN ID are specified, this command generates local RADIUS server users from only the MAC address learned on the specified interface and on the specified VLAN.

Examples To register the local RADIUS server users from the local FDB directly to the local RADIUS server, use the command:

```
awplus# copy fdb-radius-users local-radius-user-db
```

To register the local RADIUS server users from the interface port1.0.1 to the local RADIUS server, use the command:

```
awplus# copy fdb-radius-users local-radius-user-db interface port1.0.1
```

To copy output generated as local RADIUS server user data from MAC addresses learned on vlan10 on interface port1.0.1 to the file radius-user.csv, use the command:

```
awplus# copy fdb-radius-users radius-user.csv interface port1.0.1 vlan10
```

To copy output generated as local RADIUS server user data from MAC addresses learned on vlan10 on interface port1.0.1 to a file on the remote file server, use the command:

```
awplus# copy fdb-radius-users fserver interface port1.0.1 vlan10
```

Related commands [copy local-radius-user-db \(to file\)](#)
[copy local-radius-user-db \(from file\)](#)

copy local-radius-user-db (from file)

Overview Use this command to copy the Local RADIUS server user data from a file. The file, including the RADIUS user data in the file, must be in the CSV (Comma Separated Values) format.

You can select **add** or **replace** as the copy method. The **add** parameter option copies the contents of specified file to the local RADIUS server user database. If the same user exists then the old user is removed before adding a new user. The **replace** parameter option deletes all contents of the local RADIUS server user database before copying the contents of specified file.

Syntax `copy <source-url> local-radius-user-db [add|replace]`

Parameter	Description
<code><source-url></code>	URL of the source file.
<code>add</code>	Add file contents to local RADIUS server user database.
<code>replace</code>	Replace current local RADIUS server user database with file contents.

Default When no copy method is specified with this command the **replace** option is applied.

Mode Privileged Exec

Examples To replace the current local RADIUS server user data to the contents of `http://datahost/ user.csv`, use the following command:

```
awplus# copy http://datahost/user.csv local-radius-user-db
```

To add the contents of `http://datahost/user.csv` to the current local RADIUS server user database, use the following command:

```
awplus# copy http://datahost/user.csv local-radius-user-db add
```

Related commands [copy fdb-radius-users \(to file\)](#)
[copy local-radius-user-db \(to file\)](#)

copy local-radius-user-db (to file)

Overview Use this command to copy the local RADIUS server user data to a file. The output file produced is CSV (Comma Separated Values) format.

Syntax `copy local-radius-user-db
{nvs|flash|usb|tftp|scp|<destination-url>}`

Parameter	Description
nvs	Copy to NVS memory.
flash	Copy to Flash memory.
usb	Copy to USB storage device.
tftp	Copy to TFTP destination.
scp	Copy to SCP destination.
<destination-url>	URL of the Destination file.

Mode Privileged Exec

Example Copy the current local RADIUS server user data to `http://datahost/user.csv`.

```
awplus# copy local-radius-user-db http://datahost/user.csv
```

Related commands [copy fdb-radius-users \(to file\)](#)
[copy local-radius-user-db \(from file\)](#)

crypto pki enroll local (deleted)

Overview This command is no longer available. Please use the following command instead:

```
crypto pki enroll <trustpoint>
```

Note that “local” is a valid name for a trustpoint, so you do not need to modify existing configurations or scripts.

crypto pki enroll local local-radius-all-users (deleted)

Overview This command is no longer available. Please use the following command instead:

```
crypto pki enroll <trustpoint> local-radius-all-users
```

Note that "local" is a valid name for a trustpoint, so you do not need to modify existing configurations or scripts.

crypto pki enroll local user (deleted)

Overview This command is no longer available. Please use the following command instead:

```
crypto pki enroll <trustpoint> user <username>
```

Note that “local” is a valid name for a trustpoint, so you do not need to modify existing configurations or scripts.

crypto pki export local pem (deleted)

Overview This command is no longer available. Please use the [crypto pki export pem](#) command instead:

```
crypto pki export <trustpoint> pem [terminal|<url>]
```

Note that "local" is a valid name for a trustpoint, so you do not need to modify existing configurations or scripts.

crypto pki export local pkcs12 (deleted)

Overview This command is no longer available. Please use the [crypto pki export pkcs12](#) command instead:

```
crypto pki export <trustpoint> pkcs12 {ca|server|<username>}  
<url>
```

Note that "local" is a valid name for a trustpoint, so you do not need to modify existing configurations or scripts.

crypto pki trustpoint local (deleted)

Overview This command is no longer available. Please use the following command instead:

```
crypto pki trustpoint <trustpoint>
```

Note that "local" is a valid name for a trustpoint, so you do not need to modify existing configurations or scripts.

debug crypto pki (deleted)

Overview This command is no longer available.

domain-style

Overview Use this command to enable a specified domain style on the local RADIUS server. The local RADIUS server decodes the domain portion of a username login string when this command is enabled.

Use the **no** variant of this command to disable the specified domain style on the local RADIUS server.

Syntax `domain-style {suffix-atsign|ntdomain}`
`no domain-style {suffix-atsign|ntdomain}`

Parameter	Description
<code>suffix-atsign</code>	Enable at sign "@" delimited suffix style, i.e. "user@domain".
<code>ntdomain</code>	Enable NT domain style, i.e. "domain\user".

Default This feature is disabled by default.

Mode RADIUS Server Configuration

Usage notes When both domain styles are enabled, the first domain style configured has the highest priority. A username login string is matched against the first domain style enabled. Then, if the username login string is not decoded, it is matched against the second domain style enabled.

Examples To enable NT domain style on the local RADIUS server, use the commands:

```
awplus# configure terminal
awplus(config)# radius-server local
awplus(config-radsrv)# domain-style ntdomain
```

To disable NT domain style on the local RADIUS server, use the commands:

```
awplus# configure terminal
awplus(config)# radius-server local
awplus(config-radsrv)# no domain-style ntdomain
```

Related commands [server enable](#)

egress-vlan-id (radsrv-grp)

Overview Use this command to configure the standard RADIUS attribute 'Egress-VLANID (56)' for the local RADIUS Server user group.

Use the **no** variant of this command to remove the Egress-VLANID attribute from the local RADIUS server user group.

Syntax egress-vlan-id <vid> [tagged|untagged]
no egress-vlan-id

Parameter	Description
<vid>	The VLAN identifier to be used for the Egress VLANID attribute, in the range 1 to 4094.
tagged	Set frames on the VLAN as tagged. This sets the tag indication field to indicate that all frames on this VLAN are tagged.
untagged	Set all frames on the VLAN as untagged. This sets the tag indication field to indicate that all frames on this VLAN are untagged.

Default By default, no Egress-VLANID attributes are configured.

Mode Local RADIUS Server User Group Configuration

Examples To set the 'Egress-VLANID' attribute for the 'NormalUsers' local RADIUS server user group to VLAN identifier 200, with tagged frames, use the commands:

```
awplus# configure terminal
awplus(config)# radius-server local
awplus(config-radsrv)# group NormalUsers
awplus(config-radsrv-group)# egress-vlan-id 200 tagged
```

To remove the 'Egress-VLANID' attribute for the 'NormalUsers' local RADIUS server user group, use the commands:

```
awplus# configure terminal
awplus(config)# radius-server local
awplus(config-radsrv)# group NormalUsers
awplus(config-radsrv-group)# no egress-vlan-id
```

Related commands [attribute \(radsrv-grp\)](#)
[egress-vlan-name \(radsrv-grp\)](#)

egress-vlan-name (radsrv-grp)

Overview Use this command to configure the standard RADIUS attribute 'Egress-VLAN-Name (58)' for the local RADIUS server user group.

Use the **no** variant of this command to remove the Egress-VLAN-Name attribute from the local RADIUS server user group.

Syntax egress-vlan-name <vlan-name> [tagged|untagged]
no egress-vlan-name

Parameter	Description
<vlan-name>	The VLAN name to be configured as the Egress-VLAN-Name attribute.
tagged	Set frames on the VLAN as tagged. This sets the tag indication field to indicate that all frames on this VLAN are tagged.
untagged	Set all frames on the VLAN as untagged. This sets the tag indication field to indicate that all frames on this VLAN are untagged.

Default By default, no Egress-VLAN-Name attributes are configured.

Mode Local RADIUS Server User Group Configuration

Examples To configure the 'Egress-VLAN-Name' attribute for the RADIUS server user group 'NormalUsers' with the VLAN name vlan2 and all frames on this VLAN tagged, use the commands:

```
awplus# configure terminal
awplus(config)# radius-server local
awplus(config-radsrv)# group NormalUsers
awplus(config-radsrv-group)# egress-vlan-name vlan2 tagged
```

To delete the 'Egress-VLAN-Name' attribute for the 'NormalUsers' group, use the commands:

```
awplus# configure terminal
awplus(config)# radius-server local
awplus(config-radsrv)# group NormalUsers
awplus(config-radsrv-group)# no egress-vlan-name
```

Related commands [attribute \(radsrv-grp\)](#)
[egress-vlan-id \(radsrv-grp\)](#)

group (radsrv)

Overview Use this command to create a local RADIUS server user group, and enter local RADIUS Server User Group Configuration mode.

Use the **no** variant of this command to delete the local RADIUS server user group.

Syntax `group <user-group-name>`
`no group <user-group-name>`

Parameter	Description
<code><user-group-name></code>	User group name string.

Mode RADIUS Server Configuration

Examples The following command creates the user group NormalUsers.

```
awplus# configure terminal
awplus(config)# radius-server local
awplus(config-radsrv)# group NormalUsers
```

The following command deletes the user group NormalUsers.

```
awplus# configure terminal
awplus(config)# radius-server local
awplus(config-radsrv)# no group NormalUsers
```

Related commands [user \(radsrv\)](#)
[show radius local-server user](#)
[vlan \(radsrv-grp\)](#)

nas

Overview This command adds a client device (the Network Access Server or the NAS) to the list of devices that are able to send authentication requests to the local RADIUS server. The NAS is identified by its IP address and a shared secret (also referred to as a shared key) must be defined that the NAS will use to establish its identity.

Use the **no** variant of this command to remove a NAS client from the list of devices that are allowed to send authentication requests to the local RADIUS server.

Syntax `nas <ip-address> key <nas-keystring>`
`no nas <ip-address>`

Parameter	Description
<code><ip-address></code>	RADIUS NAS IP address.
<code><nas-keystring></code>	NAS shared keystring.

Mode RADIUS Server Configuration

Examples The following commands add the NAS with an IP address of 192.168.1.2 to the list of clients that may send authentication requests to the local RADIUS server. Note the shared key that this NAS will use to establish its identify is NAS_PASSWORD.

```
awplus# configure terminal
awplus(config)# radius-server local
awplus(config-radsrv)# nas 192.168.1.2 key NAS_PASSWORD
```

The following commands remove the NAS with an IP address of 192.168.1.2 from the list of clients that are allowed to send authentication requests to the local RADIUS server:

```
awplus# configure terminal
awplus(config)# radius-server local
awplus(config-radsrv)# no nas 192.168.1.2
```

Related commands [show radius local-server nas](#)

help radius-attribute

Overview Use this command to display a list of standard and vendor specific valid RADIUS attributes that are supported by the local RADIUS server.

Syntax `help radius-attribute [<attribute-name>|<attribute-ID>]`

Parameter	Description
<code><attribute-name></code>	List the details and predefined values for the named attribute.
<code><attribute-ID></code>	List the details and predefined values for the given attribute ID.

Mode Privileged Exec

Usage notes When used without a parameter, this command lists all of the available RADIUS attributes.

When used with an attribute name or ID, this command displays the attribute name, value type, and any predefined values.

Example To list all available RADIUS attributes, use the following command:

```
awplus# help radius-attribute
```

```
awplus#help radius-attribute
Standard Attributes:
 1      User-Name
 2      User-Password
 3      CHAP-Password
 4      NAS-IP-Address
 5      NAS-Port
 6      Service-Type
...
```

To display the details for the RADIUS attribute Frag-Status, use the following command:

```
awplus# help radius-attribute frag-status
```

```
awplus#help radius-attribute frag-status
Frag-Status : integer (Integer number)

Pre-defined values :
  Fragmentation-Supported (1)
  More-Data-Pending (2)
  More-Data-Request (3)
  Reserved (0)
```

Related commands [attribute \(radsrv-grp\)](#)

Command changes Version 5.4.8-0.2: command added
Version 5.4.9-0.1: added to x530 Series products

radius-secure-proxy local-server

Overview Use this command to enter the RadSecProxy local-server application configuration mode. This application allows remote RadSec clients to communicate with the local RADIUS server process via a secure (TLS) proxy.

Syntax `radius-secure-proxy local-server`

Mode Global Configuration Mode

Example To change mode from User Exec mode to the RadSecProxy local-server configuration mode, use the commands:

```
awplus# configure terminal
awplus(config)# radius-secure-proxy local-server
awplus(config-radsecproxy-srv)#
```

Related commands

- [client \(radsecproxy-srv\)](#)
- [client name-check](#)
- [client trustpoint](#)

radius-server local

Overview Use this command to navigate to the Local RADIUS server configuration mode (`config-radsrv`) from the Global Configuration mode (`config`).

Syntax `radius-server local`

Mode Global Configuration

Example Local RADIUS Server commands are available from `config-radsrv` configuration mode. To change mode from User Exec mode to the Local RADIUS Server mode (`config-radsrv`), use the commands:

```
awplus# configure terminal
awplus(config)# radius-server local
awplus(config-radsrv)#
```

Output

```
awplus(config)#radius-server local
Creating Local CA repository.....OK
Enrolling Local System to local trustpoint..OK
awplus(config-radsrv)#
```

Related commands

- [server enable](#)
- [show radius local-server group](#)
- [show radius local-server nas](#)
- [show radius local-server statistics](#)
- [show radius local-server user](#)

server auth-port

Overview Use this command to change the UDP port number for local RADIUS server authentication.

Use the **no** variant of this command to reset the RADIUS server authentication port back to the default.

Syntax `server auth-port <1-65535>`
`no server auth-port`

Parameter	Description
<1-65535>	UDP port number.

Default The default local RADIUS server UDP authentication port number is 1812.

Mode RADIUS Server Configuration

Examples The following commands set the RADIUS server authentication port to 10000.

```
awplus# configure terminal
awplus(config)# radius-server local
awplus(config-radsrv)# server auth-port 10000
```

The following commands reset the RADIUS server authentication port back to the default UDP port of 1812.

```
awplus# configure terminal
awplus(config)# radius-server local
awplus(config-radsrv)# no server auth-port
```

Related commands [server enable](#)
[show radius local-server statistics](#)

server enable

Overview This command enables the local RADIUS server. The local RADIUS server feature is started immediately when this command is issued.

The **no** variant of this command disables local RADIUS server. When this command is issued, the local RADIUS server stops operating.

Syntax `server enable`
`no server enable`

Default The local RADIUS server is disabled by default and must be enabled for use with this command.

Mode RADIUS Server Configuration

Examples To enable the local RADIUS server, use the following commands:

```
awplus# configure terminal
awplus(config)# radius-server local
awplus(config-radsrv)# server enable
```

To disable the local RADIUS server, use the command:

```
awplus# configure terminal
awplus(config)# radius-server local
awplus(config-radsrv)# no server enable
```

Related commands [server auth-port](#)
[show radius local-server statistics](#)

show radius local-server group

Overview Use this command to display information about the local RADIUS server user group.

For information on filtering and saving command output, see the [“Getting Started with AlliedWare Plus” Feature Overview and Configuration Guide](#).

Syntax `show radius local-server group [<user-group-name>]`

Parameter	Description
<user-group-name>	User group name string.

Mode User Exec and Privileged Exec

Example The following command displays Local RADIUS server user group information.

```
awplus# show radius local-server group
```

Output

Table 1: Example output from the **show radius local-server group** command

Group-Name	Vlan

NetworkOperators	ManagementNet
NormalUsers	CommonNet

Table 2: Parameters in the output of the **show radius local-server group** command

Parameter	Description
Group-Name	Group name.
Vlan	VLAN name assigned to the group.

Related commands [group \(radsrv\)](#)

show radius local-server nas

Overview Use this command to display information about NAS (Network Access Servers) registered to the local RADIUS server.

For information on filtering and saving command output, see the [“Getting Started with AlliedWare Plus” Feature Overview and Configuration Guide](#).

Syntax `show radius local-server nas [<ip-address>]`

Parameter	Description
<code><ip-address></code>	Specify NAS IP address for show output.

Mode User Exec and Privileged Exec

Example The following command displays NAS information.

```
awplus# show radius local-server nas
```

Output

Table 3: Example output from the **show radius local-server nas** command

NAS-Address	Shared-Key
127.0.0.1	awplus-local-radius-server

Table 4: Parameters in the output of the **show radius local-server nas** command

Parameter	Description
NAS-Address	IP address of NAS.
Shared-Key	Shared key used for RADIUS connection.

Related commands `nas`

show radius local-server statistics

Overview Use this command to display statistics about the local RADIUS server.
For information on filtering and saving command output, see the [“Getting Started with AlliedWare Plus” Feature Overview and Configuration Guide](#).

Syntax `show radius local-server statistics`

Mode User Exec and Privileged Exec

Usage notes Both unknown usernames and invalid passwords will display as failed logins in the show output.

Example The following command displays Local RADIUS server statistics.

```
awplus# show radius local-server statistics
```

Output

Table 5: Example output from the **show radius local-server statistics** command

```
Server status      : Run (administrative status is enable)
Enabled methods   : MAC EAP-MD5 EAP-TLS EAP-PEAP
Available methods : MAC EAP-MD5 EAP-TLS EAP-PEAP
EAP trustpoints   : local

Successes          :1                Unknown NAS          :0
Failed Logins      :0                Invalid packet from NAS :0
Internal Error     :0                Unknown Error        :0

NAS : 127.0.0.1
Successes          :0                Shared key mismatch   :0
Failed Logins      :0                Unknown RADIUS message :0
Unknown EAP message :0                Unknown EAP auth type  :0
Corrupted packet   :0

NAS : 192.168.1.61
Successes          :0                Shared key mismatch   :0
Failed Logins      :0                Unknown RADIUS message :0
Unknown EAP message :0                Unknown EAP auth type  :0
Corrupted packet   :0

Username  Successes  Failures
Tom       1          0
admin    0          0
```

Related commands [clear radius local-server statistics](#)
[radius-server local](#)
[server enable](#)
[server auth-port](#)

show radius local-server user

Overview Use this command to display information about the local RADIUS server user.

For information on filtering and saving command output, see the [“Getting Started with AlliedWare Plus” Feature Overview and Configuration Guide](#).

Syntax

```
show radius local-server user [<user-name>]  
show radius local-server user [<user-name>] format csv  
show radius local-server user [<user-name>] detail
```

Parameter	Description
<user-name>	RADIUS user name. If no user name is specified, information for all users is displayed.
format csv	Format output as CSV. This parameter is only available in Privileged Exec mode.
detail	Display detailed information about the user.

Mode User Exec and Privileged Exec

Examples The following command displays Local RADIUS server user information for user Tom.

```
awplus# show radius local-server user Tom
```

Table 6: Example output from the **show radius local-server user** command

User-Name	Group	Vlan
Tom	NetworkOperators	ManagementNet

The following command displays all Local RADIUS server information for all users.

```
awplus# show radius local-server user
```

The following command displays Local RADIUS server user information for Tom in CSV format (only available in Privileged Exec mode).

```
awplus# show radius local-server user Tom format csv
```

Table 7: Example output from the **show radius local-server user Tom format csv** command

true,"NetworkOperators","Tom","abcd",0,2099/01/01,1,"","","ManagementNet"false,3600,false,0,"",false,"",false,false,"","",false,false,,false,0,0,"",true
--

The following command displays detailed Local RADIUS server user information for all users.

```
awplus# show radius local-server user detail
```

Table 8: Example output from the **show radius local-server user detail** command

```
awplus# show radius local-server user detail
Total users: 1
Maximum users allowed by license: 3
-----
Username   : Tom
Group      : NetworkOperators
Vlan       : VlanName
```

Table 9: Parameters in the output from the **show radius local-server user** command

Parameter	Description
User-Name	User name.
Group	Group name assigned to the user.
Vlan	VLAN name assigned to the user.

Related commands [group \(radsrv\)](#)
[user \(radsrv\)](#)

Command changes Version 5.4.9-0.1: **detail** parameter added

user (radsrv)

Overview Use this command to register a user to the local RADIUS server.
Use the **no** variant of this command to delete a user from the local RADIUS server.

Syntax `user <radius-user-name> [encrypted] password <user-password>
[group <user-group>]`
`no user <radius-user-name>`

Parameter	Description
<code><radius-user-name></code>	RADIUS user name. This can also be a MAC address in the IEEE standard format of HH-HH-HH-HH-HH-HH if you are configuring MAC authentication to use local RADIUS server.
<code>encrypted</code>	Specifies that the password is being entered in its encrypted form, so that it is not further encrypted. When creating a new user, enter the password in plaintext, and do not use the encrypted parameter. Use the encrypted parameter only when referring to a user that has previously been created. For instance, when adding an existing user from another RADIUS server, use the encrypted parameter, and enter the encrypted version of the password that appears in the output of show commands for the user.
<code><user-password></code>	User password. This can also be a MAC address in the IEEE standard format of HH-HH-HH-HH-HH-HH if you are configuring MAC authentication to use local RADIUS server.
<code>group</code>	Specify the group for the user.
<code><user-group></code>	User group name.

Mode RADIUS Server Configuration

Usage notes RADIUS user names cannot contain question mark (?), space (), or quote (" ") characters. RADIUS user names containing the below characters cannot use certificate authentication:

`/ \ '$ & () * ; < > ` |`

Certificates cannot be created and exported for RADIUS user names that contain the above characters. We advise you to avoid using these characters in RADIUS user names if you need to use certificate authentication, because you will not be able to create and export certificates.

You also can use the IEEE standard format hexadecimal notation (HH-HH-HH-HH-HH-HH) to specify a supplicant MAC address to configure the user name and user password parameters to use local RADIUS server for MAC Authentication. See the [AAA and Port_Authentication Feature Overview and Configuration_Guide](#) for a sample MAC configuration. See also the command **user**

00-db-59-ab-70-37 password 00-db-59-ab-70-37 as shown in the command examples.

Examples The following commands add user 'Tom' to the local RADIUS server and sets his password to 'QwerSD'.

```
awplus# configure terminal
awplus(config)# radius-server local
awplus(config-radsrv)# user Tom password QwerSD
```

The following commands add user 'Tom' to the local RADIUS server user group 'NormalUsers' and sets his password 'QwerSD'.

```
awplus# configure terminal
awplus(config)# radius-server local
awplus(config-radsrv)# user Tom password QwerSD group
NormalUsers
```

The following commands remove user 'Tom' from the local RADIUS server:

```
awplus# configure terminal
awplus(config)# radius-server local
awplus(config-radsrv)# no user Tom
```

The following commands add the supplicant MAC address 00-d0-59-ab-70-37 to the local RADIUS server:

```
awplus# configure terminal
awplus(config)# radius-server local
awplus(config-radsrv)# user 00-db-59-ab-70-37 password
00-db-59-ab-70-37
```

The following commands remove the supplicant MAC address 00-d0-59-ab-70-37 from the local RADIUS server:

```
awplus# configure terminal
awplus(config)# radius-server local
awplus(config-radsrv)# no user 00-db-59-ab-70-37
```

Related commands [group \(radsrv\)](#)
[show radius local-server user](#)

vlan (radsrv-grp)

Overview Use this command to set the VLAN ID or name for the local RADIUS server user group. The VLAN information is used for authentication with the dynamic VLAN feature.

Use the **no** variant of this command to clear the VLAN ID or VLAN name for the local RADIUS server user group.

Syntax `vlan {<vid>|<vlan-name>}`
`no vlan`

Parameter	Description
<code><vid></code>	VLAN ID.
<code><vlan-name></code>	VLAN name.

Default VLAN information is not set by default.

Mode Local RADIUS Server User Group Configuration

Examples The following commands set VLAN ID 200 to the group named 'NormalUsers':

```
awplus# configure terminal
awplus(config)# radius-server local
awplus(config-radsrv)# group NormalUsers
awplus(config-radsrv-group)# vlan 200
```

The following commands remove VLAN ID 200 from the group named 'NormalUsers':

```
awplus# configure terminal
awplus(config)# radius-server local
awplus(config-radsrv)# group NormalUsers
awplus(config-radsrv-group)# no vlan
```

Related commands [group \(radsrv\)](#)
[show radius local-server user](#)

46

Two-factor Authentication (2FA) Commands

Introduction

Overview This chapter provides an alphabetical reference of commands used to configure two-factor authentication (2FA).

2FA is a method of strengthening security by requiring a second method of authentication. AlliedWare Plus supports 2FA on OpenVPN connections. It requires a software-based authenticator that implements either the time-based one-time password (TOTP) or the HMAC-based one-time password (HOTP) algorithms. These software authenticators (known as authenticator apps) are usually loaded on a mobile device. One well-known implementation of such an app is Google Authenticator.

For more information on configuring 2FA on OpenVPN, see the “Two-factor authentication” chapter in the [OpenVPN Feature Overview and Configuration Guide](#).

- Command List**
- “2fa allow-reuse” on page 2386
 - “2fa create user” on page 2387
 - “2fa delete user” on page 2389
 - “2fa hotp-window-size” on page 2390
 - “2fa issuer” on page 2391
 - “2fa label” on page 2393
 - “2fa max-skew” on page 2395
 - “2fa reject-unconfigured-users” on page 2396
 - “2fa reset scratch-codes” on page 2397
 - “2fa reset skew” on page 2398
 - “2fa skew adjust” on page 2399
 - “2fa totp-window-size” on page 2401
 - “debug 2fa” on page 2402

- [“service 2fa”](#) on page 2403
- [“show 2fa”](#) on page 2405
- [“show 2fa user”](#) on page 2406
- [“show 2fa users”](#) on page 2408
- [“show debugging 2fa”](#) on page 2409

2fa allow-reuse

Overview Use this command, when configuring two-factor authentication (2FA), to allow the reuse of time-based codes within the acceptable time window. By default, if a code has already been used then it will be rejected. This means the user must wait for the next code to appear in their authenticator app to be able to login.

Use the **no** variant of this command to return to the default state, which is to reject codes that have already been used.

Syntax `2fa allow-reuse`
`no 2fa allow-reuse`

Default Disabled

Mode Global Configuration

Usage notes The 2FA service must be running for this command to work. Enable it with the [service 2fa](#) command.

Example To allow the reuse of time-based codes, use the commands:

```
awplus# configure terminal
awplus(config)# 2fa allow-reuse
```

To prevent the reuse of time-based codes, use the commands:

```
awplus# configure terminal
awplus(config)# no 2fa allow-reuse
```

Related commands [2fa create user](#)
[2fa delete user](#)
[service 2fa](#)
[show 2fa](#)
[show 2fa user](#)
[show 2fa users](#)

Command changes Version 5.5.2-1.1: command added

2fa create user

Overview Use this command to create the two-factor authentication (2FA) data for a user. It allows you to set the authentication mode, HMAC-based One-Time Password (HOTP) or Time-based one-time password (TOTP), and displays a QR code and scratch codes for the user.

For more information on configuring 2FA on OpenVPN, see the “Two-factor authentication” chapter in the [OpenVPN Feature Overview and Configuration Guide](#).

Syntax `2fa create user <user-name> {random-secret|secret <secret-key>} [hotp] [qr {ansi|utf8|link}]`

Parameter	Description
<user-name>	The name of the user you are creating.
random-secret	Generate a random secret key.
secret	Use a pre-defined secret key.
<secret-key>	The pre-defined secret key.
hotp	Use HOTP mode for code verification (the default is TOTP).
qr	Display the QR code
ansi	Display the QR code using ANSI block characters.
utf8	Display the QR code using a UTF-8 mosaic.
link	Display a hyperlink for a QR code generator. Opening the link in a browser will display a QR code. As the string is passed to an online QR code generator (at Google), it may be a security concern for some installations.

Mode Privileged Exec

Usage notes You must enable the 2FA service, with the [service 2fa](#) command, before creating user data.

The QR code displays best in a color mode ANSI or UTF-8 terminal. If your terminal is insufficiently wide, or doesn't have the correct options enabled, you may not get a scannable QR code.

Example To create a user 'test', generate a random secret key, use HOTP mode, and display a QR link, use the command:

```
awplus# 2fa create user test random-secret hotp qr link
```

Output Figure 46-1: Example output from **2fa create user test random-secret hotp qr link**

```
awplus#2fa create user test random-secret hotp qr link
Two-Factor Authentication information for user:

Username:      test
Secret:        IWNZKQS2WXQ6I2VHGTUFP4IVA4
Mode:          HOTP (counter: 1)
OTP            URL:otpath://hotp/test@awplus?secret=IWNZKQS2WXQ6I2VHGTUFP4IVA4
Scratch codes:
59808697
25389232
71366922
48035778
82664010

The following URL can be used to generate a QR code.
This results in the user key being sent to Google servers.
https://www.google.com/chart?chs=200x200&chld=M|0&cht=qr&chl=otpath://hotp/test@awplus%3Fsecret%3DIWNZKQS2WXQ6I2VHGTUFP4IVA4awplus#
```

- Related commands**
- [2fa delete user](#)
 - [2fa reset skew](#)
 - [2fa reset scratch-codes](#)
 - [service 2fa](#)
 - [show 2fa](#)
 - [show 2fa user](#)
 - [show 2fa users](#)

Command changes Version 5.5.2-1.1: command added

2fa delete user

Overview Use this command to delete the two-factor authentication (2FA) data for a user.

Syntax `2fa delete user <user-name>`

Parameter	Description
<code><user-name></code>	The name of the user you are deleting.

Mode Privileged Exec

Example To delete the 2FA data for a user named 'test', use the command:

```
awplus# 2fa delete user test
```

Related commands

- [2fa create user](#)
- [2fa reset scratch-codes](#)
- [2fa reset skew](#)
- [service 2fa](#)
- [show 2fa user](#)
- [show 2fa users](#)

Command changes Version 5.5.2-1.1: command added

2fa hotp-window-size

Overview Use this command to set the range of acceptable codes for HMAC-based one-time password (HOTP) mode two-factor authentication (2FA). The window size is the number of codes checked, starting at the current stored counter value, and then checking forward.

Use the **no** variant of this command to reset the window size to the default of 3.

Syntax `2fa hotp-window-size <1-100>`
`no 2fa hotp-window-size`

Parameter	Description
<code><1-100></code>	The number of codes valid from the current counter value.

Default 3

Mode Global Configuration

Usage notes The stored counter value is the counter value after the last successfully verified code. If a code later in the window is detected, the stored counter is updated to that value. This helps keep the mobile authenticator app and device synchronized. For example, the default HOTP window size of 3 allows the device to accept the current code or the following 2 codes.

Example To set the window size to include codes for the current and next 4 counter values (a total of 5 codes), use the commands:

```
awplus# configure terminal
awplus(config)# 2fa hotp-window-size 5
```

To set the window size to the default value, use the commands:

```
awplus# configure terminal
awplus(config)# no 2fa hotp-window-size
```

Related commands

- [2fa create user](#)
- [2fa delete user](#)
- [2fa totp-window-size](#)
- [service 2fa](#)
- [show 2fa](#)
- [show 2fa user](#)
- [show 2fa users](#)

Command changes Version 5.5.2-1.1: command added

2fa issuer

Overview Use this command to set an optional issuer string that is used in the two-factor authentication (2FA) QR code. The issuer string will then be set in every user's QR code.

By default, the issuer string is not set.

Use the **no** variant of this command to set the issuer string to be empty.

Syntax `2fa issuer <issuer-name>`
`no 2fa issuer`

Parameter	Description
<code><issuer-name></code>	Text string to include in the OTP URL in the issuer field.

Default Issuer not set

Mode Global Configuration

Usage notes The Quick Response (QR) code is built from the OTP URL. The QR code can be used to load the shared secret into an authenticator app. The label and issuer strings affect how the entry is displayed in the authenticator app.

For example, in the URL below the issuer has been set to 'ATL':

```
OTP URL: otpauth://totp/test@awplus?secret=RIVS3...&issuer=ATL
```

Once the issuer has been changed it is possible to display a QR code for existing users, with the new issuer included, by using the [show 2fa user](#) command.

The 2FA service must be running for this command to work.

Example To set the issuer to 'ATL', use the commands:

```
awplus# configure terminal  
awplus(config)# 2fa issuer ATL
```

Related commands

- [2fa create user](#)
- [2fa delete user](#)
- [2fa label](#)
- [service 2fa](#)
- [show 2fa](#)
- [show 2fa user](#)
- [show 2fa users](#)

Command changes Version 5.5.2-1.1: command added

2fa label

Overview Use this command to set an optional label string that is used in the two-factor authentication (2FA) QR code. The label string will be set in every user's QR code.

By default the label is the system's host name.

Use the **no** variant of this command to set the label field back to the host name.

Syntax `2fa label <label-string>`
`no 2fa label`

Parameter	Description
<code><label-string></code>	Text string to include in the OTP URL in the label field.

Default System's host name

Mode Global Configuration

Usage notes The Quick Response (QR) code is built from the OTP URL. The QR code can be used to load the shared secret into an authenticator app. The label and issuer strings affect how the entry is displayed in the authenticator app.

The full label that AlliedWare Plus produces is `<username>@<label>`. For example, in the URL below the default host name is being used with user name 'test':

```
OTP URL: otpauth://totp/test@awplus?secret=RIVS3...&issuer=ATL
```

Once the label has been changed it is possible to display a QR code for existing users, with the new label included, by using the [show 2fa user](#) command.

The 2FA service must be running for this command to work.

Example To set the label to 'Company VPN', use the commands:

```
awplus# configure terminal
awplus(config)# 2fa label Company VPN
```

Related commands

- [2fa create user](#)
- [2fa delete user](#)
- [2fa issuer](#)
- [service 2fa](#)
- [show 2fa](#)
- [show 2fa user](#)
- [show 2fa users](#)

Command changes Version 5.5.2-1.1: command added

2fa max-skew

Overview Use this command to set the maximum time skew to be used by the time skew adjustment feature. The time skew adjustment feature is enabled with the [2fa skew adjust](#) command.

By default, 1500 extra codes are checked in each direction from the current time-step. This is 12.5 hours maximum skew in either direction (codes are generated in 30 second time-step intervals).

Use the **no** variant of this command to reset the maximum number of time-steps to check to 1500.

Syntax `2fa max-skew <120-3000>`
`no 2fa max-skew`

Parameter	Description
<code><120-3000></code>	Maximum number of 30 second time-steps to check.

Default 1500

Mode Global Configuration

Example To configure the time skew adjustment feature to check a maximum of one hour (i.e. 120 30 second time-steps), either side of the current time-step, use the commands:

```
awplus# configure terminal
awplus(config)# 2fa max-skew 120
```

To configure the time skew adjustment feature to check a maximum of 25 hours (i.e. 3000 30 second time-steps), either side of the current time-step, use the commands:

```
awplus# configure terminal
awplus(config)# 2fa max-skew 3000
```

Related commands

- [2fa reset skew](#)
- [2fa skew adjust](#)
- [service 2fa](#)
- [show 2fa](#)
- [show 2fa user](#)
- [show 2fa users](#)

Command changes Version 5.5.2-1.1: command added

2fa reject-unconfigured-users

Overview Use this command to deny authentication to users who have not been configured for two-factor authentication (2FA). By default, if a user is not configured for 2FA then 2FA will be skipped during the authentication process.

Use the **no** variant of this command to allow users to authenticate even if they are not configured for 2FA.

Syntax `2fa reject-unconfigured-users`
`no 2fa reject-unconfigured-users`

Default Users not configured for 2FA are allowed to authenticate.

Mode Global Configuration

Example To deny authentication to users who don't have 2FA configured, use the commands:

```
awplus# configure terminal
awplus(config)# 2fa reject-unconfigured-users
```

Related commands

- [2fa create user](#)
- [2fa delete user](#)
- [service 2fa](#)
- [show 2fa](#)
- [show 2fa user](#)
- [show 2fa users](#)

Command changes Version 5.5.2-1.1: command added

2fa reset scratch-codes

Overview Use this command to generate a set of five new scratch codes for a two-factor authentication (2FA) user. Each scratch code can only be used once.

Syntax `2fa reset scratch-codes user <user-name>`

Parameter	Description
<code>user</code>	Reset scratch codes for a user.
<code><user-name></code>	Name of the user you want to generate scratch codes for.

Mode Privileged Exec

Usage notes When a 2FA user is created, 5 scratch codes are created for that user. These are one time emergency codes that can be used in place of a code generated by the authenticator app. Once they are used, they can not be used again. Use this command to generate 5 new scratch codes for a user.

Example To reset the 2FA scratch codes for the user named 'test', use the command:

```
awplus# 2fa reset scratch-codes user test
```

Output Figure 46-2: Example output from **2fa reset scratch-codes user test**

```
Scratch codes:
 70344616
 91312817
 39931705
 89513481
 78647666
```

Related commands

- [2fa create user](#)
- [2fa delete user](#)
- [2fa reset skew](#)
- [show 2fa user](#)
- [show 2fa users](#)

Command changes Version 5.5.2-1.1: command added

2fa reset skew

Overview Use this command to reset the skew adjustment data for a two-factor authentication (2FA) user. Time skew adjustment data is recorded for a user if the time skew adjustment feature is enabled with the [2fa skew adjust](#) command.

Syntax `2fa reset skew user <user-name>`

Parameter	Description
<code>user</code>	Reset for a user.
<code><user-name></code>	The name of the user you want to reset.

Mode Privileged Exec

Example To reset the skew data for a user called 'test', use the command:

```
awplus# 2fa reset skew user test
```

Related commands

- [2fa max-skew](#)
- [2fa skew adjust](#)
- [service 2fa](#)
- [show 2fa](#)
- [show 2fa user](#)
- [show 2fa users](#)

Command changes Version 5.5.2-1.1: command added

2fa skew adjust

Overview Use this command to enable the time skew adjustment feature for time-based one-time password (TOTP) two-factor authentication (2FA).

TOTP authentication depends on the clock on the authenticating device and the clock on the authenticator app being synchronized. If there is a difference in time larger than what is covered by the TOTP window size then the client will not be able to authenticate. Time skew adjustment provides a method to detect and store this time difference and allow them to authenticate if it is consistent.

Use the **no** variant of this command to disable the time skew adjustment feature.

Syntax `2fa skew-adjust`
`no 2fa skew-adjust`

Default Time skew adjustment is disabled.

Mode Global Configuration

Usage notes The most likely cause of time skew (other than the clock being set wrong on the authenticator or authenticating device) is an incorrectly configured timezone.

When time skew adjustment is enabled, extra checking happens after an incorrect login. When an incorrect login occurs, the device will check a large number of codes either side of the current time. If it finds one that matches, it will record the **skew** of the code.

If the user enters 3 incorrect (but different) codes the device checks:

- were these codes entered in quick succession, i.e. with no more than one time-step gap between them, and
- did they all have the same skew value?

If these conditions are satisfied then the device will record this as an offset (time skew) and automatically adjust which codes it checks for that user in future.

The maximum number of codes to check is configurable with the [2fa max-skew](#) command. It defaults to 12.5 hours in either direction.

If a time skew value has been stored for a user this will be displayed (with a warning) in the [show 2fa user](#) command output.

Example To enable the time skew adjustment feature, use the following commands:

```
awplus# configure terminal
awplus(config)# 2fa skew-adjust
```

Related commands [2fa max-skew](#)
[2fa reset skew](#)
[service 2fa](#)
[show 2fa](#)

show 2fa user

show 2fa users

Command changes Version 5.5.2-1.1: command added

2fa totp-window-size

Overview Use this command to set the range of acceptable codes for time-based one-time password (TOTP) mode two-factor authentication (2FA). The window size is the number of codes checked, centered on the current time-step.

Use the **no** variant of this command to reset the window size to the default of 3.

Syntax `2fa totp-window-size <1-100>`
`no 2fa totp-window-size`

Parameter	Description
<code><1-100></code>	The number of codes valid for a given time-step, centered on the current time-step.

Default 3

Mode Global Configuration

Usage notes By default the TOTP window size is set to 3. This means that the code for the current, previous, and next 30 second time-step will be accepted. If the value is set to 1, only the code for the current time-step will be accepted. If it is increased, more time-steps each side of the current time-step will be accepted.

Example To set the window size to include codes for the two previous time-steps, the current, and the two time-steps following the current time (i.e. a total of 5 codes), use the commands:

```
awplus# configure terminal
awplus(config)# 2fa totp-window-size 5
```

To set the window size to the default value, use the commands:

```
awplus# configure terminal
awplus(config)# no 2fa totp-window-size
```

Related commands

- [2fa create user](#)
- [2fa delete user](#)
- [2fa hotp-window-size](#)
- [service 2fa](#)
- [show 2fa](#)
- [show 2fa user](#)
- [show 2fa users](#)

Command changes Version 5.5.2-1.1: command added

debug 2fa

Overview Use this command to turn on two-factor authentication (2FA) debug messaging. Use the **no** variant of this command to turn off 2FA debug messaging.

Syntax debug 2fa
no debug 2fa

Default Debug messaging is turned off.

Mode Privileged Exec

Example To turn on 2FA debug messaging, use the command:

```
awplus# debug 2fa
```

Related commands [service 2fa](#)
[show debugging 2fa](#)

Command changes Version 5.5.2-1.1: command added

service 2fa

Overview Use this command to enable two-factor authentication (2FA).

2FA is a method of strengthening security by requiring a second method of authentication. AlliedWare Plus supports 2FA on OpenVPN connections. It requires a software-based authenticator that implements the time-based one-time password (TOTP) or HMAC-based one-time password (HOTP) algorithms. These software authenticators (known as authenticator apps) are usually loaded on a mobile device. One well-known implementation of such an app is Google Authenticator.

For more information on configuring 2FA on OpenVPN, see the “Two-factor authentication” chapter in the [OpenVPN Feature Overview and Configuration Guide](#).

Use the **no** variant of this command to disable 2FA.

Syntax `service 2fa`
`no service 2fa`

Default Disabled

Mode Global Configuration

Usage notes Disabling the 2FA service stops the 2FA configuration from showing in the running configuration and prevents 2FA commands from working. You will not be able to view, create, or delete users with the service stopped. User data, however, is not deleted.

Additionally, the 2FA configuration is not reset until the device is rebooted. This means the configuration will be restored if the service is restarted before the device is rebooted.

If the OpenVPN method list is configured with 2FA and the 2FA service is not running then two-factor authentication will be skipped and a critical message will be logged when a user connects.

Example To enable the 2FA service, use the command:

```
awplus# service 2fa
```

To disable the 2FA service, use the command:

```
awplus# no service 2fa
```

Related commands [2fa create user](#)
[2fa delete user](#)
[show 2fa](#)
[show 2fa user](#)
[show 2fa users](#)

Command changes Version 5.5.2-1.1: command added

show 2fa

Overview Use this command to display information about your two-factor authentication configuration and the status of the 2FA service.

Syntax `show 2fa`

Mode Privileged Exec

Example To display information on your two-factor authentication configuration and status, use the command:

```
awplus# show 2fa
```

Output Figure 46-3: Example output from **show 2fa**

```
awplus#show 2fa

Two-Factor Authentication Information:

Settings:
  Disallow TOTP code reuse:      Yes
  Skip for users with no config: Yes
  TOTP window size:             3
  HOTP window size:             3
  Attempt Skew Adjustment:      No
  Label:                        awplus
  Debug:                        Enabled

Number of configured users:     2
```

Related commands

- [2fa create user](#)
- [2fa delete user](#)
- [service 2fa](#)
- [show 2fa user](#)

Command changes Version 5.5.2-1.1: command added

show 2fa user

Overview Use this command to display information about a two-factor authentication (2FA) user. You can optionally display the user's QR code.

Syntax `show 2fa user <user-name> [qr {ansi|utf8|link}]`

Parameter	Description
<user-name>	The name of the user you want to display.
qr	Display the QR code.
ansi	Display the QR code using ANSI block characters.
utf8	Display the QR code using a UTF-8 mosaic.
link	Display a hyperlink for a QR code generator. Opening the link in a browser will display a QR code. As the string is passed to an online QR code generator (at Google), it may be a security concern for some installations.

Mode Privileged Exec

Usage notes The QR code displays best in a color mode ANSI or UTF-8 terminal. If your terminal is insufficiently wide, or doesn't have the correct options enabled, you may not get a scannable QR code.

Example To display the 2FA information, and display a hyperlink for a QR code generator, for user 'test', use the command:

```
awplus# show 2fa user test qr link
```

Output Figure 46-4: Example output from **show 2fa user test qr link**

```
awplus#show 2fa user test qr link

Two-Factor Authentication information for user:

Username:      test
Secret:        RXB.....
Mode:          TOTP
OTP URL:       otpauth://totp/test@awplus?secret=RXB.....
Scratch codes:
    70344616
    91312817
    39931705
    89513481
    78647666

The following URL can be used to generate a QR code.
This results in the user key being sent to Google servers.
https://www.google.com/chart?chs=200x200&chld=M|0&cht=qr&chl=otpau
th://totp/test@awplus%3Fsecret%3DRXBH7KSCHOHWZPG6JFBRROGPSY
```

- Related commands**
- [2fa create user](#)
 - [2fa delete user](#)
 - [service 2fa](#)
 - [show 2fa](#)
 - [show 2fa users](#)

Command changes Version 5.5.2-1.1: command added

show 2fa users

Overview Use this command to display information about all the users configured with two-factor authentication (2FA) on the device.

Syntax `show 2fa users`

Mode Privileged Exec

Example To display the information for all configured 2FA users, use the command:

```
awplus# show 2fa users
```

Output Figure 46-5: Example output from **show 2fa users**

```
awplus#show 2fa users
Two-Factor Authentication users:
Username                               Last OTP Login
-----
test                                    -
test1                                    -
```

Related commands

- [2fa create user](#)
- [2fa delete user](#)
- [service 2fa](#)
- [show 2fa](#)
- [show 2fa user](#)

Command changes Version 5.5.2-1.1: command added

show debugging 2fa

Overview Use this command to display debugging information for two-factor authentication (2FA).

Syntax `show debugging 2fa`

Mode Privileged Exec

Example To display debugging information for two-factor authentication, use the command:

```
awplus# show debugging 2fa
```

Output Figure 46-6: Example output from **show 2fa**

```
awplus# show debugging 2fa
2FA Debugging Status: on
```

Related commands [debug 2fa](#)
[service 2fa](#)

Command changes Version 5.5.2-1.1: command added

47

Public Key Infrastructure and Crypto Commands

Introduction

Overview This chapter provides an alphabetical reference of commands used to configure the Public Key Infrastructure (PKI) capabilities on an AlliedWare Plus device. For more information about PKI, see the [Public Key Infrastructure \(PKI\) Feature Overview and Configuration Guide](#).

- Command List**
- [“crypto key generate rsa”](#) on page 2411
 - [“crypto key zeroize”](#) on page 2412
 - [“crypto pki authenticate”](#) on page 2413
 - [“crypto pki enroll”](#) on page 2414
 - [“crypto pki enroll user”](#) on page 2415
 - [“crypto pki export pem”](#) on page 2417
 - [“crypto pki export pkcs12”](#) on page 2418
 - [“crypto pki import pem”](#) on page 2420
 - [“crypto pki import pkcs12”](#) on page 2422
 - [“crypto pki trustpoint”](#) on page 2423
 - [“enrollment \(ca-trustpoint\)”](#) on page 2424
 - [“fingerprint \(ca-trustpoint\)”](#) on page 2425
 - [“no crypto pki certificate”](#) on page 2427
 - [“rsakeypair \(ca-trustpoint\)”](#) on page 2428
 - [“show crypto key mypubkey rsa”](#) on page 2429
 - [“show crypto pki certificates”](#) on page 2430
 - [“show crypto pki enrollment user”](#) on page 2432
 - [“show crypto pki trustpoint”](#) on page 2433
 - [“subject-name \(ca-trustpoint\)”](#) on page 2434

crypto key generate rsa

Overview Use this command to generate a cryptographic public/private key pair for the Rivest-Shamir-Adleman (RSA) encryption algorithm.

Syntax `crypto key generate rsa [label <keylabel>] [<1024-4096>]`

Parameter	Description
<keylabel>	The name of the key to be created. The name must start with an alphanumeric character, and may only contain alphanumeric characters, underscores, dashes, or periods. The maximum length of the name is 63 characters. If no label is specified the default value "server-default" is used.
<1024-4096>	The bit length for the key. If no bit length is specified the default of 2048 is used.

Mode Privileged Exec

Usage notes The generated key may be used for multiple server certificates in the system. A key is referenced by its label. A bit length between 1024 and 4096 bits may be specified. Larger bit lengths are more secure, but require more computation time. The specified key must not already exist.

Example To create a key with the label "example-server-key" and a bit length of 2048, use the commands:

```
awplus> enable  
awplus# crypto key generate rsa label example-server-key 2048
```

Related commands [crypto key zeroize](#)
[rsakeypair \(ca-trustpoint\)](#)
[show crypto key mypubkey rsa](#)

crypto key zeroize

Overview Use this command to delete one or all cryptographic public/private key pairs.

Syntax `crypto key zeroize rsa <keylabel>`
`crypto key zeroize all`

Parameter	Description
<code>rsa <keylabel></code>	Delete a single key pair for the Rivest-Shamir-Adleman (RSA) encryption algorithm.
<code>all</code>	Delete all keys.

Mode Privileged Exec

Usage notes Note that this command has the same effect as using the **delete** command (it deletes the file from Flash memory but does not overwrite it with zeros).

The specified key must exist but must not be in use for any existing server certificates.

A key may not be deleted if it is associated with the server certificate or server certificate signing request for an existing trustpoint. To remove a server certificate so that the key may be deleted, use the **no crypto pki enroll** command to de-enroll the server.

Example To delete an RSA key named "example-server-key", use the following command:

```
awplus# crypto key zeroize rsa example-server-key
```

Related commands [crypto key generate rsa](#)
[show crypto key mypubkey rsa](#)

Command changes Version 5.4.6-1.1: zeroize functionality added to x930 Series
Version 5.4.8-1.2: zeroize functionality added to x220, XS900MX, x550 Series
Version 5.4.8-2.1: zeroize functionality added to SBx908 GEN2, x950 Series

crypto pki authenticate

Overview Use this command to authenticate a trustpoint by generating or importing the root CA certificate. This must be done before the server can be enrolled to the trustpoint.

Syntax `crypto pki authenticate <trustpoint>`

Parameter	Description
<code><trustpoint></code>	The name of the trustpoint to be authenticated.

Mode Privileged Exec

Usage notes If the trustpoint's **enrollment** setting is "selfsigned", then this command causes a private key to be generated for the root CA, and a self-signed certificate to be generated based on that key.

If the trustpoint's **enrollment** setting is "terminal", then this command prompts the user to paste a certificate Privacy Enhanced Mail (PEM) file at the CLI terminal. If the certificate is a valid selfsigned CA certificate, then it will be stored as the trustpoint's root CA certificate.

The specified trustpoint must already exist, and its enrollment mode must have been defined.

Example To show the **enrollment** setting of a trustpoint named "example" and then generate a certificate from it, use the commands:

```
awplus> enable
awplus# configure terminal
awplus(config)# crypto pki trustpoint example
awplus(ca-trustpoint)# enrollment selfsigned
awplus(config)# exit
awplus# exit
awplus# crypto pki authenticate example
```

Related commands

- [crypto pki import pem](#)
- [crypto pki trustpoint](#)
- [enrollment \(ca-trustpoint\)](#)

crypto pki enroll

Overview Use this command to enroll the local server to the specified trustpoint.
Use the **no** variant of this command to de-enroll the server by removing its certificate

Syntax `crypto pki enroll <trustpoint>`
`no crypto pki enroll <trustpoint>`

Parameter	Description
<code><trustpoint></code>	The name of the trustpoint to be enrolled

Mode Privileged Exec

Usage notes For the local server, “enrollment” is the process of creating of a certificate for the server that has been signed by a CA associated with the trustpoint. The public portion of the RSA key pair specified using the `rsa` parameter for the trustpoint will be included in the server certificate.

If the trustpoint represents a locally self-signed certificate authority, then this command results in the direct generation of the server certificate, signed by the root CA for the trustpoint.

If the trustpoint represents an external certificate authority, then this command results in the generation of a Certificate Signing Request (CSR) file, which is displayed at the terminal in Privacy-Enhanced Mail (PEM) format, suitable for copying and pasting into a file or message. The CSR must be sent to the external CA for processing. When the CA replies with the signed certificate, that certificate should be imported using the `crypto pki import pem` command, to complete the enrollment process.

The specified trustpoint must already exist, and it must already be authenticated.

Example To enroll the local server with the trustpoint “example”, use the following commands:

```
awplus> enable
awplus# crypto pki enroll example
```

Related commands [crypto pki enroll user](#)
[crypto pki import pem](#)
[crypto pki trustpoint](#)
[enrollment \(ca-trustpoint\)](#)

crypto pki enroll user

Overview Use this command to enroll a single RADIUS user or all RADIUS users to the specified trustpoint.

Use the **no** variant of this command to remove the PKCS#12 file from the system. Note that the PKCS#12 files are generated in a temporary (volatile) file system, so a system restart also results in removal of all of the files.

Syntax

```
crypto pki enroll <trustpoint>
{user <username>|local-radius-all-users}

no crypto pki enroll <trustpoint>
{user <username>|local-radius-all-users}
```

Parameter	Description
<trustpoint>	The name of the trustpoint to which users are to be enrolled.
<username>	The name of the user to enroll to the trustpoint.

Mode Privileged Exec

Usage notes For RADIUS users, “enrollment” is the process of generating a private key and a corresponding client certificate for each user, with the certificate signed by the root CA for the trustpoint. The resulting certificates may be exported to client devices, for use with PEAP or EAP-TLS authentication with the local RADIUS server.

The specified trustpoint must represent a locally self-signed certificate authority.

The private key and certificate are packaged into a PKCS#12-formatted file, suitable for export using the **crypto pki export pkcs12** command. The private key is encrypted for security, with a passphrase that is entered at the command line. The passphrase is required when the PKCS#12 file is imported on the client system. The passphrase is not stored anywhere on the device, so users are responsible for remembering it until the export-import process is complete.

If **local-radius-all-users** is specified instead of an individual user, then keys and certificates for all RADIUS users will be generated at once. All the keys will be encrypted using the same passphrase.

The specified trustpoint must already exist, it must represent a locally self-signed CA, and it must already have been authenticated.

Example To enroll the user “example-user” with the trustpoint “example”, use the following commands:

```
awplus> enable
awplus# crypto pki enroll example user example-user
```

To enroll all local RADIUS users with the trustpoint "example", use the following commands:

```
awplus> enable
```

```
awplus# crypto pki enroll example local-radius-all-users
```

Related commands

- [crypto pki export pkcs12](#)
- [crypto pki trustpoint](#)

crypto pki export pem

Overview Use this command to export the root CA certificate for the given trustpoint to a file in Privacy-Enhanced Mail (PEM) format. The file may be transferred to the specified destination URL, or displayed at the terminal.

Syntax `crypto pki export <trustpoint> pem [terminal|<url>]`

Parameter	Description
<trustpoint>	The name of the trustpoint for which the root CA certificate is to be exported.
terminal	Display the PEM file to the terminal.
<url>	Transfer the PEM file to the specified URL.

Default The PEM will be displayed to the terminal by default.

Mode Privileged Exec

Usage notes The specified trustpoint must already exist, and it must already be authenticated.

Example To display the PEM file for the trustpoint "example" to the terminal, use the following commands:

```
awplus> enable
awplus# crypto pki export example pem terminal
```

To export the PEM file "example.pem" for the trustpoint "example" to the URL "tftp://server_a/", use the following commands:

```
awplus> enable
awplus# crypto pki export example pem
tftp://server_a/example.pem
```

Related commands

- [crypto pki authenticate](#)
- [crypto pki import pem](#)
- [crypto pki trustpoint](#)

crypto pki export pkcs12

Overview Use this command to export a certificate and private key for an entity in a trustpoint to a file in PKCS#12 format at the specified URL. The private key is encrypted with a passphrase for security.

Syntax `crypto pki export <trustpoint> pkcs12 {ca|server|<username>} <url>`

Parameter	Description
<trustpoint>	The name of the trustpoint for which the certificate and key are to be exported.
ca	If this option is specified, the command exports the root CA certificate and corresponding key.
server	If this option is specified, the command exports the server certificate and corresponding key.
<username>	If a RADIUS username is specified, the command exports the PKCS#12 file that was previously generated using the <code>crypto pki enroll user</code> command. To avoid ambiguity with keywords, the username may be prefixed by the string "user:".
<url>	The destination URL for the PKCS#12 file. The format of the URL is the same as any valid destination for a file copy command.

Mode Privileged Exec

Usage notes If the **ca** option is specified, this command exports the root CA certificate and the corresponding private key, if the trustpoint has been authenticated as a locally selfsigned CA. (If the trustpoint represents an external CA, then there is no private key on the system corresponding to the root CA certificate. Use the **crypto pki export pem** file to export the certificate by itself.) The command prompts for a passphrase to encrypt the private key.

If the **server** option is specified, this command exports the server certificate and the corresponding private key, if the server has been enrolled to the trustpoint. The command prompts for a passphrase to encrypt the private key.

If a RADIUS username is specified, this command exports the PKCS#12 file that was generated using the **crypto pki enroll user** command. (The key within the file was already encrypted as part of the user enrollment process.)

In the event that there is a RADIUS user named "ca" or "server", enter "user:ca" or "user:server" as the username.

The key and certificate must already exist.

Example To export the PKCS#12 file "example.pk12" for the trustpoint "example" to the URL "tftp://backup/", use the following commands:

```
awplus> enable  
awplus# crypto pki export example pkcs12 ca  
tftp://backup/example.pk12
```

Related commands

- crypto pki enroll user
- crypto pki export pem
- crypto pki import pkcs12

crypto pki import pem

Overview This command imports a certificate for the given trustpoint from a file in Privacy-Enhanced Mail (PEM) format. The file may be transferred from the specified destination URL, or entered at the terminal.

Syntax `crypto pki import <trustpoint> pem [terminal|<url>]`

Parameter	Description
<trustpoint>	The name of the trustpoint for which the root CA certificate is to be imported.
terminal	Optional parameter, If specified, the command prompts the user to enter (or paste) the PEM file at the terminal. If parameter is specified terminal is assumed by default.
<url>	Optional parameter, If specified, the PEM file is transferred from the specified URL

Default The PEM will be imported from the terminal by default.

Mode Privileged Exec

Usage notes The command is generally used for trustpoints representing external certificate authorities. It accepts root CA certificates, intermediate CA certificates, and server certificates. The system automatically detects the certificate type upon import.

Using this command to import root CA certificates at the terminal is identical to the functionality provided by the `crypto pki authenticate` command, for external certificate authorities. The imported certificate is validated to ensure it is a proper CA certificate.

Intermediate CA certificates are validated to ensure they are proper CA certificates, and that the issuer chain ends in a root CA certificate already installed for the trustpoint. If there is no root CA certificate for the trustpoint (i.e., if the trustpoint is unauthenticated) then intermediate CA certificates may not be imported.

Server certificates are validated to ensure that the issuer chain ends in a root CA certificate already installed for the trustpoint. If there is no root CA certificate for the trustpoint (i.e., if the trustpoint is unauthenticated) then server certificates may not be imported.

The specified trustpoint must already exist. If the imported certificate is self-signed, then no certificates may exist for the trustpoint. Otherwise, the issuer's certificate must already be present for the trustpoint.

Example To import the PEM file for the trustpoint "example" from the terminal, use the following commands:

```
awplus> enable
awplus# crypto pki import example pem
```

To import the PEM file for the trustpoint "example" from the URL "tftp://server_a/", use the following commands:

```
awplus> enable  
awplus# crypto pki import example pem  
tftp://server_a/example.pem
```

Related commands

- [crypto pki authenticate](#)
- [crypto pki export pem](#)
- [crypto pki trustpoint](#)

crypto pki import pkcs12

Overview This command imports a certificate and private key for an entity in a trustpoint from a file in PKCS#12 format at the specified URL. The command prompts for a passphrase to decrypt the private key within the file.

Syntax `crypto pki import <trustpoint> pkcs12 {ca|server} <url>`

Parameter	Description
<trustpoint>	The name of the trustpoint for which the certificate and key are to be imported.
ca	If this option is specified, the command imports the root CA certificate and corresponding key.
server	If this option is specified, the command imports the server certificate and corresponding key.
<url>	The source URL for the PKCS#12 file. The format of the URL is the same as any valid destination for a file copy command.

Mode Privileged Exec

Usage notes If the **ca** option is specified, this command imports the root CA certificate and the corresponding private key. This is only valid if the root CA certificate does not already exist for the trustpoint (i.e., if the trustpoint is unauthenticated).

If the **server** option is specified, this command imports the server certificate and the corresponding private key. The imported private key is given a new unique label of the form "localN", where N is a non-negative integer. This operation is only valid if the server certificate does not already exist for the trustpoint (i.e., if the server is not enrolled to the trustpoint).

PKCS#12 files for RADIUS users may not be imported with this command. (There is no value in doing so, as the files are not needed on the local system.)

The specified trustpoint must already exist. The key and certificate must not already exist.

Example To import the PKCS#12 file "example.pk12" for the trustpoint "example" to the URL "tftp://backup/", use the following commands:

```
awplus> enable
awplus# crypto pki import example pkcs12 ca
tftp://backup/example.pk12
```

Related commands [crypto pki export pkcs12](#)
[crypto pki import pem](#)

crypto pki trustpoint

Overview Use this command to declare the named trustpoint and enter trustpoint configuration mode.

Use the **no** variant of this command to destroy the trustpoint.

Syntax `crypto pki trustpoint <trustpoint>`
`no crypto pki trustpoint <trustpoint>`

Parameter	Description
<code><trustpoint></code>	The name of the trustpoint. The name must start with an alphanumeric character, and may only contain alphanumeric characters, underscores, dashes, or periods. The maximum length of the name is 63 characters.

Mode Global Configuration

Usage notes If the trustpoint did not previously exist, it is created as a new trustpoint. The trustpoint will be empty (unauthenticated) unless the name "local" is selected, in which case the system will automatically authenticate the trustpoint as a local self-signed certificate authority.

The **no** variant of this command destroys the trustpoint by removing all CA and server certificates associated with the trustpoint, as well as the private key associated with the root certificate (if the root certificate was locally self-signed). This is a destructive and irreversible operation, so this command should be used with caution.

Example To configure a trustpoint named "example", use the following commands:

```
awplus> enable
awplus# configure terminal
awplus(config)# crypto pki trustpoint example
```

Related commands [show crypto pki certificates](#)
[show crypto pki trustpoint](#)

Command changes Version 5.4.6-1.1: command added to x930 Series
Version 5.4.8-1: command added to x220, XS900MX, x550 Series
Version 5.4.8-2.1: command added to SBx908 GEN2, x950 Series

enrollment (ca-trustpoint)

Overview Use this command to declare how certificates will be added to the system for the current trustpoint.

Syntax `enrollment {selfsigned|terminal}`

Parameter	Description
<code>selfsigned</code>	Sets the enrollment mode for the current trustpoint to selfsigned.
<code>terminal</code>	Sets the enrollment mode for the current trustpoint to terminal.

Mode Trustpoint Configuration

Usage notes If the enrollment is set to **selfsigned**, then the system will generate a root CA certificate and its associated key when the **crypto pki authenticate** command is issued. It will generate a server certificate (signed by the root CA certificate) when the **crypto pki enroll** command is issued.

If the enrollment is set to **terminal**, then the system will prompt the user to paste the root CA certificate Privacy Enhanced Mail (PEM) file at the terminal, when the **crypto pki authenticate** command is issued. It will create a Certificate Signing Request (CSR) file for the local server when the **crypto pki enroll** command is issued. The server certificate received from the external CA should be imported using the **crypto pki import pem** command.

The trustpoint named "local" may only use the **selfsigned** enrollment setting.

If no enrollment mode is specified, the **crypto pki authenticate** command will fail for the trustpoint.

Example To configure the trustpoint named "example" and set its enrollment to **selfsigned**, use the following commands:

```
awplus> enable
awplus# configure terminal
awplus(config)# crypto pki trustpoint example
awplus(ca-trustpoint)# enrollment selfsigned
```

Related commands [crypto pki enroll](#)

fingerprint (ca-trustpoint)

Overview Use this command to declare that certificates with the specified fingerprint should be automatically accepted, when importing certificates from an external certificate authority. This can affect the behavior of the **crypto pki authenticate** and **crypto pki import pem** commands.

Use the **no** variant of this command to remove the specified fingerprint from the pre-accepted list.

Syntax fingerprint <word>
no fingerprint <word>

Parameter	Description
<word>	The fingerprint as a series of 40 hexadecimal characters, optionally separated into multiple character strings.

Default By default, no fingerprints are pre-accepted for the trustpoint.

Mode Trustpoint Configuration

Usage notes Specifying a fingerprint adds it to a list of pre-accepted fingerprints for the trustpoint. When a certificate is imported, if it matches any of the pre-accepted values, then it will be saved in the system automatically. If the imported certificate's fingerprint does not match any pre-accepted value, then the user will be prompted to verify the certificate contents and fingerprint visually.

This command is useful when certificates from an external certificate authority are being transmitted over an insecure channel. If the certificate fingerprint is delivered via a separate messaging channel, then pre-entering the fingerprint value via cut-and-paste may be less errorprone than attempting to verify the fingerprint value visually.

The fingerprint is a series of 40 hexadecimal characters. It may be entered as a continuous string, or as a series of up to multiple strings separated by spaces. The input format is flexible because different certificate authorities may provide the fingerprint string in different formats.

Example To configure a fingerprint "5A81D34C 759CC4DA CFCA9F65 0303AD83 410B03AF" for the trustpoint named "example", use the following commands:

```
awplus> enable
awplus# configure terminal
awplus(config)# crypto pki trustpoint example
awplus(ca-trustpoint)# fingerprint 5A81D34C 759CC4DA CFCA9F65
0303AD83 410B03AF
```

Related commands [crypto pki authenticate](#)

crypto pki import pem

no crypto pki certificate

Overview Use this command to delete a certificate with the specified fingerprint from the specified trustpoint.

Syntax `no crypto pki certificate <trustpoint> <word>`

Parameter	Description
<code><trustpoint></code>	The name of the trustpoint.
<code><word></code>	The fingerprint as a series of 40 hexadecimal characters, optionally separated into multiple character strings.

Default By default, no fingerprints are pre-accepted for the trustpoint.

Mode Privileged Exec

Usage notes The fingerprint can be found in the output of the **show crypto pki certificates** command. If there are dependent certificates in the trustpoint (i.e., if other certificates were signed by the specified certificate), the command will be rejected. If the specified certificate is the root CA certificate and the trustpoint represents a locally selfsigned CA, then the corresponding private key is also deleted from the system. Deleting the root CA certificate effectively resets the trustpoint to an unauthenticated state.

Example To delete a certificate with the fingerprint "594EDEF9 C7C4308C 36D408E0 77E784F0 A59E8792" from the trustpoint "example", use the following commands:

```
awplus> enable
awplus# no crypto pki certificate example
594EDEF9 C7C4308C 36D408E0 77E784F0 A59E8792
```

Related commands [no crypto pki trustpoint](#)
[show crypto pki certificates](#)

rsakeypair (ca-trustpoint)

Overview Use this command to declare which RSA key pair should be used to enroll the local server with the trustpoint. Note that this defines the key pair used with the server certificate, not the key pair used with the root CA certificate.

Use the **no** variant of this command to restore the default value, "server-default".

Syntax `rsakeypair <keylabel> [<1024-4096>]`
`no rsakeypair`

Parameter	Description
<code><keylabel></code>	The key to be used with the server certificate for this trustpoint. The name must start with an alphanumeric character, and may only contain alphanumeric characters, underscores, dashes, or periods. The maximum length of the name is 63 characters.
<code><1024-4096></code>	The bit length for the key, to be used if the key is implicitly generated during server enrollment.

Default The default value for **keylabel** is "server-default".
The default value for the key bit length is 2048.

Mode Trustpoint Configuration

Usage notes If the label specified does not refer to an existing key created by the **crypto key generate rsa** command, the key will be implicitly generated when the **crypto pki enroll** command is issued to generate the server certificate or the server certificate signing request. The optional numeric parameter defines the bit length for the key, and is only applicable for keys that are implicitly created during enrollment.

This command does not affect server certificates or server certificate signing requests that have already been generated. The trustpoint's server certificate is set to use whatever key pair was specified for the trustpoint at the time the **crypto pki enroll** command is issued.

The default key pair is "server-default". The default bit length is 2048 bits.

Example To configure trustpoint "example" to use the key pair "example-server-key" with a bit length of 2048, use the following commands:

```
awplus> enable
awplus# configure terminal
awplus(config)# crypto pki trustpoint example
awplus(ca-trustpoint)# rsakeypair example-server-key 2048
```

Related commands [crypto key generate rsa](#)

show crypto key mypubkey rsa

Overview Use this command to display information about the specified Rivest-Shamir-Adleman encryption key.

Syntax `show crypto key mypubkey rsa [<keylabel>]`

Parameter	Description
<keylabel>	The name of the key to be shown, if specified.

Default By default, all keys will be shown.

Mode Privileged Exec

Usage notes If no key label is specified, information about all keys is shown. The command displays the bit length of the key, a key fingerprint (a hash of the key contents to help uniquely identify a key), and a list of trustpoints in which the server certificate is using the key.

The specified keys must exist.

Example To show all keys, use the following commands:

```
awplus> enable
awplus# show crypto key mypubkey rsa
```

Output Figure 47-1: Example output from **show crypto key mypubkey rsa**

```
awplus#show crypto key mypubkey rsa
-----
RSA Key Pair "example-server-key":
  Key size      : 2048 bits
  Fingerprint  : 1A605D73 C2274CB7 853886B3 1C802FC6 7CDE45FB
  Trustpoints   : example
-----
RSA Key Pair "server-default":
  Key size      : 2048 bits
  Fingerprint  : 34AC4D2D 5249A168 29D426A3 434FFC59 C4A19901
  Trustpoints   : local
```

Related commands [crypto key generate rsa](#)

show crypto pki certificates

Overview Use this command to display information about existing certificates for the specified trustpoint.

Syntax `show crypto pki certificates [<trustpoint>]`

Parameter	Description
<code><trustpoint></code>	The trustpoint for which the certificates are to be shown.

Default By default, the certificates for all trustpoints are shown.

Mode Privileged Exec

Usage notes If no trustpoint is specified, certificates for all trustpoints are shown. The command displays the certificates organized into certificate chains. It starts with the server certificate and then displays its issuer, and continues up the issuer chain until the root CA certificate is reached.

For each certificate, the command displays the certificate type, the subject's distinguished name (the entity identified by the certificate), the issuer's distinguished name (the entity that signed the certificate), the validity dates for the certificate, and the fingerprint of the certificate. The fingerprint is a cryptographic hash of the certificate contents that uniquely identifies the certificate.

The specified trustpoints must already exist.

Example To show the certificates for the trustpoint "example", use the following command:

```
awplus> enable
awplus# show crypto pki certificates example
```

Output Figure 47-2: Example output from **show crypto pki certificates**

```
awplus>enable
awplus#show crypto pki certificates example
-----
Trustpoint "example" Certificate Chain
-----
Server certificate
  Subject      : /O=local/CN=local.loc.lc
  Issuer       : /C=NZ/CN=local_Signing_CA
  Valid From   : Nov 11 15:35:21 2015 GMT
  Valid To     : Aug 31 15:35:21 2018 GMT
  Fingerprint  : 5A81D34C 759CC4DA CFCA9F65 0303AD83 410B03AF
Intermediate CA certificate
  Subject      : /C=NZ/CN=example_Signing_CA
  Issuer       : /C=NZ/CN=example_Root_CA
  Valid From   : Sep 3 18:45:01 2015 GMT
  Valid To     : Oct 10 18:45:01 2020 GMT
  Fingerprint  : AE2D5850 9867D258 ABBEE95E 2E0E3D81 60714920
Imported root certificate
  Subject      : /C=NZ/CN=example_Root_CA
  Issuer       : /C=NZ/CN=example_Root_CA
  Valid From   : Jul 23 18:12:10 2015 GMT
  Valid To     : May 12 18:12:10 2025 GMT
  Fingerprint  : 594EDEF9 C7C4308C 36D408E0 77E784F0 A59E8792
```

Related commands [crypto pki trustpoint](#)

show crypto pki enrollment user

Overview Use this command to display a list of trustpoints for which RADIUS user enrollments have been performed, using the **crypto pki enroll user** command. This indicates that PKCS#12 files for the user are available for export for the given trustpoints, using the **crypto pki export pkcs12** command.

Syntax `crypto pki enrollment user <username>`

Parameter	Description
<code><username></code>	The user for which enrollments are to be shown.

Mode Privileged Exec

Example To show the list of trustpoints to which user "exampleuser1" is enrolled, use the following commands:

```
awplus> enable
awplus(config)# show crypto pki enrollment user exampleuser1
```

Output Figure 47-3: Example output from **show crypto pki enrollment user**

```
awplus> enable
awplus# show crypto pki enrollment user exampleuser1
User "exampleuser1" is enrolled to the following trustpoints:
local,example
```

Related commands [crypto pki enroll user](#)
[crypto pki export pkcs12](#)

show crypto pki trustpoint

Overview Use this command to display information about the specified trustpoint.

Syntax `show crypto pki trustpoint [<trustpoint>]`

Parameter	Description
<code><trustpoint></code>	The name of the trustpoint to be shown

Default By default, all trustpoints are shown.

Mode Privileged Exec

Usage notes If no trustpoint is specified, information about all trustpoints is shown. The command displays the authentication status of the trustpoint, the fingerprint of the root CA certificate (if it exists), the enrollment status of the local server with the trustpoint, a list of any applications that are configured to use the trustpoint, and the trustpoint parameters that were configured from trustpoint-configuration mode.

The specified trustpoints must already exist.

Example To show the details of the trustpoint "example", use the following commands:

```
awplus> enable
awplus# show crypto pki trustpoint example
```

Output Figure 47-4: Example output from **show crypto pki trustpoint**

```
awplus> enable
awplus# show crypto pki trustpoint example
-----
Trustpoint "example"
  Type           : Self-signed certificate authority
  Root Certificate: 50C1856B EEC7555A 0F3A61F6 690D9463 67DF74D1
  Local Server   : The server is enrolled to this trustpoint.
  Server Key     : example-server-key
  Applications   : RADIUS

Authentication and Enrollment Parameters:
  Enrollment     : selfsigned
  RSA Key Pair   : example-server-key (2048 bits)
-----
```

Related commands [crypto pki trustpoint](#)
[show crypto pki certificates](#)

subject-name (ca-trustpoint)

Overview Use this command to specify the distinguished name string that should be used for the subject field in the server certificate, when enrolling the server (generating the server certificate or server certificate signing request).

Syntax `subject-name <word>`

Parameter	Description
<code><word></code>	Specify the subject name as a distinguished name string. Complex strings (e.g., strings containing spaces) should be surrounded with double-quote characters.

Default If no subject name is specified for the trustpoint, then the system automatically builds a name of the form `/O=AlliedWare Plus/CN=xxxx.yyyy.zzz`, where `xxxx` is the hostname of the system and `yyy.zzz` is the default search domain for the system.

Mode Trustpoint Configuration

Usage notes The subject name is specified as a variable number of fields, where each field begins with a forward-slash character (`/`). Each field is of the form `XX=value`, where `XX` is the abbreviation of the node type in the tree.

Common values include:

- `"C"` (country),
- `"ST"` (state),
- `"L"` (locality),
- `"O"` (organization),
- `"OU"` (organizational unit), and
- `"CN"` (common name).

Of these fields, `"CN"` is usually the most important.

NOTE: For a server certificate, many applications require that the network name of the server matches the common name in the server's certificate.

Example To configure the trustpoint named "example" and set its subject name, use the following commands:

```
awplus> enable
awplus# configure terminal
awplus(config)# crypto pki trustpoint example
awplus(ca-trustpoint)# subject-name "/O=My
Company/CN=192.168.1.1
```

**Related
commands** [crypto pki enroll](#)

48

TACACS+ Commands

Introduction

Overview This chapter provides an alphabetical reference for commands used to configure the device to use TACACS+ servers. For more information about TACACS+, see the [TACACS+ Feature Overview and Configuration Guide](#).

- Command List**
- [“aaa authorization commands”](#) on page 2437
 - [“aaa authorization config-commands”](#) on page 2439
 - [“authorization commands”](#) on page 2440
 - [“ip tacacs source-interface”](#) on page 2442
 - [“show tacacs+”](#) on page 2443
 - [“tacacs-server host”](#) on page 2445
 - [“tacacs-server key”](#) on page 2447
 - [“tacacs-server timeout”](#) on page 2448

aaa authorization commands

Overview This command configures a method list for commands authorization that can be applied to console or VTY lines. When command authorization is enabled for a privilege level, only authorized users can executed commands in that privilege level.

Use the **no** variant of this command to remove a named method list or disable the default method list for a privilege level.

Syntax

```
aaa authorization commands <privilege-level>
{default|<list-name>} group tacacs+ [none]

no aaa authorization commands <privilege-level>
{default|<list-name>}
```

Parameter	Description
<privilege-level>	The privilege level of the set of commands the method list will be applied to. AlliedWare Plus defines three sets of commands, that are indexed by a level value: Level = 1: All commands that can be accessed by a user with privilege level between 1 and 6 inclusive Level = 7: All commands that can be accessed by a user with privilege level between 7 and 14 inclusive Level = 15: All commands that can be accessed by a user with privilege level 15
group	Specify the server group where authorization messages are sent. Only the <code>tacacs+</code> group is available for this command.
tacacs+	Use all TACACS+ servers configured by the <code>tacacs-server host</code> command.
default	Configure the default authorization commands method list.
<list-name>	Configure a named authorization commands method list
none	If specified, this provides a local fallback to command authorization so that if authorization servers become unavailable then the device will accept all commands normally allowed for the privilege level of the user.

Mode Global Configuration

Usage notes TACACS+ command authorization provides centralized control of the commands available to a user of an AlliedWare Plus device. Once enabled:

- The command string and username are encrypted and sent to the first available configured TACACS+ server (the first server configured) for authorization.

- The TACACS+ server decides if the user is authorized to execute the command and returns the decision to the AlliedWare Plus device.
- Depending on this decision the device will then either execute the command or notify the user that authorization has failed.

If multiple TACACS+ servers are configured, and the first server is unreachable or does not respond, the other servers will be queried, in turn, for an authorization decision. If all servers are unreachable and a local fallback has been configured, with the **none** parameter, then commands are authorized based on the user's privilege level; the same behavior as if command authorization had not been configured. If, however, the local fallback is not configured and all servers become unreachable then all commands except **logout**, **exit**, and **quit** will be denied.

The **default** method list is defined with a local fallback unless configured differently using this command.

Example To configure a commands authorization method list, named TAC15, using all TACACS+ servers to authorize commands for privilege level 15, with a local fallback, use the following commands:

```
awplus# configure terminal
awplus(config)# aaa authorization commands 15 TAC15 group
tacacs+ none
```

To configure the default method list to authorize commands for privilege level 7, with no local fallback, use the following commands:

```
awplus# configure terminal
awplus(config)# aaa authorization commands 7 default group
tacacs+
```

To remove the authorization method list TAC15, use the following commands:

```
awplus# configure terminal
awplus(config)# no aaa authorization commands 15 TAC15
```

Related commands [aaa authorization config-commands](#)
[authorization commands](#)
[tacacs-server host](#)

Command changes Version 5.4.6-2.1: command added

aaa authorization config-commands

Overview Use this command to enable command authorization on configuration mode commands. By default, command authorization applies to commands in exec mode only.

Use the **no** variant of this command to disable command authorization on configuration mode commands.

Syntax `aaa authorization config-commands`
`no aaa authorization config-commands`

Default By default, command authorization is disabled on configuration mode commands.

Mode Global Configuration

Usage notes If authorization of configuration mode commands is not enabled then all configuration commands are accepted by default, including command authorization commands.

NOTE: *Authorization of configuration commands is required for a secure TACACS+ command authorization configuration as it prevents the feature from being disabled to gain access to unauthorized exec mode commands.*

Example To enable command authorization for configuration mode commands, use the commands:

```
awplus# configure terminal
awplus(config)# aaa authorization config-commands
```

To disable command authorization for configuration mode commands, use the commands:

```
awplus# configure terminal
awplus(config)# no aaa authorization config-commands
```

Related commands [aaa authorization commands](#)
[authorization commands](#)
[tacacs-server host](#)

Command changes Version 5.4.6-2.1: command added

authorization commands

Overview This command applies a command authorization method list, defined using the [aaa authorization commands](#) command, to console and VTY lines.

Use the **no** variant of this command to reset the command authorization configuration on the console and VTY lines.

Syntax `authorization commands <privilege-level> {default|<list-name>}`
`no authorization commands <privilege-level>`

Parameter	Description
<code><privilege-level></code>	The privilege level of the set of commands the method list will be applied to. AlliedWare Plus defines three sets of commands, that are indexed by a level value: Level = 1: All commands that can be accessed by a user with privilege level between 1 and 6 inclusive Level = 7: All commands that can be accessed by a user with privilege level between 7 and 14 inclusive Level = 15: All commands that can be accessed by a user with privilege level 15
<code>default</code>	Configure the default authorization commands method list.
<code><list-name></code>	Configure a named authorization commands method list

Default The **default** method list is applied to each console and VTY line by default.

Mode Line Configuration

Usage notes If the specified method list does not exist users will not be able to execute any commands in the specified method list on the specified VTY lines.

Example To apply the TAC15 command authorization method list with privilege level 15 to VTY lines 0 to 5, use the following commands:

```
awplus# configure terminal
awplus(config)# line vty 0 5
awplus(config-line)# authorization commands 15 TAC15
```

To reset the command authorization configuration with privilege level 15 on VTY lines 0 to 5, use the following commands:

```
awplus# configure terminal
awplus(config)# line vty 0 5
awplus(config-line)# no authorization commands 15
```

Related commands [aaa authorization commands](#)

aaa authorization config-commands

tacacs-server host

Command changes Version 5.4.6-2.1: command added

ip tacacs source-interface

Overview This command sets the source interface, or IP address, to use for all TACACS+ packets sent from the device. By default, TACACS+ packets use the source IP address of the egress interface.

Use the **no** variant of this command to remove the source interface configuration and use the source IP address of the egress interface.

Syntax `ip tacacs source-interface {<interface>|<ip-address>}`
`no ip tacacs source-interface`

Parameter	Description
<code><interface></code>	Interface name.
<code><ip-address></code>	IP address in the dotted decimal format A.B.C.D.

Default The source IP address of outgoing TACACS+ packets default to the IP address of the egress interface.

Mode Global Configuration

Usage notes Setting the source interface ensures that all TACACS+ packets sent from the device will have the same source IP address. Once configured this affects all TACACS+ packets, namely accounting, authentication, and authorization.

If the specified interface is down or there is no IP address on the interface, then the source IP address of outgoing TACACS+ packets will default to the IP address of the egress interface.

Example To configure all outgoing TACACS+ packets to use the IP address of the loop-back "lo" interface as the source IP address, use the following commands:

```
awplus# configure terminal
awplus(config)# ip tacacs source-interface lo
```

To reset the source interface configuration for all TACACS+ packets, use the following commands:

```
awplus# configure terminal
awplus(config)# no ip tacacs source-interface
```

Related commands [tacacs-server host](#)
[show tacacs+](#)

Command changes Version 5.4.6-2.1: command added

show tacacs+

Overview This command displays the current TACACS+ server configuration and status.

Syntax show tacacs+

Mode User Exec and Privileged Exec

Example To display the current status of TACACS+ servers, use the command:

```
awplus# show tacacs+
```

Output Figure 48-1: Example output from the **show tacacs+** command

```
TACACS+ Global Configuration
  Source Interface      : not configured
  Timeout              : 5 sec

Server Host/          Server
IP Address            Status
-----
192.168.1.10         Alive
192.168.1.11         Unknown
```

Table 1: Parameters in the output of the **show tacacs+** command

Output Parameter	Meaning	
Source Interface	IP address of source interface if set with <code>ip tacacs source-interface</code> .	
Timeout	A time interval in seconds.	
Server Host/IP Address	TACACS+ server hostname or IP address.	
Server Status	The status of the authentication port.	
	Alive	The server is alive.
	Dead	The server has timed out.
	Error	The server is not responding or there is an error in the key string entered.
	Unknown	The server is never used or the status is unknown.
	Unreachable	The server is unreachable.
Unresolved	The server name can not be resolved.	

Command changes Version 5.4.6-2.1: **Source Interface** parameter added

tacacs-server host

Overview Use this command to specify a remote TACACS+ server host for authentication, authorization and accounting, and to set the shared secret key to use with the TACACS+ server. The parameters specified with this command override the corresponding global parameters for TACACS+ servers.

Use the **no** variant of this command to remove the specified server host as a TACACS+ authentication and authorization server.

Syntax `tacacs-server host {<host-name>|<ip-address>} [key [8] <key-string>]`

`no tacacs-server host {<host-name>|<ip-address>}`

Syntax (VRF-lite) `tacacs-server host {<host-name>|<ip-address>} [vrf <vrf-name>] [key [8] <key-string>]`

`no tacacs-server host {<host-name>|<ip-address>} [vrf <vrf-name>]`

Parameter	Description
<code><host-name></code>	Server host name. The DNS name of the TACACS+ server host.
<code><ip-address></code>	The IP address of the TACACS+ server host, in dotted decimal notation A.B.C.D.
<code>vrf <vrf-name></code>	The name of a VRF instance. Use this to specify the VRF that the TACACS+ server is accessible by. Servers are uniquely identified by their address and VRF, so multiple servers can have the same address or host-name as long as the VRF is different. The default is the global VRF.
<code>key</code>	Set shared secret key with TACACS+ servers.
<code>8</code>	Specifies that you are entering a password as a string that has already been encrypted instead of entering a plain text password. The running config displays the new password as an encrypted string even if password encryption is turned off.
<code><key-string></code>	Shared key string applied, a value in the range 1 to 64 characters. Specifies the shared secret authentication or encryption key for all TACACS+ communications between this device and the TACACS+ server. This key must match the encryption used on the TACACS+ server. This setting overrides the global setting of the tacacs-server key command. If no key value is specified, the global value is used.

Default No TACACS+ server is configured by default.

Mode Global Configuration

Usage A TACACS+ server host cannot be configured multiple times like a RADIUS server.

As many as four TACACS+ servers can be configured and consulted for login authentication, enable password authentication and accounting. The first server configured is regarded as the primary server and if the primary server fails then the backup servers are consulted in turn. A backup server is consulted if the primary server fails, not if a login authentication attempt is rejected. The reasons a server would fail are:

- it is not network reachable
- it is not currently TACACS+ capable
- it cannot communicate with the switch properly due to the switch and the server having different secret keys

Examples To add the server tac1.company.com as the TACACS+ server host, use the following commands:

```
awplus# configure terminal
awplus(config)# tacacs-server host tac1.company.com
```

To set the secret key to 'secret' on the TACACS+ server 192.168.1.1, use the following commands:

```
awplus# configure terminal
awplus(config)# tacacs-server host 192.168.1.1 key secret
```

To remove the TACACS+ server tac1.company.com, use the following commands:

```
awplus# configure terminal
awplus(config)# no tacacs-server host tac1.company.com
```

Examples (VRF-lite) To add the server tac1.company.com as the TACACS+ server host in the VRF named 'red', use the following commands:

```
awplus# configure terminal
awplus(config)# tacacs-server host tac1.company.com vrf red
```

To remove the TACACS+ server 192.168.1.1 from the VRF named 'red', use the following commands:

```
awplus# configure terminal
awplus(config)# no tacacs-server host 192.168.1.1 vrf red
```

Related commands

- [aaa accounting commands](#)
- [aaa authentication login](#)
- [tacacs-server key](#)
- [tacacs-server timeout](#)
- [show tacacs+](#)

Command changes Version 5.5.2-1.1: **vrf** parameter added for products that support VRF

tacacs-server key

Overview This command sets a global secret key for TACACS+ authentication, authorization and accounting. The shared secret text string is used for TACACS+ communications between the switch and all TACACS+ servers.

Note that if no secret key is explicitly specified for a TACACS+ server with the [tacacs-server host](#) command, the global secret key will be used for the shared secret for the server.

Use the **no** variant of this command to remove the global secret key.

Syntax `tacacs-server key [8] <key-string>`
`no tacacs-server key`

Parameter	Description
8	Specifies a string in an encrypted format instead of plain text. The running config will display the new password as an encrypted string even if password encryption is turned off.
<key-string>	Shared key string applied, a value in the range 1 to 64 characters. Specifies the shared secret authentication or encryption key for all TACACS+ communications between this device and all TACACS+ servers. This key must match the encryption used on the TACACS+ server.

Mode Global Configuration

Usage notes Use this command to set the global secret key shared between this client and its TACACS+ servers. If no secret key is specified for a particular TACACS+ server using the [tacacs-server host](#) command, this global key is used.

Examples To set the global secret key to `secret` for TACACS+ server, use the following commands:

```
awplus# configure terminal
awplus(config)# tacacs-server key secret
```

To delete the global secret key for TACACS+ server, use the following commands:

```
awplus# configure terminal
awplus(config)# no tacacs-server key
```

Related commands [tacacs-server host](#)
[show tacacs+](#)

tacacs-server timeout

Overview Use this command to specify the TACACS+ global timeout value. The timeout value is how long the device waits for a reply to a TACACS+ request before considering the server to be dead.

Note that this command configures the **timeout** parameter for TACACS+ servers globally.

The **no** variant of this command resets the transmit timeout to the default (5 seconds).

Syntax tacacs-server timeout <seconds>
no tacacs-server timeout

Parameter	Description
<seconds>	TACACS+ server timeout in seconds, in the range 1 to 1000.

Default The default timeout value is 5 seconds.

Mode Global Configuration

Examples To set the timeout value to 3 seconds, use the following commands:

```
awplus# configure terminal  
awplus(config)# tacacs-server timeout 3
```

To reset the timeout period for TACACS+ servers to the default, use the following commands:

```
awplus# configure terminal  
awplus(config)# no tacacs-server timeout
```

Related commands [tacacs-server host](#)
[show tacacs+](#)

Part 6: High Availability

49

High Availability Commands

Introduction

Overview This chapter provides an alphabetical reference of commands used to configure high availability. For more information, see the [High Availability Feature Overview and Configuration_Guide](#).

- Command List**
- “ha associate” on page 2451
 - “wan-bypass (interface mode)” on page 2453

ha associate

Overview This command is used to change the mode of a VRRP session to High Availability (HA) mode, and to associate it with a HA bypass port.

Use the **no** variant of this command to take the VRRP session out of HA-Mode.

Syntax `ha associate [wan-bypass <1-2>]`
`no ha associate [wan-bypass <1-2>]`

Parameter	Description
<code><wan-bypass></code>	The control wan bypass port.
<code><1-2></code>	The identifier number of wan bypass port.

Default The default state of bypass port 1 and port 2 is deactivated.

Mode Router Configuration

Usage notes One VRRP session can have the control of one or two bypass ports. After VRRP has the control of the wan-bypass ports, the state of the wan-bypass ports will be determined by the VRRP state. If the VRRP session is in master state, then the associated wan-bypass ports will be deactivated. If the VRRP session is in backup or initial state, then the associated wan-bypass ports will be activated.

If no wan-bypass ports are specified, then it puts the VRRP session in HA mode and the wan-bypass ports will always be deactivated.

If there are one or more VRRP sessions running in HA mode, then the wan-bypass ports should not be controlled by an other feature.

Examples To change a VRRP session into HA mode, use the following commands:

```
awplus#configure terminal
awplus(config)#router vrrp 1 vlan1
awplus(config-router)#ha associate
```

To change a VRRP session into HA mode and allow it to control wan-bypass port 1, use the following commands:

```
awplus#configure terminal
awplus(config)#vrrp 1 vlan1
awplus(config-router)#ha associate wan-bypass 1
```

To change a VRRP session to stop control of a wan-bypass port 1, use the following commands:

```
awplus#configure terminal
awplus(config)#router vrrp 1 vlan1
awplus(config-router)#no ha associate wan-bypass 1
```

To change a VRRP session out of HA-mode, use the following commands:

```
awplus#configure terminal
awplus(config)#router vrrp 1 vlan1
awplus(config-router)#no ha associate
```

**Related
commands** [show vrrp](#)

wan-bypass (interface mode)

Overview Use this command to manually activate bypass mode for a device's Ethernet interface. In bypass mode, the Ethernet interface is electrically disconnected from the device and diverted to the associated bypass port.

Use the **no** variant of this command to deactivate bypass mode.

Syntax wan-bypass
no wan-bypass

Default Bypass mode is deactivated by default.

Mode Interface Configuration for an Eth interface.

Example To activate bypass mode on the interface eth1, use the commands:

```
awplus# configure terminal
awplus(config)# interface eth1
awplus(config-if)# wan-bypass
```

To deactivate bypass mode on the interface eth1, use the commands:

```
awplus# configure terminal
awplus(config)# interface eth1
awplus(config-if)# no wan-bypass
```

Related commands [ha associate](#)

Command changes Version 5.5.0-1.3: command added

50

VRRP Commands

Introduction

Overview This chapter provides an alphabetical reference for commands used to configure the Virtual Router Redundancy Protocol (VRRP). For more information, see the [VRRP Feature Overview and Configuration Guide](#).

For information on filtering and saving command output, see the [“Getting Started with AlliedWare Plus” Feature Overview and Configuration Guide](#).

- Command List**
- [“advertisement-interval”](#) on page 2456
 - [“alternate-checksum-mode”](#) on page 2458
 - [“circuit-failover”](#) on page 2459
 - [“debug vrrp”](#) on page 2461
 - [“debug vrrp events”](#) on page 2462
 - [“debug vrrp packet”](#) on page 2463
 - [“disable \(VRRP\)”](#) on page 2464
 - [“enable \(VRRP\)”](#) on page 2465
 - [“preempt-mode”](#) on page 2466
 - [“priority”](#) on page 2468
 - [“router ipv6 vrrp \(interface\)”](#) on page 2470
 - [“router vrrp \(interface\)”](#) on page 2472
 - [“show debugging vrrp”](#) on page 2474
 - [“show running-config router ipv6 vrrp”](#) on page 2475
 - [“show running-config router vrrp”](#) on page 2476
 - [“show vrrp”](#) on page 2477
 - [“show vrrp counters”](#) on page 2479
 - [“show vrrp ipv6”](#) on page 2482

- [“show vrrp \(session\)”](#) on page 2483
- [“transition-mode”](#) on page 2485
- [“undebug vrrp”](#) on page 2487
- [“undebug vrrp events”](#) on page 2488
- [“undebug vrrp packet”](#) on page 2489
- [“virtual-ip”](#) on page 2490
- [“virtual-ipv6”](#) on page 2492
- [“vrrp vmac”](#) on page 2494

advertisement-interval

Overview Use this command to configure the advertisement interval of the virtual router. This is the length of time, in seconds, between each advertisement sent from the master to its backup(s).

IPv6 VRRP advertisements are sent to the multicast address assigned to the VRRP group (ff02:0:0:0:0) and a backup virtual router has to join all multicast groups within this range. VRRP advertisements are sent to a multicast address (ff02::12) every second by default.

Use the **no** variant of this command to remove an advertisement interval of the virtual router, which has been set using the **advertisement-interval** command, and revert to the default advertisement interval of 1 second.

Syntax advertisement-interval [`<1-255>`|csec `<1-4095>`]
no advertisement-interval

Parameter	Description
<code><1-255></code>	Specifies the advertisement interval in seconds.
csec	Use centiseconds instead of seconds for the advertisement interval.
<code><1-4095></code>	Specifies the advertisement interval in centiseconds.

Default The default advertisement interval is 1 second.

Mode Router Configuration

Usage notes See the [VRRP Feature Overview and Configuration Guide](#) for more information about:

- setting the advertisement-interval when configuring VRRP
- using seconds for VRRPv2 host compatibility whenever you use [transition-mode](#) to upgrade or transition from VRRPv2 to VRRPv3
- VRRPv3 IPv4 configuration details
- VRRPv3 IPv6 configuration details

Examples The example below shows you how to configure the advertisement interval to 6 seconds for the VRRP IPv4 session with VR ID 5 on interface vlan2:

```
awplus# configure terminal
awplus(config)# router vrrp 5 vlan2
awplus(config-router)# advertisement-interval 6
```

The example below shows you how to reset the advertisement interval to the default of 1 second for the VRRP IPv4 session with VR ID 5 on interface vlan2:

```
awplus# configure terminal
awplus(config)# router vrrp 5 vlan2
awplus(config-router)# no advertisement-interval
```

The example below shows you how to configure the advertisement interval to 6 seconds for the VRRPv3 IPv6 session with VR ID 5 on interface vlan2:

```
awplus# configure terminal
awplus(config)# router ipv6 vrrp 5 vlan2
awplus(config-router)# advertisement-interval 6
```

Related commands

- [router vrrp \(interface\)](#)
- [router ipv6 vrrp \(interface\)](#)

alternate-checksum-mode

Overview Use this command to enable an alternate checksum mode for VRRPv3 to allow inter-operability with some other vendors' products. The IPv4 checksum for VRRPv3 advertisements will then use a pseudo header in the calculation.

This mode may be required if the other product indicates checksum errors on VRRP packets sent by AlliedWare Plus devices.

Use the **no** variant of this command to disable the alternate checksum mode.

Syntax `alternate-checksum-mode`
`no alternate-checksum-mode`

Default Disabled

Mode Router Configuration

Example To turn on the alternate checksum mode for VRRP instance 1 on VLAN1, use the commands:

```
awplus# configure terminal
awplus(config)# router vrrp 1 vlan1
awplus(config-router)# alternate-checksum-mode
```

To turn off the alternate checksum mode for VRRP instance 1 on VLAN1, use the commands:

```
awplus# configure terminal
awplus(config)# router vrrp 1 vlan1
awplus(config-router)# no alternate-checksum-mode
```

Related commands [show running-config](#)

Command changes Version 5.4.7-1.1: command added

circuit-failover

Overview Use this command to enable the VRRP circuit failover feature.

Circuit failover enables the device to take action if the uplink interface goes down, so that the VRRP backup, whose uplink interface is still active, takes over as VRRP master. See the Usage section below and the [VRRP Feature Overview and Configuration Guide](#) for more information.

Use the **no** variant of this command to disable this feature.

Syntax `circuit-failover <interface> <1-253>`
`no circuit-failover [<interface> <1-253>]`

Parameter	Description
<code><interface></code>	The interface of the router that is monitored. The interface must exist on the router, and is usually an upstream interface. Should the interface go down, then another router that is configured as a backup router in the group takes over as the master. You should configure the circuit failover on an interface other than the active VRRP interface - generally the uplink interface.
<code><1-253></code>	Delta value. The value by which virtual routers decrement their priority value during a circuit failover event. Configure this value to be greater than the difference of priorities on the master and backup routers. In the case of failover, this priority delta value is subtracted from the current VR Master Router priority value.

Mode Router Configuration

Usage notes You can use Circuit Failover to monitor up to 32 interfaces per VRRP instance. If a VRRP instance is configured to monitor multiple interfaces, the VRRP priority will be cumulatively decremented by the configured delta for each interface as it goes down.

For example, if VRRP is configured to monitor VLAN2 and VLAN3 with the commands:

```
awplus# configure terminal
awplus(config)# interface vlan1
awplus(config-if)# ip address 192.168.1.1/24
awplus(config-if)# exit
awplus(config)# router vrrp 1 vlan1
awplus(config-router)# virtual-ip 192.168.1.10 backup
awplus(config-router)# priority 100
awplus(config-router)# circuit-failover vlan2 10
awplus(config-router)# circuit-failover vlan3 20
```

then the following examples explain the effect of each VLAN going down:

- If only VLAN2 fails, then the VRRP priority will be decremented by 10. VRRP priority would be adjusted to become 90, because $100 - 10 = 90$.
- If only VLAN3 fails, then the VRRP priority will be decremented by 20. VRRP priority would be adjusted to become 80, because $100 - 20 = 80$.
- If both VLAN2 and VLAN3 fail, then the VRRP priority will be decremented by the cumulative delta values of all monitored interfaces. VRRP priority would therefore be adjusted to become 70, because $100 - 10 - 20 = 70$.

As each monitored interface recovers, the VRRP priority is incremented by the same delta value.

When you configure the delta values of the monitored interfaces, make sure their sum is high enough to ensure that the VRRP priority stays above zero if all the interfaces go down.

Examples To configure circuit failover on an IPv4 VRRP instance, so that if interface VLAN3 goes down, then the priority of VRRP instance 1 is reduced by 30, use the commands:

```
awplus# configure terminal
awplus(config)# router vrrp 1 vlan2
awplus(config-router)# circuit-failover vlan3 30
```

To remove all configured circuit failovers for the VRRP IPv4 session with VR ID 1 on interface vlan2, use the commands:

```
awplus# configure terminal
awplus(config)# router vrrp 1 vlan2
awplus(config-router)# no circuit-failover
```

To configure circuit failover on a VRRPv3 IPv6 session with VR ID 1, so that when interface VLAN3 goes down, the priority of VRRP instance 1 is reduced by 30, use the commands:

```
awplus# configure terminal
awplus(config)# router ipv6 vrrp 1 vlan2
awplus(config-router)# circuit-failover vlan3 30
```

To remove all configured circuit failovers for the VRRPv3 IPv6 session with VR ID 1 on interface vlan2, use the commands:

```
awplus# configure terminal
awplus(config)# router ipv6 vrrp 1 vlan2
awplus(config-router)# no circuit-failover
```

Related commands [router vrrp \(interface\)](#)
[router ipv6 vrrp \(interface\)](#)

debug vrrp

Overview Use this command to specify debugging options for VRRP. The **all** parameter turns on all the debugging options.

Use the **no** variant of this command to disable this function.

Syntax `debug vrrp [all]`
`no debug vrrp [all]`

Mode Privileged Exec and Global Configuration

Usage notes See the [VRRP Feature Overview and Configuration Guide](#) for more information about VRRPv3 debugging details.

Examples The example below shows you how to enable all debugging for VRRP:

```
awplus# configure terminal
awplus(config)# debug vrrp all
```

The example below shows you how to disable all debugging for VRRP:

```
awplus# configure terminal
awplus(config)# no debug vrrp all
```

Related commands [show debugging vrrp](#)
[undebug vrrp](#)

debug vrrp events

Overview Use this command to specify debugging options for VRRP event troubleshooting. Use the **no** variant of this command to disable this function.

Syntax `debug vrrp events`
`no debug vrrp events`

Mode Privileged Exec and Global Configuration

Usage notes The **debug vrrp events** command enables the display of debug information related to VRRP internal events.
See the [VRRP Feature Overview and Configuration Guide](#) for more information about VRRPv3 debugging details.

Examples The example below shows you how to enable events debugging for VRRP:

```
awplus# configure terminal
awplus(config)# debug vrrp events
```

The example below shows you how to disable events debugging for VRRP:

```
awplus# configure terminal
awplus(config)# no debug vrrp events
```

Related commands [show debugging vrrp](#)
[undebug vrrp events](#)

debug vrrp packet

Overview Use this command to specify debugging options for VRRP packets.
Use the **no** variant of this command to disable this function.

Syntax debug vrrp packet [send|recv]
no debug vrrp packet [send|recv]

Parameter	Description
send	Specifies the debug option set for sent packets.
recv	Specifies the debug option set for received packets.

Mode Privileged Exec and Global Configuration

Usage notes The **debug vrrp packet** command enables the display of debug information related to the sending and receiving of packets.

See the [VRRP Feature Overview and Configuration Guide](#) for more information about VRRPv3 debugging details.

Examples The example below shows you how to enable received and sent packet debugging for VRRP:

```
awplus# configure terminal
awplus(config)# debug vrrp packet
```

The example below shows you how to enable only received packet debugging for VRRP:

```
awplus# configure terminal
awplus(config)# debug vrrp packet recv
```

The example below shows you how to enable only sent packet debugging for VRRP:

```
awplus# configure terminal
awplus(config)# debug vrrp packet send
```

The example below shows you how to disable packet debugging for VRRP:

```
awplus# configure terminal
awplus(config)# no debug vrrp packet
```

Related commands [show debugging vrrp](#)
[undebug vrrp packet](#)

disable (VRRP)

Overview Use this command to disable a VRRP IPv4 session or a VRRPv3 IPv6 session on the router to stop it participating in virtual routing. Note that when this command is configured then a backup router assumes the role of master router depending on its priority. See the [enable \(VRRP\)](#) command to enable a VRRP IPv4 session or a VRRPv3 IPv6 session on the router.

Syntax `disable`

Mode Router Configuration

Usage notes See the [VRRP Feature Overview and Configuration Guide](#) for more information about VRRPv3 IPv4 and IPv6 configuration details.

Examples The example below shows you how to disable the VRRP session for VRRP VR ID 5 on vlan2:

```
awplus# configure terminal
awplus(config)# router vrrp 5 vlan2
awplus(config-router)# disable
```

The example below shows you how to disable the VRRPv3 session for VRRPv3 VR ID 3 on vlan1:

```
awplus# configure terminal
awplus(config)# router ipv6 vrrp 3 vlan1
awplus(config-router)# disable
```

Related commands

- [enable \(VRRP\)](#)
- [router vrrp \(interface\)](#)
- [router ipv6 vrrp \(interface\)](#)
- [show vrrp](#)

enable (VRRP)

Overview Use this command to enable the VRRP session on the router to make it participate in virtual routing. To make changes to the VRRP configuration, first disable the router from participating in virtual routing using the [disable \(VRRP\)](#) command.

Syntax enable

Mode Router Configuration

Usage notes You must configure the virtual IP address and define the interface for the VRRP session (using the [virtual-ip](#) or [virtual-ipv6](#) and the [router vrrp \(interface\)](#) or [router ipv6 vrrp \(interface\)](#) commands) before using this command.

See the [VRRP Feature Overview and Configuration Guide](#) for more information about VRRPv3 IPv4 and IPv6 configuration details.

Examples To enable the VRRP session for VRRP VR ID 5 on vlan2, use the commands:

```
awplus# configure terminal
awplus(config)# router vrrp 5 vlan2
awplus(config-router)# enable
```

To enable the VRRPv3 session for VRRPv3 VR ID 3 on vlan1, use the commands:

```
awplus# configure terminal
awplus(config)# router ipv6 vrrp 3 vlan1
awplus(config-router)# enable
```

Related commands

- [disable \(VRRP\)](#)
- [router vrrp \(interface\)](#)
- [router ipv6 vrrp \(interface\)](#)
- [show vrrp](#)
- [virtual-ip](#)
- [virtual-ipv6](#)

preempt-mode

Overview Use this command to configure preempt mode. If preempt-mode is set to **true**, then the highest priority backup will always be the master when the default master is unavailable.

If preempt-mode is set to **false**, then a higher priority backup will not preempt a lower priority backup who is acting as master.

If preempt-mode is set to **true**, an extra parameter is available called **delay-time**. If the delay-time parameter is used, a VRRP router with a higher priority will wait the configured length of time before it preempts the lower priority VRRP router to take over as master.

Syntax `preempt-mode {true|false}[delay-time <0-3600>]`

Parameter	Description
true	Preemption is enabled.
false	Preemption is disabled.
delay-time	Enable preempting but delay the preempt by the amount of seconds specified by the delay-time value. Note, a delay-time of 0 means delayed preempting is disabled.

Default The default is **true**.

Mode Router Configuration

Usage notes When the master router fails, the backup routers come online in priority order—highest to lowest. Preempt mode means that a higher priority backup router will take over the master role from a lower priority backup. Preempt mode set to **true** allows a higher priority backup router to relieve a lower priority backup router.

By default, a preemptive scheme is enabled whereby a higher priority backup virtual router that becomes available takes over from the backup virtual router that was previously elected to become the master virtual router.

This preemptive scheme can be disabled using the **preempt-mode false** command. If preemption is disabled on a backup virtual router that is starting up, and this router has a higher priority than the current master, the higher priority backup will not preempt the current master, and the lower priority master will stay in the master role.

See the [VRRP Feature Overview and Configuration Guide](#) for more information about:

- VRRPv3 IPv4 configuration details
- VRRPv3 IPv6 configuration details
- preempt mode and preempt delay-time

Examples The example below shows you how to configure preempt-mode as true for VRRP VR ID 5 on vlan2:

```
awplus# configure terminal
awplus(config)# router vrrp 5 vlan2
awplus(config-router)# preempt-mode true
```

The example below shows you how to configure preempt-mode as false for VRRP VR ID 5 on vlan2:

```
awplus# configure terminal
awplus(config)# router vrrp 5 vlan2
awplus(config-router)# preempt-mode false
```

The example below shows you how to configure preempt-mode as true for VRRPv3 VR ID 3 on vlan1:

```
awplus# configure terminal
awplus(config)# router ipv6 vrrp 3 vlan1
awplus(config-router)# preempt-mode true
```

The example below shows you how to configure preempt-mode as false for VRRPv3 VR ID 3 on vlan1:

```
awplus# configure terminal
awplus(config)# router ipv6 vrrp 3 vlan1
awplus(config-router)# preempt-mode false
```

The example below shows you how to configure delay-time as 20 seconds for VRRPv3 VR ID 5 on vlan5:

```
awplus# configure terminal
awplus(config)# router ipv6 vrrp 5 vlan5
awplus(config-router)# preempt-mode true delay-time 20
```

Related commands

- [circuit-failover](#)
- [priority](#)
- [router vrrp \(interface\)](#)
- [router ipv6 vrrp \(interface\)](#)

priority

Overview Use this command to configure the VRRP router priority within the virtual router. The highest priority router is Master (unless [preempt-mode](#) is false).

Use the **no** variant of this command to remove the VRRP router priority within the virtual router, which has been set using the **priority** command.

Syntax `priority <1-255>`
`no priority`

Parameter	Description
<1-255>	The priority. For the master router, use 255 for this parameter; otherwise use any number from the range <1-254>.

Default Defaults for priority are: **master router**= 255; **backup**= 100.

Mode Router Configuration

Usage notes Priority determines the role that each VRRP router plays and what happens if the master virtual router fails. If a VRRP router owns the IP address of the virtual router and the IP address of the interface, then this VRRP router functions as the master virtual router.

Priority also determines whether a VRRP router functions as a backup virtual router and the order of ascendancy to becoming a master virtual router if the master virtual router fails. Configure the priority of each backup virtual router with a value of 1 through 254.

See the [VRRP Feature Overview and Configuration Guide](#) for more information about VRRPv3 IPv4 and IPv6 configuration details.

Examples The example below shows you how to configure 101 as the priority for VRRP VR ID 5 on vlan2:

```
awplus# configure terminal
awplus(config)# router vrrp 5 vlan2
awplus(config-router)# priority 101
```

The example below shows you how to remove the priority configured for VRRP VR ID 5 on vlan2:

```
awplus# configure terminal
awplus(config)# router vrrp 5 vlan2
awplus(config-router)# no priority
```

The example below shows you how to configure 101 as the priority for VRRPv3 VR ID 3 on vlan1:

```
awplus# configure terminal
awplus(config)# router ipv6 vrrp 3 vlan1
awplus(config-router)# priority 101
```

The example below shows you how to remove the configured priority for VRRPv3 VR ID 3 on vlan1:

```
awplus# configure terminal
awplus(config)# router ipv6 vrrp 3 vlan1
awplus(config-router)# no priority
```

Related commands [circuit-failover](#)
[preempt-mode](#)

router ipv6 vrrp (interface)

Overview Use this command to configure VRRPv3 for IPv6 and define the interface that will participate in virtual routing to send and receive advertisement messages. This command allows you to enter the Router Configuration mode.

Use the **no** variant of this command to remove the VRRPv3 for IPv6 configuration. Disable the VRRP session before using the **no** variant of this command.

Syntax `router ipv6 vrrp <vrid> <interface>`
`no router ipv6 vrrp <vrid> <interface>`

Parameter	Description
<vrid>	<1-255> The ID of the virtual router VRRPv3 IPv6 session to create.
<interface>	Specify the name of the interface that will participate in the virtual routing. The interface must exist on the router. The interface specified sends and receives VRRPv3 IPv6 advertisement messages.

Mode Global Configuration

Usage notes Use the required <interface> placeholder to define the interface that will participate in virtual routing. This interface is used for two purposes - to send/receive advertisement messages and to forward on behalf of the virtual router when in master state.

NOTE: *Tunnels and PPP interfaces are not supported. VRRP is only configurable on VLANs.*

NOTE: *Configuring a high number of instances may adversely affect the device's performance, depending on the device CPU, the other protocols it is running, and whether you set the advertisement interval to less than 1 second.*

See the [VRRP Feature Overview and Configuration Guide](#) for more information about VRRPv3 IPv6 configuration details.

Examples The example below shows you how to enable a VRRPv3 session with VR ID 3 on vlan2:

```
awplus# configure terminal
awplus(config)# router ipv6 vrrp 3 vlan2
awplus(config-router)# enable
awplus(config-router)#
```

The example below shows you how to disable a VRRPv3 session with VR ID 3 on vlan2:

```
awplus(config-router)# disable
awplus(config-router)# exit
awplus(config)# no router ipv6 vrrp 3 vlan2
awplus(config)#
```

Related commands [advertisement-interval](#)
[circuit-failover](#)

router vrrp (interface)

Overview Use this command to configure VRRP IPv4 and define the interface that will participate in virtual routing to send and receive advertisement messages. This command allows you to enter the Router Configuration mode.

Use the **no** variant of this command to remove the VRRP IPv4 configuration. Disable the VRRP session before using the **no** variant of this command.

Syntax `router vrrp <vrid> <interface>`
`no router vrrp <vrid> <interface>`

Parameter	Description
<vrid>	<1-255> The ID of the virtual router VRRP IPv4 session to create.
<interface>	Specify the name of the interface that will participate in the virtual routing. The interface must exist on the router. The interface specified sends and receives VRRP IPv4 advertisement messages.

Mode Global Configuration

Usage notes Use the required <interface> placeholder to define the interface that will participate in virtual routing. This interface is used for two purposes - to send/receive advertisement messages and to forward on behalf of the virtual router when in master state.

NOTE: *Tunnels and PPP interfaces are not supported. VRRP is only configurable on VLANs*

NOTE: *Configuring a high number of instances may adversely affect the device's performance, depending on the device CPU, the other protocols it is running, and whether you set the advertisement interval to less than 1 second.*

See the [VRRP Feature Overview and Configuration Guide](#) for more information about VRRPv3 IPv4 configuration details.

Examples To enable a VRRP session with VR ID 5 on vlan1, use the commands:

```
awplus# configure terminal
awplus(config)# router vrrp 5 vlan1
awplus(config-router)# enable
```

To disable a VRRP session with VR ID 5 on vlan1, use the commands:

```
awplus(config-router)# disable
awplus(config-router)# exit
awplus(config)# no router vrrp 5 vlan1
```

Related commands

- advertisement-interval
- circuit-failover
- disable (VRRP)
- enable (VRRP)

show debugging vrrp

Overview Use this command to display the set VRRP debugging option. Use the terminal monitor command to display output on the console otherwise debug output is in the log file.

For information on filtering and saving command output, see the [“Getting Started with AlliedWare Plus” Feature Overview and Configuration Guide](#).

See the [VRRP Feature Overview and Configuration Guide](#) for more information about VRRPv3 debugging details.

Syntax `show debugging vrrp`

Mode User Exec and Privileged Exec

Example The example below shows you how to display VRRP debugging:

```
awplus# show debugging vrrp
```

Related commands

- [debug vrrp](#)
- [debug vrrp events](#)
- [debug vrrp packet](#)

show running-config router ipv6 vrrp

Overview Use this command to show the running configuration for VRRPv3 IPv6.

For information on filtering and saving command output, see the [“Getting Started with AlliedWare Plus” Feature Overview and Configuration Guide](#).

See the [VRRP Feature Overview and Configuration Guide](#) for more information about VRRPv3 IPv6 configuration details.

Syntax `show running-config router vrrp`

Mode Privileged Exec, Global Configuration, Line Configuration, and Interface Configuration.

Example The example below shows you how to display the running configuration for VRRPv3 IPv6:

```
awplus# show running-config router ipv6 vrrp
```

Output Figure 50-1: Example output from the **show running-config router ipv6 vrrp** command

```
!  
router ipv6 vrrp 3 vlan3  
  virtual-ip fe80::202:b3ff:fed5:983e master  
  circuit-failover vlan3 3  
  advertisement-interval 6  
  preempt-mode false  
!
```

show running-config router vrrp

Overview Use this command to show the running configuration for VRRP IPv4.

For information on filtering and saving command output, see the [“Getting Started with AlliedWare Plus” Feature Overview and Configuration Guide](#).

See the [VRRP Feature Overview and Configuration Guide](#) for more information about VRRPv3 IPv4 configuration details.

Syntax `show running-config router vrrp`

Mode Privileged Exec, Global Configuration, Line Configuration, and Interface Configuration.

Example The example below shows you how to display the running configuration for VRRP IPv4:

```
awplus# show running-config router vrrp
```

Output Figure 50-2: Example output from the **show running-config router vrrp** command

```
!  
router vrrp 2 vlan2  
  circuit-failover vlan2 2  
  advertisement-interval 4  
  preempt-mode true  
!
```

show vrrp

Overview Use this command to display information about all VRRP IPv4 sessions. This command shows a summary when the optional **brief** parameter is used.

For information on filtering and saving command output, see the [“Getting Started with AlliedWare Plus” Feature Overview and Configuration Guide](#).

See the [VRRP Feature Overview and Configuration Guide](#) for more information about VRRPv3 IPv4 configuration details.

Syntax show vrrp [brief]

Parameter	Description
brief	Brief summary of VRRP sessions.

Mode User Exec and Privileged Exec

Example To display information about all VRRP IPv4 sessions, enter the command:

```
awplus# show vrrp
```

To display brief summary output about VRRP IPv4 sessions, enter the command:

```
awplus# show vrrp brief
```

Output Figure 50-3: Example output from the **show vrrp** command

```
awplus#show vrrp
VMAC enabled
Address family IPv4
VRRP Id: 1 on interface: vlan2
State: AdminUp - Master
Virtual IP address: 192.168.1.2 (Not-owner)
Priority is 100
Advertisement interval: 100 centiseconds
Preempt mode: TRUE
Multicast membership on IPv4 interface vlan2: JOINED
Transition mode: FALSE
Accept mode: FALSE
Master address: 192.168.1.3
High Availability: enabled
wan-bypass 1 (eth1) is on
```

Figure 50-4: Example output from the **show vrrp brief** command

```
awplus#show vrrp brief
Interface      Grp  Prio Own  Pre  State      Master addr      Group addr
vlan10         1   200  N    P    Master     192.168.10.4     192.168.10.253
vlan10         2   150  N    P    Backup     192.168.10.4     192.168.10.254
vlan11         3   200  N    P    Master     192.168.11.4     192.168.11.253
vlan11         4   150  N    P    Backup     192.168.11.4     192.168.11.254
```

**Related
commands** enable (VRRP)
 disable (VRRP)

show vrrp counters

Overview This command displays VRRP SNMP counters on the console, as described in the VRRP MIB and RFC2787, for debugging use while you configure VRRP with commands in this chapter.

For information on filtering and saving command output, see the [“Getting Started with AlliedWare Plus” Feature Overview and Configuration Guide](#).

Syntax `show vrrp counters`

Mode User Exec and Privileged Exec

Usage notes The output has a section for global counters and a section of counters for each VRRP instance configured. See the descriptions of the counters below the sample output as per RFC2787.

NOTE: Note that the counters displayed with this commands are the same counters as described in RFC 2787 (Copyright (C) The Internet Society (2000). All Rights Reserved) except for the “Monitored Circuit Up” and “Monitored Circuit Down” counters, which are additions beyond the MIB.

Example To display information about VRRP SNMP counters on the console, enter the command:

```
awplus# show vrrp counters
```

Figure 50-5: Example output from the **show vrrp counters** command

```
awplus#show vrrp counters
VRRP Global Counters:
  Checksum Errors .... 230
  Version Errors ..... 0
  VRID Errors ..... 230

VRRP IPv4 counters for VR 10/vlan10:
  Master Transitions ..... 0
  Received Advertisements ... 0
  Internal Errors ..... 0
  TTL Errors ..... 0
  Received Priority 0 Pkt ... 0
  Sent Priority 0 Pkt ..... 0
  Received Invalid Type ..... 0
  Address List Errors ..... 0
  Packet Length Errors ..... 0
  Monitored Circuit Up ..... 0
  Monitored Circuit Down..... 0
```

```
VRRP IPv4 counters for VR 100/vlan100:
Master Transitions ..... 1
Received Advertisements ... 1614
Internal Errors ..... 0
TTL Errors ..... 0
Received Priority 0 Pkt ... 0
Sent Priority 0 Pkt ..... 0
Received Invalid Type ..... 0
Address List Errors ..... 0
Packet Length Errors ..... 0
Monitored Circuit Up ..... 0
Monitored Circuit Down.... 2
```

Table 1: Global counters with descriptions for the **show vrrp counters** command:

Counter	Description
Checksum Errors	The total number of VRRP packets received with an invalid VRRP checksum value.
Version Errors	The total number of VRRP packets received with an unknown or unsupported version number.
VRID Errors	The total number of VRRP packets received with an invalid VRID for this virtual router.

Table 2: Per VR counters with descriptions for the **show vrrp counters** command:

Counter	Description
Master Transitions	The total number of times that this virtual router's state has transitioned to MASTER.
Received Advertisements	The total number of VRRP advertisements received by this virtual router.
Internal Errors	The total number of VRRP advertisement packets received for which the advertisement interval is different than the one configured for the local virtual router.
TTL Errors	The total number of VRRP packets received by the virtual router with IP TTL (Time-To-Live) not equal to 255.
Received Priority 0 Pkt	The total number of VRRP packets received by the virtual router with a priority of '0'.
Sent Priority 0 Pkt	The total number of VRRP packets sent by the virtual router with a priority of '0'.
Received Invalid Type	The number of VRRP packets received by the virtual router with an invalid value in the 'type' field.
Address List Errors	The total number of packets received for which the address list does not match the locally configured list for the virtual router.

Table 2: Per VR counters with descriptions for the **show vrrp counters** command: (cont.)

Counter	Description
Packet Length Errors	The total number of packets received with a packet length less than the length of the VRRP header.
Monitored Circuit Up	The total number of times the monitored circuit has generated the UP event.
Monitored Circuit Down	The total number of times the monitored circuit has generated the down event.

show vrrp ipv6

Overview Use this command to display information about all configured VRRPv3 IPv6 sessions for all interfaces, or all VRRPv3 IPv6 sessions for a given interface with the optional parameter.

For information on filtering and saving command output, see the [“Getting Started with AlliedWare Plus” Feature Overview and Configuration Guide](#).

See the [VRRP Feature Overview and Configuration Guide](#) for more information about VRRPv3 IPv6 configuration details.

Syntax `show vrrp ipv6 [<interface>]`

Parameter	Description
<code><interface></code>	Specify the name of the interface that will participate in the virtual routing. The interface must exist on the router. The interface specified sends and receives VRRPv3 IPv6 advertisement messages.

Mode User Exec and Privileged Exec

Example To display information about all VRRPv3 IPv6 sessions, enter the command:

```
awplus# show vrrp ipv6
```

Output Figure 50-6: Example output from the **show vrrp ipv6 vlan2** command

```
awplus#show vrrp ipv6 vlan2
VrId <1>
  State is Master
  Virtual IP is fe80::202:b3ff:fed5:983e (Owner)
  Interface is vlan2
  Priority is 255
  Advertisement interval is 4 sec
  Preempt mode is FALSE
```

Related commands [enable \(VRRP\)](#)
[disable \(VRRP\)](#)

show vrrp (session)

Overview Use this command to display information for a particular VRRP session.

For information on filtering and saving command output, see the [“Getting Started with AlliedWare Plus” Feature Overview and Configuration Guide](#).

See the [VRRP Feature Overview and Configuration Guide](#) for more information about VRRPv3 IPv4 configuration details.

Syntax `show vrrp <vrid> <interface>`

Parameter	Description
<code><vrid></code>	<code><1-255></code> The virtual router ID for which to display information. Session must already exist.
<code><interface></code>	The interface to display information about, for instance, <code>vlan2</code> .

Mode User Exec and Privileged Exec

Usage notes See the below sample output from the **show vrrp** command displaying information about VRRP session 1 configured on **vlan2**. Output shows that a Virtual IP address has been set.

```
awplus# show vrrp 1 vlan2
```

```
awplus#show vrrp 1 vlan2
Address family IPv4
VrId <1>
  Interface is vlan2
  State is Initialize
  Virtual IP address is 10.10.11.250 (Not IP owner)
  Priority is 100
  Advertisement interval is 1 sec
  Preempt mode is TRUE
  Multicast membership on IPv4 interface vlan1: JOINED
  Transition mode: FALSE
  Accept mode: TRUE
  Master address: 192.168.24.5
  High Availability:
  enabled
  wan-bypass 1 (eth1) is on
```

See the below sample output from the **show vrrp** command displaying information about VRRP session 1 configured on **vlan3**. Output shows a Virtual IP address has not been set.

```
awplus# show vrrp 1 vlan3
```

```
awplus#show vrrp 1 vlan3
Address family IPv4
VrId <1>
  Interface is vlan3
  State is Initialize
  Virtual IP address is unset
  Priority is 100
  Advertisement interval is 1 sec
  Preempt mode is TRUE
Preempt mode is TRUE
Multicast membership on IPv4 interface vlan3: JOINED
Transition mode: FALSE
Accept mode: TRUE
Master address: 192.168.24.5
High Availability:
enabled
  wan-bypass 1 (eth1) is on
```

Example The following command shows information about VRRP session 5 for interface **vlan2**.

```
awplus# show vrrp 5 vlan2
```

transition-mode

Overview Use this command to configure the IPv4 transition mode. Transition mode allows you to upgrade from VRRPv2 to VRRPv3 and gives interoperability between VRRPv2 and VRRPv3.

If transition-mode is set to **true**, then the IPv4 transition mode is enabled and VRRPv2 and VRRPv3 advertisements are sent allowing VRRPv2 and VRRPv3 interoperability. Received VRRPv2 advertisement packets are accepted and processed when transition-mode is true.

If transition-mode is set to **false**, then the IPv4 transition mode is disabled and only VRRPv3 advertisements are sent. Received VRRPv2 advertisement packets are dropped.

Note the [advertisement-interval](#) should not be configured to less than 1 second when using transition-mode. VRRPv2 can only use advertisements in whole second intervals.

Syntax `transition-mode {true|false}`

Parameter	Description
true	Transition mode is enabled. This results in VRRPv2 and VRRPv3 IPv4 advertisements being sent. Transition mode is only available on VRRPv3 for interoperability with VRRPv2 while upgrading to VRRPv3.
false	Transition mode is disabled. This stops VRRPv2 IPv4 advertisements being sent. Only VRRPv3 advertisements are sent when disabled. Disable transition-mode after upgrading from VRRPv2 to VRRPv3.

Default The default is **false**.

Mode Router Configuration

Usage notes See the [VRRP Feature Overview and Configuration Guide](#) for more information:

- VRRPv3 IPv4 configuration details
- VRRPv3 IPv6 configuration details
- further information about configuring transition mode to upgrade from VRRPv2 to VRRPv3

Examples The example below shows you how to configure IPv4 transition-mode as true for VRRP VR ID 5 on vlan2:

```
awplus# configure terminal
awplus(config)# router vrrp 5 vlan2
awplus(config-router)# transition-mode true
```

The example below shows you how to configure IPv4 transition-mode as false for VRRP VR ID 5 on vlan2:

```
awplus# configure terminal
awplus(config)# router vrrp 5 vlan2
awplus(config-router)# transition-mode false
```

Related commands [router vrrp \(interface\)](#)

undebug vrrp

Overview Use this command to disable all VRRP debugging.

Syntax undebug vrrp all

Mode Privileged Exec

Example The example below shows you how to disable all VRRP debugging:

```
awplus# undebug vrrp all
```

Related commands [debug vrrp](#)

undebbug vrrp events

Overview Use this command to disable debugging options for VRRP event troubleshooting.

Syntax `undebbug vrrp events`

Mode Privileged Exec

Example The example below shows you how to disable VRRP event debugging:

```
awplus# undebbug vrrp events
```

Related commands [debug vrrp events](#)

undebbug vrrp packet

Overview Use this command to disable debugging options for VRRP packets.

Syntax `undebbug vrrp packet [send|recv]`

Parameter	Description
send	Disable the debug option set for sent packets.
recv	Disable the debug option set for received packets.

Mode Privileged Exec

Examples The example below shows you how to disable VRRP sent packet debugging:

```
awplus# undebbug vrrp packet send
```

The example below shows you how to disable VRRP received packet debugging:

```
awplus# undebbug vrrp packet recv
```

The example below shows you how to disable all VRRP packet debugging:

```
awplus# undebbug vrrp packet
```

Related commands [debug vrrp packet](#)

virtual-ip

Overview Use this command to set the virtual IP address for the VRRP session. This is the IP address of the virtual router that end hosts set as their default gateway.

Use the **no** variant of this command to disable this feature.

Syntax `virtual-ip <ip-address> [master|backup|owner]`
`no virtual-ip`

Parameter	Description
<code><ip-address></code>	The virtual IPv4 address of the virtual router, entered in dotted decimal format A.B.C.D.
<code>master</code>	Sets the default state of the VRRP router within the Virtual Router as master . For master, the router must own the Virtual IP address. Specify the owner option before using master option.
<code>backup</code>	Sets the default state of the VRRP router within the Virtual Router as backup .
<code>owner</code>	Sets the IPv6 address of the VRRP router within the Virtual Router as the owner . Specify this before using the master option.

Mode Router Configuration

Usage notes The VRRP master and owner of the virtual IPv4 address for the VRRP session only responds to the packets destined to the virtual IPv4 address. The VRRP master that is not an owner of the virtual IPv4 address for the VRRP session does not respond to the packets destined to the virtual IPv4 address, but forwards packets with a VMAC as the destination address. See the [vrrp vmac](#) command to enable and disable this feature.

See the [VRRP Feature Overview and Configuration Guide](#) for more information about VRRPv3 IPv4 configuration details.

Examples The example below shows you how to set the virtual IP address for VRRP VR ID 5 and the router as the VRRP master:

```
awplus# configure terminal
awplus(config)# router vrrp 5 vlan2
awplus(config-router)# virtual-ip 192.0.2.30 master
```

The example below shows you how to set the virtual IPv4 address for VRRP VR ID 5 and the router as the VRRP backup:

```
awplus# configure terminal
awplus(config)# router vrrp 5 vlan2
awplus(config-router)# virtual-ip 192.0.2.30 backup
```

The example below shows you how to set the virtual IPv4 address for VRRP VR ID 5 and the router as owner of the virtual IPv4 address:

```
awplus# configure terminal
awplus(config)# router vrrp 5 vlan2
awplus(config-router)# virtual-ip 192.0.2.30 owner
```

The example below shows you how to disable the virtual IPv4 address for VRRP VR ID 5

```
awplus# configure terminal
awplus(config)# router vrrp 5 vlan2
awplus(config-router)# no virtual-ip
```

Related commands

- [router vrrp \(interface\)](#)
- [enable \(VRRP\)](#)
- [vrrp vmac](#)

virtual-ipv6

Overview Use this command to set the virtual IPv6 address for the VRRPv3 session. This is the IPv6 address of the virtual router that end hosts set as their default gateway.

Note that the primary IPv6 address specified is an IPv6 link-local address. See the Usage note below for further information.

Use the **no** variant of this command to disable this feature.

Syntax

```
virtual-ipv6 <ipv6-address> [master|backup]
[primary|secondary]

no virtual-ipv6
```

Parameter	Description
<i><ipv6-address></i>	The IPv6 address of the virtual router, entered in hexadecimal, in the format X:X::X.X.
master	Sets master to be the default state of the VRRPv3 router within the Virtual Router. For master , we recommend using a Virtual IP address that is not owned by any of the VRRP routers in the same grouping (that share the same VRID).
backup	Sets backup to be the default state of the VRRPv3 router within the Virtual Router.
primary	Sets the specified address as the primary IPv6 address. The primary address must be a link-local IPv6 address.
secondary	Sets the specified address as the secondary IPv6 address. Normally this would be a globally-routable IPv6 address. This enables you to specify a globally-routable address as the default gateway address for all the hosts on a VLAN.

Mode Router Configuration

Usage notes The virtual router will reply to ping, telnet, and SSH requests to the virtual IP address. The virtual router will reply even if it does not own the virtual IP address.

The AlliedWare Plus VRRPv3 implementation supports one IPv6 virtual link local address per virtual router ID. Note that in the command examples fe80::1 is an IPv6 link-local address. An IPv6 link-local address is used because IPv6 link-local addresses are used by IPv6 ND (Neighbor Discovery). A host's default route to a router points to the IPv6 link-local address, not a specific global IPv6 address for the router. For the host's traffic to switch over to a backup router, the IPv6 link-local address of the router is used by VRRPv3.

See the [VRRP Feature Overview and Configuration Guide](#) for more information about VRRPv3 IPv6 configuration details.

Examples The example below shows you how to set the virtual IPv6 address for VRRPv3 VR ID 3 and the router as the VRRPv3 master:

```
awplus# configure terminal
awplus(config)# router ipv6 vrrp 3 vlan1
awplus(config-router)# virtual-ipv6 fe80::1 master
```

The example below shows you how to set the virtual IPv6 address for VRRPv3 VR ID 3 and the router as the VRRPv3 backup:

```
awplus# configure terminal
awplus(config)# router ipv6 vrrp 3 vlan1
awplus(config-router)# virtual-ipv6 fe80::1 backup
```

The example below shows you disable the virtual IPv6 address for VRRPv3 VR ID 3:

```
awplus# configure terminal
awplus(config)# router ipv6 vrrp 3 vlan1
awplus(config-router)# no virtual-ipv6
```

Related commands

- [router ipv6 vrrp \(interface\)](#)
- [enable \(VRRP\)](#)
- [vrrp vmac](#)

vrrp vmac

Overview Use this command to enable or disable the VRRP Virtual MAC feature. This feature is used by VRRP to make the hosts use the virtual MAC address as the physical hardware address of their gateway.

A VRRP router master will use the virtual MAC address for any ARP responses associated with the virtual IP address, or any gratuitous ARPs sent on behalf of the virtual IP address.

All VRRP advertisements are sent using this virtual MAC address as the source MAC address.

The virtual MAC address has the form 00:00:5e:00:01:<VRID>, where VRID is the ID of the Virtual Router.

Syntax `vrrp vmac {enable|disable}`

Mode Global Configuration

Examples To enable Virtual MAC enter:

```
awplus# configure terminal
awplus(config)# vrrp vmac enable
```

To disable Virtual MAC enter:

```
awplus# configure terminal
awplus(config)# vrrp vmac disable
```

Related commands [virtual-ip](#)
[virtual-ipv6](#)

Part 7: Network Management

51

Allied Telesis Management Framework™ (AMF) Commands

Introduction

Overview This chapter provides an alphabetical reference for Allied Telesis Management Framework™ (AMF) commands.

AMF master nodes Every AMF network must have at least one master node, which acts as the core of the AMF network. Not all AlliedWare Plus devices are capable of acting as an AMF master. See the [AMF Feature Overview and Configuration Guide](#) for information about AMF master support.

AMF edge AlliedWare Plus CentreCOM® Series switches can only be used as edge switches in an AMF network. The full management power and convenience of AMF is available on these switches, but they can only link to one other AMF node. They cannot form cross-links or virtual links.

AMF naming convention When AMF is enabled on a device, it will automatically be assigned a host name. If a host name has already been assigned, by using the command [hostname](#) on page 291, this will remain. If however, no host name has been assigned, then the name applied will be the prefix, **host_** followed (without a space) by the MAC address of the device. For example, a device whose MAC address is **0016.76b1.7a5e** will have the name **host_0016_76b1_7a5e** assigned to it.

To efficiently manage your network using AMF, we strongly advise that you devise a naming convention for your network devices, and apply an appropriate hostname to each device in your AMF network.

AMF and STP On AR-Series UTM firewalls and Secure VPN routers, you cannot use STP at the same time as AMF.

- Command List**
- [“application-proxy ip-filter”](#) on page 2502
 - [“application-proxy quarantine-vlan”](#) on page 2503
 - [“application-proxy redirect-url”](#) on page 2504
 - [“application-proxy threat-protection”](#) on page 2505
 - [“application-proxy threat-protection send-summary”](#) on page 2506

- [“application-proxy whitelist advertised-address”](#) on page 2507
- [“application-proxy whitelist enable”](#) on page 2508
- [“application-proxy whitelist protection tls”](#) on page 2509
- [“application-proxy whitelist server”](#) on page 2510
- [“application-proxy whitelist trustpoint \(deprecated\)”](#) on page 2512
- [“area-link”](#) on page 2513
- [“atmf-arealink”](#) on page 2515
- [“atmf-link”](#) on page 2517
- [“atmf area”](#) on page 2518
- [“atmf area password”](#) on page 2520
- [“atmf authorize”](#) on page 2522
- [“atmf authorize provision”](#) on page 2524
- [“atmf backup”](#) on page 2526
- [“atmf backup area-masters delete”](#) on page 2527
- [“atmf backup area-masters enable”](#) on page 2528
- [“atmf backup area-masters now”](#) on page 2529
- [“atmf backup area-masters synchronize”](#) on page 2530
- [“atmf backup bandwidth”](#) on page 2531
- [“atmf backup delete”](#) on page 2532
- [“atmf backup enable”](#) on page 2533
- [“atmf backup guests delete”](#) on page 2534
- [“atmf backup guests enable”](#) on page 2535
- [“atmf backup guests now”](#) on page 2536
- [“atmf backup guests synchronize”](#) on page 2537
- [“atmf backup now”](#) on page 2538
- [“atmf backup redundancy enable”](#) on page 2540
- [“atmf backup server”](#) on page 2541
- [“atmf backup stop”](#) on page 2543
- [“atmf backup synchronize”](#) on page 2544
- [“atmf cleanup”](#) on page 2545
- [“atmf container”](#) on page 2546
- [“atmf container login”](#) on page 2547
- [“atmf controller”](#) on page 2548
- [“atmf distribute firmware”](#) on page 2549
- [“atmf domain vlan”](#) on page 2551

- [“atmf enable”](#) on page 2554
- [“atmf group \(membership\)”](#) on page 2555
- [“atmf guest-class”](#) on page 2557
- [“atmf log-verbose”](#) on page 2559
- [“atmf management subnet”](#) on page 2560
- [“atmf management vlan”](#) on page 2563
- [“atmf master”](#) on page 2565
- [“atmf mtu”](#) on page 2566
- [“atmf network-name”](#) on page 2567
- [“atmf provision \(interface\)”](#) on page 2568
- [“atmf provision node”](#) on page 2569
- [“atmf reboot-rolling”](#) on page 2571
- [“atmf recover”](#) on page 2575
- [“atmf recover guest”](#) on page 2577
- [“atmf recover led-off”](#) on page 2578
- [“atmf recover over-eth”](#) on page 2579
- [“atmf recovery-server”](#) on page 2580
- [“atmf remote-login”](#) on page 2582
- [“atmf restricted-login”](#) on page 2584
- [“atmf retry guest-link”](#) on page 2586
- [“atmf secure-mode”](#) on page 2587
- [“atmf secure-mode certificate expire”](#) on page 2589
- [“atmf secure-mode certificate expiry”](#) on page 2590
- [“atmf secure-mode certificate renew”](#) on page 2591
- [“atmf secure-mode enable-all”](#) on page 2592
- [“atmf select-area”](#) on page 2594
- [“atmf topology-gui enable”](#) on page 2595
- [“atmf trustpoint”](#) on page 2596
- [“atmf virtual-crosslink”](#) on page 2598
- [“atmf virtual-link”](#) on page 2600
- [“atmf virtual-link description”](#) on page 2603
- [“atmf virtual-link protection”](#) on page 2604
- [“atmf working-set”](#) on page 2606
- [“bridge-group \(amf-container\)”](#) on page 2608
- [“clear application-proxy threat-protection”](#) on page 2610

- “clear atmf links” on page 2611
- “clear atmf links virtual” on page 2612
- “clear atmf links statistics” on page 2613
- “clear atmf recovery-file” on page 2614
- “clear atmf secure-mode certificates” on page 2615
- “clear atmf secure-mode statistics” on page 2616
- “clone (amf-provision)” on page 2617
- “configure boot config (amf-provision)” on page 2619
- “configure boot system (amf-provision)” on page 2621
- “copy (amf-provision)” on page 2623
- “create (amf-provision)” on page 2624
- “debug atmf” on page 2626
- “debug atmf packet” on page 2628
- “delete (amf-provision)” on page 2631
- “discovery” on page 2633
- “description (amf-container)” on page 2635
- “erase factory-default” on page 2636
- “http-enable” on page 2637
- “identity (amf-provision)” on page 2639
- “license-cert (amf-provision)” on page 2641
- “locate (amf-provision)” on page 2643
- “log event-host” on page 2645
- “login-fallback enable” on page 2646
- “modeltype” on page 2647
- “service atmf-application-proxy” on page 2648
- “show application-proxy threat-protection” on page 2649
- “show application-proxy whitelist advertised-address” on page 2651
- “show application-proxy whitelist interface” on page 2652
- “show application-proxy whitelist server” on page 2654
- “show application-proxy whitelist supplicant” on page 2655
- “show atmf” on page 2657
- “show atmf area” on page 2661
- “show atmf area guests” on page 2664
- “show atmf area guests-detail” on page 2666
- “show atmf area nodes” on page 2668

- “show atmf area nodes-detail” on page 2670
- “show atmf area summary” on page 2672
- “show atmf authorization” on page 2673
- “show atmf backup” on page 2676
- “show atmf backup area” on page 2680
- “show atmf backup guest” on page 2682
- “show atmf container” on page 2684
- “show atmf detail” on page 2687
- “show atmf group” on page 2689
- “show atmf group members” on page 2691
- “show atmf guests” on page 2693
- “show atmf guests detail” on page 2695
- “show atmf links” on page 2698
- “show atmf links detail” on page 2700
- “show atmf links guest” on page 2709
- “show atmf links guest detail” on page 2711
- “show atmf links statistics” on page 2715
- “show atmf nodes” on page 2718
- “show atmf provision nodes” on page 2720
- “show atmf recovery-file” on page 2722
- “show atmf secure-mode” on page 2723
- “show atmf secure-mode audit” on page 2725
- “show atmf secure-mode audit link” on page 2726
- “show atmf secure-mode certificates” on page 2727
- “show atmf secure-mode sa” on page 2730
- “show atmf secure-mode statistics” on page 2733
- “show atmf tech” on page 2735
- “show atmf virtual-links” on page 2738
- “show atmf working-set” on page 2740
- “show debugging atmf” on page 2741
- “show debugging atmf packet” on page 2742
- “show running-config atmf” on page 2743
- “state” on page 2744
- “switchport atmf-agentlink” on page 2746
- “switchport atmf-arealink” on page 2747

- [“switchport atmf-crosslink”](#) on page 2749
- [“switchport atmf-guestlink”](#) on page 2751
- [“switchport atmf-link”](#) on page 2753
- [“type atmf guest”](#) on page 2754
- [“type atmf node”](#) on page 2755
- [“undebbug atmf”](#) on page 2757
- [“username \(atmf-guest\)”](#) on page 2758

application-proxy ip-filter

Overview Use this command to enable global IP filtering on a device. Once enabled the device will add a global ACL in response to a threat message from an AMF Security (AMF-Sec) Controller.

Use the **no** variant of this command to disable global IP filtering.

Syntax `application-proxy ip-filter`
`no application-proxy ip-filter`

Default Global IP filtering is disabled by default.

Mode Global Configuration

Usage notes For this feature to work, the AMF Application Proxy service needs to be enabled on your network, using the command [service atmf-application-proxy](#).

Example To enable global IP filtering, use the commands:

```
awplus# configure terminal
awplus(config)# application-proxy ip-filter
```

To disable global IP filtering, use the commands:

```
awplus# configure terminal
awplus(config)# no application-proxy ip-filter
```

Related commands [application-proxy redirect-url](#)
[application-proxy threat-protection](#)
[clear application-proxy threat-protection](#)
[service atmf-application-proxy](#)
[show application-proxy threat-protection](#)

Command changes Version 5.4.7-2.5: command added

application-proxy quarantine-vlan

Overview Use this command to set the quarantine VLAN to use when an AMF Security (AMF-Sec) Controller detects a threat. The port/s on which the threat is detected are moved to this VLAN if the [application-proxy threat-protection](#) action is set to **quarantine**.

Use the **no** variant of this command to delete the quarantine VLAN. If no quarantine VLAN is specified then no quarantine action will be performed.

Syntax `application-proxy quarantine-vlan <vlan-id>`
`no application-proxy quarantine-vlan`

Parameter	Description
<code><vlan-id></code>	The ID of the VLAN to use. In the range 1-4094.

Default By default, no quarantine VLAN is configured.

Mode Global Configuration

Example To configure VLAN 100 as the quarantine VLAN, use the commands:

```
awplus# configure terminal  
awplus(config)# application-proxy quarantine-vlan 100
```

To delete the quarantine VLAN, use the commands:

```
awplus# configure terminal  
awplus(config)# no application-proxy quarantine-vlan
```

Related commands [application-proxy threat-protection](#)

[clear application-proxy threat-protection](#)

[application-proxy threat-protection send-summary](#)

[service atmf-application-proxy](#)

[show application-proxy threat-protection](#)

Command changes Version 5.4.7-2.2: command added

application-proxy redirect-url

Overview Use this command to redirect a user to a helpful URL when they are blocked because of an [application-proxy ip-filter](#).

Use the **no** variant of this command to remove the URL redirect.

Syntax `application-proxy redirect-url <url>`
`no application-proxy redirect-url`

Parameter	Description
<code><url></code>	URL to redirect the user to.

Default No URL is configured by default.

Mode Global Configuration

Example To configure a redirect URL, use the command:

```
awplus# application-proxy redirect-url http://my.dom/help.html
```

To remove a redirect URL, use the command:

```
awplus# no application-proxy redirect-url
```

Related commands [application-proxy ip-filter](#)
[application-proxy threat-protection](#)
[clear application-proxy threat-protection](#)
[service atmf-application-proxy](#)
[show application-proxy threat-protection](#)

Command changes Version 5.4.9-0.1: command added

application-proxy threat-protection

Overview Use this command to set the blocking action to take when a threat detected message is received from an AMF Security (AMF-Sec) Controller.

Use the **no** variant of this command to disable threat protection blocking actions on the port.

Syntax application-proxy threat-protection
{drop|link-down|quarantine|log-only}
no application-proxy threat-protection

Parameter	Description
drop	Apply a Layer 2 drop for traffic generating the threat reports.
link-down	Set the link to error disabled in response to threats.
quarantine	Move the offending port to a quarantine VLAN.
log-only	Log when a threat is detected.

Default Threat protection is disabled by default.

Mode Interface Configuration

Example To set the threat protection blocking action on port1.0.4 to drop, use the commands:

```
awplus# configure terminal
awplus(config)# interface port1.0.4
awplus(config-if)# application-proxy threat-protection drop
```

To disable threat protection blocking actions on port1.0.4, use the commands:

```
awplus# configure terminal
awplus(config)# interface port1.0.4
awplus(config-if)# no application-proxy threat-protection
```

Related commands

- [application-proxy quarantine-vlan](#)
- [application-proxy threat-protection send-summary](#)
- [clear application-proxy threat-protection](#)
- [service atmf-application-proxy](#)
- [show application-proxy threat-protection](#)

Command changes

- Version 5.5.2-0.1: added to switch ports on AR series devices
- Version 5.4.9-0.1: **log-only** parameter added
- Version 5.4.7-2.2: command added

application-proxy threat-protection send-summary

Overview Use this command to send a summary of all current threat-protection blocking requests to all AMF Application Proxy service nodes. This command can only be performed on an AMF master.

Syntax `application-proxy threat-protection send-summary`

Mode Privileged Exec

Example To send a summary of all current threat-protection blocking requests to all AMF Application Proxy service nodes, use the command:

```
awplus# application-proxy threat-protection send-summary
```

Related commands

- [application-proxy quarantine-vlan](#)
- [application-proxy threat-protection](#)
- [clear application-proxy threat-protection](#)
- [service atmf-application-proxy](#)
- [show application-proxy threat-protection](#)

Command changes Version 5.4.7-2.2: command added

application-proxy whitelist advertised-address

Overview Use this command to register a Layer 3 interface, and the IPv4 address that is attached to this interface, as the advertised application-proxy whitelist address for a device.

Use the **no** variant of this command to stop advertising the Layer 3 interface and its associated IPv4 address.

Syntax `application-proxy whitelist advertised-address <interface>`
`no application-proxy whitelist advertised-address`

Parameter	Description
<code><interface></code>	Layer 3 interface to configure as the advertised address.

Default No address advertised by default.

Mode Global Configuration

Example To configure the IPv4 address attached to VLAN 1 as the advertised address, use the commands:

```
awplus# configure terminal
awplus(config)# application-proxy whitelist advertised-address
vlan1
```

To remove the advertised address, use the commands:

```
awplus# configure terminal
awplus(config)# no application-proxy whitelist
advertised-address
```

Related commands [application-proxy whitelist server](#)
[show application-proxy whitelist advertised-address](#)

Command changes Version 5.4.9-1.1: command added

application-proxy whitelist enable

Overview Use this command to enable application-proxy whitelist based authentication on an interface.

Use the **no** variant of this command to disable the whitelist authentication.

Syntax application-proxy whitelist enable
no application-proxy whitelist enable

Default Application-proxy whitelist is disabled by default.

Mode Interface Configuration

Usage notes When **port-control** is set to **auto**, the 802.1X authentication feature is executed on the interface, but only if the **aaa authentication dot1x** command has been issued.

If you attempt to change the authentication configuration on an interface that has threat protection quarantine configured, you will see the following error message:

```
% portx.x.x: Application Proxy quarantine configuration must be removed before port authentication is changed
```

Before changing the interface's authentication configuration you must either:

- remove the interface's threat protection configuration, or
- shut down the interface.

Example To enable application-proxy whitelist authentication on the interface port1.0.4, use the commands:

```
awplus# configure terminal
awplus(config)# interface port1.0.4
awplus(config-if)# application-proxy whitelist enable
```

To disable application-proxy whitelist authentication on the interface port1.0.4, use the commands:

```
awplus# configure terminal
awplus(config)# interface port1.0.4
awplus(config-if)# no application-proxy whitelist enable
```

Related commands [application-proxy whitelist server](#)
[show application-proxy whitelist interface](#)
[show application-proxy whitelist server](#)
[show application-proxy whitelist supplicant](#)

Command changes Version 5.4.9-0.1: command added

application-proxy whitelist protection tls

Overview Use this command to configure the application-proxy whitelist control channel to use TLS protection. If no trustpoint is specified then TLS will operate without authentication.

Use the **no** variant of this command to stop using TLS.

Syntax `application-proxy whitelist protection tls [trustpoint <name>]`
`no application-proxy whitelist protection tls`

Parameter	Description
<code>trustpoint</code>	Specify an optional trustpoint. If no trustpoint is specified then TLS will operate without authentication.
<code><name></code>	Name of the trustpoint.

Default TLS is disabled by default.

Mode Global Configuration

Example To configure an AMF application-proxy whitelist to use TLS with the trustpoint 'corpca', use the commands:

```
awplus# configure terminal
awplus(config)# application-proxy whitelist protection tls
trustpoint corpca
```

To configure an AMF application-proxy whitelist to stop using TLS, use the commands:

```
awplus# configure terminal
awplus(config)# no application-proxy whitelist protection tls
```

Related commands [application-proxy whitelist enable](#)
[application-proxy whitelist server](#)
[show application-proxy whitelist server](#)

Command changes Version 5.5.0-2.1: command added

application-proxy whitelist server

Overview Use this command to set an AMF master to act as a whitelist authentication proxy between AMF members, acting as Network Access Servers, and an external whitelist RADIUS server.

Use the **no** variant of this command to disable the whitelist proxy functionality.

Syntax `application-proxy whitelist server <ip-address> key <key>`
`[auth-port <1-65535>]`
`no application-proxy whitelist server`

Parameter	Description
<code><ip-address></code>	IPv4 address of the upstream RADIUS server in dotted decimal format A.B.C.D.
<code>key <key></code>	Set the shared secret encryption key for communication with the upstream RADIUS server.
<code>auth-port <1-65535></code>	Set the RADIUS server UDP port. This is only necessary if you don't want to use the default port 1812.

Default Disabled by default.

Mode Global Configuration

Example To configure an AMF master to work as a proxy to the external RADIUS server 192.168.1.10, with shared secret 'mysecurekey', on port 1822, use the commands:

```
awplus# configure terminal
awplus(config)# application-proxy whitelist server 192.168.1.10
key mysecurekey auth-port 1822
```

To configure an AMF master to work as a proxy to the external RADIUS server 192.168.1.10, with shared secret 'mysecurekey', on the default port (1812), use the commands:

```
awplus# configure terminal
awplus(config)# application-proxy whitelist server 192.168.1.10
key mysecurekey
```

To disable the whitelist proxy, use the commands:

```
awplus# configure terminal
awplus(config)# no application-proxy whitelist server
```

Related commands

- [application-proxy whitelist enable](#)
- [service atmf-application-proxy](#)
- [show application-proxy whitelist interface](#)
- [show application-proxy whitelist server](#)

show application-proxy whitelist supplicant

Command changes Version 5.4.9-0.1: command added

application-proxy whitelist trustpoint (deprecated)

Overview This command has been deprecated. It has been replaced by the [application-proxy whitelist protection tls](#) command.

This command sets the trustpoint to use when communicating with the external whitelist RADIUS server. This enables RADIUS over TLS (RadSec) protection.

Syntax `application-proxy whitelist trustpoint <name>`
`no application-proxy whitelist trustpoint`

Command changes Version 5.4.9-1.1: command added
Version 5.5.0-2.1: command deprecated

area-link

Overview Use this command to create an area-link between a Virtual AMF Appliance (VAA) host controller and an AMF container.

An AMF container is an isolated instance of AlliedWare Plus with its own network interfaces, configuration, and file system. The features available inside an AMF container are a sub-set of the features available on the host VAA. These features enable the AMF container to function as a uniquely identifiable AMF master and allows for multiple tenants (up to 60) to run on a single VAA host. See the [AMF Feature Overview and Configuration Guide](#) for more information on running multiple tenants on a single VAA host.

Use the **no** variant of this command to remove an area-link from a container.

Syntax `area-link <area-name>`
`no area-link`

Parameter	Description
<code><area-name></code>	AMF area name of the container's area.

Mode AMF Container Configuration

Usage notes The AMF area-link connects the AMF controller on a VAA host to the AMF container. Once a container has been created with the [atmf container](#) command and an area-link configured with the **area-link** command, it can be enabled using the [state](#) command.

You can only configure a single area-link on a container. You will see the following message if you try and configure a second one:

```
% AreaLink already configured for this container
```

Each container has two virtual interfaces:

- Interface eth0, used to connect to the AMF controller on the VAA host via an AMF area-link, configured using this area-link command.
- Interface eth1, used to connect to the outside world using a bridged L2 network link, configured using the [bridge-group \(amf-container\)](#) command.

See the [AMF Feature Overview and Configuration_Guide](#) for more information on these virtual interfaces and links.

Example To create the area-link to "wlg" on container "vac-wlg-1", use the commands:

```
awplus# configure terminal
awplus(config)# atmf container vac-wlg-1
awplus(config-atmf-container)# area-link wlg
```

To remove an area-link from container “vac-wlg-1”, use the commands:

```
awplus# configure terminal
awplus(config)# atmf container vac-wlg-1
awplus(config-atmf-container)# no area-link
```

**Related
commands**

[atmf container](#)
[show atmf container](#)

**Command
changes**

Version 5.4.7-0.1: command added

atmf-arealink

Overview This command to enable an Eth interface, on an AR-series device, as an AMF area link. AMF area links are designed to operate between two nodes in different areas in an AMF network. This command is only available if your network is running in AMF secure mode (see [atmf secure-mode](#) for more information on AMF secure mode).

Use the **no** variant of this command to remove any AMF area links that may exist for the selected Eth interface.

Syntax `atmf-arealink remote-area <area-name> vlan <2-4094>`
`no atmf-arealink`

Parameter	Description
<area-name>	The name of the remote area that the interface is connecting to.
<2-4094>	The VLAN ID for the link. This VLAN cannot be used for any other purpose, and the same VLAN ID must be used at each end of the link.

Default By default, no area links are configured

Mode Eth interface on an AR-series device.

Usage notes Run this command on the interface at both ends of the link.

Each area must have the area-name configured, and the same area password must exist on both ends of the link.

Running this command will synchronize the area information stored on the two nodes.

You can configure multiple area links between two area nodes, but only one area link at any time will be in use. All other area links will block information, to prevent network storms.

NOTE: See the [switchport atmf-arealink](#) command to configure an AMF area link on an a switch port or link aggregator

Example To configure eth1 as an AMF area link to the 'Auckland' area on VLAN 6, use the following commands:

```
master_1# configure terminal
master_1(config)# interface eth1
master_1(config-if)# atmf-arealink remote-area Auckland vlan 6
```

To remove eth1 as an AMF area link, use the following commands:

```
master_1# configure terminal
master_1(config)# interface eth1
master_1(config-if)# no atmf-arealink
```

Related commands [atmf area](#)
[atmf area password](#)
[atmf virtual-link](#)
[show atmf links](#)

Command changes Version 5.5.0-1.1: command added

atmf-link

Overview Use this command to enable an Eth interface on an AR-series device as an up/down AMF link. This command is only available if your network is running in AMF secure mode (see [atmf secure-mode](#) for more information on AMF secure mode).

Use the **no** variant of this command to remove any AMF link that may exist for the selected Eth interface.

Syntax atmf-link
no atmf-link

Mode Eth interface on an AR-series device.

Usage notes Up/down links and virtual links interconnect domains in a vertical hierarchy, with the highest domain being the core domain. In effect, they form a tree of interconnected AMF domains. This tree must be loop-free. Therefore you must configure your up/down and virtual links so that no loops are formed.

If you run the command and AMF secure mode is not enabled, you will see the following error message:

```
Node_1(config)#int eth1
Node_1(config-if)#atmf-link
% Cannot configure eth1 because atmf secure-mode is not enabled.
```

NOTE: See the [switchport atmf-link](#) command to configure an AMF up/down link on an a switch port or link aggregator

Example To configure eth1 as an AMF up/down link, use the following commands:

```
Node_1# configure terminal
Node_1(config)# interface eth1
Node_1(config-if)# atmf-link
```

To remove eth1 as an AMF up/down link, use the following commands:

```
Node_1# configure terminal
Node_1(config)# interface eth1
Node_1(config-if)# no atmf-link
```

Related commands [atmf recover over-eth](#)
[atmf secure-mode](#)
[show atmf detail](#)
[show atmf links](#)
[switchport atmf-link](#)

Command changes Version 5.5.0-1.1: command added

atmf area

Overview This command creates an AMF area and gives it a name and ID number. Use the **no** variant of this command to remove the AMF area. This command is only valid on AMF controllers, master nodes and gateway nodes.

Syntax `atmf area <area-name> id <1-4094> [local]`
`no atmf area <area-name>`

Parameter	Description
<area-name>	The AMF area name. The area name can be up to 15 characters long. Valid characters are: a..z A..Z 0..9 - _ Names are case sensitive and must be unique within an AMF network. The name cannot be the word "local" or an abbreviation of the word "local" (such as "l", "lo" etc.).
<1-4094>	An ID number that uniquely identifies this area.
local	Set the area to be the local area. The local area contains the device you are configuring.

Mode Global Configuration

Usage notes This command enables you to divide your AMF network into areas. Each area is managed by at least one AMF master node. Each area can have up to 120 nodes, depending on the license installed on that area's master node.

The whole AMF network is managed by up to 8 AMF controllers. Each AMF controller can communicate with multiple areas. The number of areas supported on a controller depends on the license installed on that controller.

You must give each area in an AMF network a unique name and ID number.

Only one local area can be configured on a device. You must specify a local area on each controller, remote AMF master, and gateway node.

Example To create the AMF area named New-Zealand, with an ID of 1, and specify that it is the local area, use the command:

```
controller-1(config)# atmf area New-Zealand id 1 local
```

To configure a remote area named Auckland, with an ID of 100, use the command:

```
controller-1(config)# atmf area Auckland id 100
```

Related commands

- atmf area password
- show atmf area
- show atmf area summary
- show atmf area nodes
- switchport atmf-arealink

Command changes Version 5.5.1-2.1: area **id** maximum increased to 4094

atmf area password

Overview This command sets a password on an AMF area.

Use the **no** variant of this command to remove the password.

This command is only valid on AMF controllers, master nodes and gateway nodes. The area name must have been configured first.

Syntax `atmf area <area-name> password [8] <password>`
`no atmf area <area-name> password`

Parameter	Description
<area-name>	The AMF area name.
8	This parameter is displayed in show running-config output to indicate that it is displaying the password in encrypted form. You should not enter 8 on the CLI yourself.
<password>	The password is between 8 and 32 characters long. It can include spaces.

Mode Global Configuration

Usage notes You must configure a password on each area that an AMF controller communicates with, except for the controller's local area. The areas must already have been created using the `atmf area` command.

Enter the password identically on both of:

- the area that locally contains the controller, and
- the remote AMF area masters

The command **show running-config atmf** will display the encrypted version of this password. The encryption keys will match between the controller and the remote AMF master.

If multiple controller and masters exist in an area, they must all have the same area configuration.

Example To give the AMF area named *Auckland* a password of "secure#1" use the following command on the controller:

```
controller-1(config)# atmf area Auckland password secure#1
```

and also use the following command on the master node for the Auckland area:

```
auck-master(config)# atmf area Auckland password secure#1
```

Related commands

- atmf area
- show atmf area
- show atmf area summary
- show atmf area nodes
- switchport atmf-arealink

atmf authorize

Overview On an AMF network, with secure mode enabled, use this command on an AMF master to authorize an AMF node to join the network. AMF nodes waiting to be authorized appear in the pending authorization queue, which can be examined using the [show atmf authorization](#) command with the **pending** parameter.

Use the **no** variant of this command to revoke authorization for an AMF node on an AMF master.

Syntax `atmf authorize {<node-name> [area <area-name>]|all-pending}`
`no atmf authorize <node-name> [area <area-name>]`

Parameter	Description
<node-name>	The name of the node to be authorized or have its authorization revoked.
area	Specify an AMF area.
<area-name>	This is the name of the area the node belongs to.
all-pending	Authorize all nodes in the pending queue.

Mode Privileged Exec

Usage notes On an AMF controller, AMF remote-area masters must be authorized by the controller, and the AMF remote-area masters will also need to authorized access from the AMF controller.

Example To authorize all AMF nodes in the pending authorization queue on an AMF master, use the command:

```
awplus# atmf authorize all-pending
```

To authorize a node called "node2" in remote AMF area "area3", use the command:

```
awplus# atmf authorize node2 area "area3"
```

To authorize a node called "node4" on an AMF master, use the command:

```
awplus# atmf authorize node4
```

To revoke authorization for a node called "node4" on an AMF master, use the command:

```
awplus# no atmf authorize node4
```

Related commands [atmf secure-mode](#)
[clear atmf secure-mode certificates](#)
[show atmf authorization](#)
[show atmf secure-mode](#)

show atmf secure-mode certificates

show atmf secure-mode statistics

Command changes Version 5.4.7-0.3: command added

atmf authorize provision

Overview Use this command from an AMF controller or AMF master to pre-authorize a node on an AMF network running in secure mode. This allows a node to join the AMF network the moment the `atmf secure-mode` command is run on that node.

Use the **no** variant of this command to remove a provisional authorization from and AMF controller or AMF master.

Syntax

```
atmf authorize provision [timeout <minutes>] node <node-name>
interface <interface-name> [area <area-name>]

atmf authorize provision [timeout <minutes>] mac <mac-address>

atmf authorize provision [timeout <minutes>] all

no atmf authorize provision node <node-name> interface
<interface-name> [area <area-name>]

no atmf authorize provision mac <mac-address>

no atmf authorize provision all
```

Parameter	Description
timeout	Timeout for provisional authorization. Authorization for provisioned nodes expires after the timeout period specified.
<minutes>	Timeout in minutes. A value between 1 and 6000 is permissible with the default being 60 minutes.
node	Specify a node to provision by node name.
<node-name>	The name of the node to provisionally authorize.
interface	Specify the interface the node will connect on.
<interface-name>	The name of the interface, this can be a switchport, link aggregator, LACP link, or virtual link.
area	Specify the AMF area.
<area-name>	This is the name of the area the node belongs to.
mac	Specify a node to provision by MAC address.
<mac-address>	Enter a MAC address to provisionally authorize in the format HHHH.HHHH.HHHH.
all	Provision authorization for all secure mode capable nodes.

Default The default timeout is 60 minutes.

Mode Privileged Exec

Example To provisionally authorize all non-secure AMF nodes, use the command:

```
awplus# atmf authorize provision all
```

To authorize a node with a MAC address of 0000.cd28.0880 for 2 hours, use the command:

```
awplus# authorize provision timeout 120 mac 0000.cd28.0880
```

To remove all provisional authorization, on an AMF master, use the command:

```
awplus# no atmf authorize provision all
```

Related commands [show atmf authorization](#)
[show atmf secure-mode](#)

Command changes Version 5.4.7-0.3: command added

atmf backup

Overview This command can only be applied to a master node. It manually schedules an AMF backup to start at a specified time and to execute a specified number of times per day.

Use the **no** variant of this command to disable the schedule.

Syntax `atmf backup {default|<hh:mm> frequency <1-24>}`

Parameter	Description
default	Restore the default backup schedule.
<hh:mm>	Sets the time of day to apply the first backup, in hours and minutes. Note that this parameter uses the 24 hour clock.
backup	Enables AMF backup to external media.
frequency <1-24>	Sets the number of times within a 24 hour period that backups will be taken.

Default Backups run daily at 03:00 AM, by default

Mode Global Configuration

Usage notes Running this command only configures the schedule. To enable the schedule, you should then apply the command [atmf backup enable](#).

We recommend using the ext3 or ext4 filesystem on external media that are used for AMF backups.

Example To schedule backup requests to begin at 11 am and execute twice per day (11 am and 11 pm), use the following command:

```
node_1# configure terminal
node_1(config)# atmf backup 11:00 frequency 2
```

CAUTION: File names that comprise identical text, but with differing case, such as *Test.txt* and *test.txt*, will not be recognized as being different on FAT32 based backup media such as a USB storage device. However, these filenames will be recognized as being different on your Linux based device. Therefore, for good practice, ensure that you apply a consistent case structure for your back-up file names.

Related commands

- [atmf backup enable](#)
- [atmf backup stop](#)
- [show atmf backup](#)

atmf backup area-masters delete

Overview Use this command to delete from external media, a backup of a specified node in a specified area.

Note that this command can only be run on an AMF controller.

Syntax `atmf backup area-masters delete area <area-name> node <node-name>`

Parameter	Description
<code><area-name></code>	The area that contains the node whose backup will be deleted.
<code><node-name></code>	The node whose backup will be deleted.

Mode Privileged Exec

Example To delete the backup of the remote area-master named “well-gate” in the AMF area named Wellington, use the command:

```
controller-1# atmf backup area-masters delete area Wellington  
node well-gate
```

Related commands [show atmf backup area](#)

atmf backup area-masters enable

Overview Use this command to enable backup of remote area-masters from the AMF controller. This command is only valid on AMF controllers.

Use the **no** form of the command to stop backups of remote area-masters.

Syntax `atmf backup area-masters enable`
`no atmf backup area-masters enable`

Mode Global configuration

Default Remote area backups are disabled by default

Usage notes Use the following commands to configure the remote area-master backups:

- [atmf backup](#) to configure when the backups begin and how often they run
- [atmf backup server](#) to configure the backup server.

We recommend using the ext3 or ext4 filesystem on external media that are used for AMF backups.

Example To enable scheduled backups of AMF remote area-masters, use the commands:

```
controller-1# configure terminal
controller-1(config)# atmf backup area-masters enable
```

To disable scheduled backups of AMF remote area-masters, use the commands:

```
controller-1# configure terminal
controller-1(config)# no atmf backup area-masters enable
```

Related commands [atmf backup server](#)
[atmf backup](#)
[show atmf backup area](#)

atmf backup area-masters now

Overview Use this command to run an AMF backup of one or more remote area-masters from the AMF controller immediately.

This command is only valid on AMF controllers.

Syntax `atmf backup area-masters now [area <area-name>|area <area-name>
node <node-name>]`

Parameter	Description
<area-name>	The area whose area-masters will be backed up.
<node-name>	The node that will be backed up.

Mode Privileged Exec

Example To back up all local master nodes in all areas controlled by controller-1, use the command

```
controller-1# atmf backup area-masters now
```

To back up all local masters in the AMF area named Wellington, use the command

```
controller-1# atmf backup area-masters now area Wellington
```

To back up the local master "well-master" in the Wellington area, use the command

```
controller-1# atmf backup area-masters now area Wellington node  
well-master
```

Related commands [atmf backup area-masters enable](#)
[atmf backup area-masters synchronize](#)
[show atmf backup area](#)

atmf backup area-masters synchronize

Overview Use this command to synchronize backed-up area-master files between the active remote file server and the backup remote file server. Files are copied from the active server to the remote server.

Note that this command is only valid on AMF controllers.

Syntax `atmf backup area-masters synchronize`

Mode Privileged Exec

Example To synchronize backed-up files between the remote file servers for all area-masters, use the command:

```
controller-1# atmf backup area-masters synchronize
```

Related commands

- [atmf backup area-masters enable](#)
- [atmf backup area-masters now](#)
- [show atmf backup area](#)

atmf backup bandwidth

Overview This command sets the maximum bandwidth in kilobytes per second (kBps) available to the AMF backup process. This command enables you to restrict the bandwidth that is utilized for downloading file contents during a backup.

NOTE: *This command will only run on an AMF master. An error message will be generated if the command is attempted on node that is not a master.*

Also note that setting the bandwidth value to zero will allow the transmission of as much bandwidth as is available, which can exceed the maximum configurable speed of 1000 kBps. In effect, zero means unlimited.

Use the **no** variant of this command to reset (to its default value of zero) the maximum bandwidth in kilobytes per second (kBps) available when initiating an AMF backup. A value of zero tells the backup process to transfer files using unlimited bandwidth.

Syntax `atmf backup bandwidth <0-1000>`
`no atmf backup bandwidth`

Parameter	Description
<code><0-1000></code>	Sets the bandwidth in kilobytes per second (kBps)

Default The default value is zero, allowing unlimited bandwidth when executing an AMF backup.

Mode Global Configuration

Examples To set an atmf backup bandwidth of 750 kBps, use the commands:

```
node2# configure terminal
node2(config)# atmf backup bandwidth 750
```

To set the AMF backup bandwidth to the default value for unlimited bandwidth, use the commands:

```
node2# configure terminal
node2(config)# no atmf backup bandwidth
```

Related commands [show atmf backup](#)

atmf backup delete

Overview This command removes the backup file from the external media of a specified AMF node.

Note that this command can only be run from an AMF master node.

Syntax `atmf backup delete <node-name>`

Parameter	Description
<code><node-name></code>	The AMF node name of the backup file to be deleted.

Mode Privileged Exec

Example To delete the backup file from node2, use the following command:

```
Node_1# atmf backup delete node2
```

Related commands

- `show atmf backup`
- `atmf backup now`
- `atmf backup stop`

atmf backup enable

Overview This command enables automatic AMF backups on the AMF master node that you are connected to. By default, automatic backup starts at 3:00 AM. However, this schedule can be changed by the [atmf backup](#) command. Note that backups are initiated and stored only on the master nodes.

Use the **no** variant of this command to disable any AMF backups that have been scheduled and previously enabled.

Syntax `atmf backup enable`
`no atmf backup enable`

Default Automatic AMF backup functionality is enabled on the AMF master when it is configured and external media, i.e. an SD card or a USB storage device or remote server, is detected.

Mode Global Configuration

Usage notes A warning message will appear if you run the [atmf backup enable](#) command with either insufficient or marginal memory availability on your external storage device.

You can use the command [show atmf backup](#) on page 2676 to check the amount of space available on your external storage device.

We recommend using the ext3 or ext4 filesystem on external media that are used for AMF backups.

Example To turn on automatic AMF backup, use the following command:

```
AMF_Master_1# configure terminal
AMF_Master_1(config)# atmf backup enable
```

Related commands [show atmf](#)
[show atmf backup](#)
[atmf backup](#)
[atmf backup now](#)
[atmf enable](#)

atmf backup guests delete

Overview This command removes a guest node's backup files from external media such as a USB drive, SD card, or an external file server.

Syntax `atmf backup guests delete <node-name> <guest-port>`

Parameter	Description
<code><node-name></code>	The name of the guest's parent node.
<code><guest-port></code>	The port number on the parent node.

Mode User Exec/Privileged Exec

Example On a parent node named "node1" (which, in this case, the user has a direct console connection to) use the following command to remove the backup files of the guest node that is directly connected to port1.0.3.

```
node1# atmf backup guests delete node1 port1.0.3
```

Related Command

- [atmf backup delete](#)
- [atmf backup area-masters delete](#)
- [show atmf backup guest](#)

atmf backup guests enable

Overview Use this command to enable backups of remote guest nodes from an AMF master. Use the **no** variant of this command to disable the ability of the guest nodes to be backed up.

Syntax `atmf backup guests enable`
`no atmf backup guests enable`

Default Guest node backups are enabled by default.

Mode Global Config

Usage notes We recommend using the ext3 or ext4 filesystem on external media that are used for AMF backups.

Example On the AMF master node, enable all scheduled guest node backups:

```
atmf-master# configure terminal
atmf-master(config)# atmf backup guests enable
```

Related commands `atmf backup area-masters enable`
`show atmf backup guest`
`atmf backup guests synchronize`

atmf backup guests now

Overview This command manually triggers an AMF backup of guest nodes on a AMF Master.

Syntax `atmf backup guests now [<node-name>] [<guest-port>]`

Parameter	Description
<code><node-name></code>	The name of the guest's parent node.
<code><guest-port></code>	The port number that connects to the guest node.

Default n/a

Mode Privileged Exec

Example Use the following command to manually trigger the backup of all guests in the AMF network

```
awplus# atmf backup guests now
```

Example To manually trigger the backup of a guest node connected to port 1.0.23 of node1, use the following command:

```
awplus# atmf backup guests now node1 port1.0.23
```

Related commands [show atmf backup guest](#)

atmf backup guests synchronize

Overview This command initiates a manual synchronization of all guest backup file-sets across remote file servers and various redundancy backup media, such as USB storage devices. This facility ensures that each device contains the same backup image files. Note that this backup synchronization process will occur as part of the regular backups scheduled by the [atmf backup](#) command.

Syntax `atmf backup guests synchronize`

Default n/a

Mode User Exec/Privileged Exec

Example To synchronize backups across remote file servers and storage devices, use the command:

```
Node1#atmf backup guests synchronize
```

Related commands [atmf backup redundancy enable](#)
[show atmf guests](#)
[atmf backup guests enable](#)

atmf backup now

Overview This command initiates an immediate AMF backup of either all AMF members, or a selected AMF member. Note that this backup information is stored in the external media on the master node of the device on which this command is run, even though the selected AMF member may not be a master node.

Note that this command can only be run on an AMF master node.

Syntax `atmf backup now [<nodename>]`

Parameter	Description
<nodename> or <hostname>	The name of the AMF member to be backed up, as set by the command <code>hostname</code> on page 291. Where no name has been assigned to this device, then you must use the default name, which is the word "host", then an underscore, then (without a space) the MAC address of the device to be backed up. For example <code>host_0016_76b1_7a5e</code> . Note that the node-name appears as the command Prompt when in Privileged Exec mode.

Default A backup is initiated for all nodes on the AMF (but stored on the master nodes).

Mode Privileged Exec

Usage notes Although this command will select the AMF node to be backed-up, it can only be run from any AMF master node.

NOTE: *The backup produced will be for the selected node but the backed-up config will reside on the external media of the AMF master node on which the command was run. However, this process will result in the information on one master being more up-to-date. To maintain concurrent backups on both masters, you can apply the backup now command to the master working-set. This is shown in Example 4 below.*

Example 1 In this example, an AMF member has not been assigned a host name. The following command is run on the AMF_Master_2 node to immediately backup the device that is identified by its MAC address of 0016.76b1.7a5e:

```
AMF_Master_2# atmf backup now host_0016_76b1_7a5e
```

NOTE: *When a host name is derived from its MAC address, the syntax format entered changes from XXXX.XXXX.XXXX to XXXX_XXXX_XXXX.*

Example 2 In this example, an AMF member has the host name, **office_annex**. The following command will immediately backup this device:

```
AMF_Master_2# atmf backup now office_annex
```

This command is initiated on the device's master node named **AMF_Master_2** and initiates an immediate backup on the device named **office_annex**.

Example 3 To initiate from AMF_master_1 an immediate backup of all AMF member nodes, use the following command:

```
AMF_Master_1# amf backup now
```

Example 4 To initiate an immediate backup of the node with the host-name “office_annex” and store the configuration on both masters, use the following process:

From the AMF_master_1, set the working-set to comprise only of the automatic group, master nodes.

```
AMF_Master_1# atmf working-set group master
```

This command returns the following display:

```
=====
AMF_Master_1, AMF_Master_2
=====

Working set join
```

Backup the AMF member with the host name, **office_annex** on both the master nodes as defined by the working set.

```
AMF_Master[2]# atmf backup now office_annex
```

Note that the [2] shown in the command prompt indicates a 2 node working-set.

Related commands

- [atmf backup](#)
- [atmf backup stop](#)
- [hostname](#)
- [show atmf backup](#)

atmf backup redundancy enable

Overview This command is used to enable or disable AMF backup redundancy.

Syntax `atmf backup redundancy enable`
`no atmf backup redundancy enable`

Default Disabled

Mode Global Configuration

Usage notes If the AMF Master or Controller supports any removable media (SD card/USB), it uses the removable media as the redundant backup for the AMF data backup.

This feature is valid only if remote file servers are configured on the AMF Master or Controller.

We recommend using the ext3 or ext4 filesystem on external media that are used for AMF backups.

Example To enable AMF backup redundancy, use the commands:

```
awplus# configure terminal
awplus(config)# atmf backup redundancy enable
```

To disable AMF backup redundancy, use the commands:

```
awplus# configure terminal
awplus(config)# no atmf backup redundancy enable
```

Related commands [atmf backup synchronize](#)
[show atmf backup](#)
[show atmf backup area](#)

atmf backup server

Overview This command configures remote file servers as the destination for AMF backups.

Use the **no** variant of this command to remove the destination server(s). When all servers are removed the system will revert to backup from external media.

Syntax `atmf backup server id {1|2} <hostlocation> username <username>
[path <path>|port <1-65535>]`
`no atmf backup server id {1|2}`

Parameter	Description
id	Remote server backup server identifier.
{1 2}	The backup server identifier number (1 or 2). Note that there can be up to two backup servers, numbered 1 and 2 respectively, and you would need to run this command separately for each server.
<hostlocation>	Either the name or the IP address (IPv4 or IPv6) of the selected backup server (1 or 2).
username	Configure the username to log in with on the selected remote file server.
<username>	The selected remote file server's username.
path	The location of the backup files on the selected remote file server. By default this will be the home directory of the username used to log in with.
<path>	The directory path utilized to store the backup files on the selected remote file server. No spaces are allowed in the path.
port	The connection to the selected remote backup file server using SSH. By default SSH connects to a device on TCP port 22 but this can be changed with this command.
<1-65535>	A TCP port within the specified range.

Defaults Remote backup servers are not configured. The default SSH TCP port is 22. The path utilized on the remote file server is the home directory of the username.

Mode Global Exec

Usage notes The hostname and username parameters must both be configured.

Examples To configure server 1 with an IPv4 address and a username of *backup1*, use the commands:

```
AMF_Master_1# configure terminal
AMF_Master_1(config)# atmf backup server id 1 192.168.1.1
username backup1
```

To configure server 1 with an IPv6 address and a username of *backup1*, use the command:

```
AMF_backup1_1# configure terminal
AMF_Master_1(config)# atmf backup server id 1 FFEE::01 username
backup1
```

To configure server 2 with a hostname and username, use the command:

```
AMF_Master_1# configure terminal
AMF_Master_1(config)# atmf backup server id 2 www.example.com
username backup2
```

To configure server 2 with a hostname and username in addition to the optional path and port parameters, use the command:

```
AMF_Master_1# configure terminal
AMF_Master_1(config)# atmf backup server id 2 www.example.com
username backup2 path tokyo port 1024
```

To unconfigure the AMF remote backup file server 1, use the command:

```
AMF_Master_1# configure terminal
AMF_Master_1(config)# no atmf backup server id 1
```

Related commands [show atmf backup](#)

atmf backup stop

Overview Running this command stops a backup that is currently running on the master node you are logged onto. Note that if you have two masters and want to stop both, then you can either run this command separately on each master node, or add both masters to a working set, and issue this command to the working set.

Note that this command can only be run on a master node.

Syntax `atmf backup stop`

Mode Privileged Exec

Usage notes This command is used to halt an AMF backup that is in progress. In this situation the backup process will finish on its current node and then stop.

Example To stop a backup that is currently executing on master node node-1, use the following command:

```
AMF_Master_1# amf backup stop
```

Related commands

- [atmf backup](#)
- [atmf backup enable](#)
- [atmf backup now](#)
- [show atmf backup](#)

atmf backup synchronize

Overview For the master node you are connected to, this command initiates a system backup of files from the node's active remote file server to its backup remote file server. Note that this process happens automatically each time the network is backed up.

Note that this command can only be run from a master node.

Syntax `atmf backup synchronize`

Mode Privileged Exec

Example When connected to the master node `AMF_Master_1`, the following command will initiate a backup of all system related files from its active remote file server to its backup remote file server.

```
AMF_Master_1# atmf backup synchronize
```

Related commands

- [atmf backup enable](#)
- [atmf backup redundancy enable](#)
- [show atmf](#)
- [show atmf backup](#)

atmf cleanup

Overview This command is an alias to the [erase factory-default](#) command.

atmf container

Overview Use this command to create or update an AMF container on a Virtual AMF Appliance (VAA) virtual machine.

An AMF container is an isolated instance of AlliedWare Plus with its own network interfaces, configuration, and file system. The features available inside an AMF container are a sub-set of the features available on the host VAA. These features enable the AMF container to function as a uniquely identifiable AMF master and allows for multiple tenants (up to 60) to run on a single VAA host. See the [AMF Feature Overview and Configuration Guide](#) for more information on running multiple tenants on a single VAA host.

Use the **no** variant of this command to remove an AMF container.

Syntax `atmf container <container-name>`
`no atmf container <container-name>`

Parameter	Description
<code><container-name></code>	The name of the AMF container to create, update, or remove.

Mode AMF Container Configuration

Usage notes You cannot delete a container while it is still running. First use the **state disable** command to stop the container.

Examples To create or update the AMF container "vac-wlg-1", use the commands:

```
awplus# configure terminal
awplus(config)# atmf container vac-wlg-1
awplus(config-atmf-container)#
```

To remove the AMF container "vac-wlg-1", use the commands:

```
awplus# configure terminal
awplus(config)# no atmf container vac-wlg-1
```

Related commands

- [area-link](#)
- [atmf container login](#)
- [bridge-group \(amf-container\)](#)
- [description \(amf-container\)](#)
- [show atmf container](#)
- [state](#)

Command changes Version 5.4.7-0.1: command added

atmf container login

Overview Use this command to login to an AMF container on a Virtual AMF Appliance (VAA).

An AMF container is an isolated instance of AlliedWare Plus with its own network interfaces, configuration, and file system. The features available inside an AMF container are a sub-set of the features available on the host VAA. These features enable the AMF container to function as a uniquely identifiable AMF master and allows for multiple tenants (up to 60) to run on a single VAA host. See the [AMF Feature Overview and Configuration Guide](#) for more information on running multiple tenants on a single VAA host.

Syntax `atmf container login <container-name>`

Parameter	Description
<code><container-name></code>	The name of the AMF container you wish to login into.

Mode Privileged Exec

Usage notes If you try to login to a AMF container that has not been created, or is not running, you will see the following message:

```
% Container does not exist or is not running.
```

To exit from a container and return to the host VAA press `<Ctrl+a q>`.

Example To login to container “vac-wlg-1”, use the command:

```
awplus# atmf container login vac-wlg-1
```

You will then be presented with a login screen for that container:

```
Connected to tty 1
Type <Ctrl+a q> to exit the console, <Ctrl+a Ctrl+a> to enter Ctrl+a itself

vac-wlg-1 login: manager
Password: friend

AlliedWare Plus (TM) 5.4.7 02/03/17 08:46:12

vac-wlg-1>
```

Related commands [atmf container](#)
[show atmf container](#)

Command changes Version 5.4.7-0.1: command added

atmf controller

Overview Use this command to configure the device as an AMF controller. This enables you to split a large AMF network into multiple areas.

AMF controller is a licensed feature. The number of areas supported on a controller depends on the license installed on that controller.

Use the **no** variant of this command to remove the AMF controller functionality.

Syntax `atmf controller`
`no atmf controller`

Mode Global configuration

Usage notes If a valid AMF controller license is not available on the device, the device will accept this command but will not act as a controller until you install a valid license. The following message will warn you of this:

“An AMF Controller license must be installed before this feature will become active”

NOTE: *If the AMF controller functionality is removed from a device using the **no atmf controller** command then the device must be rebooted if it is to function properly as an AMF master.*

Example To configure the node named *controller-1* as an AMF controller, use the commands:

```
controller-1# configure terminal
controller-1(config)# atmf controller
```

To stop the node named *controller-1* from being an AMF controller, use the commands:

```
controller-1# configure terminal
controller-1(config)# no atmf controller
```

Related commands [atmf area](#)
[show atmf](#)

atmf distribute firmware

Overview This command can be used to upgrade software one AMF node at a time. A URL can be selected from any media location. The latest compatible release for a node will be selected from this location.

Several procedures are performed to ensure the upgrade will succeed. This includes checking the current node release boots from flash. If there is enough space on flash, the software release is copied to flash on the new location.

The new release name is updated using the **boot system** command. The old release will become the backup release file. If a release file exists in a remote device (such as TFTP or HTTP, for example) then the URL should specify the exact release filename without using a wild card character.

The command will continue to upgrade software until all nodes are upgraded. At the end of the upgrade cycle the command should be used on the working-set.

Syntax `atmf distribute firmware <filename>`

Parameter	Description
<code><filename></code>	The filename and path of the file. See the File Management Feature Overview and Configuration Guide for valid syntax.

Mode Privileged Exec

Examples To upgrade nodes in a AMF network with a predefined AMF group called 'teams', use the following command:

```
Team1# atmf working-set group teams
```

```
=====
Team1, Team2, Team3:
=====
Working set join
```

```
ATMF_NETWORK[3]# atmf distribute firmware card:*.rel
```

```
Retrieving data from Team1
Retrieving data from Team2
Retrieving data from Team3

ATMF Firmware Upgrade:

Node Name           New Release File           Status
-----
Team1                x510-5.4.7-1.1.rel         Release ready
Team2                x930-5.4.7-1.1.rel         Release ready
Team3                x930-5.4.7-1.1.rel         Release ready
Continue the rolling reboot ? (y/n):y
=====
Copying Release      : x510-5.4.7-1.1.rel to Team1
Updating Release     : x510-5.4.7-1.1.rel information on Team1
=====
Copying Release      : x930-5.4.7-1.1.rel to Team2
Updating Release     : x930-5.4.7-1.1.rel information on Team2
=====
Copying Release      : x930-5.4.7-1.1.rel to Team3
Updating Release     : x930-5.4.7-1.1.rel information on Team3
=====
New firmware will not take effect until nodes are rebooted.
=====

ATMF_NETWORK[3]#
```

Related commands [atmf working-set](#)

atmf domain vlan

Overview The AMF domain VLAN is created when the AMF network is first initiated and is assigned a default VID of 4091. This command enables you to change the VID from this default value on this device.

The AMF domain VLAN is one of AMF's internal VLANs (the management VLAN is the other internal VLAN). AMF uses these internal VLANs to communicate network status information between nodes. These VLANs must be reserved for AMF and not used for other purposes.

An important point conceptually is that although the domain VLAN exists globally across the AMF network, it is assigned separately to each domain. The AMF network therefore can be thought of as comprising a series of domain VLANs each having the same VID and each being applied to a horizontal slice (domain) of the AMF. It follows therefore that the domain VLANs are only applied to ports that form cross-links and not to ports that form uplinks/downlinks.

CAUTION: Every member of your AMF network must have the same domain VLAN, management VLAN, and management subnet.

CAUTION: If you change the domain VLAN, management VLAN, or management subnet of a node, that change takes effect immediately and the node will immediately leave the AMF network and try to rejoin it. The AMF network will not be complete until you have given all devices the same setting, so they can all rejoin the AMF network.

Use the **no** variant of this command to reset the VLAN ID to its default value of 4091.

Syntax `atmf domain vlan <2-4090>`
`no atmf domain vlan`

Parameter	Description
<code><2-4090></code>	The VLAN number in the range 2 to 4090.

Default VLAN 4091

Mode Global Configuration

Usage notes We recommend you only change the domain VLAN when first creating the AMF network, and only if VLAN 4091 is already being used in your network.

However, if you do need to change the VLAN on an existing AMF network, use the following steps:

- 1) Create a working set of the whole of your AMF network, using the commands:

```
master# atmf working-set group all
```

You must use **working-set group all** if changing the domain VLAN. If you use a different working-set, nodes that are not in that working-set will lose contact with the AMF network.

- 2) The prompt will display the number of nodes in the AMF network. Record this number. In this example, the network is named "test" and has 10 nodes:

```
test[10]#
```

- 3) Enter the new VLAN ID, using the commands:

```
test[10]# configure terminal
```

```
test(config)[10]# atmf domain vlan <2-4090>
```

The nodes will execute the command in parallel, leave the AMF network, and attempt to rejoin through the new VLAN.

- 4) Create the working set again, using the commands:

```
master(config)# exit
```

```
master# atmf working-set group all
```

- 5) Save the configuration, using the command:

```
test[10]# write
```

- 6) The prompt will display the number of nodes in the AMF network. Check that this is the same as the number in step 1. If it is not, you will need to change the VLAN on missing devices by logging into their consoles directly.

NOTE: The domain VLAN will automatically be assigned an IP subnet address based on the value configured by the command *atmf management subnet*.

The default VLAN ID lies outside the user-configurable range. If you need to reset the VLAN to the default VLAN ID, use the **no** variant of this command to do so.

Examples To change the AMF domain VLAN to 4090 in an existing AMF network, use the following commands:

```
master# atmf working-set group all
```

```
test[10]# configure terminal
```

```
test(config)[10]# atmf domain vlan 4090
```

```
master(config)# exit
```

```
master# atmf working-set group all
```

```
test[10]# write
```

To reset the AMF domain VLAN to its default of 4091 in an existing AMF network, use the following commands:

```
master# atmf working-set group all
test[10]# configure terminal
test(config)[10]# no atmf domain vlan
master(config)# exit
master# atmf working-set group all
test[10]# write
```

Related commands

- [atmf management subnet](#)
- [atmf management vlan](#)

atmf enable

Overview This command manually enables (turns on) the AMF feature for the device being configured.

Use the **no** variant of this command to disable (turn off) the AMF feature on the member node.

Syntax atmf enable
no atmf enable

Default Once AMF is configured, the AMF feature starts automatically when the device starts up.

Mode Global Configuration

Usage notes The device does not auto negotiate AMF domain specific settings such as the Network Name. You should therefore, configure your device with any domain specific (non default) settings before enabling AMF.

Examples To turn off AMF, use the command:

```
MyNode# config terminal
MyNode(config)# no atmf enable
```

To turn on AMF, use the command:

```
MyNode(config)# atmf enable
```

This command returns the following display:

```
% Warning: The ATMF network config has been set to enable
% Save the config and restart the system for this change to take
effect.
```

atmf group (membership)

Overview This command configures a device to be a member of one or more AMF groups. Groups exist in three forms: Implicit Groups, Automatic Groups, and User-defined Groups.

- Implicit Groups
 - all: All nodes in the AMF
 - current: The current working-set
 - local: The originating node.

Note that the Implicit Groups do not appear in show group output.

- Automatic Groups - These are defined by hardware architecture, e.g. x510, x230, x8100, AR3050S, AR4050S.
- User-defined Groups - These enable you to define arbitrary groups of AMF members based on your own criteria.

Each node in the AMF is automatically assigned membership to the implicit groups, and the automatic groups that are appropriate to its node type, e.g. x230, PoE. Similarly, nodes that are configured as masters are automatically assigned to the master group.

Use the **no** variant of this command to remove the membership.

Syntax `atmf group <group-list>`
`no atmf group <group-list>`

Parameter	Description
<code><group-list></code>	A list of group names. These should be entered as a comma delimited list without spaces. Names can contain alphanumeric characters, hyphens and underscores.

Mode Global Configuration

Usage notes You can use this command to define your own arbitrary groups of AMF members based on your own network's configuration requirements. Applying a node to a non existing group will result in the group automatically being created.

Note that the master nodes are automatically assigned to be members of the pre-existing master group.

The following example configures the device to be members of three groups; two are company departments, and one comprises all devices located in building_2. To avoid having to run this command separately on each device that is to be added to these groups, you can remotely assign all of these devices to a working-set, then use the capabilities of the working-set to apply the [atmf group \(membership\)](#) command to all members of the working set.

Example 1 To specify the device to become a member of AMF groups named *marketing*, *sales*, and *building_2*, use the following commands:

```
node-1# configure terminal
node-1(config)# atmf group marketing,sales,building_2
```

Example 2 To add the nodes *member_node_1* and *member_node_2* to groups *building1* and *sales*, first add the nodes to the working-set:

```
master_node# atmf working-set member_node_1,member_node_2
```

This command returns the following output confirming that the nodes *member_node_1* and *member_node_2* are now part of the working-set:

```
=====
member_node_1, member_node_2
=====

Working set join
```

Then add the members of the working set to the groups:

```
atmf-net[2]# configure terminal
atmf-net[2](config)# atmf group building1,sales
atmf-net[2](config)# exit
atmf-net[2]# show atmf group
```

This command returns the following output displaying the groups that are members of the working-set.

```
=====
member_node_1
=====

AMF group information

building1, sales
```

Related commands [show atmf group](#)
[show atmf group members](#)

atmf guest-class

Overview This modal command creates a guest-class. Guest-classes are modal templates that can be applied to selected guest types. Once you have created a guest-class, you can select it by entering its mode. From here, you can then configure a further set of operational settings specifically for the new guest-class.

These settings can then all be applied to a guest link by running the [switchport atmf-guestlink](#) command. The following settings can be configured from each guest class mode:

- discovery method
- model type
- http-enable setting
- guest port, user name, and password

The **no** variant of this command removes the guest-class. Note that you cannot remove a guest-class that is assigned to a port.

Syntax `atmf guest-class <guest-class-name>`
`no atmf guest-class <guest-class-name>`

Parameter	Description
<code><guest-class-name></code>	The name assigned to the guest-class type. This can be chosen from an arbitrary string of up to 15 characters.

Mode Global Configuration

Example To create a guest-class named 'camera' use the commands:

```
node1# configure terminal
node1(config)# atmf guest-class camera
node1(config-atmf-guest)#
```

To remove the guest-class named 'camera' use the commands:

```
node1# configure terminal
node1(config)# no atmf guest-class camera
```

Related commands [show atmf area guests](#)

[discovery](#)

[http-enable](#)

[username \(atmf-guest\)](#)

[modeltype](#)

[switchport atmf-guestlink](#)

show atmf links guest

show atmf guests

login-fallback enable

atmf log-verbose

Overview This command limits the number of log messages displayed on the console or permanently logged.

Use the **no** variant of this command to reset to the default.

Syntax atmf log-verbose <1-3>
no atmf log-verbose

Parameter	Description
<1-3>	The verbose limitation (3 = noisiest, 1 = quietest)

Default The default log display is 3.

Usage This command is intended for use in large networks where verbose output can make the console unusable for periods of time while nodes are joining and leaving.

Mode Global Configuration

Example To set the log-verbose to noise level 2, use the command:

```
node-1# configure terminal
node-1(config)# atmf log-verbose 2
```

Validation Command `show atmf`

atmf management subnet

Overview This command is used to assign a subnet that will be allocated to the AMF management and domain management VLANs. From the address space defined by this command, two subnets are created, a management subnet component and a domain component, as explained in the Usage section below.

AMF uses these internal IPv4 subnets to communicate network status information between nodes. These subnet addresses must be reserved for AMF and not used for other purposes.

CAUTION: Every member of your AMF network must have the same domain VLAN, management VLAN, and management subnet.

CAUTION: If you change the domain VLAN, management VLAN, or management subnet of a node, that change takes effect immediately and the node will immediately leave the AMF network and try to rejoin it. The AMF network will not be complete until you have given all devices the same setting, so they can all rejoin the AMF network.

Use the **no** variant of this command to remove the assigned subnet.

Syntax atmf management subnet <a.b.0.0>
no atmf management subnet

Parameter	Description
<a.b.0.0>	The IP address selected for the management subnet. Because a mask of 255.255.0.0 (i.e. /16) will be applied automatically, an IP address in the format a.b.0.0 must be selected. Usually this subnet address is selected from an appropriate range from within the private address space of 172.16.0.0 to 172.31.255.255, or 192.168.0.0, as defined in RFC1918.

Default 172.31.0.0. A subnet mask of 255.255.0.0 will automatically be applied.

Mode Global Configuration

Usage notes Running this command will result in the creation of a further two subnets (within the class B address space assigned) and the mask will extend from /16 to /17.

For example, if the management subnet is assigned the address 172.31.0.0/16, this will result in the automatic creation of the following two subnets:

- 172.31.0.0/17 assigned to the [atmf management vlan](#)
- 172.31.128.0/17 assigned to the [atmf domain vlan](#).

We recommend you only change the management subnet when first creating the AMF network, and only if 172.31.0.0 is already being used in your network.

However, if you do need to change the subnet on an existing AMF network, use the following steps:

- 1) Create a working set of the whole of your AMF network, using the commands:

```
master# atmf working-set group all
```

You must use **working-set group all** if changing the domain VLAN, management VLAN, or management subnet. If you use a different working-set, nodes that are not in that working-set will lose contact with the AMF network.

- 2) The prompt will display the number of nodes in the AMF network. Record this number. In this example, the network is named "test" and has 10 nodes:

```
test[10]#
```

- 3) Enter the new subnet address, using the commands:

```
test[10]# configure terminal
```

```
test(config)[10]# atmf management subnet <a.b.0.0>
```

The nodes will execute the command in parallel, leave the AMF network, and attempt to rejoin through the new subnet.

- 4) Create the working set again, using the commands:

```
master(config)# exit
```

```
master# atmf working-set group all
```

- 5) Save the configuration, using the command:

```
test[10]# write
```

- 6) The prompt will display the number of nodes in the AMF network. Check that this is the same as the number in step 1. If it is not, you will need to change the subnet on missing devices by logging into their consoles directly.

Examples To change the AMF management subnet address to 172.25.0.0 in an existing AMF network, use the following commands:

```
master# atmf working-set group all
```

```
test[10]# configure terminal
```

```
test(config)[10]# atmf management subnet 172.25.0.0
```

```
master(config)# exit
```

```
master# atmf working-set group all
```

```
test[10]# write
```

To reset the AMF management subnet address to its default of 172.31.0.0 in an existing AMF network, use the following commands:

```
master# atmf working-set group all
test[10]# configure terminal
test(config)[10]# no atmf management subnet
master(config)# exit
master# atmf working-set group all
test[10]# write
```

Related commands

- [atmf domain vlan](#)
- [atmf management vlan](#)

atmf management vlan

Overview The AMF management VLAN is created when the AMF network is first initiated and is assigned a default VID of 4092. This command enables you to change the VID from this default value on this device.

The AMF management VLAN is one of AMF's internal VLANs (the domain VLAN is the other internal VLAN). AMF uses these internal VLANs to communicate network status information between nodes. These VLANs must be reserved for AMF and not used for other purposes.

CAUTION: Every member of your AMF network must have the same domain VLAN, management VLAN, and management subnet.

CAUTION: If you change the domain VLAN, management VLAN, or management subnet of a node, that change takes effect immediately and the node will immediately leave the AMF network and try to rejoin it. The AMF network will not be complete until you have given all devices the same setting, so they can all rejoin the AMF network.

Use the **no** variant of this command to restore the VID to the default of 4092.

Syntax `atmf management vlan <2-4090>`
`no atmf management vlan`

Parameter	Description
<code><2-4090></code>	The VID assigned to the AMF management VLAN.

Default VLAN 4092

Mode Global Configuration

Usage notes We recommend you only change the management VLAN when first creating the AMF network, and only if VLAN 4092 is already being used in your network.

However, if you do need to change the VLAN on an existing AMF network, use the following steps to ensure you change it on all nodes simultaneously:

- 1) Create a working set of the whole of your AMF network, using the commands:

```
master# atmf working-set group all
```

You must use **working-set group all** if changing the management VLAN. If you use a different working-set, nodes that are not in that working-set will lose contact with the AMF network.

- 2) The prompt will display the number of nodes in the AMF network. Record this number. In this example, the network is named "test" and has 10 nodes:

```
test[10]#
```

- 3) Enter the new VLAN ID, using the commands:

```
test[10]# configure terminal
test(config)[10]# atmf management vlan <2-4090>
```

The nodes will execute the command in parallel, leave the AMF network, and attempt to rejoin through the new VLAN.

- 4) Create the working set again, using the commands:

```
master(config)# exit
master# atmf working-set group all
```

- 5) Save the configuration, using the command:

```
test[10]# write
```

- 6) The prompt will display the number of nodes in the AMF network. Check that this is the same as the number in step 1. If it is not, you will need to change the VLAN on missing devices by logging into their consoles directly.

NOTE: The management VLAN will automatically be assigned an IP subnet address based on the value configured by the command [atmf management subnet](#).

The default VLAN ID lies outside the user-configurable range. If you need to reset the VLAN to the default VLAN ID, use the **no** variant of this command to do so.

Examples To change the AMF management VLAN to 4090 in an existing AMF network, use the following commands:

```
master# atmf working-set group all
test[10]# configure terminal
test(config)[10]# atmf management vlan 4090
master(config)# exit
master# atmf working-set group all
test[10]# write
```

To reset the AMF management VLAN to its default of 4092 in an existing AMF network, use the following commands:

```
master# atmf working-set group all
test[10]# configure terminal
test(config)[10]# no atmf management vlan
master(config)# exit
master# atmf working-set group all
test[10]# write
```

Related commands [atmf domain vlan](#)
[atmf management subnet](#)

atmf master

Overview This command configures the device to be an AMF master node and automatically creates an AMF master group. The master node is considered to be the core of the AMF network, and must be present for the AMF to form. The AMF master has its node depth set to 0. Note that the node depth vertical distance is determined by the number of uplinks/downlinks that exist between the node and its master.

An AMF master node must be present for an AMF network to form. Up to two AMF master nodes may exist in a network, and they **must** be connected by an AMF crosslink.

NOTE: Master nodes are an essential component of an AMF network. In order to run AMF, an AMF License is required for each master node.

If the crosslink between two AMF masters fails, then one of the masters will become isolated from the rest of the AMF network.

Use the **no** variant of this command to remove the device as an AMF master node. The node will retain its node depth of 0 until the network is rebooted.

NOTE: Node depth is the vertical distance (or level) from the master node (whose depth value is 0).

Syntax atmf master
no atmf master

Default The device is not configured to be an AMF master node.

Mode Global Configuration

Example To specify that this node is an AMF master, use the following command:

```
node-1# configure terminal
node-1(config)# atmf master
```

Related commands [show atmf](#)
[show atmf group](#)

atmf mtu

Overview This command configures the AMF network Maximum Transmission Unit (MTU). The MTU value will be applied to the AMF Management VLAN, the AMF Domain VLAN and AMF Area links.

Use the **no** variant of this command to restore the default MTU.

Syntax `atmf mtu <1300-1442>`
`no atmf mtu`

Parameter	Description
<code><1300-1442></code>	The value of the maximum transmission unit for the AMF network, which sets the maximum size of all AMF packets generated from the device.

Default 1300

Mode Global Configuration

Usage notes The default value of 1300 will work for all AMF networks (including those that involve virtual links over IPsec tunnels). If there are virtual links over IPsec tunnels anywhere in the AMF network, we recommend not changing this default. If there are no virtual links over IPsec tunnels, then this AMF MTU value may be increased for network efficiency.

Example To change the ATMF network MTU to 1442, use the command:

```
awplus(config)# atmf mtu 1442
```

Related commands [show atmf detail](#)

atmf network-name

Overview This command applies an AMF network name to a (prospective) AMF node. In order for an AMF network to be valid, its network-name must be configured on at least two nodes, one of which must be configured as a master and have an AMF License applied. These nodes may be connected using either AMF downlinks or crosslinks.

For more information on configuring an AMF master node, see the command [atmf master](#).

Use the **no** variant of this command to remove the AMF network name.

Syntax `atmf network-name <name>`
`no atmf network-name`

Parameter	Description
<code><name></code>	The AMF network name. Up to 15 printable characters can be entered for the network-name.

Mode Global Configuration

Usage notes This is one of the essential commands when configuring AMF and must be entered on each node that is to be part of the AMF.

A switching node (master or member) may be a member of only one AMF network.

CAUTION: *Ensure that you enter the correct network name. Entering an incorrect name will cause the AMF network to fragment (at the next reboot).*

Example To set the AMF network name to `amf_net` use the command:

```
Node_1(config)# atmf network-name amf_net
```

atmf provision (interface)

Overview This command configures a specified port on an AMF node to accept a provisioned node, via an AMF link, some time in the future.

Use the **no** variant of this command to remove the provisioning on the node.

Syntax `atmf provision <nodename>`
`no atmf provision`

Parameter	Description
<code><nodename></code>	The name of the provisioned node that will appear on the AMF network in the future.

Mode Interface Configuration for a switchport, a static aggregator, dynamic channel group or an Eth port on an AR-Series device.

Usage notes The port should be configured as an AMF link or cross link and should be 'down' to add or remove a provisioned node.

Example To provision an AMF node named node1 for port1.0.1, use the commands:

```
host1(config)# interface port1.0.1
host1(config-if)# atmf provision node1
```

Related commands

- `atmf provision node`
- `clone (amf-provision)`
- `configure boot config (amf-provision)`
- `configure boot system (amf-provision)`
- `copy (amf-provision)`
- `create (amf-provision)`
- `delete (amf-provision)`
- `identity (amf-provision)`
- `license-cert (amf-provision)`
- `locate (amf-provision)`
- `show atmf provision nodes`
- `show atmf links`
- `switchport atmf-link`
- `switchport atmf-crosslink`

atmf provision node

Overview Use this command to provision a replacement node for a specified interface. Node provisioning is effectively the process of creating a backup file-set on a master node that can be loaded onto a provisioned node some time in the future. This file-set is created just as if the provisioned node really existed and was connected to the network. Typically these comprise configuration, operating system, and license files etc.

You can optionally provision a node with multiple device-type backups. When a device is then attached to the network, AMF uses its device-type to find the correct configuration to use. For example you can create an x510 and an x530 provisioning configuration for a node called 'node1' and if either an x510 or an x530 is attached to that node the appropriate configuration will be used.

Use the **no** variant of this command to remove a provisioned node.

Syntax `atmf provision node <nodename> [device <device-type>]`
`no atmf provision node <nodename> [device <device-type>]`

Parameter	Description
<nodename>	The name of the provisioned node that will appear on the AMF network.
device	Optionally specify a device type.
<device-type>	Any valid device type e.g. AR3050s, ie200, x950. For a full list of valid device types use the command atmf provision node <nodename> device ? .

Mode Privileged Exec

Usage notes This command creates the directory structure for the provisioned node's file-set. It also switches to the AMF provision node prompt so that the nodes backup file-set can be created or updated. This is typically done with the [create \(amf-provision\)](#) or [clone \(amf-provision\)](#) commands.

For more information on AMF provisioning, see the [AMF Feature Overview and Configuration Guide](#)..

Example To configure node named 'node1', use the command:

```
awplus# atmf provision node node1  
awplus(atmf-provision) #
```

To configure a node named 'node1' for device type 'x530', use the command:

```
awplus# atmf provision node node1 device x530  
awplus(atmf-provision) #
```

Related commands

- atmf provision (interface)
- clone (amf-provision)
- configure boot config (amf-provision)
- configure boot system (amf-provision)
- copy (amf-provision)
- create (amf-provision)
- delete (amf-provision)
- identity (amf-provision)
- license-cert (amf-provision)
- locate (amf-provision)
- show atmf provision nodes

Command changes Version 5.4.9-0.1: command added

atmf reboot-rolling

Overview This command enables you to reboot the nodes in an AMF working-set, one at a time, as a rolling sequence in order to minimize downtime. Once a rebooted node has finished running its configuration and its ports are up, it re-joins the AMF network and the next node is rebooted.

By adding the *url* parameter, you can also upgrade your devices' software one AMF node at a time.

The **force** parameter forces the rolling reboot to continue even if a previous node does not rejoin the AMF network. Without the **force** parameter, the unsuitable node will time-out and the rolling reboot process will stop. However, with the **force** parameter applied, the process will ignore the timeout and move on to reboot the next node in the sequence.

This command can take a significant amount of time to complete.

Syntax `atmf reboot-rolling [force] [<url>]`

Parameter	Description
<code>force</code>	Ignore a failed node and move on to the next node. Where a node fails to reboot a timeout is applied based on the time taken during the last reboot.
<code><url></code>	The path to the software upgrade file.

Mode Privileged Exec

Usage notes You can load the software from a variety of locations. The latest compatible release for a node will be selected from your selected location, based on the parameters and URL you have entered.

For example `card:/5.4.6/x*-5.4.6-*.rel` will select from the folder `card:/5.4.6` the latest file that matches the selection `x` (wildcard) `-5.4.6-` (wildcard).rel. Because `x*` is applied, each device type will be detected and its appropriate release file will be installed.

Other allowable entries are:

Entry	Used when loading software
<code>card:*.rel:</code>	from an SD card
<code>tftp:<ip-address>:</code>	from a TFTP server
<code>usb:</code>	from a USB flash drive
<code>flash:</code>	from flash memory, e.g. from one x930 switch to another
<code>scp:</code>	using secure copy
<code>http:</code>	from an HTTP file server

Several checks are performed to ensure the upgrade will succeed. These include checking the current node release boots from flash. If there is enough space on flash, the software release is copied to flash to a new location on each node as it is processed. The new release name will be updated using the **boot system**<release-name> command, and the old release will become the backup release file.

NOTE: If you are using TFTP or HTTP, for example, to access a file on a remote device then the URL should specify the exact release filename without using wild card characters.

On bootup the software release is verified. Should an upgrade fail, the upgrading unit will revert back to its previous software version. At the completion of this command, a report is run showing the release upgrade status of each node.

NOTE: Take care when removing external media or rebooting your devices. Removing an external media while files are being written entails a significant risk of causing a file corruption.

Example 1 To reboot all x510 nodes in an AMF network, use the following command:

```
Bld2_Floor_1# atmf working-set group x510
```

This command returns the following type of screen output:

```
=====
node1, node2, node3:
=====

Working set join

AMF_NETWORK[3]#
```

```
ATMF_NETWORK[3]# atmf reboot-rolling
```

When the reboot has completed, a number of status screens appear. The selection of these screens will depend on the parameters set.

```
Bld2_Floor_1#atmf working-set group x510

=====
SW_Team1, SW_Team2, SW_Team3:
=====

Working set join

ATMF_NETWORK[3]#atmf reboot-rolling
ATMF Rolling Reboot Nodes:

Node Name                Timeout
                        (Minutes)
-----
SW_Team1                  14
SW_Team2                   8
SW_Team3                   8
Continue the rolling reboot ? (y/n):y
=====
ATMF Rolling Reboot: Rebooting SW_Team1
=====

% SW_Team1 has left the working-set
Reboot of SW_Team1 has completed
=====
ATMF Rolling Reboot: Rebooting SW_Team2
=====

% SW_Team2 has left the working-set
Reboot of SW_Team2 has completed
=====
ATMF Rolling Reboot: Rebooting SW_Team3
=====

% SW_Team3 has left the working-set
Reboot of SW_Team3 has completed
=====
ATMF Rolling Reboot Complete
Node Name                Reboot Status
-----
SW_Team1                  Rebooted
SW_Team2                  Rebooted
SW_Team3                  Rebooted
=====
```

Example 2 To update firmware releases, use the following command:

```
Node_1# atmf working-set group all

ATMF_NETWORK[9]# atmf reboot-rolling
card:/5.4.6/x*-5.4.6-*.rel
```

```
ATMF Rolling Reboot Nodes:
```

Node Name	Timeout (Minutes)	New Release File	Status
SW_Team1	8	x510-5.4.6-0.1.rel	Release Ready
SW_Team2	10	x510-5.4.6-0.1.rel	Release Ready
SW_Team3	8	---	Not Supported
HW_Team1	6	---	Incompatible
Bld1_Floor_2	2	x930-5.4.6-0.1.rel	Release Ready
Bld1_Floor_1	4	---	Incompatible
Building_1	2	---	Incompatible
Building_2	2	x908-5.4.6-0.1.rel	Release Ready

Continue upgrading releases ? (y/n):

atmf recover

Overview This command is used to manually initiate the recovery (or replication) of an AMF node, usually when a node is being replaced.

Syntax `atmf recover [<node-name> master <node-name>]`
`atmf recover [<node-name> controller <node-name>]`

Parameter	Description
<i><node-name></i>	The name of the device whose configuration is to be recovered or replicated.
master <i><node-name></i>	The name of the master device that holds the required configuration information. Note that although you can omit both the node name and the master name; you cannot specify a master name unless you also specify the node name.
controller <i><node-name></i>	The name of the controller that holds the required configuration information. Note that although you can omit both the node name and the controller name; you cannot specify a controller name unless you also specify the node name.

Mode Privileged Exec

Usage notes The recovery/replication process involves loading the configuration file for a node that is either about to be replaced or has experienced some problem. You can specify the configuration file of the device being replaced by using the *<node-name>* parameter, and you can specify the name of the master node or controller holding the configuration file.

If the *<node-name>* parameter is not entered then the node will attempt to use one that has been previously configured. If the replacement node has no previous configuration (and has no previously used node-name), then the recovery will fail.

If the master or controller name is not specified then the device will poll all known AMF masters and controllers and execute an election process (based on the last successful backup and its timestamp) to determine which to use. If no valid backup master or controller is found, then this command will fail.

No error checking occurs when this command is run. Regardless of the last backup status, the recovering node will attempt to load its configuration from the specified master node or controller.

If the node has previously been configured, we recommend that you suspend any AMF backup before running this command. This is to prevent corruption of the backup files on the AMF master as it attempts to both backup and recover the node at the same time.

Example To recover the AMF node named Node_10 from the AMF master node named Master_2, use the following command:

```
Master_2# atmf recover Node_10 master Master_2
```

Related commands

- atmf backup stop
- show atmf backup
- show atmf

atmf recover guest

Overview Use this command to initiate a guest node recovery or replacement by reloading its backup file-set that is located within the AMF backup system. Note that this command must be run on the edge node device that connects to the guest node.

Syntax `atmf recover guest [<guest-port>]`

Parameter	Description
<code><guest-port></code>	The port number that connects to the guest node.

Mode User Exec/Privileged Exec

Example To recover a guest on node1 port1.0.1, use the following command

```
node1# atmf recover guest port1.0.1
```

Related commands [show atmf backup guest](#)

atmf recover led-off

Overview This command turns off the recovery failure flashing port LEDs. It reverts the LED's function to their normal operational mode, and in doing so assists with resolving the recovery problem. You can repeat this process until the recovery failure has been resolved. For more information, see the [AMF Feature Overview and Configuration Guide](#).

Syntax `atmf recover led-off`

Default Normal operational mode

Mode Privileged Exec

Example To revert the LEDs on Node1 from recovery mode display to their normal operational mode, use the command:

```
Node1# atmf recover led-off
```

Related commands [atmf recover](#)

atmf recover over-eth

Overview Use this command to enable AMF recovery over an AR-series device's Eth port. This setting persists even after restoring a device to a 'clean' state with the [erase factory-default](#) or [atmf cleanup](#) command.

Use the **no** variant of this command to disable AMF recover over an Eth port.

Syntax `atmf recover over-eth`
`no atmf recover over-eth`

Default Eth ports cannot be used for recovery.

Mode Privileged Exec

Usage notes AMF links over Eth ports are only available if your network is running in AMF secure mode (see [atmf secure-mode](#) for more information on AMF secure mode).

Example To enable AMF recovery over an Eth port, use the command:

```
awplus# atmf recover over-eth
```

To disable AMF recovery over an Eth port, use the commands:

```
awplus# no atmf recover over-eth
```

Related commands [atmf-link](#)
[atmf recover](#)
[atmf secure-mode](#)
[erase factory-default](#)
[show atmf detail](#)

Command changes Version 5.5.0-1.1: command added

atmf recovery-server

Overview Use this command on an AMF master to process recovery requests from isolated AMF nodes. An isolated node is an AMF member that is only connected to the rest of the AMF network via a virtual-link.

This option allows these nodes, which have no AMF neighbors, to be identified for recovery or provisioning purposes. They are identified using an identity token which is stored on the AMF master.

Use the **no** variant of this command to disable processing of recovery requests from isolated AMF nodes.

Syntax `atmf recovery-server`
`no atmf recovery-server`

Default Recovery-server is disabled by default.

Mode Global Configuration

Usage notes Once **recovery-server** is enabled on an AMF network, the next time an isolated node is backed up its identity token will be stored in the AMF master's database. Should the device fail it can then be replaced and auto-recovery will occur as long as:

- the AMF master is accessible to the isolated node, and
- either, a DHCP server is configured to send the Uniform Resource Identifier (URI) of the AMF master to the recovering node, or
- a DNS server is configured to resolve the default recovery URI (`https://amf recovery.alliedtelesis.com`) to the IP address of the AMF master.

Provisioning of isolated nodes is achieved by creating an identity token for the new node using the [identity \(amf-provision\)](#) command.

See the [AMF Feature Overview and Configuration Guide](#) for information on preparing your network for recovering or provisioning isolated nodes.

Example To enable recovery-server on an AMF master, use the commands:

```
awplus# configure terminal
awplus(config)# atmf recovery-server
```

To disable recovery-server on an AMF master, use the commands:

```
awplus# configure terminal
awplus(config)# no atmf recovery-server
```

Related commands

- [atmf backup](#)
- [atmf cleanup](#)
- [identity \(amf-provision\)](#)
- [atmf virtual-link](#)

Command changes Version 5.4.7-2.1: command added

atmf remote-login

Overview Use this command to remotely login to other AMF nodes in order to run commands as if you were a local user of that node.

Syntax `atmf remote-login [user <name>] <nodename>`

Parameter	Description
<name>	The name of a user on the remote node.
<nodename>	The name of the remote AMF node you are connecting to.

Mode Privileged Exec (This command will only run at privilege level 15)

Usage notes You do not need a valid login on the local device in order to run this command. The session will take you to the enable prompt on the new device. If the remote login session exits for any reason (e.g. device reboot) you will be returned to the originating node.

You can create additional user accounts on nodes. AMF's goal is to provide a uniform management plane across the whole network, so we recommend you use the same user accounts on all the nodes in the network.

In reality, though, it is not essential to have the same accounts on all the nodes. Users can remote login from one node to a second node even if they are logged into the first node with a user account that does not exist on the second node (provided that `atmf restricted-login` is disabled and the user account on the first node has privilege level 15).

Moreover, it is possible to use a RADIUS or TACACS+ server to manage user authentication, so users can log into AMF nodes using user accounts that are present on the RADIUS or TACACS+ server, and not present in the local user databases of the AMF nodes.

The software will not allow you to run multiple remote login sessions. You must exit an existing session before starting a new one.

If you disconnect from the VTY session without first exiting from the AMF remote session, the device will keep the AMF remote session open until the `exec-timeout` time expires (10 minutes by default). If the `exec-timeout` time is set to infinity (`exec-timeout 0 0`), then the device is unable to ever close the remote session. To avoid this, we recommend you use the `exit` command to close AMF remote sessions, instead of closing the associated VTY sessions. We also recommend you avoid setting the `exec-timeout` to infinity.

Example To remotely login from node Node10 to Node20, use the following command:

```
Node10# atmf remote-login node20
Node20>
```

To close the session on Node20 and return to Node10's command line, use the following command:

```
Node20# exit  
Node10#
```

In this example, user User1 is a valid user of node5. They can remotely login from node5 to node3 by using the following commands:

```
node5# atmf remote-login user User1 node3  
node3> enable
```

Related commands [atmf restricted-login](#)

Command changes Version 5.4.6-2.1: changes to AMF user account requirements

atmf restricted-login

Overview By default, users who are logged into any node on an AMF network are able to manage any other node by using either working-sets or an AMF remote login. If the access provided by this feature is too wide, or contravenes network security restrictions, it can be limited by running this command, which changes the access so that:

- users who are logged into non-master nodes cannot execute any commands that involve working-sets, and
- from non-master nodes, users can use remote-login, but only to login to a user account that is valid on the remote device (via a statically configured account or RADIUS/TACACS+). Users are also required to enter the password for that user account.

Once entered on any AMF master node, this command will propagate across the network.

Use the **no** variant of this command to disable restricted login on the AMF network. This allows access to the **atmf working-set** command from any node in the AMF network.

Syntax `atmf restricted-login`
`no atmf restricted-login`

Mode Privileged Exec

Default Master nodes operate with **atmf restricted-login** disabled.
Member nodes operate with **atmf restricted-login** enabled.

NOTE: *The default conditions of this command vary from those applied by its “no” variant. This is because the restricted-login action is only applied by **master** nodes, and in the absence of a master node, the default is to apply the restricted action to all **member** nodes with AMF configured.*

Usage notes In the presence of a **master** node, its default of **atmf restricted-login disabled** will propagate to all its member nodes. Similarly, any change in this command’s status that is made on a master node, will also propagate to all its member nodes

Note that once you have run this command, certain other commands that utilize the AMF working-set command, such as the **include**, **atmf reboot-rolling** and **show atmf group members** commands, will operate only on master nodes.

Restricted-login must be enabled on AMF areas with more than 120 nodes.

Example To enable restricted login, use the command

```
Node_20(config)# atmf restricted-login node20
```

Related commands [atmf remote-login](#)
[show atmf](#)

Command changes Version 5.4.6-2.1: changes to AMF user account requirements

atmf retry guest-link

Overview Use this command to retry an AMF guest-link by restarting AMF guest discovery on a port if it is currently in the failed state.

If no port is specified then all configured AMF guest-link ports that are in the failed state are retried.

If a port is specified then that port will only be retried if it is both:

- configured as an AMF guest-link, and
- it is currently in the failed state.

Syntax `atmf retry guest-link [<interface>]`

Parameter	Description
<code><interface></code>	Name of the interface the guest-link you want to retry is configured on.

Mode Privileged Exec

Example To retry all configured AMF guest-link currently in a failed state, use the command:

```
awplus# atmf retry guest-link
```

To retry an AMF guest-link configured on port1.0.2 currently in a failed state, use the command:

```
awplus# atmf retry guest-link port1.0.2
```

Related commands [show atmf links guest](#)
[switchport atmf-guestlink](#)

atmf secure-mode

Overview Use this command to enable AMF secure mode on an AMF node. AMF secure mode makes an AMF network more secure by:

- Adding an authorization mechanism before and AMF member is allowed to join an AMF network.
- The encryption of all AMF packets sent between AMF nodes.
- Adding support for user login authentication by RADIUS or TACACS+, and removing the requirement to have the same privileged user account in the local user database on all devices in the AMF network.
- Adding additional logging which enables network administrators to monitor attempts to gain unauthorized access to the AMF network.

Once the secure mode command is run on all nodes on an AMF network, the AMF masters and AMF controllers manage the addition of AMF nodes and AMF areas to the AMF network.

Use the **no** variant of this command to disable AMF secure mode on an AMF node.

Syntax `atmf secure-mode`
`no atmf secure-mode`

Default Secure mode is disabled by default.

Mode Global Configuration

Usage notes When an AMF network is running in AMF secure mode the [atmf restricted-login](#) feature is automatically enabled. This restricts the [atmf working-set](#) command to users that are logged on to an AMF master. This feature cannot be disabled independently of secure mode.

When AMF secure mode is enabled the AMF controllers and masters in the AMF network form a group of certificate authorities. A node may only join a secure AMF network once it has been authorized by a master or controller. When enabled, all devices in the AMF network must be running in secure mode. Unsecured devices will not be able to join a secure AMF network.

Example To enable AMF secure mode on an AMF node, use the commands:

```
awplus# configure terminal
awplus(config)# atmf secure-mode
```

To disable AMF secure mode on an AMF node, use the commands:

```
awplus# configure terminal
awplus(config)# no atmf secure-mode
```

Related commands [atmf authorize](#)
[atmf secure-mode certificate expiry](#)

clear atmf secure-mode certificates
clear atmf secure-mode statistics
show atmf
show atmf authorization
show atmf secure-mode
show atmf secure-mode certificates
show atmf secure-mode sa
show atmf secure-mode statistics

Command changes Version 5.4.7-0.3: command added

atmf secure-mode certificate expire

Overview Use this command on an AMF master to expire a secure mode certificate. Running this command will force the removal of the AMF node from the network.

Syntax `atmf secure-mode certificate expire <node-name> [area <area-name>]`

Parameter	Description
<code><node-name></code>	Name of the AMF node you want to expire the certificate for.
<code>area</code>	Specify an AMF area.
<code><area-name></code>	Name of the AMF area you want to expire the AMF nodes certificate for.

Mode Privileged Exec

Example To remove an AMF node named "node3" from an AMF network, use the following command on the AMF master:

```
awplus# atmf secure-mode certificate expire node3
```

To remove an AMF node named "node2" in an area named "area2", use the following command on the AMF master:

```
awplus# atmf secure-mode certificate expire node2 area area2
```

Related commands

- [atmf secure-mode](#)
- [show atmf secure-mode](#)
- [show atmf secure-mode certificates](#)

Command changes Version 5.4.7-0.3: command added

atmf secure-mode certificate expiry

Overview Use this command to set the expiry time of AMF secure mode certificates. Once an AMF node's certificate expires it must re-authorize and obtain a new certificate from the AMF master.

Use the **no** variant of this command to reset the expiry time to 180 days.

Syntax `atmf secure-mode certificate expiry {<days>|infinite}`
`no atmf secure-mode certificate expiry`

Parameter	Description
<code><days></code>	Length of time, in days, that an AMF secure mode certificate remains valid. A value between 1 and 365.
<code>infinite</code>	The authorization certificate does not expire, in other words AMF nodes stay authorized indefinitely.

Default The default expiry time is 180 days.

Mode Global Configuration

Example To set AMF secure mode certificate expiry to 7 days, use the commands:

```
awplus# configure terminal
awplus(config)# atmf secure-mode certificate expiry 7
```

To set AMF secure mode certificates to never expire, use the commands:

```
awplus# configure terminal
awplus(config)# atmf secure-mode certificate expiry infinite
```

To reset the certificate expiry to 180 days, use the commands:

```
awplus# configure terminal
awplus(config)# no atmf secure-mode certificate expiry
```

Related commands [atmf secure-mode](#)
[show atmf secure-mode](#)
[show atmf secure-mode certificates](#)

Command changes Version 5.4.7-0.3: command added

atmf secure-mode certificate renew

Overview Use this command to force all local certificates to expire and be renewed on an AMF secure mode network.

Secure mode certificates renew automatically but this command could be used to renew a certificate in a situation where the automatic renewal may happen while the device is not attached to the AMF network.

Syntax `atmf secure-mode certificate renew`

Mode Privileged Exec

Example To renew a local certificate on a AMF member or AMF master, use the command:

```
awplus# atmf secure-mode certificate renew
```

Related commands [show atmf secure-mode certificates](#)
[show atmf secure-mode statistics](#)

Command changes Version 5.4.7-0.3: command added

atmf secure-mode enable-all

Overview Use this command to enable AMF secure mode on an entire network. AMF secure mode makes an AMF network more secure by:

- Adding an authorization mechanism before an AMF member is allowed to join an AMF network.
- The encryption of all AMF packets sent between AMF nodes.
- Adding support for user login authentication by RADIUS or TACACS+, and removing the requirement to have the same privileged user account in the local user database on all devices in the AMF network.
- Adding additional logging which enables network administrators to monitor attempts to gain unauthorized access to the AMF network.

Once this command is run on an AMF network, the AMF masters and AMF controllers manage the addition of AMF nodes and AMF areas to the AMF network.

This command can only be run on an AMF master.

Use the **no** variant of this command to disable AMF secure mode on an entire network.

Syntax `atmf secure-mode enable-all`
`no atmf secure-mode enable-all`

Default Secure mode is disabled by default.

Mode Privileged Exec

Usage notes When an AMF network is running in AMF secure mode the [atmf restricted-login](#) feature is automatically enabled. This restricts the [atmf working-set](#) command to users that are logged on to an AMF master. This feature cannot be disabled independently of secure mode.

When AMF secure mode is enabled the AMF controllers and masters in the AMF network form a group of certificate authorities. A node may only join a secure AMF network once it has been authorized by a master or controller. When enabled, all devices in the AMF network must be running in secure mode. Unsecured devices will not be able to join a secure AMF network.

Running **atmf secure-mode enable-all**:

- Groups all AMF members in a working set.
- Executes [clear atmf secure-mode certificates](#) on the working set of members, which removes existing secure mode certificates from all the nodes.
- Groups all the AMF masters in a working set.
- Executes [atmf authorize provision all](#) on the working set of masters, so all masters provision all nodes.
- Groups all AMF nodes in a working set.

- Runs a script which executes `atmf secure-mode` and then writes the configuration file on each node.
- Starts a timer that ticks every 10 seconds, for a maximum of 10 times, and checks if all the secure mode capable nodes rejoin the AMF network.

Running **no atmf secure-mode enable-all**:

- Groups all AMF nodes in a working set.
- Runs a script which executes **no atmf secure-mode** and then writes the configuration file on each node.
- Starts a timer that ticks every 10 seconds, for a maximum of 10 times, and checks if all the secure mode capable nodes rejoin the AMF network.

NOTE: Enabling or disabling secure mode on the network saves the running-config on every device.

Example To enable AMF secure mode on the entire network, use the command:

```
awplus# atmf secure-mode enable-all
```

You will be prompted to confirm the action:

```
Total number of nodes 21
21 nodes support secure-mode

Enable secure-mode across the AMF network ? (y/n): y
```

To disable AMF secure mode on the entire network, use the command:

```
awplus# no atmf secure-mode enable-all
```

You will be prompted to confirm the action:

```
% Warning: All security certificates will be deleted.
Disable secure-mode across the AMF network ? (y/n): y
```

Related commands [aaa authentication auth-web](#)
[show atmf](#)

Command changes Version 5.4.7-0.3: command added

atmf select-area

Overview Use this command to access devices in an area outside the core area on the controller network. This command will connect you to the remote area-master of the specified area.

This command is only valid on AMF controllers.

The **no** variant of this command disconnects you from the remote area-master.

Syntax `atmf select-area {<area-name>|local}`
`no atmf select-area`

Parameter	Description
<code><area-name></code>	Connect to the remote area-master of the area with this name.
<code>local</code>	Return to managing the local controller area.

Mode Privileged Exec

Usage notes After running this command, use the [atmf working-set](#) command to select the set of nodes you want to access in the remote area.

Example To access nodes in the area Canterbury, use the command

```
controller-1# atmf select-area Canterbury
```

This displays the following output:

```
Test_network[3]#atmf select-area Canterbury
=====
Connected to area Canterbury via host Avensis:
=====
```

To return to the local area for controller-1, use the command

```
controller-1# atmf select-area local
```

Alternatively, to return to the local area for controller-1, use the command

```
controller-1# no atmf select-area
```

Related commands [atmf working-set](#)

atmf topology-gui enable

Overview Use this command to enable the operation of Vista Manager EX on the Master device.

Vista Manager EX delivers state-of-the-art monitoring and management for your Autonomous Management Framework™ (AMF) network, by automatically creating a complete topology map of switches, firewalls and wireless access points (APs). An expanded view includes third-party devices such as security cameras.

Use the **no** variant of this command to disable operation of Vista Manager EX.

Syntax atmf topology-gui enable
no atmf topology-gui enable

Default Disabled by default on AMF Master and member nodes. Enabled by default on Controllers.

Mode Global Configuration mode

Usage notes To use Vista Manager EX, you must also enable the HTTP service on all AMF nodes, including all AMF masters and controllers. The HTTP service is enabled by default on AlliedWare Plus switches and disabled by default on AR-Series firewalls. To enable it, use the commands:

```
Node1# configure terminal
Node1(config)# service http
```

On one master in each AMF area in your network, you also need to configure the master to send event notifications to Vista Manager EX. To do this, use the commands:

```
Node1# configure terminal
Node1(config)# log event-host <ip-address> atmf-topology-event
```

Examples To enable Vista Manager EX on Node1, use the commands:

```
Node1# configure terminal
Node1(config)# atmf topology-gui enable
```

To disable Vista Manager EX on Node1, use the commands:

```
Node1# configure terminal
Node1(config)# no atmf topology-gui enable
```

Related commands [atmf enable](#)
[log event-host](#)
[service http](#)

atmf trustpoint

Overview Use this command to set a PKI trustpoint for an AMF network. This command needs to be run on an AMF master or controller.

The self-signed certificate authority (CA) certificate is distributed to every node on the AMF network. It is used to verify client certificates signed by the trustpoint.

Use the **no** variant of this command to remove an AMF trustpoint.

Syntax `atmf trustpoint <trustpoint-name>`
`no atmf trustpoint <trustpoint-name>`

Parameter	Description
<code><trustpoint-name></code>	Name of the trustpoint.

Default No trustpoint is configured by default.

Mode Global Configuration

Usage notes Before using the **atmf trustpoint** command you will need to establish a trustpoint. For example, you can create a local self-signed trustpoint using the procedure outlined below.

Create a self-signed trustpoint called 'our_trustpoint' with keypair 'our_key':

```
awplus# configure terminal
awplus(config)# crypto pki trustpoint our_trustpoint
awplus(ca-trustpoint)# enrollment selfsigned
awplus(ca-trustpoint)# rsakeypair our_key
awplus(ca-trustpoint)# exit
awplus(config)# exit
```

Create the root and server certificates for this trustpoint:

```
awplus# crypto pki authenticate our_trustpoint
awplus# crypto pki enroll our_trustpoint
```

For more information about the AlliedWare Plus implementation of Public Key Infrastructure (PKI), see the [Public Key Infrastructure \(PKI\) Feature Overview and Configuration Guide](#)

Example To configure an AMF trustpoint for the trustpoint 'our_trustpoint', use the commands:

```
awplus# configure terminal
awplus(config)# atmf trustpoint our_trustpoint
```

To remove an AMF trustpoint for the trustpoint 'our_trustpoint', use the commands:

```
awplus# configure terminal  
awplus(config)# no atmf trustpoint our_trustpoint
```

Related commands [crypto pki trustpoint](#)
[show atmf](#)

Command changes Version 5.4.7-2.1: command added

atmf virtual-crosslink

Overview Use this command to create a virtual crosslink. A virtual crosslink connects an AMF master or controller on a physical device to a Virtual AMF Appliance (VAA) master or controller.

All AMF master nodes must reside in the same AMF domain and are required to be directly connected using AMF crosslinks. In order to be able to meet this requirement for AMF masters running on VAAs, a virtual crosslink connects the AMF master or controller on the physical device to the master or controller on the VAA.

Note that AlliedWare Plus CentreCOM Series switches are AMF Edge nodes and do not support virtual links or crosslinks. This is because each edge node can only have a single physical AMF link.

Use the **no** variant of this command to remove a virtual crosslink.

Syntax

```
atmf virtual-crosslink id <local-id> ip <local-ip> remote-id <remote-id> remote-ip <remote-ip>
```

```
atmf virtual-crosslink id <local-id> ip <local-ip> remote-id <remote-id> remote-host <domainname>
```

```
no atmf virtual-crosslink id <local-id>
```

Parameter	Description
id <local-id>	ID of the local tunnel port, a value between 1 and 4094.
ip <local-ip>	IPv4 address of the local tunnel port in a.b.c.d format.
remote-id <remote-id>	ID of the remote tunnel port, a value between 1 and 4094.
remote-ip <remote-ip>	IPv4 address of the remote tunnel port in a.b.c.d format.
remote-host <domainname>	The domain name of the remote node.

Default No AMF virtual crosslinks are created by default.

Mode Global Configuration

Usage notes This command allows a virtual tunnel to be created between two remote sites over a Layer 3 link. The tunnel encapsulates AMF packets and allows them to be sent transparently across a Wide Area Network (WAN) such as the Internet.

Configuration involves creating a local tunnel ID, a local IP address, a remote tunnel ID, and a remote IP address or domain name. Each side of the tunnel must be configured with the same, but mirrored parameters.

NOTE: *Virtual crosslinks are not supported on AMF container masters, therefore if multiple tenants on a single VAA host are configured for secure mode, only a single AMF master is supported per area.*

Example To setup a virtual link from a local site, 'siteA', to a remote site, 'siteB', (assuming there is already IP connectivity between the sites), run the following commands at the local site:

```
siteA# configure terminal
siteA(config)# atmf virtual-crosslink id 5 ip 192.168.100.1
remote-id 10 remote-ip 192.168.200.1
```

At the remote site, run the commands:

```
siteB# configure terminal
siteB(config)# atmf virtual-crosslink id 10 ip 192.168.200.1
remote-id 5 remote-ip 192.168.100.1
```

To remove this virtual crosslink, run the following commands on the local site:

```
siteA# configure terminal
siteA(config)# no atmf virtual-crosslink id 5
```

On the remote site, run the commands:

```
siteB# configure terminal
siteB(config)# no atmf virtual-crosslink id 10
```

Related commands

- [atmf virtual-crosslink](#)
- [show atmf links](#)
- [switchport atmf-crosslink](#)

Command changes

- Version 5.5.2-0.1: **remote-host** parameter added
- Version 5.4.7-0.3: command added

atmf virtual-link

Overview This command creates one or more Layer 2 tunnels that enable AMF nodes to transparently communicate across a wide area network using Layer 2 connectivity protocols.

Once connected through the tunnel, the remote member will have the same AMF capabilities as a directly connected AMF member.

Note that AlliedWare Plus CentreCOM Series switches are AMF Edge nodes and do not support virtual links or crosslinks. This is because each edge node can only have a single physical AMF link.

Use the **no** variant of this command to remove the specified virtual link.

Syntax

```
atmf virtual-link id <1-4094> ip <a.b.c.d> remote-id <1-4094>
remote-ip <a.b.c.d> [remote-area <area-name>]

atmf virtual-link id <1-4094> interface <interface-name>
remote-id <1-4094> remote-ip <a.b.c.d> [remote-area
<area-name>]

atmf virtual-link id <1-4094> ip <a.b.c.d> remote-id <1-4094>
remote-host <domainname> [remote-area <area-name>]

atmf virtual-link id <1-4094> interface <interface-name>
remote-id <1-4094> remote-host <domainname> [remote-area
<area-name>]

no atmf virtual-link id <1-4094>
```

Parameter	Description
id <1-4094>	ID of the local tunnel point, in the range 1 to 4094.
ip <a.b.c.d>	Specify the local IP address of the local interface for the virtual-link (alternatively you can specify the interface's name, see below).
interface <interface-name>	Specify the local interface name for the virtual-link. This allows you to use a dynamic, rather than a static, local IP address.
remote-id <1-4094>	The ID of the (same) tunnel that will be applied by the remote node. Note that this must match the local-id that is defined on the remote node. This means that (for the same tunnel) the local and remote tunnel IDs are reversed on the local and remote nodes.
remote-ip <a.b.c.d>	The IP address of the remote node.
remote-host <domainname>	The domain name of the remote node.
remote-area <area-name>	The name of the remote area connected to this virtual-link.

Mode Global Configuration

Usage notes The Layer 2 tunnel that this command creates enables a local AMF session to appear to pass transparently across a Wide Area Network (WAN) such as the Internet. The addresses configured as the local and remote tunnel IP addresses must have IP connectivity to each other. If the tunnel is configured to connect a head office and branch office over the Internet, typically this would involve using some type of managed WAN service such as a site-to-site VPN. Tunnels are only supported using IPv4.

Configuration involves creating a local tunnel ID, a local IP address, a remote tunnel ID and a remote IP address or domain name. A reciprocal configuration is also required on the corresponding remote device. The local tunnel ID must be unique to the device on which it is configured.

If an interface acquires its IP address dynamically then the local side of the tunnel can be specified by using the interface's name instead of using its IP address. When using a dynamic local address the remote address of the other side of the virtual-link must be configured with either:

- the IP address of the NAT device the dynamically configured interface is behind, or
- 0.0.0.0, if the virtual-link is configured as a secure virtual-link.

For instructions on how to configure dynamic IP addresses on virtual-links, see the [AMF Feature Overview and Configuration Guide](#).

The tunneled link may operate via external (non AlliedWare Plus) routers in order to provide wide area network connectivity. However in this configuration, the routers perform a conventional router to router connection. The protocol tunneling function is accomplished by the AMF nodes.

NOTE: *AMF cannot achieve zero touch replacement of the remote device that terminates the tunnel connection, because you must pre-configure the local IP address and tunnel ID on that remote device.*

Example 1 Use the following commands to create the tunnel shown in the figure below.

Figure 51-1: AMF virtual link example

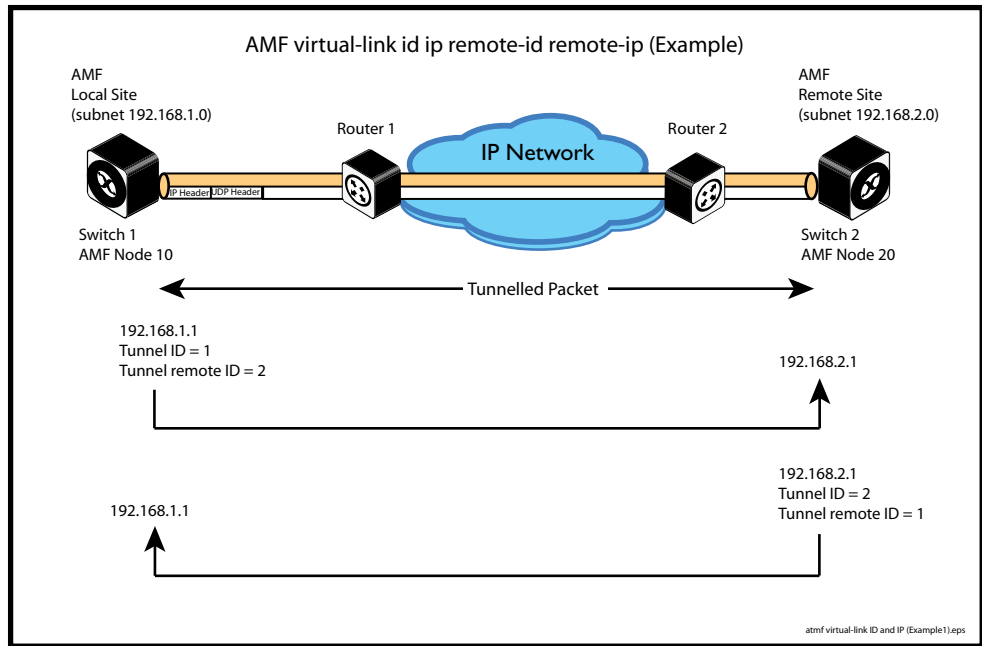

```
Node_10(config)# atmf virtual-link id 1 ip 192.168.1.1
remote-id 2 remote-ip 192.168.2.1

Node_20(config)# atmf virtual-link id 2 ip 192.168.2.1
remote-id 1 remote-ip 192.168.1.1
```

Example 2 To set up an area virtual link to a remote site (assuming IP connectivity between the sites already), one site must run the following commands:

```
SiteA# configure terminal

SiteA(config)# atmf virtual-link id 5 ip 192.168.100.1
remote-id 10 remote-ip 192.168.200.1 remote-area SiteB-AREA
```

The second site must run the following commands:

```
SiteB# configure terminal

SiteB(config)# atmf virtual-link id 10 ip 192.168.200.1
remote-id 5 remote-ip 192.168.100.1 remote-area SiteA-AREA
```

Before you can apply the above **atmf virtual-link** command, you must configure the area names *SiteB-AREA* and *SiteA-AREA*.

- Related commands**
- [atmf virtual-link description](#)
 - [atmf virtual-link protection](#)
 - [show atmf](#)
 - [show atmf links](#)
 - [show atmf virtual-links](#)

- Command changes**
- Version 5.5.2-0.1: **remote-host** parameter added
 - Version 5.4.9-0.1: **interface** parameter added

atmf virtual-link description

Overview Use this command to add a description to an existing AMF virtual-link.

Note that AlliedWare Plus CentreCOM Series switches are AMF Edge nodes and do not support virtual links or crosslinks. This is because each edge node can only have a single physical AMF link.

Use the **no** variant of this command to remove a description from an AMF virtual-link.

Syntax `atmf virtual-link id <1-4094> description <description>`
`no atmf virtual-link id <1-4094> description`

Parameter	Description
<code>id <1-4094></code>	ID of the local tunnel point.
<code><description></code>	A description for the virtual-link.

Default No description is set by default.

Mode Global Configuration

Example To add a description to the virtual-link with id '5', use the commands:

```
awplus# configure terminal
awplus(config)# atmf virtual-link id 5 description TO SITE B
```

To remove a description from the virtual-link with id '5', use the commands:

```
awplus# configure terminal
awplus(config)# no atmf virtual-link id 5
```

Related commands [atmf virtual-link](#)
[show atmf links](#)
[show atmf virtual-links](#)

atmf virtual-link protection

Overview Use this command to add protection to an existing AMF virtual-link. Secure AMF virtual-links encapsulate the L2TPv3 frames of the virtual-link with IPsec.

Note that AlliedWare Plus CentreCOM Series switches are AMF Edge nodes and do not support virtual links or crosslinks. This is because each edge node can only have a single physical AMF link.

Use the **no** variant of this command to remove protection from an AMF virtual-link.

Syntax

```
atmf virtual-link id <1-4094> protection ipsec key [8]
<key-string>

no atmf virtual-link id <1-4094> protection
```

Parameter	Description
id	Specify the link ID.
<1-4094>	Link ID in the range 1 to 4094,
protection	Protection is on for this link.
ipsec	Security provided using IPsec.
key	Set the shared key.
8	Specifies a string in an encrypted format instead of plain text. The running config will display the new password as an encrypted string even if password encryption is turned off.
<key-string>	Specify the shared key for the link.

Default Protection is off by default.

Mode Global Configuration

Usage notes The following limitations need to be considered when creating secure virtual-links.

- Switch devices support a maximum of 20 downstream AMF nodes when using a secure virtual-link as an uplink.
- When there are two or more AMF members behind a shared NAT device, only one of the members will be able to use secure virtual-links.
- An AMF Multi-tenant environment supports a maximum cumulative total of 1200 secure virtual-links across all AMF containers.

Secure virtual-links are only supported on the following device listed in the table below. There is also a limit to the number of links these devices support.

Device	Virtual-link Limit
AMF Cloud/ VAA	300
AR4050S AR3050S AR2050V AR2010V	60
x220 x230/x230L x310 x510/x510L IX5-28GPX	2

Example To create and configure a virtual link with protection first create the virtual-link:

```
Host-A# configure terminal
```

```
Host-A(config)# atmf virtual-link id 1 ip 192.168.1.1 remote-id  
2 remote-ip 192.168.2.1
```

Enable protection on the virtual link:

```
Host-A(config)# atmf virtual-link id 1 protection ipsec key  
securepassword
```

Repeat these steps on the other side of the link:

```
Host-B(config)# atmf virtual-link id 2 ip 192.168.2.1 remote-id  
1 remote-ip 192.168.1.1
```

```
Host-B(config)# atmf virtual-link id 2 protection ipsec key  
securepassword
```

**Related
commands** [atmf virtual-link](#)
[show atmf](#)

[show atmf links](#)

[show atmf virtual-links](#)

**Command
changes** Version 5.4.9-0.1: command added

atmf working-set

Overview Use this command to execute commands across an individually listed set of AMF nodes or across a named group of nodes.

Note that this command can only be run on a master node.

Use the **no** variant of this command to remove members or groups from the current working-set.

Syntax

```
atmf working-set {[<node-list>]| [group  
{<group-list>|all|local|current}]}
```

```
no atmf working-set {[<node-list>]| [group <group-list>]}
```

Parameter	Description
<code><node-list></code>	A comma delimited list (without spaces) of nodes to be included in the working-set.
<code>group</code>	The AMF group.
<code><group-list></code>	A comma delimited list (without spaces) of groups to be included in the working-set. Note that this can include either defined groups, or any of the Automatic, or Implicit Groups shown earlier in the bulleted list of groups.
<code>all</code>	All nodes in the AMF.
<code>local</code>	Local node Running this command with the parameters group local will return you to the local prompt and local node connectivity.
<code>current</code>	Nodes in current list.

Mode Privileged Exec

Usage notes You can put AMF nodes into groups by using the [atmf group \(membership\)](#) command.

This command opens a session on multiple network devices. When you change the working set to anything other than the local device, the prompt will change to the AMF network name, followed by the size of the working set, shown in square brackets. This command has to be run at privilege level 15.

In addition to the user defined groups, the following system assigned groups are automatically created:

- Implicit Groups
 - local: The originating node.
 - current: All nodes that comprise the current working-set.
 - all: All nodes in the AMF.

- Automatic Groups - These can be defined by hardware architecture, e.g. x510, x610, x8100, AR3050S or AR4050S, or by certain AMF nodal designations such as master.

Note that the Implicit Groups do not appear in `show atmf group` command output. If a node is an AMF master it will be automatically added to the master group.

Example 1 To add all nodes in the AMF to the working-set, use the command:

```
node1# atmf working-set group all
```

NOTE: This command adds the implicit group "all" to the working set, where "all" comprises all nodes in the AMF.

This command displays an output screen similar to the one shown below:

```
=====
node1, node2, node3, node4, node5, node6:
=====

Working set join

ATMF_NETWORK_Name[6]#
```

Example 2 To return to the local prompt, and connect to only the local node, use the command:

```
ATMF_Network_Name[6]# atmf working-set group local
node1#
```

The following table describes the meaning of the prompts in this example.

Parameter	Description
ATMF_Network_Name	The name of the AMF network, as set by the <code>atmf network-name</code> command.
[6]	The number of nodes in the working-set.
node1	The name of the local node, as set by the <code>hostname</code> command.

bridge-group (amf-container)

Overview Use this command to connect an AMF container to a bridge created on a Virtual AMF Appliance (VAA) virtual machine for AMF Cloud. This allows the AMF container to connect to a physical network.

Note that this command is only available on AMF Cloud, not on AlliedWare Plus switches.

An AMF container is an isolated instance of AlliedWare Plus with its own network interfaces, configuration, and file system. The features available inside an AMF container are a sub-set of the features available on the host VAA. These features enable the AMF container to function as a uniquely identifiable AMF master and allows for multiple tenants (up to 60) to run on a single VAA host. See the [AMF Feature Overview and Configuration Guide](#) for more information on running multiple tenants on a single VAA host.

Use the **no** variant of this command to remove a bridge-group from an AMF container.

Syntax `bridge-group <bridge-id>`
`no bridge-group`

Parameter	Description
<code><bridge-id></code>	The ID of the bridge group to join, a number between 1 and 64.

Mode AMF Container Configuration

Usage notes Each container has two virtual interfaces:

- 1) Interface eth0, used to connect to the AMF controller on the VAA host via an AMF area-link, and configured using this [area-link](#) command.
- 2) Interface eth1, used to connect to the outside world using a bridged L2 network link, and configured using the **bridge-group** command.

Before using this command, a bridge must be created with the same bridge-id on the VAA host using the **bridge <bridge-id>** command.

See the [AMF Feature Overview and Configuration Guide](#) for more information on configuring the bridge.

Example To assign a bridge group to AMF container 'vac-wlg-1', use the commands:

```
awplus# configure terminal
awplus(config)# atmf container vac-wlg-1
awplus(config-atmf-container)# bridge-group 1
```

Related commands [atmf container](#)
[show atmf container](#)

Command changes Version 5.4.7-0.1: command added

clear application-proxy threat-protection

Overview Use this command to clear the threat protection for a specified address.

Syntax `clear application-proxy threat-protection {<ip-address>|<mac-address>|all}`

Parameter	Description
<code><ip-address></code>	The IPv4 address you wish to clear the threat for, in A.B.C.D format.
<code><mac-address></code>	The MAC address you wish to clear the threat for, in HHHH.HHHH.HHHH format.
<code>all</code>	Clear the threat for all IPv4 and MAC addresses.

Mode Privileged Exec

Example To clear the threat for 10.34.199.117, use the command:

```
awplus# clear application-proxy threat-protection 10.34.199.117
```

Related commands

- [application-proxy quarantine-vlan](#)
- [application-proxy threat-protection](#)
- [application-proxy threat-protection send-summary](#)
- [service atmf-application-proxy](#)
- [show application-proxy threat-protection](#)

Command changes Version 5.4.7-2.2: command added

clear atmf links

Overview Use this command with no parameters to manually reset all the AMF links on a device. You can optionally specify an interface or range of interfaces to reset the links on.

Certain events or topology changes can cause AMF links to be incorrect or outdated. Clearing the links forces AMF to relearn the information from neighboring nodes and create a fresh, correct, view of the network.

Syntax `clear atmf links [<interface-list>]`

Parameter	Description
<code><interface-list></code>	<p>The interfaces or ports to perform the reset on. An interface-list can be:</p> <ul style="list-style-type: none">• a switchport (e.g. port1.0.1)• a static channel group (e.g. sa2)• a dynamic (LACP) channel group (e.g. po2)• a local port (e.g. of0)• You can specify a continuous range of interfaces separated by a hyphen, or a comma-separated list (e.g. port1.0.1, port1.0.4-port1.0.18). <p>The specified interfaces must exist. If this parameter is left out then all links of the specified type will be reset on the device.</p>

Mode Privileged Exec

Example To clear all AMF links on a device, use the following command:

```
awplus# clear atmf links
```

To clear all AMF links on port1.0.1 to port1.0.4 and static aggregator sa1, use the following command:

```
awplus# clear atmf links port1.0.1-port1.0.4,sa1
```

Related commands [clear atmf links virtual](#)
[show atmf links](#)

Command changes Version 5.4.8-2.1: command added

clear atmf links virtual

Overview Use this command with no parameters to manually reset all the AMF virtual links on a device. You can, optionally, specify a comma separated list of virtual links to reset.

Certain events or topology changes can cause AMF links to be incorrect or outdated. Clearing the links forces AMF to relearn the information from neighboring nodes and create a fresh, correct view of the network.

Syntax `clear atmf links virtual [<virtuallink-list>]`

Parameter	Description
<code><virtuallink-list></code>	A single, or list, of AMF virtual link identifiers to reset. This must be a comma separated list of links e.g. <code>vlink1, vlink2, vlink3</code> . Specifying a link range e.g. <code>vlink1-vlink3</code> is not supported.

Mode Privileged Exec

Example To clear all AMF virtual links on a device, use the following command:

```
awplus# clear atmf links virtual
```

To clear AMF virtual links `vlink11` and `vlink21`, use the following command:

```
awplus# clear atmf links virtual vlink11,vlink22
```

Related commands [clear atmf links](#)
[show atmf links](#)

Command changes Version 5.4.8-2.1: command added

clear atmf links statistics

Overview This command resets the values of all AMF link, port, and global statistics to zero.

Syntax `clear atmf links statistics`

Mode Privilege Exec

Example To reset the AMF link statistics values, use the command:

```
node_1# clear atmf links statistics
```

Related commands [show atmf links statistics](#)

clear atmf recovery-file

Overview Use this command to delete all of a node's recovery files. It deletes the recovery files stored on:

- the local node,
- neighbor nodes, and
- external media (USB or SD card).

Syntax `clear atmf recovery-file`

Mode Privileged Exec

Usage notes AMF recovery files are created for nodes with special links. Special links include:

- virtual links,
- area links terminating on an AMF master, and
- area virtual links terminating on an AMF master.

An AMF node with one of these special links pushes its startup configuration to its neighbors and to any attached external media. It then fetches and applies this configuration at recovery time. This configuration enables it to contact the AMF master and initiate a recovery.

Recovery files can become out of date if:

- a node's neighbor is off line when changes are made to its configuration, or
- when a node no longer contains a special link.

Example To clear a node's recovery files, use the command:

```
node1# clear atmf recovery-file
```

Output Figure 51-2: If AlliedWare Plus detects that a node contains a special link then the following message is displayed

```
node1#clear atmf recovery-file
% Warning: ATMF recovery files have been removed.
ATMF recovery may fail. Please save running-configuration.
```

Related commands [show atmf recovery-file](#)

Command changes Version 5.4.8-0.2: command added

clear atmf secure-mode certificates

Overview Use this command to remove all certificates from an AMF member or master. AMF nodes will need to be re-authorized once this command has been run.

Syntax `clear atmf secure-mode certificates`

Mode Privileged Exec

Example To clear all certificates from an AMF node, use the command:

```
awplus# clear atmf secure-mode certificates
```

If this is the only master on the network you will see the following warning:

```
% Warning: This node is the only master in the network!  
All the nodes will become isolated and refuse to join any ATMF  
network. The certificates on all the isolated nodes must be  
cleared before rejoining an ATMF network will be possible.  
  
To clear certificates a reboot of the device is required.  
Clear certificates and Reboot ? (y/n):
```

On an AMF member you will see the following message:

```
To clear certificates a reboot of the device is required.  
Clear certificates and Reboot ? (y/n):
```

Related commands

- [atmf authorize](#)
- [atmf secure-mode](#)
- [show atmf authorization](#)
- [show atmf secure-mode certificates](#)

Command changes Version 5.4.7-0.3: command added

clear atmf secure-mode statistics

Overview Use this command to reset all secure mode statistics to 0.

Syntax `clear atmf secure-mode statistics`

Mode Privileged Exec

Example To reset the AMF secure mode statistics information, use the command:

```
awplus# clear atmf secure-mode statistic
```

Related commands [show atmf secure-mode](#)
[show atmf secure-mode statistics](#)

Command changes Version 5.4.7-0.3: command added

clone (amf-provision)

Overview This command sets up a space on the backup media for use with a provisioned node and copies into it almost all files and directories from a chosen backup or provisioned node.

Alternatively, you can set up a new, unique provisioned node by using the command [create \(amf-provision\)](#).

Syntax `clone <source-nodename>`

Parameter	Description
<code><source-nodename></code>	The name of the node whose configuration is to be copied for loading to the clone.

Mode AMF Provisioning

Usage notes This command is only available on master nodes in the AMF network.

When using this command it is important to be aware of the following:

- A copy of `<media>:atmf/<atmf_name>/nodes/<source_node>/flash` will be made for the provisioned node and stored in the backup media.
- The directory `<node_backup_dir>/flash/.config/ssh` is excluded from the copy.
- All contents of `<root_backup_dir>/nodes/<nodename>` will be deleted or overwritten.
- Settings for the expected location of other provisioned nodes are excluded from the copy.

The active and backup configuration files are automatically modified in the following ways:

- The **hostname** command is modified to match the name of the provisioned node.
- The **stack virtual-chassis-id** command is removed, if present.

Example To copy from the backup of 'device2' to create backup files for the new provisioned node 'device3' use the following command:

```
device1# atmf provision node device3  
device1(atmf-provision)# clone device2
```

Figure 51-3: Sample output from the **clone** command

```
device1# atmf provision node device3  
device1(atmf-provision)#clone device2  
Copying...  
Successful operation
```

To confirm that a new provisioned node has been cloned, use the command:

```
device1# show atmf backup
```

The output from this command is shown in the following figure, and shows the details of the new provisioned node 'device3'.

Figure 51-4: Sample output from the **show atmf backup** command

```
device1#show atmf backup

Scheduled Backup ..... Enabled
  Schedule ..... 1 per day starting at 03:00
  Next Backup Time ... 01 Oct 2018 03:00
Backup Bandwidth ..... Unlimited
Backup Media ..... USB (Total 7446.0MB, Free 7297.0MB)
Server Config .....
  Synchronization .... Unsynchronized
  Last Run ..... -
  1 ..... Unconfigured
  2 ..... Unconfigured
Current Action ..... Idle
  Started ..... -
  Current Node ..... -

-----
Node Name      Date           Time           In ATMF  On Media  Status
-----
device3        -              -              No       Yes       Prov
device1        30 Sep 2018   00:05:49      No       Yes       Good
device2        30 Sep 2018   00:05:44      Yes      Yes       Good
```

Related commands

- atmf provision (interface)
- atmf provision node
- configure boot config (amf-provision)
- configure boot system (amf-provision)
- copy (amf-provision)
- create (amf-provision)
- delete (amf-provision)
- identity (amf-provision)
- license-cert (amf-provision)
- locate (amf-provision)
- show atmf provision nodes

Command changes

Version 5.4.9-0.1: syntax change due to new AMF provisioning mode

configure boot config (amf-provision)

Overview This command sets the configuration file to use during the next boot cycle. This command can also set a backup configuration file to use if the main configuration file cannot be accessed for an AMF provisioned node. To unset the boot configuration or the backup boot configuration use the **no boot** command.

Syntax `configure boot config [backup] <file-path|URL>`
`configure no boot config [backup]`

Parameter	Description
backup	Specify that this is the backup configuration file.
<file-path URL>	The path or URL and name of the configuration file.

Default No boot configuration files or backup configuration files are specified for the provisioned node.

Mode AMF Provisioning

Usage notes When using this command to set a backup configuration file, the specified AMF provisioned node must exist. The specified file must exist in the flash directory created for the provisioned node in the AMF remote backup media.

Examples To set the configuration file 'branch.cfg' on the AMF provisioned node 'node1', use the command:

```
MasterNodeName# atmf provision node node1
MasterNodeName(atmf-provision)# configure boot config
branch.cfg
```

To set the configuration file 'backup.cfg' as the backup to the main configuration file on the AMF provisioned node 'node1', use the command:

```
MasterNodeName(atmf-provision)# configure boot config backup
usb:/atmf/amf_net/nodes/node1/config/backup.cfg
```

To unset the boot configuration, use the command:

```
MasterNodeName(atmf-provision)# configure no boot config
```

To unset the backup boot configuration, use the command:

```
MasterNodeName(atmf-provision)# configure no boot config backup
```

Related commands

- [atmf provision \(interface\)](#)
- [atmf provision node](#)
- [clone \(amf-provision\)](#)
- [configure boot system \(amf-provision\)](#)
- [create \(amf-provision\)](#)

delete (amf-provision)
identity (amf-provision)
license-cert (amf-provision)
locate (amf-provision)
show atmf provision nodes

**Command
changes**

Version 5.4.9-0.1: syntax change due to new AMF provisioning mode

configure boot system (amf-provision)

Overview This command sets the release file that will load onto a specified provisioned node during the next boot cycle. This command can also set the backup release file to be loaded for an AMF provisioned node. To unset the boot system release file or the backup boot release file use the **no boot** command.

Use the **no** variant of this command to return to the default.

This command can only be run on AMF master nodes.

Syntax `configure boot system [backup] <file-path|URL>`
`configure no boot system [backup]`

Parameter	Description
<file-path URL>	The path or URL and name of the release file.

Default No boot release file or backup release files are specified for the provisioned node.

Mode AMF Provisioning

Usage notes When using this command to set a backup release file, the specified AMF provisioned node must exist. The specified file must exist in the flash directory created for the provisioned node in the AMF remote backup media.

Examples To set the release file x930-5.4.9-0.1.rel on the AMF provisioned node 'node1', use the command:

```
MasterNodeName# atmf provision node node1
MasterNodeName(atmf-provision)# configure boot system
x930-5.4.9-0.1.rel
```

To set the backup release file x930-5.4.8-2.5.rel as the backup to the main release file on the AMF provisioned node 'node1', use the command:

```
MasterNodeName# atmf provision node node1
MasterNodeName(atmf-provision)# configure boot system backup
card:/atmf/amf_net/nodes/node1/flash/x930-5.4.8-2.5.rel
```

To unset the boot release, use the command:

```
MasterNodeName# atmf provision node node1
MasterNodeName(atmf-provision)# configure no boot system
```

To unset the backup boot release, use the command:

```
MasterNodeName# atmf provision node node1
MasterNodeName(atmf-provision)# configure no boot system backup
```

Related commands [atmf provision \(interface\)](#)

atmf provision node
clone (amf-provision)
configure boot config (amf-provision)
create (amf-provision)
delete (amf-provision)
identity (amf-provision)
license-cert (amf-provision)
locate (amf-provision)
show atmf provision nodes

Command changes Version 5.4.9-0.1: syntax change due to new AMF provisioning mode

copy (amf-provision)

Overview Use this command to copy configuration and release files for the node you are provisioning.

For more information about using the copy command see [copy \(filename\)](#) in the File and Configuration Management chapter.

Syntax `copy [force] <source-name> <destination-name>`

Parameter	Description
<code>force</code>	This parameter forces the copy command to overwrite the destination file, if it already exists, without prompting the user for confirmation.
<code><source-name></code>	The filename and path of the source file. See the Introduction of the File and Configuration Management chapter for valid syntax.
<code><destination-name></code>	The filename and path for the destination file. See Introduction of the File and Configuration Management chapter for valid syntax.

Mode AMF Provisioning

Example To copy a configuration file named `current.cfg` from Node_4's Flash into the `future_node` directory, and set that configuration file to load onto `future_node`, use the following commands:

```
node_4# atmf provision node future_node
node_4(atmf-provision)# create
node_4(atmf-provision)# locate
node_4(atmf-provision)# copy flash:current.cfg
./future_node.cfg
node_4(atmf-provision)# configure boot config future_node.cfg
```

Related commands

- [atmf provision \(interface\)](#)
- [atmf provision node](#)
- [clone \(amf-provision\)](#)
- [create \(amf-provision\)](#)
- [delete \(amf-provision\)](#)
- [locate \(amf-provision\)](#)
- [show atmf provision nodes](#)

Command changes Version 5.4.9-2.1: command added

create (amf-provision)

Overview This command sets up an empty directory on the backup media for use with a provisioned node. This directory can have configuration and release files copied to it from existing devices. Alternatively, the configuration files can be created by the user.

An alternative way to create a new provisioned node is with the command [clone \(amf-provision\)](#).

This command can only run on AMF master nodes.

Syntax create

Mode AMF Provisioning

Usage notes This command is only available on master nodes in the AMF network.

A date and time is assigned to the new provisioning directory reflecting when this command was executed. If there is a backup or provisioned node with the same name on another AMF master then the most recent one will be used.

Example To create a new provisioned node named "device2" use the command:

```
device1# atmf provision node device2  
device1(atmf-provision)# create
```

Running this command will create the following directories:

- `<media>:atmf/<atmf_name>/nodes/<node>`
- `<media>:atmf/<atmf_name>/nodes/<node>/flash`

To confirm the new node's settings, use the command:

```
device1# show atmf backup
```

The output for the **show atmf backup** command is shown in the following figure, and shows details for the new provisioned node 'device2'.

Figure 51-5: Sample output from the **show atmf backup** command

```
device1#show atmf backup

Scheduled Backup ..... Enabled
  Schedule ..... 1 per day starting at 03:00
  Next Backup Time .... 01 Oct 2018 03:00
Backup Bandwidth ..... Unlimited
Backup Media ..... USB (Total 7446.0MB, Free 7315.2MB)
Server Config .....
  Synchronization .... Unsynchronized
  Last Run ..... -
  1 ..... Unconfigured
  2 ..... Unconfigured
Current Action ..... Idle
  Started ..... -
  Current Node ..... -

-----
Node Name      Date          Time          In ATMF  On Media  Status
-----
device2        -             -             No       Yes       Prov
device1        30 Sep 2018  00:05:49     No       Yes       Good
```

For instructions on how to configure on a provisioned node, see the [AMF Feature Overview and Configuration Guide](#).

Related commands

- [atmf provision \(interface\)](#)
- [atmf provision node](#)
- [clone \(amf-provision\)](#)
- [copy \(amf-provision\)](#)
- [configure boot config \(amf-provision\)](#)
- [configure boot system \(amf-provision\)](#)
- [delete \(amf-provision\)](#)
- [identity \(amf-provision\)](#)
- [license-cert \(amf-provision\)](#)
- [locate \(amf-provision\)](#)
- [show atmf provision nodes](#)

Command changes

Version 5.4.9-0.1: syntax change due to new AMF provisioning mode

debug atmf

Overview This command enables the AMF debugging facilities, and displays information that is relevant (only) to the current node. The detail of the debugging displayed depends on the parameters specified.

If no additional parameters are specified, then the command output will display all AMF debugging information, including link events, topology discovery messages and all notable AMF events.

The **no** variant of this command disables either all AMF debugging information, or only the particular information as selected by the command's parameters.

Syntax

```
debug atmf  
[link|crosslink|arealink|database|neighbor|error|all]  
  
no debug atmf  
[link|crosslink|arealink|database|neighbor|error|all]
```

Parameter	Description
link	Output displays debugging information relating to uplink or downlink information.
crosslink	Output displays all crosslink events.
arealink	Output displays all arealink events.
database	Output displays only notable database events.
neighbor	Output displays only notable AMF neighbor events.
error	Output displays AMF error events.
all	Output displays all AMF events.

Default All debugging facilities are disabled.

Mode User Exec and Global Configuration

Usage notes If no additional parameters are specified, then the command output will display all AMF debugging information, including link events, topology discovery messages and all notable AMF events.

NOTE: An alias to the **no** variant of this command is [undebbug atmf](#) on page 2757.

Examples To enable all AMF debugging, use the command:

```
node_1# debug atmf
```

To enable AMF uplink and downlink debugging, use the command:

```
node_1# debug atmf link
```

To enable AMF error debugging, use the command:

```
node_1# debug atmf error
```

Related commands [no debug all](#)

debug atmf packet

Overview This command configures AMF Packet debugging parameters. The debug only displays information relevant to the current node. The command has following parameters:

Syntax debug atmf packet [direction {rx|tx|both}] [level {1|2|3}]
[timeout <seconds>] [num-pkts <quantity>]
[filter {node <name>|interface <ifname>}]
[pkt-type [1][2][3][4][5][6][7][8][9][10][11][12][13]]

Simplified Syntax

debug atmf packet	[direction {rx tx both}]
	[level {[1][2 3]}]
	[timeout <seconds>]
	[num-pkts <quantity>]
debug atmf packet filter	[node <name>]
	[interface <ifname>]
	[pkt-type [1][2][3][4][5][6][7][8][9][10][11][12][13]]

NOTE: You can combine the syntax components shown, but when doing so, you must retain their original order.

Default Level 1, both Tx and Rx, a timeout of 60 seconds with no filters applied.

NOTE: An alias to the **no** variant of this command - *undebug atmf* - can be found elsewhere in this chapter.

Mode User Exec and Global Configuration

Usage notes If no additional parameters are specified, then the command output will apply a default selection of parameters shown below:

Parameter	Description
direction	Sets debug to packet received, transmitted, or both
rx	packets received by this node
tx	Packets sent from this node
1	AMF Packet Control header Information, Packet Sequence Number. Enter 1 to select this level.
2	AMF Detailed Packet Information. Enter 2 to select this level.
3	AMF Packet HEX dump. Enter 3 to select this level.
timeout	Sets the execution timeout for packet logging

Parameter	Description
<seconds>	Seconds
num-pkts	Sets the number of packets to be dumped
<quantity>	The actual number of packets
filter	Sets debug to filter packets
node	Sets the filter on packets for a particular Node
<name>	The name of the remote node
interface	Sets the filter to dump packets from an interface (portx.x.x) on the local node
<ifname>	Interface port or virtual-link
pkt-type	Sets the filter on packets with a particular AMF packet type
1	Crosslink Hello BPDU packet with crosslink links information. Enter 1 to select this packet type.
2	Crosslink Hello BPDU packet with downlink domain information. Enter 2 to select this packet type.
3	Crosslink Hello BPDU packet with uplink information. Enter 3 to select this packet type.
4	Downlink and uplink hello BPDU packets. Enter 4 to select this packet type.
5	Non broadcast hello unicast packets. Enter 5 to select this packet type.
6	Stack hello unicast packets. Enter 6 to select this packet type.
7	Database description. Enter 7 to select this packet type.
8	DBE request. Enter 8 to select this packet type.
9	DBE update. Enter 9 to select this packet type.
10	DBE bitmap update. Enter 10 to select this packet type.
11	DBE acknowledgment. Enter 11 to select this packet type.
12	Area Hello Packets. Enter 12 to select this packet type.
13	Gateway Hello Packets. Enter 13 to select this packet type.

Examples To set a packet debug on node 1 with level 1 and no timeout, use the command:

```
node_1# debug atmf packet direction tx timeout 0
```

To set a packet debug with level 3 and filter packets received from AMF node 1:

```
node_1# debug atmf packet direction tx level 3 filter node_1
```

To enable send and receive 500 packets only on vlink1 for packet types 1, 7, and 11, use the command:

```
node_1# debug atmf packet num-pkts 500 filter interface vlink1  
pkt-type 1 7 11
```

This example applies the **debug atmf packet** command and combines many of its options:

```
node_1# debug atmf packet direction rx level 1 num-pkts 60  
filter node x930 interface port1.0.1 pkt-type 4 7 10
```

delete (amf-provision)

Overview This command deletes files that have been created for loading onto a provisioned node. It can only be run on master nodes.

Syntax delete

Mode AMF Provisioning

Usage notes This command is only available on master nodes in the AMF network. The command will only work if the provisioned node specified in the command has already been set up (although the device itself is still yet to be installed). Otherwise, an error message is shown when the command is run.

You may want to use the **delete** command to delete a provisioned node that was created in error or that is no longer needed.

This command cannot be used to delete backups created by the AMF backup procedure. In this case, use the command [atmf backup delete](#) to delete the files.

NOTE: *This command allows provisioned entries to be deleted even if they have been referenced by the [atmf provision \(interface\)](#) command, so take care to only delete unwanted entries.*

Example To delete backup files for a provisioned node named device3 use the command:

```
device1# atmf provision node device3  
device1(atmf-provision)# delete
```

To confirm that the backup files for provisioned node device3 have been deleted use the command:

```
device1# show atmf backup
```

The output should show that the provisioned node device3 no longer exists in the backup file, as shown in the figure below:

Figure 51-6: Sample output showing the **show atmf backup** command

```
device1#show atmf backup

Scheduled Backup ..... Enabled
  Schedule ..... 1 per day starting at 03:00
  Next Backup Time .... 01 Oct 2016 03:00
Backup Bandwidth ..... Unlimited
Backup Media ..... USB (Total 7446.0MB, Free 7297.0MB)
Server Config .....
  Synchronization ..... Unsynchronized
  Last Run ..... -
  1 ..... Unconfigured
  2 ..... Unconfigured
Current Action ..... Idle
  Started ..... -
  Current Node ..... -

-----
Node Name      Date           Time           In ATMF  On Media  Status
-----
device1        30 Sep 2016   00:05:49      No       Yes       Good
device2        30 Sep 2016   00:05:44      Yes      Yes       Good
```

Related commands

- atmf provision (interface)
- atmf provision node
- clone (amf-provision)
- configure boot config (amf-provision)
- configure boot system (amf-provision)
- create (amf-provision)
- identity (amf-provision)
- license-cert (amf-provision)
- locate (amf-provision)
- show atmf provision nodes

Command changes

Version 5.4.9-0.1: syntax change due to new AMF provisioning mode

discovery

Overview Use this command to specify how AMF learns about guest nodes.

AMF nodes gather information about guest nodes by using one of two internally defined discovery methods: static or dynamic.

With dynamic learning (the default method), AMF learns IP address and MAC addresses of guest nodes from LLDP or DHCP snooping. Dynamic learning is only supported when using IPv4. For IPv6, use static learning.

With static learning, you use the `switchport atmf-guestlink` command to specify the guest class name and IP address of the guest node attached to each individual switch port. AMF then learns the MAC addresses of each of the guests of that class from ARP or Neighbor discovery tables.

If you are using the static method, ensure that you have configured the appropriate class type for each of your statically discovered guest nodes.

The **no** variant of this command returns the discovery method to **dynamic**.

Syntax `discovery [static|dynamic]`
`no discovery`

Parameter	Description
<code>static</code>	Statically assigned.
<code>dynamic</code>	Learned from DCHCP Snooping or LLDP.

Default Dynamic

Mode AMF Guest Configuration

Usage notes This command is one of several modal commands that are configured and applied for a specific guest-class (mode). Its settings are automatically applied to a guest-node link by the `switchport atmf-guestlink` command.

NOTE: AMF guest nodes are not supported on ports using the OpenFlow protocol.

Example 1 To configure the discovery of the guest-class camera to operate statically, use the following commands:

```
Node1# configure terminal
Node1(config)# atmf guest-class camera
Node1(config-atmf-guest)# discovery static
```

Example 2 To return the discovery method for the guest class TQ4600-1 to its default of **dynamic**, use the following commands:

```
Node1# configure terminal
Node1(config)# atmf guest-class TQ4600-1
Node1(config-atmf-guest)# no discovery
```

Related commands

- atmf guest-class
- switchport atmf-guestlink
- show atmf links guest
- show atmf nodes

description (amf-container)

Overview Use this command to set the description on an AMF container on a Virtual AMF Appliance (VAA).

An AMF container is an isolated instance of AlliedWare Plus with its own network interfaces, configuration, and file system. The features available inside an AMF container are a sub-set of the features available on the host VAA. These features enable the AMF container to function as a uniquely identifiable AMF master and allows for multiple tenants (up to 60) to run on a single VAA host. See the [AMF Feature Overview and Configuration Guide](#) for more information on running multiple tenants on a single VAA host.

Use the **no** variant of this command to remove the description from an AMF container.

Syntax `description <description>`
`no description`

Parameter	Description
<code><description></code>	Enter up to 128 characters of text describing the AMF container.

Mode AMF Container Configuration

Example To set the description for AMF container “vac-wlg-1” to “Wellington area”, use the commands:

```
awplus# configure terminal
awplus(config)# atmf container vac-wlg-1
awplus(config-atmf-container)# description Wellington area
```

To remove the description for AMF container “vac-wlg-1”, use the commands:

```
awplus# configure terminal
awplus(config)# atmf container vac-wlg-1
awplus(config-atmf-container)# no description
```

Related commands [atmf container](#)
[show atmf container](#)

Command changes Version 5.4.7-0.1: command added

erase factory-default

Overview This command erases all data from NVS and all data from flash **except** the following:

- the boot release file (a .rel file) and its release setting file
- all license files
- the latest GUI release file

The device is then rebooted and returned to its factory default condition. The device can then be used for AMF automatic node recovery.

Syntax `erase factory-default`

Mode Privileged Exec

Usage notes This command is an alias to the [atmf cleanup](#) command.

Example To erase data, use the command:

```
Node_1# erase factory-default
```

```
This command will erase all NVS, all flash contents except for  
the boot release, a GUI resource file, and any license files,  
and then reboot the switch. Continue? (y/n):y
```

Related commands [atmf cleanup](#)

http-enable

Overview This command is used to enable GUI access to a guest node. When **http-enable** is configured, the port number is set to its default of 80. If the guest node is using a different port for HTTP, you can configure this using the **port** parameter.

This command is used to inform the GUI that this device has an HTTP interface at the specified port number so that a suitable URL can be provided to the user.

Use the **no** variant of this command to disable HTTP.

Syntax `http-enable [port <port-number>]`
`no http-enable`

Parameter	Description
port	TCP port number.
<port-number>	The port number to be configured.

Default Not set

Mode AMF Guest Configuration

Usage notes If **http-enable** is selected without a **port** parameter the port number will default to 80.

Example To enable HTTP access to a guest node on port 80 (the default), use the following commands:

```
node1# configure terminal
node1(config)# atmf guest-class Camera
node1(config-atmf-guest)# http-enable
```

To enable HTTP access to a guest node on port 400, use the following commands:

```
node1# configure terminal
node1(config)# atmf guest-class Camera
node1(config-atmf-guest)# http-enable port 400
```

To disable HTTP access to a guest node, use the following commands:

```
node1# configure terminal
node1(config)# atmf guest-class Camera
node1(config-atmf-guest)# no http-enable
```

Related commands [atmf guest-class](#)
[switchport atmf-guestlink](#)
[show atmf links guest](#)

`show atmf nodes`

identity (amf-provision)

Overview Use this command to create an identity token for provisioning an isolated AMF node. An isolated node is an AMF member that is only connected to the rest of the AMF network via a virtual-link.

This command allows these nodes, which have no AMF neighbors, to be identified for provisioning purposes. They are identified using an identity token which is based on either the next-hop MAC address of the provisioned node, or the serial number of the device being provisioned. This identity token is stored on the AMF master.

Use the **no** variant of this command to remove the identity token for a node.

Syntax

```
identity mac-address <mac-address> prefix  
<ip-address/prefix-length>  
  
identity serial-number <serial-number> prefix  
<ip-address/prefix-length>  
  
no identity
```

Parameter	Description
mac-address	Specify the next-hop MAC address of the device being provisioned.
<mac-address>	MAC address of the port the provisioned node is connected to, in the format xxxx.xxxx.xxxx.
serial-number	Specify the serial number of the device to be provisioned.
<serial-number>	Serial number of the device that is being provisioned.
prefix	IPv4 address, and prefix length, of the virtual-link interface on the isolated node
<ip-address/ prefix-length>	IPv4 address, and prefix length, in A.B.C.D/M format.

Mode AMF Provisioning

Usage notes To provision an isolated node, first create a configuration for the node using the [create \(amf-provision\)](#) and/or the [clone \(amf-provision\)](#) commands.

Then create an identity token for the provisioned node by either specifying its next-hop MAC address or by specifying the serial number of the replacement device. The advantage of using the next-hop MAC address is that any device, regardless of its serial number, can be added to the network but using the serial number maybe preferred in situations where the next-hop MAC address is not easy to obtain.

The [atmf recovery-server](#) option must be enabled on the AMF master before attempting to provision the device. This option allows the AMF master to process recovery requests from isolated AMF nodes.

See the [AMF Feature Overview and Configuration Guide](#) for information on preparing your network for recovering or provisioning isolated nodes.

Example To create a identity token on your AMF master for a device named “my-x930” with serial number “A10064A172100008”, use the command:

```
awplus# atmf provision node my-x930
awplus(atmf-provision)# identity serial-number
A10064A172100008 prefix 192.168.2.25/24
```

To create a identity token on your AMF master for a device named “my-x930” with next-hop MAC address “0000.cd28.0880”, use the command:

```
awplus# atmf provision node my-x930
awplus(atmf-provision)# identity mac-address 0000.cd28.0880
prefix 192.168.2.25/24
```

To delete the identity token from your AMF master for a device named “my-x930”, use the command:

```
awplus# atmf provision node my-x930
awplus(atmf-provision)# no identity
```

Related commands

- [atmf cleanup](#)
- [atmf provision \(interface\)](#)
- [atmf provision node](#)
- [atmf recovery-server](#)
- [atmf virtual-link](#)
- [clone \(amf-provision\)](#)
- [configure boot config \(amf-provision\)](#)
- [configure boot system \(amf-provision\)](#)
- [create \(amf-provision\)](#)
- [delete \(amf-provision\)](#)
- [license-cert \(amf-provision\)](#)
- [locate \(amf-provision\)](#)
- [show atmf provision nodes](#)

Command changes

Version 5.4.9-0.1: syntax change due to new AMF provisioning mode
Version 5.4.7-2.1: command added

license-cert (amf-provision)

Overview This command is used to set up the license certificate for a provisioned node.

The certificate file usually has all the license details for the network, and can be stored anywhere in the network. This command makes a hidden copy of the certificate file and stores it in the space set up for the provisioned node on AMF backup media.

For node provisioning, the new device has not yet been part of the AMF network, so the user is unlikely to know its product ID or its MAC address. When such a device joins the network, assuming that this command has been applied successfully, the copy of the certificate file will be applied automatically to the provisioned node.

Once the new device has been resurrected on the network and the certificate file has been downloaded to the provisioned node, the hidden copy of the certificate file is deleted from AMF backup media.

Use the **no** variant of this command to set it back to the default.

This command can only be run on AMF master nodes.

Syntax `license-cert <file-path|URL>`
`no license-cert`

Parameter	Description
<code><file-path URL></code>	The name of the certificate file. This can include the file-path of the file.

Default No license certificate file is specified for the provisioned node.

Mode AMF Provisioning

Usage notes This command is only available on master nodes in the AMF network. It will only operate if the provisioned node specified in the command has already been set up, and if the license certification is present in the backup file. Otherwise, an error message is shown when the command is run.

Example 1 To apply the license certificate 'cert1.txt' stored on a TFTP server for AMF provisioned node "device2", use the command:

```
device1# atmf provision node device2
device1(atmf-provision)# license-cert
tftp://192.168.1.1/cert1.txt
```

Example 2 To apply the license certificate 'cert2.txt' stored in the AMF master's flash directory for AMF provisioned node 'host2', use the command:

```
device1# atmf provision node host2
device1(atmf-provision)# license-cert /cert2.txt
```

To confirm that the license certificate has been applied to the provisioned node, use the command `show atmf provision nodes`. The output from this command is shown below, and displays license certification details in the last line.

Figure 51-7: Sample output from the `show atmf provision nodes` command

```
device1#show atmf provision nodes

ATMF Provisioned Node Information:

Backup Media .....: SD (Total 3827.0MB, Free 3481.1MB)

Node Name           : device2
Date & Time         : 06-Oct-2016 & 23:25:44
Provision Path      : card:/atmf/nodes

Boot configuration :
Current boot image  : x510-5.4.6-1.4.rel (file exists)
Backup boot image   : x510-5.4.6-1.3.rel (file exists)
Default boot config : flash:/default.cfg (file exists)
Current boot config : flash:/abc.cfg (file exists)
Backup boot config  : flash:/xyz.cfg (file exists)

Software Licenses :
Repository file     : ../configs/.sw_v2.lic
                   : ../configs/.swfeature.lic
Certificate file    : card:/atmf/lok/nodes/awplus1/flash/.atmf-lic-cert
```

- Related commands**
- [atmf provision \(interface\)](#)
 - [atmf provision node](#)
 - [clone \(amf-provision\)](#)
 - [configure boot config \(amf-provision\)](#)
 - [configure boot system \(amf-provision\)](#)
 - [create \(amf-provision\)](#)
 - [delete \(amf-provision\)](#)
 - [identity \(amf-provision\)](#)
 - [locate \(amf-provision\)](#)
 - [show atmf provision nodes](#)

Command changes Version 5.4.9-0.1: syntax change due to new AMF provisioning mode

locate (amf-provision)

Overview This command changes the present working directory to the directory of a provisioned node. This makes it easier to edit files and create a unique provisioned node in the backup.

This command can only be run on AMF master nodes.

NOTE: We advise that after running this command, you return to a known working directory, typically *flash*.

Syntax locate

Mode AMF Provisioning

Example To change the working directory that happens to be on device1 to the directory of provisioned node device2, use the following command:

```
device1# atmf provision node device2
device1[atmf-provision]# locate
```

The directory of the node device2 should now be the working directory. You can use the command `pwd` to check this, as shown in the following figure.

Figure 51-8: Sample output from the `pwd` command

```
device2#pwd
card:/atmf/building_2/nodes/device2/flash
```

The output above shows that the working directory is now the flash of device2.

Related commands

- [atmf provision \(interface\)](#)
- [atmf provision node](#)
- [clone \(amf-provision\)](#)
- [configure boot config \(amf-provision\)](#)
- [configure boot system \(amf-provision\)](#)
- [copy \(amf-provision\)](#)
- [create \(amf-provision\)](#)
- [delete \(amf-provision\)](#)
- [identity \(amf-provision\)](#)
- [license-cert \(amf-provision\)](#)
- [locate \(amf-provision\)](#)
- [pwd](#)
- [show atmf provision nodes](#)

Command changes Version 5.4.9-0.1: syntax change due to new AMF provisioning mode

log event-host

Overview Use this command to set up an external host to log AMF topology events through Vista Manager. This command is run on the Master device.

Use the **no** variant of this command to disable log events through Vista Manager.

Syntax `log event-host [<ipv4-addr>|<ipv6-addr>] atmf-topology-event`
`no log event-host [<ipv4-addr>|<ipv6-addr>] atmf-topology-event`

Parameter	Description
<code><ipv4-addr></code>	ipv4 address of the event host
<code><ipv6-addr></code>	ipv6 address of the event host

Default Log events are disabled by default.

Mode Global Configuration

Usage notes Event hosts are set so syslog sends the messages out as they come.

Note that there is a difference between log event and log host messages:

- Log event messages are sent out as they come by syslog
- Log host messages are set to wait for a number of messages (20) to send them out together for traffic optimization.

Example To enable Node 1 to log event messages from host IP address 192.0.2.31, use the following commands:

```
Node1# configure terminal
```

```
Node1(config)# log event-host 192.0.2.31 atmf-topology-event
```

To disable Node 1 to log event messages from host IP address 192.0.2.31, use the following commands:

```
Node1# configure terminal
```

```
Node1(config)# no log event-host 192.0.2.31 atmf-topology-event
```

Related commands [atmf topology-gui enable](#)

login-fallback enable

Overview Use this command to enable login fallback on TQ model AMF guest nodes. This allows AMF to try the factory default username and password if the guest node's saved username and password fail.

Use the **no** variant of this command to disable login fallback.

Syntax login-fallback enable
no login-fallback enable

Default Disabled

Mode AMF Guest Configuration

Usage notes This feature is only supported on TQ model guest nodes.

Login fallback means: if a guest node's saved username and password fail, AMF will try to connect to the node using the factory default username and password (manager/friend). When a new TQ replaces an existing TQ, this allows the new TQ to be discovered and managed as an AMF guest node. AMF can then start the AMF guest node recovery procedure.

Example To use the login fallback feature, first create an AMF guest class for TQ model APs. Then enable the login fall back feature.

For example, to enable login fallback on the guest-class AT-TQ5k, use the commands:

```
node1#configuration terminal
node1(config)#atmf guest-class AT-TQ5k
node1(config-atmf-guest)#login-fallback enable
node1(config-atmf-guest)#end
node1#
```

Related commands [atmf guest-class](#)
[modeltype](#)
[switchport atmf-guestlink](#)
[show atmf links guest](#)

Command changes Version 5.5.0-1.1: command added

modeltype

Overview This command sets the expected model type of the guest node. The model type will default to **other** if nothing is set.

Use the **no** variant of this command to reset the model type to **other**.

Syntax `modeltype {alliedware|aw+|onvif|tq|other}`
`no modeltype`

Parameter	Description
alliedware	A legacy Allied Telesis operating system.
aw+	The Allied Telesis AlliedWare Plus operating system.
onvif	ONVIF (Open Network Video Interface Forum) Profile Q devices
tq	An Allied Telesis TQ Series wireless access point.
other	Used where the model type is outside the above definitions.

Default Default to **other**

Mode AMF Guest Configuration

Examples To assign the model type **tq** to the guest-class called 'tq_device', use the commands:

```
node1# configure terminal
node1(config)# atmf guest-class tq_device
node1(config-atmf-guest)# modeltype tq
```

To remove the model type **tq** from the guest-class called 'tq_device', and reset it to the default of **other**, use the commands:

```
node1# configure terminal
node1(config)# atmf guest-class tq_device
node1(config-atmf-guest)# no modeltype
```

Related commands [atmf guest-class](#)
[switchport atmf-guestlink](#)
[show atmf links guest](#)

Command changes Version 5.4.9-2.1: **onvif** parameter added

service atmf-application-proxy

Overview Use this command to enable the AMF Application Proxy service. This service distributes messages across all AMF nodes.

Currently this is used for threat protection. When an AMF Security (AMF-Sec) Controller detects a threat, it issues a request to block the address the threat originated from. The AMF Application Proxy service distributes this message to all AMF nodes. An AMF master accepts this block request and instructs the subordinate AMF node to block the relevant device.

Use the **no** variant of this command to disable the AMF Application Proxy service.

Syntax `service atmf-application-proxy`
`no service atmf-application-proxy`

Default The AMF Application Proxy service is disabled by default.

Mode Global Configuration

Usage notes The AMF master maintains a list of all threats and will send this list to any AMF node, or VCS member, when it boots and joins the AMF network.

In order for this to work the follow must be configured:

- the AMF Application Proxy service on all AMF nodes that need to receive the messages.
- the Hypertext Transfer Protocol (HTTP) service on all nodes that are running the AMF Application Proxy service (see [service http](#)).

Example To enable the AMF Application Proxy service, use the commands

```
awplus# configure terminal
awplus(config)# service atmf-application-proxy
```

To disable the AMF Application Proxy service, use the commands

```
awplus# configure terminal
awplus(config)# no service atmf-application-proxy
```

Related commands [application-proxy threat-protection](#)
[application-proxy whitelist server](#)
[clear application-proxy threat-protection](#)
[show application-proxy threat-protection](#)

Command changes Version 5.4.7-2.2: command added

show application-proxy threat-protection

Overview Use this command to list all the IP addresses blocked by the AMF Application Proxy service. It also shows the global threat-detection configuration.

Syntax `show application-proxy threat-protection [all]`

Parameter	Description
all	Include information for non-local blocks.

Mode Privileged Exec

Example To list the addresses blocked by the AMF Application Proxy service, use the command:

```
awplus# show application-proxy threat-protection
```

Output Figure 51-9: Example output from **show application-proxy threat-protection**

```
awplus#show application-proxy threat-protection
Quarantine Vlan      : vlan200
Global IP-Filter     : Enabled
IP-Filter Limit Exceeded : 0
Redirect-URL        : http://my.dom/help.html

Client IP           Interface      MAC Address    VLAN    Action
-----
10.34.199.110      -             -             -       link-down
10.34.199.116      port1.0.3     001a.eb93.ec5d 1       drop
10.1.179.1         *             *             *       ip-filter
...
```

Table 51-1: Parameters in the output from **show application-proxy threat-protection**

Parameter	Description
Quarantine Vlan	The name of the quarantine VLAN.
Global IP-Filter	The status of global IP filtering.
IP-Filter Limit Exceeded	The number of times an ACL failed to be installed due to insufficient space.
Redirect-URL	The URL a blocked user is redirected to.

Related commands [application-proxy quarantine-vlan](#)
[application-proxy threat-protection](#)

clear application-proxy threat-protection
service atmf-application-proxy

Command changes Version 5.4.7-2.2: command added

show application-proxy whitelist advertised-address

Overview Use this command to show the Layer 3 interface and its IPv4 address that is advertised as the application-proxy whitelist address.

Syntax `show application-proxy whitelist advertised-address`

Mode Privileged Exec

Example To display the interface and IPv4 address advertised as the application-proxy whitelist address, use the command:

```
awplus# show application-proxy whitelist advertised-address
```

Output Figure 51-10: Example output from **show application-proxy whitelist advertised-address**

```
awplus#show application-proxy whitelist advertised-address
ATMF Application Proxy Whitelist advertised-address:
  Interface   : vlan1001
  IP address  : 10.34.16.5
```

Related commands [application-proxy whitelist advertised-address](#)
[application-proxy whitelist server](#)

Command changes Version 5.4.9-1.1: command added

show application-proxy whitelist interface

Overview Use this command to display the status of port authentication on the specified interface.

Syntax `show application-proxy whitelist interface [<interface-list>]`

Parameter	Description
<code><interface-list></code>	<p>The interfaces or ports to display information about. An interface-list can be:</p> <ul style="list-style-type: none">• a switchport (e.g. port1.0.4)• a static channel group (e.g. sa2)• a dynamic (LACP) channel group (e.g. po2)• a continuous range of ports separated by a hyphen (e.g. port1.0.1-1.0.4)• a comma-separated list (e.g. port1.0.1,port1.0.3-1.0.4). Do not mix port types in the same list. <p>The specified interface must exist.</p>

Mode Privileged Exec

Example To display the port authentication information for all interfaces, use the command:

```
awplus# show application-proxy whitelist interface
```

To display the port authentication information for port1.0.4, use the command

```
awplus# show application-proxy whitelist interface port1.0.4
```

Output Figure 51-11: Example output from **show application-proxy whitelist interface**

```
awplus#sh application-proxy whitelist interface
Authentication Info for interface port1.0.1
  portEnabled: false - portControl: Auto
  portStatus: Unknown
  reAuthenticate: disabled
  reAuthPeriod: 3600
  PAE: quietPeriod: 60 - maxReauthReq: 2 - txPeriod: 30
  PAE: connectTimeout: 30
  BE: suppTimeout: 30 - serverTimeout: 30
  CD: adminControlledDirections: in
  KT: keyTxEnabled: false
  critical: disabled
  guestVlan: disabled
  guestVlanForwarding:
    none
  authFailVlan: disabled
  dynamicVlanCreation: disabled
  multiVlanSession: disabled
  hostMode: single-host
  dot1x: disabled
  authMac: enabled
    method: PAP
    scheme: mac
    reauthRelearning: disabled
  authWeb: disabled
  twoStepAuthentication:
    configured: disabled
    actual: disabled
  supplicantMac: none
  supplicantIpv4: none
Authentication Info for interface port1.0.2
...
```

Related commands

- [application-proxy whitelist enable](#)
- [application-proxy whitelist server](#)
- [show application-proxy whitelist server](#)
- [show application-proxy whitelist supplicant](#)

Command changes Version 5.4.9-0.1: command added

show application-proxy whitelist server

Overview Use this command to display the external RADIUS server details for the application-proxy whitelist feature.

Syntax `show application-proxy whitelist server`

Mode Privileged Exec

Example To display the external RADIUS server details for the application-proxy whitelist feature, use the command:

```
awplus# show application-proxy whitelist server
```

Output Figure 51-12: Example output from **show application-proxy whitelist server**

```
awplus#show application-proxy whitelist server

Application Proxy Whitelist Details:

External Server Details:
  IP: 192.168.1.10
  Port: 2083
  Protection: TLS
  Trustpoint: None (Authentication disabled)

Proxy Details:
  IP: 172.31.0.5
  Status: Alive
```

- Related commands**
- [application-proxy whitelist enable](#)
 - [application-proxy whitelist server](#)
 - [show application-proxy whitelist interface](#)
 - [show application-proxy whitelist supplicant](#)

Command changes Version 5.4.9-0.1: command added

show application-proxy whitelist supplicant

Overview Use this command to display the current configuration and status for each supplicant attached to an application-proxy whitelist port.

Syntax `show application-proxy whitelist supplicant [interface <interface-list>|<mac-addr>|brief]`

Parameter	Description
<code>interface</code> <interface-list>	The interfaces or ports to display information about. An interface-list can be: <ul style="list-style-type: none">• a switchport (e.g. port1.0.4)• a static channel group (e.g. sa2)• a dynamic (LACP) channel group (e.g. po2)• a continuous range of ports separated by a hyphen (e.g. port1.0.1-1.0.4)• a comma-separated list (e.g. port1.0.1,port1.0.3-1.0.4). Do not mix port types in the same list. The specified interface must exist.
<mac-addr>	MAC (hardware) address of the supplicant. Entry format is HHHH.HHHH.HHHH (hexadecimal)
<code>brief</code>	Brief summary of the supplicant state.

Mode Privileged Exec

Example To display the supplicant information for all ports, use the command:

```
awplus# show application-proxy whitelist supplicant
```

To display the supplicant information for port1.0.4, use the command:

```
awplus# show application-proxy whitelist supplicant interface  
port1.0.4
```

Output Figure 51-13: Example output from **show application-proxy whitelist supplicant**

```
awplus#show application-proxy whitelist supplicant
Interface port1.0.4
  authenticationMethod: dot1x/mac/web
  Two-Step Authentication
    firstMethod: mac
    secondMethod: dot1x/web
  totalSupplicantNum: 1
  authorizedSupplicantNum: 1
    macBasedAuthenticationSupplicantNum: 0
    dot1xAuthenticationSupplicantNum: 0
    webBasedAuthenticationSupplicantNum: 1
    otherAuthenticationSupplicantNum: 0

Supplicant name: test
Supplicant address: 001c.233e.e15a
  authenticationMethod: WEB-based Authentication
  Two-Step Authentication:
    firstAuthentication: Pass - Method: mac
    secondAuthentication: Pass - Method: web
  portStatus: Authorized - currentId: 1
  abort:F fail:F start:F timeout:F success:T
  PAE: state: Authenticated - portMode: Auto
  PAE: reAuthCount: 0 - rxRespId: 0
  PAE: quietPeriod: 60 - maxReauthReq: 2
  BE: state: Idle - reqCount: 0 - idFromServer: 0
  CD: adminControlledDirections: in operControlledDirections: in
  CD: bridgeDetected: false
  KR: rxKey: false
  KT: keyAvailable: false - keyTxEnabled: false
  RADIUS server group (auth): radius
  RADIUS server (auth): 192.168.1.40
...
```

Related commands

- [application-proxy whitelist enable](#)
- [application-proxy whitelist server](#)
- [show application-proxy whitelist interface](#)
- [show application-proxy whitelist server](#)

Command changes Version 5.4.9-0.1: command added

show atmf

Overview Displays information about the current AMF node.

Syntax `show atmf [summary|tech|nodes|session]`

Parameter	Description
summary	Displays summary information about the current AMF node.
tech	Displays global AMF information.
nodes	Displays a list of AMF nodes together with brief details.
session	Displays information on an AMF session.

Default Only summary information is displayed.

Mode User Exec and Privileged Exec

Usage notes AMF uses internal VLANs to communicate between nodes about the state of the AMF network. Two VLANs have been selected specifically for this purpose. Once these have been assigned, they are reserved for AMF and cannot be used for other purposes

For information on filtering and saving command output, see the [“Getting Started with AlliedWare Plus” Feature Overview and Configuration Guide](#).

Example 1 To show summary information on AMF node_1 use the following command:

```
node_1# show atmf summary
```

Table 52: Output from the **show atmf summary** command

```
node_1#show atmf summary
ATMF Summary Information:

ATMF Status           : Enabled
Network Name          : Test_network
Node Name              : node_1
Role                   : Master
Restricted login       : Disabled
Current ATMF Nodes    : 3
```

Example 2 To show information specific to AMF nodes use the following command:

```
node_1# show atmf nodes
```

Example 3 The **show amf session** command displays all CLI (Command Line Interface) sessions for users that are currently logged in and running a CLI session.

To display AMF active sessions, use the following command:

```
node_1# show atmf session
```

For example, in the output below, node_1 and node_5 have active users logged in.

Table 53: Output from the **show atmf session** command

```
node_1#show atmf session

CLI Session Neighbors

Session ID           : 73518
Node Name            : node_1
PID                  : 7982
Link type            : Broadcast-cli
MAC Address          : 0000.0000.0000
Options              : 0
Our bits             : 0
Link State           : Full
Domain Controller    : 0
Backup Domain Controller : 0
Database Description Sequence Number : 00000000
First Adjacency      : 1
Number Events        : 0
DBE Retransmit Queue Length : 0
DBE Request List Length : 0
Session ID           : 410804
Node Name            : node_5
PID                  : 17588
Link type            : Broadcast-cli
MAC Address          : 001a.eb56.9020
Options              : 0
Our bits             : 0
Link State           : Full
Domain Controller    : 0
Backup Domain Controller : 0
Database Description Sequence Number : 00000000
First Adjacency      : 1
Number Events        : 0
DBE Retransmit Queue Length : 0
DBE Request List Length : 0
```

Example 4 The AMF tech command collects all the AMF commands, and displays them. You can use this command when you want to see an overview of the AMF network.

To display AMF technical information, use the following command:

```
node_1# show atmf tech
```

Table 54: Output from the **show atmf tech** command

```

node_1#show atmf tech
ATMF Summary Information:

ATMF Status           : Enabled
Network Name          : ATMF_NET
Node Name              : node_1
Role                   : Master
Current ATMF Nodes    : 8

ATMF Technical information:

Network Name           : ATMF_NET
Domain                 : node_1's domain
Node Depth             : 0
Domain Flags           : 0
Authentication Type    : 0
MAC Address            : 0014.2299.137d
Board ID               : 287
Domain State           : DomainController
Domain Controller      : node_1
Backup Domain Controller : node2
Domain controller MAC  : 0014.2299.137d
Parent Domain          : -
Parent Domain Controller : -
Parent Domain Controller MAC : 0000.0000.0000
Number of Domain Events : 0
Crosslink Ports Blocking : 0
Uplink Ports Waiting on Sync : 0
Crosslink Sequence Number : 7
Domains Sequence Number : 28
Uplink Sequence Number : 2
Number of Crosslink Ports : 1
Number of Domain Nodes : 2
Number of Neighbors : 5
Number of Non Broadcast Neighbors : 3
Number of Link State Entries : 1
Number of Up Uplinks : 0
Number of Up Uplinks on This Node : 0
DBE Checksum           : 84fc6
Number of DBE Entries : 0
Management Domain Ifindex : 4391
Management Domain VLAN : 4091
Management ifindex : 4392
Management VLAN : 4092
    
```

Table 55: Parameter definitions from the **show atmf tech** command

Parameter	Definition
ATMF Status	The Node's AMF status, either Enabled or Disabled.
Network Name	The AMF network that a particular node belongs to.

Table 55: Parameter definitions from the **show atmf tech** command (cont.)

Parameter	Definition
Node Name	The name assigned to a particular node.
Role	The role configured for this AMF device, either Master or Member.
Current ATMF Nodes	The count of AMF nodes in an AMF Network.
Node Address	An address used to access a remotely located node (.atmf).
Node ID	A unique identifier assigned to a Node on an AMF network.
Node Depth	The number of nodes in path from this node to level of the AMF root node. It can be thought of as the vertical depth of the AMF network from a particular node to the zero level of the AMF root node.
Domain State	The state of Node in a Domain in AMF network as Controller/Backup.
Recovery State	The AMF node recovery status. Indicates whether a node recovery is in progress on this device - Auto, Manual, or None.
Management VLAN	The VLAN created for traffic between Nodes of different domain (up/down links). <ul style="list-style-type: none"> • VLAN ID - In this example VLAN 4092 is configured as the Management VLAN. • Management Subnet - Network prefix for the subnet. • Management IP Address - The IP address allocated for this traffic. • Management Mask - The subnet mask used to create a subnet for this traffic (255.255.128.0).
Domain VLAN	The VLAN assigned for traffic between Nodes of same domain (crosslink). <ul style="list-style-type: none"> • VLAN ID - In this example VLAN 4091 is configured as the domain VLAN. • Domain Subnet. The subnet address used for this traffic. • Domain IP Address. The IP address allocated for this traffic. • Domain Mask. The subnet mask used to create a subnet for this traffic (255.255.128.0).
Device Type	The Product Series name.
ATMF Master	Whether the node is an AMF master node for its area ('Y' if it is and 'N' if it is not).
SC	The device configuration, one of C - Chassis (SBx8100 Series), S - Stackable (VCS) or N - Standalone.
Parent	The node to which the current node has an active uplink.
Node Depth	The number of nodes in the path from this node to the master node.

Related commands [show atmf detail](#)

show atmf area

Overview Use this command to display information about an AMF area. On AMF controllers, this command displays all areas that the controller is aware of. On remote AMF masters, this command displays the controller area and the remote local area. On gateways, this command displays the controller area and remote master area.

Syntax `show atmf area [detail] [<area-name>]`

Parameter	Description
detail	Displays detailed information
<area-name>	Displays information about master and gateway nodes in the specified area only.

Mode Privileged Exec

Example 1 To show information about all areas, use the command:

```
controller-1# show atmf area
```

The following figure shows example output from running this command on a controller.

Table 56: Example output from the **show atmf area** command on a Controller.

```
controller-1#show atmf area

ATMF Area Information:

* = Local area

Area          Area  Local  Remote  Remote  Node
Name          ID    Gateway Gateway Master   Count
-----
* NZ          1     Reachable  N/A     N/A     3
Wellington   2     Reachable  Reachable  Auth OK  120
Canterbury   3     Reachable  Reachable  Auth Error  -
SiteA-AREA   14    Unreachable  Unreachable  Unreachable  -
Auckland     100   Reachable  Reachable  Auth Start  -
Southland    120   Reachable  Reachable  Auth OK    54

Area count:      6                      Area node count:  177
```

The following figure shows example output from running this command on a remote master.

Table 57: Example output from the **show atmf area** command on a remote master.

```

Canterbury#show atmf area

  ATMF Area Information:

  * = Local area

Area          Area  Local      Remote      Remote      Node
Name          ID    Gateway    Gateway     Master      Count
-----
NZ            1     Reachable  N/A         N/A         -
* Canterbury  3     Reachable  N/A         N/A         40

Area count:      2                               Local area node count:  40
    
```

Table 58: Parameter definitions from the **show atmf area** command

Parameter	Definition
*	Indicates the area of the device on which the command is being run.
Area Name	The name of each area.
Area ID	The ID of the area.
Local Gateway	Whether the local gateway node is reachable or not.
Remote Gateway	Whether the remote gateway node is reachable or not. This is one of the following: <ul style="list-style-type: none"> Reachable, if the link has been established. Unreachable, if a link to the remote area has not been established. This could mean that a port or vlan is down, or that inconsistent VLANs have been configured using the switchport atmf-arealink command. N/A for the area of the controller or remote master on which the command is being run, because the gateway node on that device is local. Auth Start, which may indicate that the area names match on the controller and remote master, but the IDs do not match. Auth Error, which indicates that the areas tried to authenticate but there is a problem. For example, the passwords configured on the controller and remote master may not match, or a password may be missing on the remote master.? Auth OK, which indicates that area authentication was successful and you can now use the atmf select-area command.
Remote Master	Whether the remote master node is reachable or not. This is N/A for the area of the controller or remote master on which the command is being run, because the master node on that device is local.
Node Count	The number of nodes in the area.
Area Count	The number of areas controlled by the controller.
Area Node Count	The total number of nodes in the area.

Example 2 To show detailed information about the areas, use the command:

```
controller-1# show atmf area detail
```

The following figure shows example output from running this command.

Table 59: Output from the **show atmf area detail** command

```
controller-1#show atmf area detail

ATMF Area Detail Information:

Controller distance      : 0

Controller Id           : 21
Backup Available        : FALSE

Area Id                 : 2
Gateway Node Name       : controller-1
Gateway Node Id         : 342
Gateway Ifindex         : 6013
Masters Count           : 1
Master Node Name        : well-master (329)
Node Count              : 2

Area Id                 : 3
Gateway Node Name       : controller-1
Gateway Node Id         : 342
Gateway Ifindex         : 4511
Masters Count           : 2
Master Node Name        : cant1-master (15)
Master Node Name        : cant2-master (454)
Node Count              : 2
```

Related commands

- [show atmf area summary](#)
- [show atmf area nodes](#)
- [show atmf area nodes-detail](#)

show atmf area guests

Overview This command will display details of all guests that the controller is aware of.

Syntax `show atmf area guests [<area-name> [<node-name>]]`

Parameter	Description
<area-name>	The area name for guest information
<node-name>	The name of the node that connects to the guests.

Default n/a

Mode User Exec/Privileged Exec

Example 1 To display atmf area guest nodes on a controller, use the command,

```
GuestNode[1]#show atmf area guests
```

Output Figure 51-14: Example output from the **show atmf area guests** command

```
main-building Area Guest Node Information:
Device      MAC                               IP/IPv6
Type        Address                Parent      Port      Address
-----
-           0008.5d10.7635        x230       1.0.3     192.168.5.4
AT-TQ4600   eccd.6df2.da60        wireless-node1  1.0.4     192.168.5.3
-           0800.239e.f1fe        x230       1.0.4     192.168.4.8
AT-TQ4600   001a.eb3b.dc80        wireless-node2  1.0.7     192.168.4.12

main-building guest node count 4

GuestNode[1]#
```

Table 60: Parameters in the output from **show atmf area guests** command

Parameter	Description
Device Type	The device type as read from the guest node.
MAC Address	The MAC address of the guest-node
Parent	The device that directly connects to the guest-node
Port	The port number on the parent node that connects to the guest node.
IP/IPv6	The IP or IPv6 address of the guest node.

Related commands

- show atmf area
- show atmf area nodes
- show atmf backup guest
- show atmf area guests-detail

show atmf area guests-detail

Overview This command displays the local and remote guest information from an AMF controller.

Syntax `show atmf area guests-detail [<area-name> [<node-name>]]`

Parameter	Description
<area-name>	The name assigned to the AMF area. An area is an AMF network that is under the control of an AMF Controller.
<node-name>	The name assigned to the network node.

Default n/a.

Mode Privileged Exec

Example To display detailed information for all guest nodes attached to “node1”, which is located within the area named “northern”, use the following command:

```
AMF_controller#show atmf area guests-detail northern node1
```

Output Figure 51-15: Example output from the **show atmf guest detail** command.

```
#show atmf guest detail

Node Name           : Node1
Port Name           : port1.0.5
Ifindex             : 5005
Guest Description   : tq4600
Device Type         : AT-TQ4600
Configuration Mismatch : No
Backup Supported    : Yes
MAC Address         : eccd.6df2.da60
IP Address          : 192.168.4.50
IPv6 Address        : Not Set
HTTP Port           : 80
Firmware Version    :
Node Name           : poe
Port Name           : port1.0.6
Ifindex             : 5006
Guest Description   : tq3600
Device Type         : AT-TQ2450
Configuration Mismatch : No
Backup Supported    : Yes
MAC Address         : 001a.eb3b.cb80
IP Address          : 192.168.4.9
IPv6 Address        : Not Set
HTTP Port           : 80
Firmware Version    :
```

Table 61: Parameters shown in the output of the **show atmf guest detail** command

Parameter	Description
Node Name	The name of the guest's parent node.
Port Name	The port on the parent node that connects to the guest.
IFindex	An internal index number that maps to the port number on the parent node.
Guest Description	A brief description of the guest node as manually entered into the description (interface) command for the guest node port on the parent node.
Device Type	The device type as supplied by the guest node itself.
Backup Supported	Indicates whether AMF supports backup of this guest node.
MAC Address	The MAC address of the guest node.
IP Address	The IP address of the guest node.
IPv6 Address	The IPv6 address of the guest node.
HTTP Port	The HTTP port enables you to specify a port when enabling http to allow a URL for the http user interface of a Guest Node. This is determined by the http-enable command.
Firmware Version	The firmware version that the guest node is currently running.

Related commands [show atmf area nodes-detail](#)
[show atmf area guests](#)

show atmf area nodes

Overview Use this command to display summarized information about an AMF controller's remote nodes.

Note that this command can only be run from a controller node.

Syntax `show atmf area nodes <area-name> [<node-name>]`

Parameter	Description
<code><area-name></code>	Displays information about nodes in the specified area.
<code><node-name></code>	Displays information about the specified node.

Mode Privileged Exec

Usage notes If you do not limit the output to a single area or node, this command lists all remote nodes that the controller is aware of. This can be a very large number of nodes.

Example To show summarized information for all the nodes in area 'Wellington', use the command:

```
controller-1# show atmf area nodes Wellington
```

The following figure shows partial example output from running this command.

Table 62: Output from the `show atmf area nodes Wellington` command

```
controller-1#show atmf area nodes Wellington

Wellington Area Node Information:
Node          Device          ATMF          Parent          Node
Name          Type            Master  SC            Domain          Depth
-----
well-gate     x230-18GP      N           N           well-master     1
well-master   AT-x930-28GPX  Y           N           none            0

Wellington node count 2
```

Table 63: Parameter definitions from the `show atmf area nodes` command

Parameter	Definition
Node Name	The name assigned to a particular node.
Device Type	The Product series name.
ATMF Master	Whether the node is an AMF master node for its area ('Y' if it is and 'N' if it is not).

Table 63: Parameter definitions from the **show atmf area nodes** command

Parameter	Definition
SC	The device configuration, one of C - Chassis (SBx8100 series), S - Stackable (VCS) or N - Standalone.
Parent Domain	The node to which the current node has an active uplink.
Node Depth	The number of nodes in the path from this node to the master node.

**Related
commands**

[show atmf area](#)

[show atmf area nodes-detail](#)

show atmf area nodes-detail

Overview Use this command to display detailed information about an AMF controller's remote nodes.

Note that this command can only be run from a controller node.

Syntax `show atmf area nodes-detail <area-name> [<node-name>]`

Parameter	Description
<code><area-name></code>	Displays detailed information about nodes in the specified area.
<code><node-name></code>	Displays detailed information about the specified node.

Mode Privileged Exec

Usage notes If you do not limit the output to a single area or node, this command displays information about all remote nodes that the controller is aware of. This can be a very large number of nodes.

Example To show information for all the nodes in area 'Wellington', use the command:

```
controller-1# show atmf area nodes-detail Wellington
```

The following figure shows partial example output from running this command.

Table 64: Output from the **show atmf area nodes-detail Wellington** command

```
controller-1#show atmf area nodes-detail Wellington

Wellington Area Node Information:
Node name well-gate
Parent node name : well-master
Domain id      : well-gate's domain
Board type    : 368
Distance to core : 1
Flags        : 50
Extra flags   : 0x00000006
MAC Address   : 001a.eb56.9020

Node name well-master
Parent node name : none
Domain id      : well-master's domain
Board type    : 333
Distance to core : 0
Flags        : 51
Extra flags   : 0x0000000c
MAC Address   : eccd.6d3f.fef7

...
```

Table 65: Parameter definitions from the **show atmf area nodes-detail** command

Parameter	Definition
Node name	The name assigned to a particular node.
Parent node name	The node to which the current node has an active uplink.
Domain id	The name of the domain the node belongs to.
Board type	The Allied Telesis code number for the device.
Distance to core	The number of nodes in the path from the current node to the master node in its area.
Flags	Internal AMF information
Extra flags	Internal AMF information
MAC Address	The MAC address of the current node

Related commands [show atmf area](#)
[show atmf area nodes](#)

show atmf area summary

Overview Use this command to display a summary of IPv6 addresses used by AMF, for one or all of the areas controlled by an AMF controller.

Syntax `show atmf area summary [<area-name>]`

Parameter	Description
<code><area-name></code>	Displays information for the specified area only.

Mode Privileged Exec

Example 1 To show a summary of IPv6 addresses used by AMF, for all of the areas controlled by controller-1, use the command:

```
controller-1# show atmf area summary
```

The following figure shows example output from running this command.

Table 66: Output from the **show atmf area summary** command

```
controller-1#show atmf area summary

ATMF Area Summary Information:

Management Information
Local IPv6 Address           : fd00:4154:4d46:1::15

Area Information
Area Name                    : NZ (Local)
Area ID                      : 1
Area Master IPv6 Address     : -

Area Name                    : Wellington
Area ID                      : 2
Area Master IPv6 Address     : fd00:4154:4d46:2::149

Area Name                    : Canterbury
Area ID                      : 3
Area Master IPv6 Address     : fd00:4154:4d46:3::f

Area Name                    : Auckland
Area ID                      : 100
Area Master IPv6 Address     : fd00:4154:4d46:64::17
Interface                    : vlink2000
```

Related commands

- [show atmf area](#)
- [show atmf area nodes](#)
- [show atmf area nodes-detail](#)

show atmf authorization

Overview Use this command on an AMF master to display the authorization status of other AMF members and masters on the network.

On an AMF controller this command will show the authorization status of remote area AMF masters.

Syntax `show atmf authorization {current|pending|provisional}`

Parameter	Description
current	Show the status of all authorized nodes.
pending	Show the status of unauthorized nodes in the pending queue. These are nodes that enabled secure mode with <code>atmf secure-mode</code> but have not yet been authorized with <code>atmf authorize</code> .
provisional	Show the status of provisionally authorized nodes. These are nodes that have been provisioned with <code>atmf authorize provision</code> .

Mode Privileged Exec

Example To display all authorized AMF nodes on an AMF controller or AMF master, use the command:

```
awplus# show atmf authorization current
```

To display AMF nodes which are requesting authorization on an AMF controller or AMF master, use the command:

```
awplus# show atmf authorization pending
```

To display AMF nodes which have provisional authorization, use the command:

```
awplus# show atmf authorization provisional
```

Output Figure 51-16: Example output from **show atmf authorization current**

NZ Authorized Nodes:		
Node Name	Signer	Expires
-----	-----	-----
master_1	master_1	4 Mar 2017
area_1_node_1	master_1	4 Mar 2017
area_1_node_2	master_1	4 Mar 2017

Table 51-1: Parameters in the output from **show atmf authorization current**

Parameter	Description
Node Name	AMF node name of the authorized node.
Signer	Name of the AMF master that authorized the node.
Expires	Expiry date of the authorization. Authorization expiry time is set using <code>atmf secure-mode certificate expiry</code> .

Output Figure 51-17: Example output from **show atmf authorization pending**

```

Pending Authorizations:

NZ Requests:
Node Name           Product           Parent Node       Interface
-----
area_1_node_3      x230-18GP        master_1          port1.2.9
area_1_node_4      x510-52GTX       master_1          sal
    
```

Table 51-2: Parameters in the output from **show atmf authorization pending**

Parameter	Description
Node Name	Name of the node that is requesting authorization.
Product	Product name.
Parent Node	Authorization authority of the requesting node.
Interface	Interface that the authorization request came in on.

Output Figure 51-18: Example output from **show atmf authorization provisional**

```

ATMF Provisional Authorization:

Area - Node Name           Start           Timeout
or MAC Address           Interface       Time           Minutes
-----
3333.4444.5555             5 Sep 2016 02:35:54   3
1111.2222.3333             5 Sep 2016 02:35:24   60
NZ - blue                   port1.0.3        5 Sep 2016 02:35:06   60
    
```

Table 51-3: Parameters in the output from **show atmf authorization provisional**

Parameter	Description
Area - Node Name or MAC Address	MAC address or node name of the node that has been provisionally authorized.
Interface	Interface that the node has been provisioned on.
Start Time	Time the node was provisioned.
Timeout Minutes	Length of time from Start Time until the provisional authorization expires.

**Related
commands**

[atmf authorize](#)
[atmf authorize provision](#)
[atmf secure-mode](#)
[clear atmf secure-mode certificates](#)
[show atmf](#)
[show atmf secure-mode](#)
[show atmf secure-mode certificates](#)

**Command
changes**

Version 5.4.7-0.3: command added

show atmf backup

Overview This command displays information about AMF backup status for all the nodes in an AMF network. It can only be run on AMF master and controller nodes.

Syntax

```
show atmf backup
show atmf backup logs
show atmf backup server-status
show atmf backup synchronize [logs]
```

Parameter	Description
logs	Displays detailed log information.
server-status	Displays connectivity diagnostics information for each configured remote file server.
synchronize	Display the file server synchronization status
logs	For each remote file server, display the logs for the last synchronization

Mode Privileged Exec

Example 1 To display the AMF backup information, use the command:

```
node_1# show atmf backup
```

To display log messages to do with backups, use the command:

```
node_1# show atmf backup logs
```

Table 51-4: Output from **show atmf backup**

```
Node_1# show atmf backup
ScheduledBackup .....Enabled
  Schedule.....1 per day starting at 03:00
  Next Backup Time...04 May 2019 03:00
Backup Bandwidth .....Unlimited
Backup Media.....SD (Total 1974.0 MB, Free197.6MB)
Current Action.....Starting manual backup
Started.....04 May 2019 10:08
CurrentNode.....atmf_testbox1
Backup Redundancy ...Enabled
  Local media .....SD (Total 3788.0MB, Free 3679.5MB)
  State .....Active
```

Node Name	Date	Time	In ATMF	On Media	Status
atmf_testbox1	04 May 2019	09:58:59	Yes	Yes	In Progress
atmf_testbox2	04 May 2019	10:01:23	Yes	Yes	Good

Table 51-5: Output from **show atmf backup logs**

```
Node_1#show atmf backup logs

Backup Redundancy ..... Enabled
Local media ..... SD (Total 3788.0MB, Free 1792.8MB)
State ..... Inactive (Remote file server is not available)

Log File Location: card:/atmf/ATMF/logs/rsync_<node name>.log

Node
Name Log Details
-----
atmf_testbox
2019/05/04 18:16:51 [9045] receiving file list
2019/05/04 18:16:51 [9047] .d..t.... flash/
2019/05/04 18:16:52 [9047] >f+++++++ flash/a.rel
```

Example 2 To display the AMF backup synchronization status, use the command:

```
node_1# show atmf backup synchronize
```

To display log messages to do with synchronization of backups, use the command:

```
node_1# show atmf backup synchronize logs
```

Table 51-6: Output from **show atmf backup synchronize**

```
Node_1#show atmf backup synchronize

ATMF backup synchronization:

* = Active file server

  Id  Date           Time           Status
-----
  1   04 May 2016    22:25:57      Synchronized
* 2   -              -              Active
```

Table 51-7: Output from **show atmf backup synchronize logs**

```
Node_1#show atmf backup synchronize logs

Id    Log Details
-----
1     2019/05/04 22:25:54 [8039] receiving file list
      2019/05/04 22:25:54 [8039] >f..t.... backup_Box1.info
      2019/05/04 22:25:54 [8039] sent 46 bytes received 39 bytes total size 40
```

Example 3 To display the AMF backup information with the optional parameter **server-status**, use the command:

```
Node_1# show atmf backup server-status
```

```

Node1#sh atmf backup server-status

Id    Last Check    State
-----
1     186 s        File server ready
2     1 s          SSH no route to host
    
```

Table 52: Parameter definitions from the **show atmf backup** command

Parameter	Definition
Scheduled Backup	Indicates whether AMF backup scheduling is enabled or disabled.
Schedule	Displays the configured backup schedule.
Next Backup Time	Displays the date and time of the next scheduled.
Backup Media	The current backup medium in use. This will be SD or NONE. SD card only (and not USB) is supported for AMF backup. Utilized and available memory (MB) will be indicated if backup media memory is present.
Current Action	The task that the AMF backup mechanism is currently performing. This will be a combination of either (Idle, Starting, Doing, Stopping), or (manual, scheduled).
Started	The date and time that the currently executing task was initiated in the format DD MMM YYYY HH:MM
Current Node	The name of the node that is currently being backed up.
Backup Redundancy	Whether backup redundancy is enabled or disabled.
Local media	The local media to be used for backup redundancy; SD, USB, INTERNAL, or NONE, and total and free memory available on the media.
State	Whether SD or USB media is installed and available for backup redundancy. May be Active (if backup redundancy is functional—requires both the local redundant backup media and a remote server to be configured and available) or Inactive.
Node Name	The name of the node that is storing backup data - on its backup media.
Date	The data of the last backup in the format DD MMM YYYY.
Time	The time of the last backup in the format HH:MM:SS.
In ATMF	Whether the node shown is active in the AMF network, (Yes or No).
On Media	Whether the node shown has a backup on the backup media (Yes or No).

Table 52: Parameter definitions from the **show atmf backup** command (cont.)

Parameter	Definition
Status	The output can contain one of four values: <ul style="list-style-type: none">• “-” meaning that the status file cannot be found or cannot be read.• “Errors” meaning that there are issues - note that the backup may still be deemed successful depending on the errors.• “Stopped” meaning that the backup attempt was manually aborted.• “Good” meaning that the backup was completed successfully.• “In Progress” meaning that the backup is currently running on that node.
Log File Location	All backup attempts will generate a result log file in the identified directory based on the node name. In the above example this would be: card:/amf/office/logs/rsync_amf_testbox1.log.
Log Details	The contents of the backup log file.
server-status	Displays connectivity diagnostics information for each configured remove file server.

For information on filtering and saving command output, see the [“Getting Started with AlliedWare Plus” Feature Overview and Configuration Guide](#).

Related commands [show atmf](#)
[atmf network-name](#)

show atmf backup area

Overview Use this command to display backup status information for the master nodes in one or more areas.

Note that this command is only available on AMF controllers.

Syntax `show atmf backup area [<area-name> [<node-name>]] [logs]`

Parameter	Description
logs	Displays the logs for the last backup of each node.
<area-name>	Displays information about nodes in the specified area.
<node-name>	Displays information about the specified node.

Mode Privileged Exec

Example To show information about backups for an area, use the command:

```
controller-1# show atmf backup area
```

Table 53: Output from the **show atmf backup area** command

```

controller-1#show atmf backup area

Scheduled Backup ..... Enabled
  Schedule ..... 12 per day starting at 14:30
  Next Backup Time .... 15 Oct 2016 04:30
Backup Bandwidth ..... Unlimited
Backup Media ..... FILE SERVER 1 (Total 128886.5MB, Free 26234.2MB)
Server Config .....
 * 1 ..... Configured (Mounted, Active)
   Host ..... 10.37.74.1
   Username ..... root
   Path ..... /tftpboot/backups_from_controller-1
   Port ..... -
  2 ..... Configured (Unmounted)
   Host ..... 10.37.142.1
   Username ..... root
   Path ..... -
   Port ..... -
Current Action ..... Idle
  Started ..... -
  Current Node ..... -

Backup Redundancy ..... Enabled
  Local media ..... USB (Total 7604.0MB, Free 7544.0MB)
  State ..... Active

Area Name          Node Name          Id   Date           Time           Status
-----
Wellington         camry              1    14 Oct 2016    02:30:22      Good
Canterbury         corona             1    14 Oct 2016    02:30:23      Good
Canterbury         Avensis           1    14 Oct 2016    02:30:22      Good
Auckland           RAV4              1    14 Oct 2016    02:30:23      Good
Southland          MR2               1    14 Oct 2016    02:30:24      Good
    
```

- Related commands**
- [atmf backup area-masters enable](#)
 - [show atmf area](#)
 - [show atmf area nodes-detail](#)
 - [switchport atmf-arealink](#)

show atmf backup guest

Overview This command displays backup status information of guest nodes in an AMF network. This command can only be run on a device configured as an AMF Master and has an AMF guest license.

Syntax `show atmf backup guest [<node-name> [<guest-port>]] [logs]`

Parameter	Description
<node-name>	The name of parent guest node
<guest-port>	The port number on the parent node

Mode User Exec/Privileged Exec

Example On the switch named x930-master, to display information about the AMF backup guest status, use the command:

```
x930-master# show atmf backup guest
```

Output Figure 51-19: Example output from **show atmf backup guest**

```
x930-master#sh atmf backup guest
Guest Backup ..... Enabled
Scheduled Backup ..... Disabled
  Schedule ..... 1 per day starting at 03:00
  Next Backup Time ... 20 Jan 2016 03:00
Backup Bandwidth ..... Unlimited
Backup Media ..... FILE SERVER 2 (Total 655027.5MB,
                               Free 140191.5MB)
Server Config
  1 ..... Configured (Mounted)
  Host ..... 11.0.24.1
  Username ..... bob
  Path ..... guest-project
  Port ..... -
* 2 ..... Configured (Mounted, Active)
  Host ..... 11.0.24.1
  Username ..... bob
  Path ..... guest-project-second
  Port.....-
Current Action .....Idle
Started ..... -
Current Node ..... -
Backup Redundancy ...Enabled
Local media ..... USB (Total 7376.0MB, Free 7264.1MB)
State ..... Active
```

Parent Node Name	Port Name	Id	Date	Time	Status
x230	port1.0.4	2	19 Jan 2016	22:21:46	Good
		1	19 Jan 2016	22:21:46	Good
		USB	19 Jan 2016	22:21:46	Good

Table 51-1: Parameters in the output from **show atmf backup guest**

Parameter	Description
Guest Backup	The status of the guest node backup process
Scheduled Backup	The timing configured for guest backups.
Schedule	Displays the configured backup schedule.
Next Backup Time	The time the next backup process will be initiated.
Backup Bandwidth	The bandwidth limit applied to the backup data flow measured in kilo Bytes /second. Note that unlimited means there is no limit set specifically for the backup data flow.
Backup Media	Detail of the memory media used to store the backup files and the current memory capacity available.

- Related commands**
- show atmf backup area
 - show atmf backup
 - show atmf links guest
 - show atmf nodes
 - show atmf backup guest
 - atmf backup guests delete
 - atmf backup guests enable

show atmf container

Overview Use this command to display information about the AMF containers created on a Virtual AMF Appliance (VAA).

An AMF container is an isolated instance of AlliedWare Plus with its own network interfaces, configuration, and file system. The features available inside an AMF container are a sub-set of the features available on the host VAA. These features enable the AMF container to function as a uniquely identifiable AMF master and allows for multiple tenants (up to 60) to run on a single VAA host. See the [AMF Feature Overview and Configuration Guide](#) for more information on running multiple tenants on a single VAA host.

Syntax `show atmf container [detail] [<container-name>]`

Parameter	Description
detail	Show detailed information.
<container-name>	The name of the AMF container you wish to display information for.

Mode Privileged Exec

Output Figure 51-20: Example output from **show atmf container**

```
awplus#show atmf container
ATMF Container Information:
  Container      Area      Bridge  State   Memory   CPU%
-----
  vac-wlg-1     wlg       br1     running 70.3 MB  1.2
  vac-akl-1     ak1       br2     stopped 0 bytes  0.0
  vac-nsn-1     nsn       br3     running 53.2 MB  0.7
Current ATMF Container count: 3
```

Figure 51-21: Example output from **show atmf container vac-wlg-1**

```
awplus#show atmf container vac-wlg-1
ATMF Container Information:
  Container      Area      Bridge  State   Memory   CPU%
-----
  vac-wlg-1     wlg       br1     running 70.3 MB  1.2
Current ATMF Container count: 1
```

Table 51-2: Parameters in the output from **show atmf container**

Parameter	Description
Container	Name of the AMF container.
Area	Name of the area the container is in.
Bridge	Name of the bridge connecting the container to the physical network.
State	Container state, <code>running</code> or <code>stopped</code> . This is set with the <code>state</code> command.
Memory	The amount of memory the container is using on the VAA host.
CPU%	The percentage of CPU time the container is using on the VAA, at the time the show command is run.

Figure 51-22: Example output from **show atmf container detail vac-wlg-1**

```
awplus#show atmf container detail vac-wlg-1

ATMF Container Information:

Name: vac-wlg-1
State: RUNNING
PID: 980
IP: 172.31.0.1
IP: 192.168.0.2
IP: fd00:4154:4d46:3c::1
CPU use: 3.95 seconds
Memory use: 67.07 MiB
Memory use: 0 bytes
Link: vethP31UFA
TX bytes: 166.01 KiB
RX bytes: 141.44 KiB
Total bytes: 307.45 KiB
Link: vethYCT7BB
TX bytes: 674.27 KiB
RX bytes: 698.27 KiB
Total bytes: 1.34 MiB
```

Table 51-3: Parameters in the output from **show atmf container detail**

Parameter	Description
Name	Name of the AMF container.
State	Container state, <code>RUNNING</code> or <code>STOPPED</code> . This is set with the <code>state</code> command.

Table 51-3: Parameters in the output from **show atmf container detail** (cont.)

Parameter	Description
PID	Internal container id.
IP	This lists the IP addresses used by the container. These include the eth1 IP address and the AMF management IP address.
CPU use	The CPU usage of the container since it was enabled.
Memory use	Container memory usage.
Link	Each container has two links: <ol style="list-style-type: none">1 An AMF area-link, this connects the container to the AMF controller and uses virtual interface eth0 on the AMF container.2 A bridged L2 network link, this connects the container to the outside world and uses the virtual interface eth1 on the AMF container. See the AMF Feature Overview and Configuration_Guide for more information on these links.
TX/RX bytes	Bytes sent and received on a link.
Total bytes	Total bytes transferred on a link.

Related commands

- [area-link](#)
- [atmf area](#)
- [atmf area password](#)
- [atmf container](#)
- [atmf container login](#)
- [bridge-group \(amf-container\)](#)
- [description \(amf-container\)](#)
- [state](#)

Command changes

Version 5.4.7-0.1: command added

show atmf detail

Overview This command displays details about an AMF node. It can only be run on AMF master and controller nodes.

Syntax show atmf detail

Parameter	Description
detail	Displays output in greater depth.

Mode Privileged Exec

Example 1 To display the AMF node1 information in detail, use the command:

```
controller-1# show atmf detail
```

A typical output screen from this command is shown below:

```
atmf-1#show atmf detail
ATMF Detail Information:

Network Name           : Test_network
Network Mtu           : 1300
Node Name              : controller-1
Node Address           : controller-1.atmf
Node ID                : 342
Node Depth             : 0
Domain State           : BackupDomainController
Recovery State         : None
Recovery Over ETH Ports : Disabled
Log Verbose Setting    : Verbose
Topology GUI           : Disabled

Management VLAN
VLAN ID                : 4000
Management Subnet     : 172.31.0.0
Management IP Address : 172.31.1.86
Management Mask       : 255.255.128.0
Management IPv6 Address : fd00:4154:4d46:1::156
Management IPv6 Prefix Length : 64

Domain VLAN
VLAN ID                : 4091
Domain Subnet          : 172.31.128.0
Domain IP Address      : 172.31.129.86
Domain Mask            : 255.255.128.0
```

Table 52: Parameter definitions from the **show atmf detail** command

Parameter	Definition
Network MTU	The network MTU for the ATMF network.
Network Name	The AMF network that a particular node belongs to.
Node Name	The name assigned to a particular node.
Node Address	An address used to access a remotely located node. This is simply the Node Name plus the dotted suffix atmf (.atmf).
Node ID	A unique identifier assigned to a node on an AMF network.
Node Depth	The number of nodes in the path from this node to the level of the AMF root node. It can be thought of as the vertical depth of the AMF network from a particular node to the zero level of the AMF root node.
Domain State	The state of a node in a Domain in an AMF network as Controller/Backup.
Recovery State	The AMF node recovery status. Indicates whether a node recovery is in progress on this device - Auto, Manual, or None.
Recovery Over ETH Ports	Allow AMF recovery over the Eth port on an AR-series device.
Log Verbose Setting	The state of the <code>atmf log-verbose</code> command.
Topology GUI	This feature allows your AMF network to interact with Vista Manager EX and must be enabled on your AMF master.
Management VLAN	The VLAN created for traffic between nodes of different domain (up/down links). <ul style="list-style-type: none"> • VLAN ID - in this example VLAN 4092 is configured as the Management VLAN. • Management Subnet - the network prefix for the subnet. • Management IP Address - the IP address allocated for this traffic. • Management Mask - the subnet mask used to create a subnet for this traffic (255.255.128.0).
Domain VLAN	The VLAN assigned for traffic between nodes of the same domain (crosslink). <ul style="list-style-type: none"> • VLAN ID - in this example VLAN 4091 is configured as the domain VLAN. • Domain Subnet - the subnet address used for this traffic. • Domain IP Address - the IP address allocated for this traffic. • Domain Mask - the subnet mask used to create a subnet for this traffic (255.255.128.0).
Node Depth	The number of nodes in the path from this node to the core domain.

show atmf group

Overview This command can be used to display the group membership within to a particular AMF node. It can also be used with the working-set command to display group membership within a working set.

Each node in the AMF is automatically added to the group that is appropriate to its hardware architecture, e.g. x510, x230. Nodes that are configured as masters are automatically assigned to the master group.

You can create arbitrary groups of AMF members based on your own selection criteria. You can then assign commands collectively to any of these groups.

Syntax `show atmf group [user-defined|automatic]`

Parameter	Description
<code>user-defined</code>	User-defined-group information display.
<code>automatic</code>	Automatic group information display.

Default All groups are displayed

Mode Privileged Exec

Example 1 To display group membership of node2, use the following command:

```
node2# show atmf group
```

A typical output screen from this command is shown below:

```
ATMF group information

master, x510

node2#
```

This screen shows that node2 contains the groups **master** and **x510**. Note that although the node also contains the implicit groups, these do not appear in the show output.

Example 2 The following commands (entered on *node2*) will display all the automatic groups within the working set containing *node1* and all nodes that have been pre-defined to contain the *sysadmin* group:

First define the working-set:

```
node1# #atmf working-set node1 group sysadmin
```

A typical output screen from this command is shown below:

```

ATMF group information

master, poe, x8100

=====
node1, node2, node3, node4, node5, node6:
=====

ATMF group information

sysadmin, x8100

AMF_NETWORK[6]#
    
```

This confirms that the six nodes (*node1* to *node6*) are now members of the working-set and that these nodes reside within the *AMF-NETWORK*.

Note that to run this command, you must have previously entered the command [atmf working-set](#) on page 2606. This can be seen from the network level prompt, which in this case is *AMF_NETWORK[6]#*.

Table 53: Sample output from the **show atmf group** command for a working set.

```

AMF_NETWORK[6]#show atmf group
=====
node3, node4, node5, node6:
=====

ATMF group information

edge_switches, x510
    
```

Table 54: Parameter definitions from the **show atmf group** command for a working set

Parameter	Definition
ATMF group information	Displays a list of nodes and the groups that they belong to, for example: <ul style="list-style-type: none"> • master - Shows a common group name for Nodes configured as AMF masters. • Hardware Arch - Shows a group for all Nodes sharing a common Hardware architecture, e.g. x8100, x230, for example. • User-defined - Arbitrary groups created by the user for AMF nodes.

show atmf group members

Overview This command will display all group memberships within an AMF working-set. Each node in the AMF working set is automatically added to automatic groups which are defined by hardware architecture, e.g. x510, x230. Nodes that are configured as masters are automatically assigned to the master group. Users can define arbitrary groupings of AMF members based on their own criteria, which can be used to select groups of nodes.

Syntax `show atmf group members [user-defined|automatic]`

Parameter	Description
user-defined	User defined group membership display.
automatic	Automatic group membership display.

Mode Privileged Exec

Example To display group membership of all nodes in a working-set, use the command:

```
ATMF_NETWORK[9]# show atmf group members
```

Table 55: Sample output from the **show atmf group members** command

```
ATMF Group membership
Automatic          Total
Groups            Members  Members
-----
master            1        Building_1
poe               1        HW_Team1
x510              3        SW_Team1 SW_Team2 SW_Team3
x930              1        HW_Team1
x8100            2        Building_1 Building_2

ATMF Group membership
User-defined       Total
Groups            Members  Members
-----
marketing         1        Bld1_Floor_1
software          3        SW_Team1 SW_Team2 SW_Team3
```

Table 56: Parameter definitions from the **show atmf group members** command

Parameter	Definition
Automatic Groups	Lists the Automatic Groups and their nodal composition. The sample output shows AMF nodes based on the same Hardware type or belonging to the same Master group.
User-defined Groups	Shows the grouping of AMF nodes in user defined groups.
Total Members	Shows the total number of members in each group.
Members	Shows the list of AMF nodes in each group.

Related commands

- [show atmf group](#)
- [show atmf](#)
- [atmf group \(membership\)](#)

show atmf guests

Overview This command is available on any AMF master or controller in the network. It displays a summary of the AMF guest nodes that exist in the AMF network, including device type, parent node, and IP address.

Syntax show atmf guests

Mode User Exec/Privileged Exec

Usage notes Use this command to display all guest nodes in a network. If you want to see only the guests attached to a single node, use the [show atmf links guest](#) command, which shows information about the guest nodes and also about their link to their parent node.

Example To display the AMF guest output, use the command:

```
awplus# show atmf guests
```

Output Figure 51-23: Example output from the **show atmf guests** command

```
master#show atmf guests

Guest Information:

Device          Device          Parent          Guest          IP/IPv6
Name            Type            Node            Port            Address
-----
node1-2.0.1     x600-24Ts      node1           2.0.1           192.168.2.10
wireless-zone1 AT-TQ4600      node2           1.0.1           192.168.1.10
wireless-zone2 AT-TQ4600      node2           1.0.2           192.168.1.12

Current ATMF guest node count 3
```

Table 57: Parameters shown in the output of the **show atmf guests** command

Parameter	Description
Device Name	The name that is discovered from the device, or failing that, a name that is auto-assigned by AMF. The auto-assigned name consists of: <parent node name>-<attached port number> You can change this by configuring a description on the port.
Device Type	The product name of the guest node, which is discovered from the device. If no device type can be discovered, this shows the name of the AMF guest-class that has been assigned to the guest node by the atmf guest-class command.

Table 57: Parameters shown in the output of the **show atmf guests** command

Parameter	Description
Parent Node	The name of the AMF node that directly connects to the guest node.
Guest Port	The port on the parent node that directly connects to the guest node.
IP/IPv6 Address	The address discovered from the node, or statically configured on the parent node's attached port.

**Related
commands**

[atmf guest-class](#)
[switchport atmf-guestlink](#)
[show atmf backup guest](#)
[show atmf links guest](#)

show atmf guests detail

Overview This command is available on any AMF master in the network. It displays details about the AMF guest nodes that exist in the AMF network, such as device type, IP address, MAC address etc.

Syntax `show atmf guests detail [<node-name>] [<guest-port>]`

Parameter	Description
<node-name>	The name of the guest node's parent.
<guest-port>	The port name on the parent node.

Mode User Exec/Privileged Exec

Usage notes If you want to see only the guests attached to a single node, you can use either:

- this command and specify the node name, or
- [show atmf links guest detail](#), which shows information about the guest nodes and also about their link to their parent node.

Note that the parameters that are displayed depend on the guest node's model.

Example To display the AMF guest output, use the command:

```
awplus# show atmf guests detail
```

Output Figure 51-24: Example output from **show atmf guests detail**

```
master#show atmf guests detail

ATMF Guest Node Information:

Node Name           : master
Port Name           : port1.0.9
Ifindex             : 5009
Guest Description   : red-1.0.9
Device Type         : x600-24Ts
Backup Supported    : No
MAC Address         : 0000.cd38.0c4d
IP Address          : 192.168.1.5
IPv6 Address        : Not Set
HTTP Port           : 0
Firmware Version    : 5.4.2-0.1
```

Node Name	: node1
Port Name	: port1.0.13
Ifindex	: 5013
Guest Description	: node1-1.0.13
Device Type	: AT-TQ4600
Backup Supported	: Yes
MAC Address	: eccd.6df2.daa0
IP Address	: 192.168.5.6
IPv6 Address	: Not Set
HTTP Port	: 80
Firmware Version	: 3.1.0 B01

Table 58: Parameters in the output from **show atmf guests detail**.

Parameter	Description
Node Name	The name of the parent node, which is the AMF node that directly connects to the guest node.
Port Name	The port on the parent node that connects to the guest.
IfIndex	An internal index number that maps to the port number on the parent node.
Guest Description	A description that is discovered from the device, or failing that, auto-assigned by AMF. The auto-assigned name consists of: <parent node name>-<attached port number>. You can change this by configuring a description on the port.
Device Type	The product name of the guest node, which is discovered from the device. If no device type can be discovered, this shows the name of the AMF guest-class that has been assigned to the guest node by the atmf guest-class command.
Username	The user name configured on the guest node.
Backup Supported	Whether the guest node supports AMF backup functionality.
MAC Address	The MAC address of the guest node.
IP Address	The IP address of the guest node.
IPv6 Address	The IPv6 address of the guest node.
Firmware Version	The version of the firmware operating on the guest node.
HTTP port	The HTTP port as specified with the http-enable command when defining a guest class. You can set this if the guest node provides an HTTP user interface on a non-standard port (any port other than port 80).

**Related
commands** `atmf guest-class`
 `switchport atmf-guestlink`
 `show atmf backup guest`

show atmf links

Overview This command displays information about AMF links on a switch. The display output contains link status state information.

Syntax `show atmf links [brief]`

Parameter	Description
brief	A brief summary of AMF links, their configuration and status.

Mode User Exec and Privileged Exec

Usage notes The **show atmf links** and **show atmf links brief** commands both produce a table of summarized link information. For a more detailed view use the [show atmf links detail](#) command.

This command does not show links that are configured on provisioned ports.

Example To display a brief summary of the AMF links, use the following command:

```
node-1# show atmf links brief
```

Figure 51-25: Example output from **show atmf links brief**

```
Example-core# show atmf links
ATMF Link Brief Information:
Local      Link      Link      ATMF      Adjacent      Adjacent      Link
Port       Type      Status    State     Node          Ifindex       State
-----
1.0.10     Crosslink Down      Init      *crosslink1  -             Blocking
1.0.14     Crosslink Down      Init      *crosslink2  -             Blocking
1.0.1      Downlink  Down      Init      -             -             Blocking
1.0.2      Downlink  Up        Full      Node2         5001          Forwarding
1.0.8      Downlink  Up        Full      downlink1     5001          Forwarding
* = Provisioned.
```

Table 51-1: Parameter in the output from **show atmf links brief**

Parameter	Definition
Local Port	Shows the local port on the selected node.
Link Type	Shows link type as Uplink or Downlink (parent and child) or Cross-link (nodes in same domain).
Link Status	Shows the link status of the local port on the node as either Up or Down.

Table 51-1: Parameter in the output from **show atmf links brief** (cont.)

Parameter	Definition
ATMF State	Shows AMF state of the local port: <ul style="list-style-type: none">• Init - Link is down.• Hold - Link transitioned to up state, but waiting for hold period to ensure link is stable.• Incompatible - Neighbor rejected the link because of inconsistency in AMF configurations.• OneWay - Link is up and has waited the hold down period and now attempting to link to another unit in another domain.• OneWaySim - Device is running in secure mode and link is up but waiting for authorization from an AMF master.• Full - Link hello packets are sent and received from its neighbor with its own node id.• Shutdown - Link has been shut down by user configuration.
Adjacent Node	Shows the Adjacent AMF Node to the one being configured.
Adjacent IF Index	Shows the IF index for the Adjacent AMF Node connected to the node being configured.
Link State	Shows the state of the AMF link. Valid states are either Forwarding or Blocking.

For information on filtering and saving command output, see the [“Getting Started with AlliedWare_Plus” Feature Overview and Configuration Guide](#).

Related commands

- [no debug all](#)
- [clear atmf links statistics](#)
- [show atmf](#)
- [show atmf links detail](#)
- [show atmf links guest](#)
- [show atmf links guest detail](#)
- [show atmf links statistics](#)
- [show atmf nodes](#)

show atmf links detail

Overview This command displays detailed information on all the links configured in the AMF network. It can only be run on AMF master and controller nodes.

Syntax `show atmf links detail`

Parameter	Description
detail	Detailed AMF links information.

Mode User Exec

Usage notes For summarized link information see the [show atmf links](#) command.
This command does not show links that are configured on provisioned ports.

Example To display the AMF link details use this command:

```
device1# show atmf links detail
```

The output from this command will display all the internal data held for AMF links. The following example gives details of the links that are summarized in the example in [show atmf links](#).

Table 52: Sample output from the **show atmf links detail** command

```
device1# show atmf links detail
-----
Crosslink Ports Information
-----
Port                : sa1
Ifindex             : 4501
Port Status         : Down
Port State          : Init
Last event          :
Port BPDU Receive Count : 0
Port                : po10
Ifindex             : 4610
Port Status         : Up
Port State          : Full
Last event          : AdjNodeLSEPresent
Port BPDU Receive Count : 140
Adjacent Node Name  : Building-B
Adjacent Ifindex    : 4610
Adjacent MAC        : eccd.6dd1.64d0
Port Last Message Response : 0
```

Table 52: Sample output from the **show atmf links detail** command (cont.)

```

Port : po30
Ifindex : 4630
Port Status : Up
Port State : Full
Last event : AdjNodeLSEPresent
Port BPDU Receive Count : 132
Adjacent Node Name : Building-A
Adjacent Ifindex : 4630
Adjacent MAC : eccd.6daa.c861
Port Last Message Response : 0

Link State Entries:

Crosslink Ports Blocking : False
Node.Ifindex : Building-A.4630 - Example-core.4630
Transaction ID : 2 - 2
MAC Address : eccd.6daa.c861 - 0000.cd37.054b
Link State : Full - Full

Node.Ifindex : Building-B.4610 - Example-core.4610
Transaction ID : 2 - 2
MAC Address : eccd.6ddl.64d0 - 0000.cd37.054b
Link State : Full - Full

Domain Nodes Tree:

Node : Building-A
  Links on Node : 1
  Link 0 : Building-A.4630 - Example-core.4630
  Forwarding State : Forwarding
Node : Building-B
  Links on Node : 1
  Link 0 : Building-B.4610 - Example-core.4610
  Forwarding State : Forwarding
Node : Example-core
  Links on Node : 2
  Link 0 : Building-A.4630 - Example-core.4630
  Forwarding State : Forwarding
  Link 1 : Building-B.4610 - Example-core.4610
  Forwarding State : Forwarding
Crosslink Transaction Entries:

Node : Building-B
Transaction ID : 2
Uplink Transaction ID : 6
Node : Building-A
Transaction ID : 2
Uplink Transaction ID : 6

Uplink Information:

Waiting for Sync : 0
Transaction ID : 6
Number of Links : 0
Number of Local Uplinks : 0
  
```

Table 52: Sample output from the **show atmf links detail** command (cont.)

```
Originating Node      : Building-A
Domain                : -'s domain
Node                  : Building-A
Ifindex               : 0
Node Depth            : 0
Transaction ID        : 6
Flags                 : 32
Domain Controller     : -
Domain Controller MAC : 0000.0000.0000

Originating Node      : Building-B
Domain                : -'s domain
Node                  : Building-B
Ifindex               : 0
Node Depth            : 0
Transaction ID        : 6
Flags                 : 32
Domain Controller     : -
Domain Controller MAC : 0000.0000.0000

Downlink Domain Information:

Domain                : Dept-A's domain
  Domain Controller    : Dept-A
  Domain Controller MAC : eccd.6d20.c1d9
  Number of Links      : 2
  Number of Links Up   : 2
  Number of Links on This Node : 2
  Links are Blocked    : 0
  Node Transaction List
    Node               : Building-B
    Transaction ID      : 8
    Node               : Building-A
    Transaction ID      : 8
  Domain List
    Domain              : Dept-A's domain
    Node                : Example-core
    Ifindex              : 4621
    Transaction ID      : 8
    Flags                : 1
    Domain              : Dept-A's domain
    Node                : Example-core
    Ifindex              : 4622
    Transaction ID      : 8
    Flags                : 1
```

Table 52: Sample output from the **show atmf links detail** command (cont.)

```

Domain : Dorm-D's domain
  Domain Controller : Dorm-D
  Domain Controller MAC : 0000.cd37.082c
  Number of Links : 2
  Number of Links Up : 2
  Number of Links on This Node : 2
  Links are Blocked : 0
  Node Transaction List
    Node : Building-B
    Transaction ID : 20
    Node : Building-A
    Transaction ID : 20
  Domain List
    Domain : Dorm-D's domain
    Node : Building-A
    Ifindex : 0
    Transaction ID : 20
    Flags : 32
    Domain : Dorm-D's domain
    Node : Building-B
    Ifindex : 0
    Transaction ID : 20
    Flags : 32
    Domain : Dorm-D's domain
    Node : Example-core
    Ifindex : 4510
    Transaction ID : 20
    Flags : 1
    Domain : Dorm-D's domain
    Node : Example-core
    Ifindex : 4520
    Transaction ID : 20
    Flags : 1

Domain : Example-edge's domain
  Domain Controller : Example-edge
  Domain Controller MAC : 001a.eb93.7aa6
  Number of Links : 1
  Number of Links Up : 1
  Number of Links on This Node : 0
  Links are Blocked : 0
  Node Transaction List
    Node : Building-B
    Transaction ID : 9
    Node : Building-A
    Transaction ID : 9
  
```

Table 52: Sample output from the **show atmf links detail** command (cont.)

```
Domain List
  Domain          : Example-edge's domain
  Node            : Building-A
  Ifindex         : 0
  Transaction ID  : 9
  Flags          : 32
  Domain          : Example-edge's domain
  Node            : Building-B
  Ifindex         : 5027
  Transaction ID  : 9
  Flags          : 1
-----
Up/Downlink Ports Information
-----
Port              : sa10
Ifindex           : 4510
Port Status       : Up
Port State        : Full
Last event        : LinkComplete
Adjacent Node     : Dorm-A
Adjacent Internal ID : 211
Adjacent Ifindex  : 4510
Adjacent Board ID : 387
Adjacent MAC      : eccd.6ddf.6cdf
Adjacent Domain Controller : Dorm-D
Adjacent Domain Controller MAC : 0000.cd37.082c
Port Forwarding State : Forwarding
Port BPDU Receive Count : 95
Port Sequence Number : 11
Port Adjacent Sequence Number : 7
Port Last Message Response : 0
Port              : po21
Ifindex           : 4621
Port Status       : Up
Port State        : Full
Last event        : LinkComplete
Adjacent Node     : Dept-A
Adjacent Internal ID : 29
Adjacent Ifindex  : 4621
Adjacent Board ID : 340
Adjacent MAC      : eccd.6d20.c1d9
Adjacent Domain Controller : Dept-A
Adjacent Domain Controller MAC : eccd.6d20.c1d9
Port Forwarding State : Forwarding
Port BPDU Receive Count : 96
Port Sequence Number : 8
Port Adjacent Sequence Number : 9
Port Last Message Response : 0
Special Link Present : FALSE
```

Table 53: Parameter definitions from the **show atmf links detail** command output

Parameter	Definition
Crosslink Ports Information	<p>Show details of all Crosslink ports on this Node:</p> <ul style="list-style-type: none"> • Port - Name of the Port or static aggregation (sa<*>). • Ifindex - Interface index for the crosslink port. • VR ID - Virtual router id for the crosslink port. • Port Status - Status of the local port on the Node as UP or DOWN. • Port State - AMF State of the local port. <ul style="list-style-type: none"> – Init - Link is down. – Hold - Link transitioned to up state, but waiting for hold period to ensure link is stable. – Incompatible - Neighbor rejected the link because of inconsistency in AMF configurations. – OneWay - Link is up and has waited the hold down period and now attempting to link to another unit in another domain – Full - Link hello packets are sent and received from its neighbor with its own node id. – Shutdown - Link has been shut down by user configuration. <p>Port BPDU Receive Count - The number of AMF protocol PDU's received.</p> <ul style="list-style-type: none"> • Adjacent Node Name - The name of the adjacent node connected to this node. • Adjacent Ifindex - Adjacent AMF Node connected to this Node. • Adjacent VR ID - Virtual router id of the adjacent node in the domain. • Adjacent MAC - MAC address of the adjacent node in the domain. • Port Last Message Response - Response from the remote neighbor to our AMF last hello packet.
Link State Entries	<p>Shows all the link state database entries:</p> <ul style="list-style-type: none"> • Node.Ifindex - Shows adjacent Node names and Interface index. • Transaction ID - Shows transaction id of the current crosslink transaction. • MAC Address - Shows adjacent Node MAC addresses. • Link State - Shows AMF states of adjacent nodes on the link.
Domain Nodes Tree	<p>Shows all the nodes in the domain:</p> <ul style="list-style-type: none"> • Node - Name of the node in the domain. • Links on Node - Number of crosslinks on a vertex/node. • Link no - Shows adjacent Node names and Interface index. • Forwarding State - Shows state of AMF link Forwarding/Blocking.
Crosslink Transaction Entries	<p>Shows all the transaction entries:</p> <ul style="list-style-type: none"> • Node - Name of the AMF node. • Transaction ID - transaction id of the node. • Uplink Transaction ID - transaction id of the remote node.

Table 53: Parameter definitions from the **show atmf links detail** command output (cont.)

Parameter	Definition
Uplink Information	<p>Show all uplink entries.</p> <ul style="list-style-type: none"> • Waiting for Sync - Flag if uplinks are currently waiting for synchronization. • Transaction ID - Shows transaction id of the local node. • Number of Links - Number of up downlinks in the domain. • Number of Local Uplinks - Number of uplinks on this node to the parent domain. • Originating Node - Node originating the uplink information. • Domain - Name of the parent uplink domain. • Node - Name of the node in the parent domain, that is connected to the current domain. • Ifindex - Interface index of the parent node's link to the current domain. • VR ID - Virtual router id of the parent node's link to the current domain. • Transaction ID - Transaction identifier for the neighbor in crosslink. • Flags - Used in domain messages to exchange the state: ATMF_DOMAIN_FLAG_DOWN = 0 ATMF_DOMAIN_FLAG_UP = 1 ATMF_DOMAIN_FLAG_BLOCK = 2 ATMF_DOMAIN_FLAG_NOT_PRESENT = 4 ATMF_DOMAIN_FLAG_NO_NODE = 8 ATMF_DOMAIN_FLAG_NOT_ACTIVE_PARENT = 16 ATMF_DOMAIN_FLAG_NOT_LINKS = 32 ATMF_DOMAIN_FLAG_NO_CONFIG = 64 • Domain Controller - Domain Controller in the uplink domain • Domain Controller MAC - MAC address of Domain Controller in uplink domain
Downlink Domain Information	<p>Shows all the downlink entries:</p> <ul style="list-style-type: none"> • Domain - Name of the downlink domain. • Domain Controller - Controller of the downlink domain. • Domain Controller MAC - MAC address of the domain controller. • Number of Links - Total number of links to this domain from the Node. • Number of Links Up - Total number of links that are in UP state. • Number of Links on This Node - Number of links terminating on this node. • Links are Blocked - 0 links are not blocked to the domain. 1 All links are blocked to the domain.

Table 53: Parameter definitions from the **show atmf links detail** command output (cont.)

Parameter	Definition
Node Transaction List	<p>List of transactions from this downlink domain node.</p> <ul style="list-style-type: none"> • Node - 0 links are not blocked to the domain. 1 All links are blocked to the domain. • Transaction ID - Transaction id for this node. • Domain List: Shows list of nodes in the current domain and their links to the downlink domain.: • Domain - Domain name of the downlink node. • Node - Name of the node in the current domain. • Ifindex - Interface index for the link from the node to the downlink domain. • Transaction ID - Transaction id of the node in the current domain. • Flags - As mentioned above.
Up/Downlink Ports Information	<p>Shows all the configured up and down link ports on this node:</p> <ul style="list-style-type: none"> • Port - Name of the local port. • Ifindex - Interface index of the local port. • VR ID - Virtual router id for the local port. • Port Status - Shows status of the local port on the Node as UP/DOWN. • Port State - AMF state of the local port. • Adjacent Node - nodename of the adjacent node. • Adjacent Internal ID - Unique node identifier of the remote node. • Adjacent Ifindex - Interface index for the port of adjacent AMF node. • Adjacent Board ID - Product identifier for the adjacent node. • Adjacent VR ID - Virtual router id for the port on adjacent AMF node. • Adjacent MAC - MAC address for the port on adjacent AMF node. • Adjacent Domain Controller - nodename of the Domain controller for Adjacent AMF node. • Adjacent Domain Controller MAC - MAC address of the Domain controller for Adjacent AMF node. • Port Forwarding State - Local port forwarding state Forwarding or Blocking. • Port BPDU Receive Count - count of AMF protocol PDU's received. • Port Sequence Number - hello sequence number, incremented every time the data in the hello packet changes. • Port Adjacent Sequence Number - remote ends sequence number used to check if we need to process this packet or just note it arrived. • Port Last Message Response - response from the remote neighbor to our last hello packet.

For information on filtering and saving command output, see the [“Getting Started with AlliedWare Plus” Feature Overview and Configuration Guide](#).

Related commands no debug all
clear atmf links statistics
show atmf

show atmf links guest

Overview This command displays information about guest nodes visible to an AMF device.

Syntax `show atmf links guest [interface <interface-range>]`

Parameter	Description
interface <interface-range>	Select a specific range of ports to display information about guest nodes.

Default With no parameters specified this command will display its standard output for all ports with guest nodes connected.

Mode User Exec/Privileged Exec

Usage notes Use this command to display the guest nodes connected to a single parent node. If you want to see a list of all the guests in the AMF network, use [show atmf guests](#).

Example 1 To display information about AMF guests that are connectible from node1, use the command:

```
node1# show atmf links guest
```

Output Figure 51-26: Example output from **show atmf links guest**

```
node1#sh atmf links guest

Guest Link Information:

DC = Discovery configuration
S = static D = dynamic

Local   Guest      Model      MAC      IP / IPv6
Port    Class      Type       DC Address Address
-----
1.0.1   -          other      D 0013.1a1e.4589 192.168.1.2
1.0.2   aastra-phone other      D 0008.5d10.7635 192.168.1.3
1.0.3   cisco-phone2 other      S -              192.168.2.1
1.0.4   panasonic... other      D 0800.239e.f1fe 192.168.1.5
```

Table 51-1: Parameters in the output from **show atmf links guest**

Parameter	Description
Local Port	The port on the parent node that connects to the guest.
Guest Class	The name of the ATMF guest-class that has been assigned to the guest node by the atmf guest-class command.

Table 51-1: Parameters in the output from **show atmf links guest** (cont.)

Parameter	Description
Model Type	The model type of the guest node, as entered by the <code>modeltype</code> command. Can be one of the following: <ul style="list-style-type: none">• alliedware• aw+• tq• other
DC	The discovery method as applied by the <code>discovery</code> command. This can be either dynamic (D) or static (S).
MAC Address	The MAC address of the guest node.
IP / IPv6 Address	The IP address of the guest node.

Related commands

- `atmf guest-class`
- `discovery`
- `http-enable`
- `username (atmf-guest)`
- `modeltype`
- `switchport atmf-guestlink`
- `show atmf backup guest`

show atmf links guest detail

Overview This command displays detailed information about guest nodes visible to an AMF device.

Syntax `show atmf links guest detail [interface <interface-range>]`

Parameter	Description
<code>interface</code> <code><interface-range></code>	Select a specific range of ports to display information about guest nodes.

Mode User Exec and Privileged Exec

Usage notes Use this command to display the guest nodes connected to a single parent node. If you want to see a list of all the guests in the AMF network, use [show atmf guests detail](#).

Note that the parameters that are displayed depend on the guest node's model and state.

Example To display detailed information about AMF guests, use the command:

```
node1# show atmf links guest detail
```

Output Figure 51-27: Example output from **show atmf links guest detail**

```

node1#show atmf links guest detail

Detailed Guest Link Information:

Interface           : port1.0.13
Link State          : Down
Class Name          : test
Model Type          : Other
Discovery Method    : Static
IP Address          : 192.168.1.13
Node State          : Down

Interface           : port1.0.5
Link State          : Full
Class Name          : tq_device
Model Type          : TQ
Discovery Method    : Dynamic
IP Address          : 192.168.1.221
Username            : manager
Login Fallback      : Yes
Node State          : Full
Backup Supported    : Yes
MAC address         : 001a.ebab.d2e0
Device Type         : AT-TQ4600
Description         : AP221
Firmware Version    : 3.2.1 B02
HTTP port           : 80
    
```

Table 51-2: Parameters in the output from **show atmf links guest detail**

Parameter	Description
Interface	The port on the parent node that connects to the guest.
Link State	The state of the link to the guest node; one of: <ul style="list-style-type: none"> Down: The physical link is down. Up: The physical link has come up, but it is still during a timeout period that is enforced to allow other links to come up. Learn: The timeout period described above has elapsed, and the link is now learning information from the AMF guest node. You can see what information it is learning from the "Node State" field below. Full: The node connected by this link has joined the AMF network. Fail: The port is physically up but something has prevented the guest node from joining the AMF network.
Class Name	The name of the ATMF guest-class that has been assigned to the guest node by the <code>atmf guest-class</code> command.

Table 51-2: Parameters in the output from **show atmf links guest detail** (cont.)

Parameter	Description
Model Type	The model type of the guest node, as entered by the <code>modeltype</code> command. The mode type can be one of the following: <ul style="list-style-type: none"> • alliedware • aw+ • onvif • tq • other
Discovery Method	The discovery method as applied by the <code>discovery</code> command. This can be either dynamic or static.
IP Address	The IP address of the guest node.
Username	The user name configured on the guest node.
Login Fallback	Whether the guest node supports Login Fallback. For TQ model guest nodes, when login fallback is enabled, if a guest node is replaced, then AMF logs in to the new TQ using the factory default manager/friend settings. The new TQ is then discovered and managed as an AMF guest node by an AMF master or member. This means any backed up settings for the replaced guest node can also be recovered.
Node state	The state of the guest node; one of: <ul style="list-style-type: none"> • Down: The initial state when a link to a guest node is first configured. This is also the state if the physical link goes down. • Getting IP: The AMF device is in the process of retrieving the IP address of the guest node. • Getting Mac: The AMF device is in the process of retrieving the MAC address of the guest node. • Getting Info: The AMF device is in the process of retrieving any other available information from the guest (firmware version etc). The information available depends on what device the guest node is. • Full: The AMF device has retrieved all necessary information and the guest node has joined the AMF network. Once this state is reached, the Link State also changes to "Full". • Failure: The physical link is up but the AMF member has failed to retrieve enough information to allow the guest node to join the AMF network.
Backup Supported	Whether the guest node supports AMF backup functionality.
MAC Address	The MAC address of the guest node.

Table 51-2: Parameters in the output from **show atmf links guest detail** (cont.)

Parameter	Description
Device Type	Model information for the guest node. This field shows the model information that AMF retrieved from the guest node. In contrast, the Model Type shows what a user entered as the type of device they intended this guest node to be.
Description	By default, this is a concatenation of the guest node's parent node and the port to which it is attached. You can change it by configuring a description on the port.
Serial Number	The serial number of the guest node.
Firmware Name	The name of the firmware operating on the guest node.
Firmware Version	The version of the firmware operating on the guest node.
HTTP port	The HTTP port as specified with the http-enable command when defining a guest class. You can set this if the guest node provides an HTTP user interface on a non-standard port (any port other than port 80).

Related commands

- [atmf guest-class](#)
- [discovery](#)
- [http-enable](#)
- [username \(atmf-guest\)](#)
- [modeltype](#)
- [switchport atmf-guestlink](#)
- [show atmf backup guest](#)

Command changes

Version 5.5.0-1.1: **Login Fallback** parameter added

show atmf links statistics

Overview This command displays details of the AMF links configured on the device and also displays statistics about the AMF packet exchanges between the devices.

It is also possible to display the AMF link configuration and packet exchange statistics for a specified interface.

This command can only be run on AMF master and controller nodes

Syntax `show atmf links statistics [interface [<port-number>]]`

Parameter	Description
interface	Specifies that the command applies to a specific interface (port) or range of ports. Where both the interface and port number are unspecified, full statistics (not just those relating to ports) will be displayed.
<port-number>	Enter the port number for which statistics are required. A port range, a static channel or LACP link can also be specified. Where no port number is specified, statistics will be displayed for all ports on the device.

Mode User Exec

Example 1 To display AMF link statistics for the whole device, use the command:

```
device1# show atmf links statistics
```

Table 52: Sample output from the **show atmf links statistics** command

ATMF Statistics:		
	Receive	Transmit
-----	-----	-----
Arealink Hello	318	327
Crosslink Hello	164	167
Crosslink Hello Domain	89	92
Crosslink Hello Uplink	86	88
Hello Link	0	0
Hello Neighbor	628	630
Hello Stack	0	0
Hello Gateway	1257	1257
Database Description	28	28
Database Request	8	6
Database Update	66	162
Database Update Bitmap	0	29
Database Acknowledge	144	51

Table 52: Sample output from the **show atmf links statistics** command (cont.)

```

Transmit Fails          0          1
Discards                0          0
Total ATMF Packets     2788      2837

ATMF Database Statistics:

Database Entries        18
Database Full Ages     0
ATMF Virtual Link Statistics:

Virtual                Receive          Receive          Transmit
link                  Receive          Dropped          Transmit          Dropped
-----
vlink2000             393              0                417              0

ATMF Packet Discards:
Type0  0      : Gateway hello msg received from unexpected neighbor
Type1  0      : Stack hello msg received from unexpected neighbor
Type2  0      : Discard TX update bitmap packet - bad checksum
Type3  0      : Discard TX update packet - neighbor not in correct state
Type4  0      : Discard update packet - bad checksum or type
Type5  0      : Discard update packet - neighbor not in correct state
Type6  0      : Discard update bitmap packet - bad checksum or type
Type7  0      : Incarnation is not possible with the data received
Type8  0      : Discard crosslink hello received - not correct state
Type9  0      : Discard crosslink domain hello received on non crosslink
Type10 0      : Discard crosslink domain hello - not in correct state
Type11 0      : Crosslink uplink hello received on non crosslink port
Type12 0      : Discard crosslink uplink hello - not in correct state
Type13 0      : Wrong network-name for this ATMF
Type14 0      : Packet received on port is too long
Type15 0      : Bad protocol version, received on port
Type16 0      : Bad packet checksum calculation
Type17 0      : Bad authentication type
Type18 0      : Bad simple password
Type19 0      : Unsupported authentication type
Type20 0      : Discard packet - unknown neighbor
Type21 0      : Discard packet - port is shutdown
Type22 0      : Non broadcast hello msg received from unexpected neighbor
Type23 0      : Arealink hello msg received on non arealink port
Type24 0      : Discard arealink hello packet - not in correct state
Type25 0      : Discard arealink hello packet - failed basic processing
Type26 0      : Discard unicast packet - MAC address does not match node
Type27 0      : AMF Master license node limit exceeded
    
```

Example 2 To display the AMF links statistics on interface port1.0.4, use the command:

```
device1# show atmf links statistics interface port1.0.4
```

Figure 51-28: Sample output from the **show atmf links statistics** command for interface port1.0.4

```

device1# show atmf links statistics interface port1.0.4

ATMF Port Statistics:

-----
port1.0.4  Crosslink Hello                231      232
port1.0.4  Crosslink Hello Domain           116      116
port1.0.4  Crosslink Hello Uplink           116      115
port1.0.4  Hello Link                        0         0
port1.0.4  Arealink Hello                   0         0
    
```

Figure 51-29: Parameter definitions from the **show atmf links statistics** command output

Parameter	Definition
Receive	Shows a count of AMF protocol packets received per message type.
Transmit	Shows the number of AMF protocol packets transmitted per message type.
Database Entries	Shows the number of AMF elements existing in the distributed database.
Database Full Ages	Shows the number of times the entries aged in the database.
ATMF Packet Discards	Shows the number of discarded packets of each type.

For information on filtering and saving command output, see the [“Getting Started with AlliedWare Plus” Feature Overview and Configuration Guide](#).

- Related commands**
- no debug all
 - clear atmf links statistics
 - show atmf

show atmf nodes

Overview This command displays nodes currently configured within the AMF network.

Note that the output also tells you whether or not node map exchange is active. Node map exchange improves the tracking of nodes joining and leaving an AMF network. This improves the efficiency of AMF networks. Node map exchange is only available if every node in your AMF network is running version 5.4.6-2.1 or later. We recommend running the latest version on all nodes in your network, so you receive the advantages of node map exchange and other improvements.

Syntax `show atmf nodes [guest|all]`

Parameter	Description
guest	Display only guest nodes in the AMF network.
all	Display all nodes in the AMF network, including guest nodes.

Mode Privileged Exec

Usage notes You can use this command to display one of three sets of nodes:

- all nodes except guest nodes, by specifying **show atmf nodes**
- all nodes including guest nodes, by specifying **show atmf nodes all**
- only guest nodes, by specifying **show atmf nodes guest**

Examples To display AMF information for all nodes except guest nodes, use the command:

```
node1# show atmf nodes
```

Table 51-1: Sample output from **show atmf nodes**

```
node1#show atmf nodes guest

Node Information:

* = Local device

SC = Switch Configuration:
C = Chassis   S = Stackable   N = Standalone

Node          Device          ATMF          Parent          Node
Name         Type            Master SC      Domain          Depth
-----
* M1          x510-28GTX      Y             S             none            0
N3           x230-18GP       N             N             M1              1
N1           AR4050S         N             N             M1              1

Node map exchange is active
Current ATMF node count 3
```

To display AMF information for all nodes, including guest nodes, use the command:

```
node1# show atmf nodes all
```

Table 52: Sample output from **show atmf nodes all**. In this example, not all nodes support node map exchange, as shown by the message at the end

```
node1#show atmf nodes all

Node and Guest Information:

* = Local device

SC = Switch Configuration:
C = Chassis   S = Stackable   N = Standalone G = Guest

Node/Guest      Device           ATMF           Parent         Node
Name            Type             Master  SC   Domain         Depth
-----
* M1             x510-28GTX      Y          S    none           0
N3              x230-18GP       N          N    M1             1
N1              AR4050S         N          N    M1             1
N3-1.0.24       AT-TQ4600       N          G    N3             -

Node map exchange is inactive
Firmware on some nodes does not support node map exchange, eg AR4050S
Current ATMF node count 4 (guests 1)
```

To display AMF information for guest nodes only, use the command:

```
node1# show atmf nodes guest
```

Table 51-1: Sample output from **show atmf nodes guest**

```
node1#show atmf nodes guest

Guest Information:
Device      MAC
Name        Address      Parent      Port      IP/IPv6
Address
-----
aastra-...  0008.5d10.7635 Node-1      1.0.2     192.168.4.7
poe-1.0.1   0013.1a1e.4589 Node-1      1.0.1     192.168.4.6
ip-camera   0800.239e.f1fe Node-1      1.0.4     192.168.4.8
tq4600      eccd.6df2.da60 Node-1      1.0.5     192.168.4.50
```

- Related commands**
- [show atmf](#)
 - [show atmf area nodes](#)
 - [discovery](#)
 - [http-enable](#)
 - [show atmf backup guest](#)

show atmf provision nodes

Overview This command displays information about each provisioned node with details about date and time of creation, boot and configuration files available in the backup, and license files present in the provisioned backup. This includes nodes that have joined the network but are yet to run their first backup.

This command can only be run on AMF master and controller nodes.

Syntax `show atmf provision nodes`

Mode Privileged Exec

Usage notes This command will only work if provisioned nodes have already been set up. Otherwise, an error message is shown when the command is run.

Example To show the details of all the provisioned nodes in the backup use the command:

```
NodeName# show atmf provision nodes
```

Figure 51-30: Sample output from the **show atmf provision nodes** command

```
device1#show atmf provision nodes

ATMF Provisioned Node Information:

Backup Media .....: SD (Total 3827.0MB, Free 3481.1MB)

Node Name           : device2
Date& Time          : 06-Oct-2016 & 23:25:44
Provision Path      : card:/atmf/provision_nodes

Boot configuration :
Current boot image  : x510-5.4.9-0.1.rel (file exists)
Backup boot image   : x510-5.4.8-2.3.rel (file exists)
Default boot config : flash:/default.cfg (file exists)
Current boot config : flash:/abc.cfg (file exists)
Backup boot config  : flash:/xyz.cfg (file exists)

Software Licenses :
Repository file     : ../configs/.sw_v2.lic
                   : ../configs/.swfeature.lic
Certificate file    : card:/atmf/nodes/awplus1/flash/.atmf-lic-cert
```

- Related commands**
- [atmf provision \(interface\)](#)
 - [atmf provision node](#)
 - [clone \(amf-provision\)](#)
 - [configure boot config \(amf-provision\)](#)
 - [configure boot system \(amf-provision\)](#)
 - [create \(amf-provision\)](#)

delete (amf-provision)
identity (amf-provision)
license-cert (amf-provision)
locate (amf-provision)

show atmf recovery-file

Overview Use this command to display the recovery file information for an AMF node. AMF recovery files are created for nodes with special links. Special links include:

- virtual links,
- area links terminating on an AMF master, and
- area virtual links terminating on an AMF master.

Syntax `show atmf recovery-file`

Mode Privileged Exec

Example To display recovery file information for an AMF node, use the command:

```
node1# show atmf recovery-file
```

Output Figure 51-31: Example output from **show atmf recovery-file**

```
node1#show atmf recovery-file

ATMF Recovery File Info: Special Link Present
Location                               Date           Time
USB storage device                     30 Apr 2018   14:50:32
Master                                  30 Apr 2018   14:56:45
node1                                   30 Apr 2018   14:56:45
node3                                   30 Apr 2018   14:56:45
```

Related commands [clear atmf recovery-file](#)
[show atmf backup](#)

Command changes Version 5.4.8-0.2: command added

show atmf secure-mode

Overview Use this command to display an overview of the secure mode status of an AMF network.

Syntax show atmf secure-mode

Mode Privileged Exec

Example To display an overview of AMF secure mode on an AMF master or member node, use the command:

```
awplus# show atmf secure-mode
```

Output Figure 51-32: Example output from **show atmf secure-mode** on an AMF master

```
ATMF Secure Mode:

Secure Mode Status           : Enabled
Certificate Expiry           : 180 Days
Certificates Total            : 8
Certificates Revoked          : 0
Certificates Rejected         : 0
Certificates Active           : 8

Provisional Authorization    : 0
Pending Requests             : 0

Trusted Master                : master_1
Trusted Master                : master_2

Key Fingerprint:
 48:37:d9:a0:37:32:22:9b:5c:22:da:a2:62:49:a7:e5:a9:bc:12:88
```

Figure 51-33: Example output from **show atmf secure-mode** on an AMF node

```
ATMF Secure Mode:

Secure Mode Status           : Enabled
Trusted Master                : master_1
Trusted Master                : master_2

Key Fingerprint:
 93:f0:52:a9:74:8f:ae:ea:5b:e2:ee:62:cb:6b:21:22:5a:08:db:98
```

Table 51-2: Parameters in the output from **show atmf secure-mode**

Parameter	Description
Secure Mode Status	Shows the status of secure mode, Enabled or Disabled.
Certificate Expiry	Certificate expiry time. Set with atmf secure-mode certificate expiry
Certificates Total	Total number of certificates.
Certificates Revoked	Certificates that have been revoked by the AMF master.
Certificates Rejected	Certificates that have been rejected by the AMF master.
Certificates Active	Certificates that are currently active.
Provisional Authorization	Number of nodes with provisional authorization. For more information use the show atmf authorization provisional command.
Pending Requests	Number of nodes waiting for authorization on the AMF master. For more information use the show atmf authorization pending command.
Trusted Master	List of trusted masters in the AMF area.
Key Fingerprint	The AMF node's key fingerprint.

Related commands

- [atmf authorize](#)
- [atmf secure-mode](#)
- [atmf secure-mode certificate expiry](#)
- [show atmf authorization](#)
- [show atmf secure-mode audit link](#)

Command changes

- Version 5.4.7-0.3: command added

show atmf secure-mode audit

Overview Use this command to detect security vulnerabilities on a node.

Syntax show atmf secure-mode audit

Mode Privileged Exec

Example To display AMF secure mode link audits for a node, use the command
awplus# show atmf secure-mode audit

Output Figure 51-34: Example output from **show atmf secure-mode audit**

```
ATMF Secure Mode Audit:

Warning   : The default username and password is enabled.
Good      : SNMP V1 or V2 is disabled.
Warning   : Telnet server is enabled.
Good      : ATMF is enabled. Secure-Mode is on.
Good      : ATMF Topology-GUI is disabled. No trustpoints configured.

ATMF Secure Mode Log Events:

-----
2017 Feb 2 00:59:25 user.notice node1 ATMF[848]: Sec_Audit - ATMF Secure
Mode is enabled.
2017 Feb 2 01:30:00 user.notice node1 ATMF[848]: Sec_Audit - Established
secure connection to area_1_node_1 on interface vlink1.
```

Table 51-3: Parameters in the output from **show atmf secure-mode audit link**

Parameter	Description
ATMF Secure Mode Audit	A list of security recommendations to secure the AMF network. Items prefaced with <code>Warning</code> need to be fixed. In the sample above the default username and password, and telnet, should be disabled.
ATMF Secure Mode Log Events	A list of recorded secure mode log events.

Related commands [show atmf secure-mode](#)

Command changes Version 5.4.7-0.3: command added

show atmf secure-mode audit link

Overview Use this command to detect security vulnerabilities by identifying devices that are connected to a secure mode node that are not in secure mode or are not authorized.

Syntax `show atmf secure-mode audit link`

Mode Privileged Exec

Example To display AMF secure mode link audits for a node, use the command
`awplus# show atmf secure-mode audit link`

Output Figure 51-35: Example output from **show atmf secure-mode audit link**

```
ATMF Secure Mode Audit Link:

* ATMF links connected to devices which are not authorized
  or are not in secure-mode.

Port          Link Type   Discovered          Node/Area Name
-----
vlink1       Downlink   16/02/2017 09:28:22 Member3
```

Table 51-4: Parameters in the output from **show atmf secure-mode audit link**

Parameter	Description
Port	Port name on local device.
Link Type	Link type.
Discovered	Date discovered
Node/Area Name	Node or area name of remote device.

Related commands [show atmf](#)
[show atmf secure-mode](#)

Command changes Version 5.4.7-0.3: command added

show atmf secure-mode certificates

Overview Use this command to display the certificate status details when secure mode is enabled on an AMF network.

Syntax `show atmf secure-mode certificates [detail] [area <area-name>]
[node <node-name>]`

Parameter	Description
detail	Display detailed certificate information.
area	Specify an AMF area.
<area-name>	The AMF area you want to see the certificate information for.
node	Specify an AMF node.
<node-name>	The AMF node you want to see information for.

Mode Privileged Exec

Example To display AMF secure mode certificates on a master or member node, use the command:

```
awplus# show atmf secure-mode certificates
```

To display detailed information about AMF secure mode certificates for a node named "area_2_node_1" in an area named "area-2", use the command:

```
awplus# show atmf secure-mode certificates detail area area-2  
node area_2_node_1
```

Output Figure 51-36: Example output from **show atmf secure-mode certificates**

```
Area-1 Certificates:
Node Name          Signer             Expires            Status
-----
area_1_node_1     master_1           11 Mar 2017
                  master_2           4 Mar 2017        Active
area_1_node_2     master_1           11 Mar 2017
                  master_2           4 Mar 2017        Revoked

Area-2 Certificates:
Node Name          Signer             Expires            Status
-----
area_2_node_1     master_1           18 Mar 2017        Active
area_2_node_2     master_1           18 Mar 2017        Rejected
```

Table 51-5: Parameters in the output from **show atmf secure-mode certificates**

Parameter	Description
Node Name	Name of AMF node the certificate was issued to.
Signer	Name of AMF master that issued the certificate.
Expires	Certificate expiry date.
Status	The status column will display <i>Active</i> before a member node is trusted, and can be accessed using AMF commands. Valid statuses are <i>Active</i> , <i>Revoked</i> , and <i>Rejected</i> .

Output Figure 51-37: Example output from **show atmf secure-mode certificates detail area area-2 node area_2_node_1**

```
Certificates Detail:
-----
area_2_node_1 (area:area-2)
  MAC Address      : 0000.cd37.0003
  Status           : Active
  Serial Number    : A24SC8001
  Product          : x510-28GTX
  Key Fingerprint  : cd:b4:c9:cd:7b:87:6a:30:98:25:d7:3c:89:8e:cb:74:e8:91:56:9d
  Flags            : 00000011
  Signer           : master_1
  Expiry Date      : 18 Mar 2017 21:17:42
```

Table 51-6: Parameters in the output from **show atmf secure-mode certificates detail**

Parameter	Description
MAC Address	MAC address of AMF node.
Status	The device status will show <i>Active</i> if a member node is trusted, and can be accessed using AMF commands. Valid statuses are <i>Active</i> , <i>Revoked</i> , and <i>Rejected</i> .
Serial Number	Device serial number.
Product	Device product type.
Key Fingerprint	AMF node key fingerprint.
Flags	Internal AMF information.
Signer	Name of AMF master that issued the certificate.
Expiry Date	Certificate expiry date.

Related commands

- atmf authorize
- atmf secure-mode
- atmf secure-mode certificate expire
- atmf secure-mode certificate renew
- clear atmf secure-mode certificates
- show atmf secure-mode sa

Command changes Version 5.4.7-0.3: command added

show atmf secure-mode sa

Overview Use this command to display the security associations on the network. This is the list of links and neighbors that are trusted.

Syntax `show atmf secure-mode sa [detail] [link|neighbor|broadcast]`

Parameter	Description
detail	Display detailed security association information.
link	Display security associations for type links.
neighbor	Display security associations for type neighbors.
broadcast	Display security associations for type broadcast.

Mode Privileged Exec

Example To display an overview of AMF secure mode security associations on a master or member node, use the command:

```
awplus# show atmf secure-mode sa
```

To display a detailed overview of AMF secure mode neighbor security associations on a master or member node, use the command:

```
awplus# show atmf secure-mode sa detail neighbor
```

Output Figure 51-38: Example output from **show atmf secure-mode sa**

```
ATMF Security Associations:
```

Type	State	ID	Details
Neighbor Node	Complete	175	master_1
Broadcast	Complete	4095	
CrossLink	Complete	4501	sa1
AreaLink	Cert Exchg	4511	sa11
Link	Complete	6009	port1.2.9
AreaLink	CA Exchg Init	6013	port1.2.13
AreaLink	Cert Exchg	13001	port1.9.1
Link	CA Exchg Init	16779521	vlink3
Neighbor Gateway	Complete	83	master_2
Neighbor Gateway	Complete	175	master_1
Neighbor Cntl-Master	Complete	83	master_2
Neighbor Cntl-Master	Complete	175	master_1

Figure 51-39: Example output from **show atmf secure-mode sa detail neighbor**

```
Security Associations Detail:
-----
Id           : 175 (af)
  Type      : Neighbor Node
  State     : Complete
  Remote MAC Address : eccd.6d82.6c16
  Flags     : 000003c0

Id           : 83 (40000053)
  Type      : Neighbor Gateway
  State     : Complete
  Remote MAC Address : 001a.eb54.e53b
  Flags     : 000003c0

Id           : 175 (400000af)
  Type      : Neighbor Gateway
  State     : Complete
  Remote MAC Address : eccd.6d82.6c16
  Flags     : 000003c0

Id           : 83 (80000053)
  Type      : Neighbor Cntl-Master
  State     : Complete
  Remote MAC Address : 001a.eb54.e53b
  Flags     : 000003c0

Id           : 175 (800000af)
  Type      : Neighbor Cntl-Master
  State     : Complete
  Remote MAC Address : eccd.6d82.6c16
  Flags     : 000003c0

Id           : 321 (80000141)
  Type      : Neighbor Cntl-Master
  State     : Complete
  Remote MAC Address : 0000.f427.93da
  Flags     : 000003c0
```

Table 51-7: Parameters in the output from **show atmf secure-mode sa**

Parameter	Description
Type	Security Association (SA) types: <ul style="list-style-type: none"> • Link - SA for link • CrossLink - SA for crosslink • AreaLink - SA for area link • Neighbor Node - SA for node neighbor relationship • Neighbor Gateway - SA for gateway neighbor relationship • Neighbor Cntl-Master - SA for controller/master neighbor relationship • Broadcast - SA for working-set broadcast requests
State	Current state of the Security Association. The state must be <code>Complete</code> before a member node is trusted, and can be accessed using AMF commands. <ul style="list-style-type: none"> • CA Exchg Init - SA is ready to begin the SA exchange process • CA Exchg - SA is currently exchanging CAs • Cert Exchg - SA is currently exchanging certificates • Key Exchg - SA is currently exchanging ephemeral keys • Complete - SA exchange has completed
ID	Security Association ID. <ul style="list-style-type: none"> • For Neighbor types this is the remote node ID. • For Link types this is the local ifindex. • For Broadcast type this is always 4095.
Details	Human readable translation of ID. <ul style="list-style-type: none"> • For Neighbor types this is the node name • For Link types this is the interface name
Remote MAC Address	MAC address of the remote partner of the security association.
Flags	Internal AMF information.

Related commands

- [atmf secure-mode](#)
- [show atmf secure-mode](#)
- [show atmf secure-mode certificates](#)

Command changes

Version 5.4.7-0.3: command added

show atmf secure-mode statistics

Overview Use this command to display AMF secure mode statistics. These statistics are from when AMF secure mode was first enabled or the statistics were cleared with the `clear atmf secure-mode statistics` command.

Syntax `show atmf secure-mode statistics`

Mode Privileged Exec

Example To display AMF secure mode statistics on a master or member node, use the command:

```
awplus# show atmf secure-mode statistics
```

Output Figure 51-40: Example output from `show atmf secure-mode statistics` on an AMF master.

```
ATMF Secure Mode Statistics:

Certificates:
New ..... 7                Expired ..... 0
Updated ..... 7            Deleted ..... 0
Revoked ..... 1            Renewed ..... 2
Rejected ..... 1           Re-authorized .... 1
Authorized ..... 0

Local Certificates:
Valid ..... 4                Invalid ..... 0
Certificates Validation:
Request Valid ..... 2
Request Invalid ..... 0
Common Valid ..... 13
Common Invalid ..... 0
Issuer Valid ..... 14
Issuer Invalid ..... 0
Signature Verified ..... 29
Signature Invalid ..... 0
Signature Purpose Invalid ..... 0

Signatures Signed ..... 12
Master Certificates:
Re-issued ..... 3
Downgraded to member ..... 0

Public key change ..... 2
Invalid SA public key ..... 0
```

Output Figure 51-41: Example output from **show atmf secure-mode statistics** on an AMF node.

```
ATMF Secure Mode Statistics:

Local Certificates:
Valid ..... 3          Invalid ..... 0

Certificates Validation:
Request Valid ..... 0
Request Invalid ..... 0
Common Valid ..... 0
Common Invalid ..... 0
Issuer Valid ..... 12
Issuer Invalid ..... 0
Signature Verified ..... 12
Signature Invalid ..... 3
Signature Purpose Invalid ..... 0

Signatures Signed ..... 0

Master Certificates:
Re-issued ..... 0
Downgraded to member ..... 0

Public key change ..... 2
Invalid SA public key ..... 0
```

- Related commands**
- [atmf authorize](#)
 - [atmf secure-mode](#)
 - [atmf secure-mode certificate renew](#)
 - [clear atmf secure-mode statistics](#)
 - [show atmf secure-mode](#)

Command changes Version 5.4.7-0.3: command added

show atmf tech

Overview This command collects and displays all the AMF command output. The command can thus be used to display a complete picture of an AMF network.

Syntax show atmf tech

Mode Privileged Exec

Example To display output for all AMF commands, use the command:

```
NodeName# show atmf tech
```

Table 52: Sample output from the **show atmf tech** command.

```
node1#show atmf tech
ATMF Summary Information:

ATMF Status           : Enabled
Network Name          : ATMF_NET
Node Name              : node1
Role                   : Master
Current ATMF Nodes    : 8

ATMF Technical information:

Network Name           : ATMF_NET
Domain                 : node1's domain
Node Depth             : 0
Domain Flags           : 0
Authentication Type    : 0
MAC Address            : 0014.2299.137d
Board ID               : 287
Domain State           : DomainController
Domain Controller      : node1
Backup Domain Controller : node2
Domain controller MAC  : 0014.2299.137d
Parent Domain          : -
Parent Domain Controller : -
Parent Domain Controller MAC : 0000.0000.0000
Number of Domain Events : 0
Crosslink Ports Blocking : 0
Uplink Ports Waiting on Sync : 0
```

Table 52: Sample output from the **show atmf tech** command. (cont.)

Crosslink Sequence Number	: 7
Domains Sequence Number	: 28
Uplink Sequence Number	: 2
Number of Crosslink Ports	: 1
Number of Domain Nodes	: 2
Number of Neighbors	: 5
Number of Non Broadcast Neighbors	: 3
Number of Link State Entries	: 1
Number of Up Uplinks	: 0
Number of Up Uplinks on This Node	: 0
DBE Checksum	: 84fc6
Number of DBE Entries	: 0
...	

Table 53: Parameter definitions from the **show atmf tech** command

Parameter	Definition
ATMF Status	Shows status of AMF feature on the Node as Enabled/Disabled.
Network Name	The name of the AMF network to which this node belongs.
Node Name	The name assigned to the node within the AMF network.
Role	The role configured on the device within the AMF - either master or member.
Current ATMF Nodes	A count of the AMF nodes in the AMF network.
Node Address	The identity of a node (in the format name.atmf) that enables its access it from a remote location.
Node ID	A unique identifier assigned to an AMF node.
Node Depth	The number of nodes in the path from this node to the core domain.
Domain State	A node's state within an AMF Domain - either controller or backup.
Recovery State	The AMF node recovery status. Indicates whether a node recovery is in progress on this device - either Auto, Manual, or None.
Management VLAN	The VLAN created for traffic between nodes of different domains (up/down links). VLAN ID - In this example VLAN 4092 is configured as the Management VLAN. Management Subnet - the Network prefix for the subnet. Management IP Address - the IP address allocated for this traffic. Management Mask - the Netmask used to create a subnet for this traffic 255.255.128.0 (= prefix /17)

Table 53: Parameter definitions from the **show atmf tech** command (cont.)

Parameter	Definition
Domain VLAN	The VLAN assigned for traffic between Nodes of same domain (crosslink). VLAN ID - In this example VLAN 4091 is configured as the domain VLAN. Domain Subnet - the Subnet address used for this traffic. Domain IP Address - the IP address allocated for this traffic. Domain Mask - the Netmask used to create a subnet for this traffic 255.255.128.0 (= prefix /17)
Device Type	Shows the Product Series Name.
ATMF Master	Indicates the node's membership of the core domain (membership is indicated by Y)
SC	Shows switch configuration: <ul style="list-style-type: none">• C - Chassis (such as SBx8100 series)• S - Stackable (VCS)• N - Standalone
Parent	A node that is connected to the present node's uplink, i.e. one layer higher in the hierarchy.
Node Depth	Shows the number of nodes in path from the current node to the Core domain.

NOTE: The **show atmf tech** command can produce very large output. For this reason only the most significant terms are defined in this table.

show atmf virtual-links

Overview This command displays a summary of all virtual links (L2TP tunnels) currently in the running configuration.

Syntax `show atmf virtual-links [macaddr]`
`show atmf virtual-links [id <1-4094>] [remote-id <1-4094>]`
`show atmf virtual-links detail [id <1-4094>]`

Parameter	Description
macaddr	Display the virtual AMF links' MAC addresses.
id <1-4094>	ID of the local virtual link.
remote-id <1-4094>	ID of the remote virtual link
detail	Display information about a specific virtual link ID or range of virtual link IDs. Displays information such as: local and remote IP address, link type, packets received and transmitted.

Mode Privileged Exec

Example 1 To display AMF virtual links, use the command:

```
node_1# show atmf virtual-links
```

Table 51-1: Example output from **show atmf virtual-links**

```
ATMF Virtual-Link Information:
-----
Local      Local      Remote      Tunnel      Tunnel
Port      ID   IP          ID   IP          Protect     State
-----
vlink1    1     172.16.24.2  2     1.0.0.2     -           Complete
vlink2    2     172.16.24.2* 10    172.16.24.3* ipsec       Complete
vlink3    3     (eth0)*      1     1.2.3.4     -           AcquireLocal

* = Dynamic Address.

Virtual Links Configured: 3
```

In the above example, a centrally located switch has the IP address space 192.0.2.x/24. It has two VLANs assigned the subnets 192.0.2.33 and 192.0.2.65 using the prefix /27. Each subnet connects to a virtual link. The first link has the IP address 192.168.1.1 and has a Local ID of 1. The second has the IP address 192.168.2.1 and has the Local ID of 2.

Example 2 To display details about AMF virtual link with ID 1, use the command:

```
node_1# show atmf virtual-links detail id 1
```

Table 51-2: Example output from **show atmf virtual-links**

```

Virtual Link Detailed Information:

ID 1      Description      : None
ID 1      Local IP Address  : 192.168.5.1
ID 1      Remote ID        : 1
ID 1      Remote IP Address  : 192.168.5.20
ID 1      Link Type        : virtual-link
ID 1      Packets Received  : 236465
ID 1      Packets Transmitted : 192626
    
```

Example 3 To display AMF virtual links’ MAC address information, use the command:

```
node_1# show atmf virtual-links macaddr
```

Table 51-3: Example output from **show atmf virtual-links macaddr**

```

ATMF Link Remote Information:

ATMF Management Bridge Information:

Bridge: br-atmfmgmt

port no mac addr          is local?    ageing timer
  1    00:00:cd:27:c2:07    yes          0.00
  2    8e:c7:ae:81:7e:68    yes          0.00
  2    00:00:cd:28:bf:e7    no           0.01
    
```

Table 51-4: Parameters in the output from **show atmf virtual-links**

Parameter	Definition
Local Port	The tunnel name e.g. vlink1, vlink2, equivalent to an L2TP tunnel.
Local ID	The local ID of the virtual link. This matches the vlink<number>
Tunnel Protect	Tunnel protection protocol.
Tunnel State	The operational state of the vlink (either Up or Down). This state is always displayed once a vlink has been created.
mac addr	AMF virtual links terminate on an internal soft bridge. The “show atmf virtual-links macaddress” command displays MAC Address information.
is local?	Indicates whether the MAC displayed is for a local or a remote device.
ageing timer	Indicates the current aging state for each MAC address.

Related commands [atmf virtual-link](#)

show atmf working-set

Overview This command displays the nodes that form the current AMF working-set.

Syntax `show atmf working-set`

Mode Privileged Exec

Example To show current members of the working-set, use the command:

```
ATMF_NETWORK[6]# show atmf working-set
```

Table 52: Sample output from the **show atmf working-set** command.

```
ATMF Working Set Nodes:  
  
node1, node2, node3, node4, node5, node6  
  
Working set contains 6 nodes
```

Related commands

- [atmf working-set](#)
- [show atmf](#)
- [show atmf group](#)

show debugging atmf

Overview Use this command to see what debugging is turned on for AMF.
For information on filtering and saving command output, see the [“Getting Started with AlliedWare Plus” Feature Overview and Configuration Guide](#).

Syntax `show debugging atmf`

Mode Privileged Exec

Example To display the AMF debugging status, use the command:

```
node_1# show debugging atmf
```

Table 51-1: Sample output from the **show debugging atmf** command.

```
node_1# show debugging atmf
ATMF debugging status:
ATMF arealink debugging is on
ATMF link debugging is on
ATMF crosslink debugging is on
ATMF database debugging is on
ATMF neighbor debugging is on
ATMF packet debugging is on
ATMF error debugging is on
```

Related commands [debug atmf packet](#)

show debugging atmf packet

Overview Use this command to see what debugging is turned on for AMF Packet debug. For information on filtering and saving command output, see the [“Getting Started with AlliedWare Plus” Feature Overview and Configuration Guide](#).

Syntax `show debugging atmf packet`

Mode User Exec and Privileged Exec

Example To display the AMF packet debugging status, use the command:

```
node_1# show debug atmf packet
```

Table 51-2: Sample output from the **show debugging atmf packet** command.

```
ATMF packet debugging is on
=== ATMF Packet Debugging Parameters===
Node Name: x908
Port name: port1.1.1
Limit: 500 packets
Direction: TX
Info Level: Level 2
Packet Type Bitmap:
2. Crosslink Hello BPDU pkt with downlink domain info
3. Crosslink Hello BPDU pkt with uplink info
4. Down and up link Hello BPDU pkts
6. Stack hello unicast pkts
8. DBE request
9. DBE update
10. DBE bitmap update
```

Related commands [debug atmf](#)
[debug atmf packet](#)

show running-config atmf

Overview This command displays the running system information that is specific to AMF.

Syntax `show running-config atmf`

Mode User Exec and Global Configuration

Example To display the current configuration of AMF, use the following commands:

```
node_1# show running-config atmf
```

For information on filtering and saving command output, see the [“Getting Started with AlliedWare Plus” Feature Overview and Configuration Guide](#).

Related commands `show running-config`
`no debug all`

state

Overview This command sets the running state of an AMF container on a Virtual AMF Appliance (VAA).

An AMF container is an isolated instance of AlliedWare Plus with its own network interfaces, configuration, and file system. The features available inside an AMF container are a sub-set of the features available on the host VAA. These features enable the AMF container to function as a uniquely identifiable AMF master and allows for multiple tenants (up to 60) to run on a single VAA host. See the [AMF Feature Overview and Configuration Guide](#) for more information on running multiple tenants on a single VAA host.

Syntax `state {enable|disable}`

Parameter	Description
disable	Stop the AMF container. The container's state changes to stopped.
enable	Start the AMF container. The container's state changes to running.

Default By default, **state** is disabled.

Mode AMF Container Configuration

Usage notes The first time the **state enable** command is executed on a container it assigns the container to an area and configures it as an AMF master. This is achieved by automatically adding the following configuration to the AMF container:

```
atmf network-name <AMF network-name>
atmf master
atmf area <container area-name> <container area-id> local
atmf area <container area-name> password <container area-password>
atmf area <host area-name> <host area-id>

interface eth0
  atmf-arealink remote-area <host area-name> vlan 4094
```

For this reason the **state enable** command should be run after the container has been created with the [atmf container](#) command and an area-link configured with the [area-link](#) command.

Once the start-up configuration has been saved from within the AMF container, all further configuration changes need to be made manually.

Example To start the AMF container “vac-wlg-1” use the commands:

```
awplus# configure terminal
awplus(config)# atmf container vac-wlg-1
awplus(config-atmf-container)# state enable
```

To stop the AMF container “vac-wlg-1” use the commands:

```
awplus# configure terminal
awplus(config)# atmf container vac-wlg-1
awplus(config-atmf-container)# state disable
```

Related commands [atmf container](#)
[show atmf container](#)

Command changes Version 5.4.7-0.1: command added

switchport atmf-agentlink

Overview Use this command to configure a link between this device and an x600 Series switch, in order to integrate the x600 Series switch into your AMF network. The x600 Series switch is called an “AMF agent”, and the link between the x600 and this device is called an “agent link”.

The x600 Series switch must be running version 5.4.2-3.16 or later.

Use the **no** variant of this command to remove the agent link. If the x600 Series switch is still connected to the switch port, it will no longer be part of the AMF network.

Syntax `switchport atmf-agentlink`
`no switchport atmf-agentlink`

Default By default, no agent links exist and x600 Series switches are not visible to AMF networks.

Mode Interface mode for a switch port. Note that the link between the x600 and the AMF network must be a single link, not an aggregated link.

Usage notes The x600 Series switch provides the following information to the AMF node that it is connected to:

- The MAC address
- The IPv4 address
- The IPv6 address
- The name/type of the device (Allied Telesis x600)
- The name of the current firmware
- The version of the current firmware
- The configuration name

AMF guestnode also makes most of this information available from x600 Series switches, but requires configuration with DHCP and/or LLDP. AMF agent is simpler; as soon the x600 is connected to an appropriately configured port of an AMF node, it is immediately integrated into the AMF network.

To see information about the x600 Series switch, use the **show atmf links guest detail** command.

Example To configure port1.0.1 as an agent link, use the commands:

```
awplus# configure terminal
awplus(config)# interface port1.0.1
awplus(config-if)# switchport atmf-agentlink
```

Related commands [show atmf links guest](#)

switchport atmf-arealink

Overview This command enables you to configure a port or aggregator to be an AMF area link. AMF area links are designed to operate between two nodes in different areas in an AMF network.

Use the **no** variant of this command to remove any AMF area link that may exist for the selected port or aggregated link.

This command is only available on AMF controllers and master nodes.

Syntax `switchport atmf-arealink remote-area <area-name> vlan <2-4094>`
`no switchport atmf-arealink`

Parameter	Description
<area-name>	The name of the remote area that the port is connecting to.
<2-4094>	The VLAN ID for the link. This VLAN cannot be used for any other purpose, and the same VLAN ID must be used at each end of the link.

Default No arealinks are configured.

Mode Interface Configuration for a switchport, a static aggregator, or a dynamic channel group.

Usage notes Run this command on the port or aggregator at both ends of the link.

Each area must have the area-name configured, and the same area password must exist on both ends of the link.

Running this command will automatically place the port or static aggregator into trunk mode (i.e. switchport mode trunk) and will synchronize the area information stored on the two nodes.

You can configure multiple arealinks between two area nodes, but only one arealink at any time will be in use. All other arealinks will block information, to prevent network storms.

NOTE: See the [atmf-arealink](#) command to configure an AMF area link on an AR-series Eth interface.

Example To make switchport port1.0.2 an arealink to the 'Auckland' area on VLAN 6, use the commands:

```
controller-1# configure terminal
controller-1(config)# interface port1.0.2
controller-1(config-if)# switchport atmf-arealink remote-area
Auckland vlan 6
```

To remove switchport port1.0.1 as an AMF area link, use the commands:

```
controller-1# configure terminal
controller-1(config)# interface port1.0.1
controller-1(config-if)# no switchport atmf-arealink
```

**Related
commands**

[atmf area](#)
[atmf area password](#)
[atmf virtual-link](#)
[show atmf links](#)

switchport atmf-crosslink

Overview This command configures the selected port, statically aggregated link or dynamic channel group (LACP) to be an AMF crosslink. Running this command will automatically place the port or aggregator into trunk mode (i.e. **switchport mode trunk**).

The connection between two AMF masters must utilize a crosslink. Crosslinks are used to carry the AMF control information between master nodes. Multiple crosslinks can be configured between two master nodes, but only one crosslink can be active at any particular time. All other crosslinks between masters will be placed in the blocking state, in order to prevent broadcast storms.

Note that AlliedWare Plus CentreCOM Series switches are AMF Edge nodes and do not support virtual links or crosslinks. This is because each edge node can only have a single physical AMF link.

Use the **no** variant of this command to remove any crosslink that may exist for the selected port or aggregated link.

Syntax `switchport atmf-crosslink`
`no switchport atmf-crosslink`

Mode Interface Configuration for a switchport, a static aggregator or a dynamic channel group.

Usage notes Crosslinks can be used anywhere within an AMF network. They have the effect of separating the AMF network into separate domains.

Where this command is used, it is also good practice to use the **switchport trunk native vlan** command with the parameter **none** selected. This is to prevent a network storm on a topology of ring connected devices.

Example 1 To make switchport port1.0.1 an AMF crosslink, use the following commands:

```
Node_1# configure terminal
Node_1(config)# interface port1.0.1
Node_1(config-if)# switchport atmf-crosslink
```

Example 2 This example is shown twice. Example 2A is the most basic command sequence. Example 2B is a good practice equivalent that avoids problems such as broadcast storms that can otherwise occur.

Example 2A To make static aggregator sa1 an AMF crosslink, use the following commands:

```
Node_1# configure terminal
Node_1(config)# interface sa1
Node_1(config-if)# switchport atmf-crosslink
```

Example 2B To make static aggregator sa1 an AMF crosslink, use the following commands for good practice:

```
Node_1# configure terminal
Node_1(config)# interface sa1
Node_1(config-if)# switchport atmf-crosslink
Node_1(config-if)# switchport trunk allowed vlan add 2
Node_1(config-if)# switchport trunk native vlan none
```

In this example VLAN 2 is assigned to the static aggregator, and the native VLAN (VLAN 1) is explicitly excluded from the aggregated ports and the crosslink assigned to it.

NOTE: *The AMF management and domain VLANs are automatically added to the aggregator and the crosslink.*

Related commands [show atmf links statistics](#)

switchport atmf-guestlink

Overview Guest links are used to provide basic AMF functionality to non AMF capable devices. Guest links can be configured for either a selected switch port or a range of switch ports and use generic protocols to collect status and configuration information that the guest devices make available.

Use the **no** variant of this command to remove the guest node functionality from the selected port or ports.

NOTE: AMF guest nodes are not supported on ports using the OpenFlow protocol.

Syntax `switchport atmf-guestlink [class <guest-class>] [ip <A.B.C.D> | ipv6 <X:X::X:X>]`
`no switchport atmf-guestlink`

Parameter	Description
<code>class</code>	Set a guest class
<code><guest-class></code>	The name of the guest class.
<code>ip</code>	Specifies that the address following will have an IPv4 format
<code><A.B.C.D></code>	The guest node's IP address in IPv4 format.
<code>ipv6</code>	Specifies that the address following will have an IPv6 format
<code><X:X::X:X></code>	The guest node's IP address in IPv6 format.

Default No guest links are configured.

Mode Interface

Example 1 To configure switchport port1.0.1 to be a guest link, that will connect to a guest node having a guest class of **camera** and an IPv4 address of **192.168.3.3**, use the following commands:

```
node1# configure terminal
node1(config)# int port1.0.1
node1(config-if)# switchport atmf-guestlink class camera ip
192.168.3.3
```

Example 2 To configure switchport port1.0.1 to be a guest link, which will connect to a guest node having a guest class of **phone** and an IPv6 address of **2001:db8:21e:10d::5**, use the following commands:

```
node1# configure terminal
node1(config)# int port1.0.1
node1(config-if)# switchport atmf-guestlink class phone ipv6
2000:db8:21e:10d::5
```

Example 3 To configure switchport port1.0.1 to be a guest link, using the default model type and learning method address, use the following commands:

```
node1# configure terminal
node1(config)# int port1.0.1
node1(config-if)# switchport atmf-guestlink
```

Example 4 To configure switchports port1.0.1 to port1.0.3 to be guest links, for the guest class **camera**, use the following commands:

```
node1# configure terminal
node1(config)# int port1.0.1-port1.0.3
node1(config-if)# switchport atmf-guestlink class camera
```

Example 5 To remove the guest-link functionality from switchport port1.0.1, use the following commands:

```
node1# configure terminal
node1(config)# int port1.0.1
node1(config-if)# no switchport atmf-guestlink
```

Related commands

- atmf guest-class
- discovery
- http-enable
- username (atmf-guest)
- modeltype
- show atmf links guest
- show atmf guests

switchport atmf-link

Overview This command enables you to configure a port or aggregator to be an up/down AMF link. Running this command will automatically place the port or aggregator into trunk mode. If the port was previously configured in access mode, the configured access VLAN will be removed.

Use the **no** variant of this command to remove any AMF link that may exist for the selected port or aggregated link.

Syntax `switchport atmf-link`
`no switchport atmf-link`

Mode Interface Configuration for a switchport, a static aggregator or a dynamic channel group.

Usage notes Up/down links and virtual links interconnect domains in a vertical hierarchy, with the highest domain being the core domain. In effect, they form a tree of interconnected AMF domains. This tree must be loop-free. Therefore you must configure your up/down and virtual links so that no loops are formed.

Within each domain, cross-links between AMF nodes define those nodes as siblings within the same domain. You can form rings by combining cross-links with up/down links and/or virtual links, as long as each AMF domain links upwards to only a single parent domain. Each domain may link downwards to multiple child domains.

NOTE: See the [atmf-link](#) command to configure an AMF up/down link on an AR-series Eth interface.

Example To configure switchport port1.0.1 as an AMF up/down link, use the commands:

```
Node_1# configure terminal
Node_1(config)# interface port1.0.1
Node_1(config-if)# switchport atmf-link
```

To remove switchport port1.0.1 as an AMF up/down link, use the commands:

```
Node_1# configure terminal
Node_1(config)# interface port1.0.1
Node_1(config-if)# no switchport atmf-link
```

Related commands [atmf-link](#)
[show atmf detail](#)
[show atmf links](#)

type atmf guest

Overview This command configures a trigger to activate when an AMF guest node joins or leaves.

Syntax `type atmf guest {join|leave}`

Parameter	Description
join	AMF guest node joins.
leave	AMF guest node leaves.

Mode Trigger Configuration

Example To configure trigger 86 to activate when an AMF guest node leaves, use the following commands:

```
awplus(config)# trigger 86  
awplus(config-trigger)# type atmf guest leave
```

Related commands [show trigger](#)

Command changes Version 5.5.1-1.1: command added

type atmf node

Overview This command configures a trigger to activate when an AMF node joins or leaves.

Syntax type atmf node {join|leave}

Parameter	Description
join	AMF node joins.
leave	AMF node leaves.

Mode Trigger Configuration

Example 1 To configure trigger 5 to activate when an AMF node leaves, use the following commands. In this example the command is entered on node-1:

```
node1(config)# trigger 5
node1(config-trigger)# type atmf node leave
```

Example 2 The following commands will configure trigger 5 to activate if an AMF node join event occurs on any node within the working set:

```
node1# atmf working-set group all
```

This command returns the following display:

```
=====
node1, node2, node3:
=====

Working set join
```

Note that the running the above command changes the prompt from the name of the local node, to the name of the AMF-Network followed, in square brackets, by the number of member nodes in the working set.

```
AMF-Net[3]# conf t
AMF-Net[3](config)# trigger 5
AMF-Net[3](config-trigger)# type atmf node leave
AMF-Net[3](config-trigger)# description "E-mail on AMF Exit"
AMF-Net[3](config-trigger)# active
```

Enter the name of the script to run at the trigger event.

```
AMF-Net[3](config-trigger)# script 1 email_me.scp
AMF-Net[3](config-trigger)# end
```

Display the trigger configurations

```
AMF-Net[3]# show trigger
```

This command returns the following display:

```
=====
node1:
=====

TR# Type & Details      Description          Ac Te Tr Repeat      #Scr Days/Date
-----
001 Periodic (2 min)    Periodic Status Chk Y  N  Y Continuous    1  smtwtfS
005 ATMF node (leave)  E-mail on ATMF Exit Y  N  Y Continuous    1  smtwtfS
-----

=====
Node2, Node3,
=====

TR# Type & Details      Description          Ac Te Tr Repeat      #Scr Days/Date
-----
005 ATMF node (leave)  E-mail on ATMF Exit Y  N  Y Continuous    1  smtwtfS
-----
```

Display the triggers configured on each of the nodes in the AMF Network.

```
AMF-Net[3]# show running-config trigger
```

This command returns the following display:

```
=====
Node1:
=====

trigger 1
  type periodic 2
  script 1 atmf.scp
trigger 5
  type atmf node leave
description "E-mail on ATMF Exit"
  script 1 email_me.scp
!

=====
Node2, Node3:
=====

trigger 5
  type atmf node leave
description "E-mail on ATMF Exit"
  script 1 email_me.scp
!
```

Related commands [show trigger](#)

undebbug atmf

Overview This command is an alias for the **no** variant of the [debug atmf](#) command.

username (atmf-guest)

Overview This command enables you to assign a **username** to a guest class. Guests may require a username and possibly also a password. The password must be between 1 and 32 characters and will allow spaces.

Syntax `username <name> password [8] <userpass>`
`no username`

Parameter	Description
<code><name></code>	User name of the guest node.
8	The parameter 8 means that the password that follows is in hashed form, not plain text. Do not type this 8 when creating a password with this command; it is only used in configuration files. In configuration files, the device prints 8 in front of passwords, to indicate that it is displaying the password in its hashed form.
<code><userpass></code>	The password to be entered for the guest node.

Default No usernames are configured

Mode AMF Guest Configuration

Example To assign the user name 'reception' and the password of 'secret' to an AMF guest node that has the guest class of 'phone1' use the following commands:

```
node1# configure terminal
node1(config)# amf guest-class phone1
node1(config-atmf-guest)# username reception password secret
```

To remove a guest node username and password for the user guest class 'phone1', use the following commands:

```
node1# configure terminal
node1(config)# atmf guest-class phone1
node1(config-atmf-guest)# no username
```

Related commands

- [show atmf links detail](#)
- [atmf guest-class](#)
- [switchport atmf-guestlink](#)
- [show atmf links guest](#)
- [show atmf nodes](#)

52

Autonomous Wave Control Commands

Introduction

Overview This chapter provides an alphabetical reference of commands used to configure *Autonomous Wave Control (AWC)*.

AWC is an advanced network technology that utilizes game theory to deliver significant improvements in wireless network connectivity and performance. AWC can automatically minimize coverage gaps and reduce Access Point (AP) interference and respond to network configuration changes and bandwidth demands from user devices.

You can configure AWC through the command line, or through the Device GUI.

The Auto Setup feature configures your wireless network automatically. AP configuration is created for discovered APs including their IP addresses and MAC addresses. The AP profile is created automatically by the model name. The network and security is created using defined default values.

For more information, see the [Vista Manager mini User Guide](#).

- Command List**
- ["3gpp-info \(wireless-network-passpoint-dot11u\)"](#) on page 2767
 - ["additional-step-required enable \(wireless-network-passpoint-dot11u\)"](#) on page 2768
 - ["airtime-fairness enable \(wireless-ap-prof-radio\)"](#) on page 2769
 - ["anqp-domain-id \(wireless-network-passpoint-hs20\)"](#) on page 2771
 - ["anqp-element \(wireless-network-passpoint-dot11u\)"](#) on page 2772
 - ["antenna \(wireless-ap-prof-radio\)"](#) on page 2773
 - ["ap"](#) on page 2774
 - ["ap-profile \(wireless\)"](#) on page 2775
 - ["ap-profile \(wireless-ap\)"](#) on page 2776
 - ["association-advertisement enable"](#) on page 2777
 - ["authentication \(wireless-sec-wep\)"](#) on page 2778

- ["auto-discovery disable"](#) on page 2779
- ["band"](#) on page 2780
- ["band-steering \(wireless-network\)"](#) on page 2781
- ["bandwidth \(wireless-ap-prof-radio\)"](#) on page 2782
- ["bcast-key-refresh-interval \(wireless-sec-osen\)"](#) on page 2783
- ["bcast-key-refresh-interval \(wireless-sec-wpa-ent\)"](#) on page 2784
- ["bcast-key-refresh-interval \(wireless-sec-wpa-psnl\)"](#) on page 2785
- ["captive-portal"](#) on page 2786
- ["bss-trans-manage enable"](#) on page 2787
- ["captive-portal virtual-ip"](#) on page 2788
- ["channels \(wireless-ap-prof-radio\)"](#) on page 2789
- ["channel \(wireless-ap-radio\)"](#) on page 2790
- ["ciphers \(wireless-sec-osen\)"](#) on page 2791
- ["ciphers \(wireless-sec-wpa-ent\)"](#) on page 2792
- ["ciphers \(wireless-sec-wpa-psnl\)"](#) on page 2793
- ["community read-only \(wireless-ap-prof-snmp\)"](#) on page 2794
- ["community trap \(wireless-ap-prof-snmp\)"](#) on page 2796
- ["conn-capability protocol \(wireless-network-passpoint-hs20\)"](#) on page 2797
- ["country-code"](#) on page 2799
- ["day \(wireless-task\)"](#) on page 2800
- ["death-req-timeout \(wireless-network-passpoint-hs20\)"](#) on page 2801
- ["debug wireless"](#) on page 2802
- ["description \(wireless-ap\)"](#) on page 2804
- ["description \(wireless-ap-prof\)"](#) on page 2805
- ["description \(wireless-mac-ft\)"](#) on page 2806
- ["description \(wireless-network\)"](#) on page 2807
- ["description \(wireless-sc-prof\)"](#) on page 2808
- ["description \(wireless-task\)"](#) on page 2809
- ["description \(wireless-trigger\)"](#) on page 2810
- ["dgaf enable \(wireless-network-passpoint-hs20\)"](#) on page 2811
- ["domain-name \(wireless-network-passpoint-dot11u\)"](#) on page 2812
- ["dot11u \(wireless-network-passpoint\)"](#) on page 2813
- ["dtim-period"](#) on page 2814
- ["dup-auth-received \(wireless-network\)"](#) on page 2815
- ["dynamic-vlan enable \(wireless-sec-osen\)"](#) on page 2816

- “enable (wireless-ap-prof-snmp)” on page 2817
- “emergency-mode” on page 2818
- “emergency-mode usb enable” on page 2819
- “emergency-mode usb key” on page 2820
- “emergency-service-reachable enable (wireless-network-passpoint-dot11u)” on page 2822
- “enable (wireless)” on page 2823
- “enable (wireless-ap)” on page 2824
- “enable (wireless-ap-prof-radio)” on page 2825
- “enable (wireless-network-cp)” on page 2826
- “enable (wireless-network-passpoint)” on page 2827
- “enable (wireless-sec-wep)” on page 2828
- “enable (wireless-task)” on page 2829
- “enable (wireless-wds)” on page 2830
- “external-page-url” on page 2831
- “filter-entry” on page 2832
- “force-disable (wireless-ap-radio)” on page 2834
- “gas-address-behavior (wireless-network-passpoint-dot11u)” on page 2835
- “gas-comeback-delay (wireless-network-passpoint-dot11u)” on page 2836
- “hessid (wireless-network-passpoint-dot11u)” on page 2837
- “hide-ssid (wireless-network)” on page 2838
- “hs20 (wireless-network-passpoint)” on page 2839
- “hwtype” on page 2840
- “index” on page 2842
- “initialization-button enable” on page 2843
- “internet-access enable (wireless-network-passpoint-dot11u)” on page 2844
- “ip-addr-type-availability (wireless-network-passpoint-dot11u)” on page 2845
- “ip-address (wireless-ap)” on page 2847
- “key (wireless-sc-prof)” on page 2848
- “key (wireless-sec-wep)” on page 2849
- “key (wireless-sec-wpa-psnl)” on page 2851
- “l2tif enable (wireless-network-passpoint-hs20)” on page 2852
- “led enable” on page 2853
- “legacy-rates” on page 2854

- ["length \(wireless-sec-wep\)"](#) on page 2855
- ["log enable destination"](#) on page 2856
- ["log interval neighbor-ap"](#) on page 2857
- ["log rotate neighbor-ap"](#) on page 2858
- ["log rotate wireless-client"](#) on page 2859
- ["log size wireless-client"](#) on page 2860
- ["login username \(wireless-ap\)"](#) on page 2861
- ["login-password \(wireless-ap\)"](#) on page 2862
- ["mac-address \(wireless-ap\)"](#) on page 2863
- ["mac-auth password"](#) on page 2864
- ["mac-auth radius auth group \(wireless-network\)"](#) on page 2865
- ["mac-auth username"](#) on page 2866
- ["management address"](#) on page 2868
- ["management-frame-protection enable \(wireless-sec-osen\)"](#) on page 2869
- ["management-frame-protection enable \(wireless-sec-wpa-ent\)"](#) on page 2871
- ["management-frame-protection enable \(wireless-sec-wpa-psnl\)"](#) on page 2873
- ["max-clients"](#) on page 2875
- ["mode \(wireless-ap-prof-radio\)"](#) on page 2876
- ["mode \(wireless-network-cp\)"](#) on page 2878
- ["nai-realm \(wireless-network-passpoint-dot11u\)"](#) on page 2880
- ["neighbor-ap-detection enable"](#) on page 2882
- ["neighbor-managed-ap-detection enable"](#) on page 2883
- ["network-auth-type \(wireless-network-passpoint-dot11u\)"](#) on page 2884
- ["network-type \(wireless-network-passpoint-dot11u\)"](#) on page 2886
- ["network \(wireless\)"](#) on page 2888
- ["ntp designated-server"](#) on page 2889
- ["ntp designated-server enable"](#) on page 2890
- ["ntp designated-server period"](#) on page 2891
- ["operating-class \(wireless-network-passpoint-hs20\)"](#) on page 2892
- ["operator \(wireless-network-passpoint-hs20\)"](#) on page 2893
- ["osu-providers friendly-name lang name"](#) on page 2894
- ["osu-providers icon lang file"](#) on page 2896
- ["osu-providers method-list"](#) on page 2898

- ["osu-providers nai"](#) on page 2900
- ["osu-providers server-uri"](#) on page 2902
- ["osu-providers service-desc lang desc"](#) on page 2903
- ["osu ssid"](#) on page 2905
- ["osu status enable"](#) on page 2907
- ["outdoor"](#) on page 2908
- ["page-proxy-url"](#) on page 2909
- ["passpoint"](#) on page 2910
- ["peer \(wireless-wds\)"](#) on page 2911
- ["permit host \(wireless-ap-prof-snmp\)"](#) on page 2912
- ["port \(wireless-ap-prof-snmp\)"](#) on page 2913
- ["power \(wireless-ap-radio\)"](#) on page 2914
- ["pre-authentication enable \(wireless-sec-osen\)"](#) on page 2915
- ["pre-authentication enable \(wireless-sec-wpa-ent\)"](#) on page 2916
- ["proxy-arp enable"](#) on page 2917
- ["qos-map-set \(wireless-network-passpoint-dot11u\)"](#) on page 2918
- ["radio \(wireless-ap\)"](#) on page 2919
- ["radio \(wireless-ap-profile\)"](#) on page 2920
- ["radius accounting enable"](#) on page 2921
- ["radius auth group \(wireless-network-cp\)"](#) on page 2922
- ["radius authentication group \(wireless-sec-osen\)"](#) on page 2924
- ["radius auth group \(wireless-sec-wpa-ent\)"](#) on page 2925
- ["redirect-url"](#) on page 2926
- ["rogue-ap-detection enable \(wireless\)"](#) on page 2928
- ["roaming-oi \(wireless-network-passpoint-dot11u\)"](#) on page 2929
- ["sc-profile"](#) on page 2930
- ["sc-channel"](#) on page 2931
- ["security \(wireless\)"](#) on page 2932
- ["security \(wireless-network\)"](#) on page 2934
- ["security \(wireless-wds\)"](#) on page 2935
- ["service wireless"](#) on page 2936
- ["session-keep"](#) on page 2937
- ["session-key-refresh-action"](#) on page 2938
- ["session-key-refresh-interval"](#) on page 2939
- ["session-timeout-action \(wireless network-cp\)"](#) on page 2940

- [“session-timeout-interval \(wireless network-cp\)”](#) on page 2941
- [“show debugging wireless”](#) on page 2942
- [“show wireless”](#) on page 2943
- [“show wireless ap”](#) on page 2944
- [“show wireless ap capability”](#) on page 2951
- [“show wireless ap client”](#) on page 2953
- [“show wireless ap neighbors”](#) on page 2954
- [“show wireless ap power-channel”](#) on page 2955
- [“show wireless ap-profile”](#) on page 2956
- [“show wireless auto-config”](#) on page 2960
- [“show wireless captive-portal network walled-garden”](#) on page 2963
- [“show wireless country-code”](#) on page 2964
- [“show wireless network”](#) on page 2965
- [“show wireless power-channel calculate”](#) on page 2970
- [“show wireless sc-profile”](#) on page 2971
- [“show wireless security”](#) on page 2973
- [“show wireless smart-connect ap”](#) on page 2975
- [“show wireless task”](#) on page 2976
- [“show wireless wds”](#) on page 2979
- [“show wireless wireless-mac-filter”](#) on page 2981
- [“show wireless wireless-trigger”](#) on page 2983
- [“smart-connect-profile”](#) on page 2984
- [“snmp \(wireless-ap-prof\)”](#) on page 2985
- [“ssid \(wireless-network\)”](#) on page 2986
- [“ssid \(wireless-sc-prof\)”](#) on page 2987
- [“station-isolation enable \(wireless-ap-prof-radio\)”](#) on page 2988
- [“task”](#) on page 2989
- [“time \(wireless-task\)”](#) on page 2990
- [“trap host \(wireless-ap-prof-snmp\)”](#) on page 2991
- [“type \(wireless-sec-wep\)”](#) on page 2992
- [“type ap-configuration apply ap”](#) on page 2993
- [“type download ap \(wireless-task\)”](#) on page 2994
- [“type power-channel ap all”](#) on page 2995
- [“unauth-emergency-service-access enable \(wireless-network-passpoint-dot11u\)”](#) on page 2996

- [“username \(wireless-ap-prof-snm\)”](#) on page 2997
- [“vap \(wireless-ap-prof-radio\)”](#) on page 2999
- [“venue group \(wireless-network-passpoint-dot11u\)”](#) on page 3000
- [“venue name \(wireless-network-passpoint-dot11u\)”](#) on page 3001
- [“venue type \(wireless-network-passpoint-dot11u\)”](#) on page 3002
- [“version \(wireless-ap-prof-snm\)”](#) on page 3003
- [“versions \(wireless-sec-osen\)”](#) on page 3004
- [“versions \(wireless-sec-wpa-ent\)”](#) on page 3005
- [“versions \(wireless-sec-wpa-psnl\)”](#) on page 3006
- [“vlan \(wireless-network\)”](#) on page 3007
- [“walled-garden entry”](#) on page 3008
- [“wan-metrics downlink-load \(wireless-network-passpoint-hs20\)”](#) on page 3010
- [“wan-metrics downlink-speed \(wireless-network-passpoint-hs20\)”](#) on page 3011
- [“wan-metrics info \(wireless-network-passpoint-hs20\)”](#) on page 3012
- [“wan-metrics load-measure-duration \(wireless-network-passpoint-hs20\)”](#) on page 3014
- [“wan-metrics uplink-load \(wireless-network-passpoint-hs20\)”](#) on page 3015
- [“wan-metrics uplink-speed \(wireless-network-passpoint-hs20\)”](#) on page 3016
- [“wds”](#) on page 3017
- [“wds radio \(wireless-ap\)”](#) on page 3018
- [“web-auth radius auth group”](#) on page 3019
- [“wireless”](#) on page 3020
- [“wireless ap-configuration apply ap”](#) on page 3021
- [“wireless auto-config”](#) on page 3022
- [“wireless download ap url”](#) on page 3024
- [“wireless emergency-mode”](#) on page 3026
- [“wireless emergency-mode usb mark key”](#) on page 3027
- [“wireless export”](#) on page 3029
- [“wireless get-tech abort”](#) on page 3030
- [“wireless get-tech ap”](#) on page 3031
- [“wireless get-tech ap-profile”](#) on page 3032
- [“wireless get-tech sc-profile”](#) on page 3033
- [“wireless import”](#) on page 3034

- “[wireless power-channel ap all](#)” on page 3035
- “[wireless reset ap](#)” on page 3036
- “[wireless-mac-filter \(wireless\)](#)” on page 3037
- “[wireless-mac-filter \(wireless-ap-prof\)](#)” on page 3038
- “[wireless-mac-filter enable](#)” on page 3040
- “[wireless wireless-trigger](#)” on page 3041
- “[wireless-trigger](#)” on page 3042
- “[wireless-trigger-id](#)” on page 3043

3gpp-info (wireless-network-passpoint-dot11u)

Overview Use this command to set the 3GPP (802.11u 3rd Generation Partnership Project) cellular network information.

Use the **no** variant of this command to revert to the default value.

Syntax `3gpp-info <code-list>`
`no 3gpp-info`

Parameter	Description
<code><code-list></code>	<p>Enter the MCC (Mobile Country Code) and MNC (Mobile Network Code):</p> <ul style="list-style-type: none">• MCC must be a 3 digit decimal number• MNC must be a 2 or 3 digit decimal number• MCC and MNC must be separated by commas• If setting multiple combinations of MCC and MNC, they must be separated by semicolons.• A maximum of 100 characters can be set including commas and semicolons. <p>For more information on mobile country and network codes, go to: Wikipedia Mobile Country Codes.</p>

Default Not set.

Mode Wireless Network Passpoint 802.11u Configuration

Example To set some of the MCC and MNC codes for Japan, use the commands:

```
awplus# configure terminal
awplus(config)# wireless
awplus(config-wireless)# network 1
awplus(config-wireless-network)# passpoint
awplus(config-wireless-network-passpoint)# dot11u
awplus(config-wireless-network-passpoint-dot11u)# 3gpp-info
440,00;440,50
```

Related commands [show wireless network](#)
[dot11u \(wireless-network-passpoint\)](#)

Command changes Version 5.5.0-2.3: command added

additional-step-required enable (wireless-network-passpoint-dot11u)

Overview Use this command to configure an Additional Step Required for Access.
Use the **no** variant of this command to disable Additional Step Required for Access.

Syntax `additional-step-required enable`
`no additional-step-required enable`

Default Disabled.

Mode Wireless Network Passpoint 802.11u Configuration

Usage notes Typically, access and authentication is automatic if a legacy hotspot is operated by the mobile device's Home Service Provider (SP) or if the user has previously authenticated to that hotspot. Additionally, user intervention is typically required in a roaming environment where the hotspot is not operated by the Home SP and additional steps are required to identify and authenticate with the Home SP.

Example To enable Additional Step Required for Access, use the commands:

```
awplus# configure terminal
awplus(config)# wireless
awplus(config-wireless)# network 1
awplus(config-wireless-network)# passpoint
awplus(config-wireless-network-passpoint)# dot11u
awplus(config-wireless-network-passpoint-dot11u)#
additional-step-required enable
```

Related commands [show wireless network](#)
[dot11u \(wireless-network-passpoint\)](#)

Command changes Version 5.5.0-2.3: command added

airtime-fairness enable (wireless-ap-prof-radio)

Overview Use this command to enable **airtime-fairness** for all wireless clients regardless of speed.

Use the **no** variant of this command to disable airtime-fairness for all wireless clients.

Syntax `airtime-fairness enable`
`no airtime-fairness enable`

Default Disabled.

Mode Wireless AP Profile Radio Configuration

Usage notes Airtime-fairness ensures that every client has equal access to air time, regardless of client capability. Client capability includes the wireless standard 802.11 mode and Radio Frequency (RF) link signal strength.

If two clients were each assigned a 10 Mbps bandwidth and sending equally sized frames then they potentially could have unequal air time if their RF link characteristics were different.

RF link characteristics are based upon the distance of the client from the Access Point (AP). A client that is closer to the AP typically operates at a higher data rate than a client farther from the AP. This is because the AP and client are deliberately designed to adapt their transmission rates in order to maintain an optimal quality of the RF link.

This behavior is normal between the AP and clients since the client devices are not expected to remain at a constant or equal distance from the AP. This could mean that one device is consuming more airtime than it is entitled to, even though that device is not consuming more than its bandwidth limit.

Note: This command is valid on TQ series devices only.

Example To enable airtime-fairness for 'radio 2' on 'ap-profile100' use the following commands:

```
awplus# configure terminal
awplus(config)# wireless
awplus(config-wireless)# ap-prof 100
awplus(config-wireless-ap-prof)# ap-prof 100
awplus(config-wireless-ap-prof-radio)# radio 2
awplus(config-wireless-ap-prof-radio)# airtime-fairness enable
```

Related commands [radio \(wireless-ap-profile\)](#)

Command changes Version 5.4.7-2.4: command added.

anqp-domain-id (wireless-network-passpoint-hs20)

Overview Use this command to set the ANQP (Access Network Query Protocol) domain identifier.

Use the **no** variant of this command to reset the ANQP domain identifier to the default value.

Syntax `anqp-domain-id <0-65535>`
`no anqp-domain-id`

Parameter	Description
<code><0-65535></code>	ANQP domain identifier.

Default 0

Mode Wireless Network Passpoint Hotspot 2.0 Configuration

Example To set the ANQP domain identifier on network 1, use the commands:

```
awplus# configure terminal
awplus(config)# wireless
awplus(config-wireless)# network 1
awplus(config-wireless-network)# passpoint
awplus(config-wireless-network-passpoint)# hs20
awplus(config-wireless-network-passpoint-hs20)# anqp-domain-id
1
```

Related commands [show wireless network](#)
[hs20 \(wireless-network-passpoint\)](#)

Command changes Version 5.5.0-2.3: command added

anqp-element (wireless-network-passpoint-dot11u)

Overview Use this command to configure the Arbitrary Access Network Query Protocol (ANQP) element.

ANQP is a query and response protocol that defines services offered by an access point (AP), typically at a Wi-Fi hot spot.

Use the **no** variant of this command to remove a specified ANQP element entry.

Syntax `anqp-element info-id <0-999> payload HEX`
`no anqp-element info-id <0-999>`

Parameter	Description
<0-999>	Arbitrary ANQP element configuration's unique entry number.
HEX	Arbitrary ANQP element configuration. The maximum number of characters in HEX is 100.

Default Not set.

Mode Wireless Network Passpoint 802.11u Configuration

Example To configure the ANQP element info ID to '1' and the payload HEX value to '0000', use the commands:

```
awplus# configure terminal
awplus(config)# wireless
awplus(config-wireless)# network 1
awplus(config-wireless-network)# passpoint
awplus(config-wireless-network-passpoint)# dot11u
awplus(config-wireless-network-passpoint-dot11u)# anqp-element
info-id 1 payload 0000
```

Related commands [show wireless network](#)
[dot11u \(wireless-network-passpoint\)](#)

Command changes Version 5.5.0-2.3: command added

antenna (wireless-ap-prof-radio)

Overview Use the antenna command to set the antenna model for a wireless Access Point (AP).

Use the **no** variant of this command to remove the designated antenna model for a wireless AP.

Syntax antenna {an2458-10dp|an5158-16dp|an5158-19dp}
no antenna

Parameter	Description
an2458-10dp	Antenna model AN2458-10DP
an5158-16dp	Antenna model AN5158-16DP
an5158-19dp	Antenna model AN5158-19DP

Default Not set.

Mode Wireless AP Profile Radio Configuration

Example To configure an AP radio configuration to use the antenna model AN5158-19DP, use the following commands:

```
awplus# configure terminal
awplus(config)# wireless
awplus(config-wireless)# ap-profile 100
awplus(config-wireless-ap)# hwtype tq single spec 11n
awplus(config-wireless-ap)# band 5
awplus(config-wireless-ap)# radio 1
awplus(config-wireless-ap-radio)# antenna an5158-19dp
```

Related commands [hwtype](#)
[band](#)
[radio \(wireless-ap-profile\)](#)

Command changes Version 5.4.7-2.4: command added

ap

Overview Use this command to configure an Access Point (AP).
If the AP doesn't already exist, then this command creates it.
Use the **no** variant of this command to remove an AP configuration.

Syntax `ap <1-65535>`

Parameter	Description
<code><1-65535></code>	AP configuration ID number.

Default Not set.

Mode Wireless Configuration

Usage notes This command adds an AP configuration and enters the AP configuration mode.

Example To configure an AP with an ID of 10, use the following commands:

```
awplus# configure terminal
awplus(config)# wireless
awplus(config-wireless)# ap 10
```

Related commands

- [wireless](#)
- [enable \(wireless-ap\)](#)
- [description \(wireless-ap\)](#)
- [ap-profile \(wireless\)](#)
- [ip-address \(wireless-ap\)](#)
- [mac-address \(wireless-ap\)](#)
- [login username \(wireless-ap\)](#)
- [login-password \(wireless-ap\)](#)
- [wds radio \(wireless-ap\)](#)
- [radio \(wireless-ap-profile\)](#)

Command changes Version 5.4.7-2.4: command added.

ap-profile (wireless)

Overview Use this command to configure an AP (Access Point) profile. If the AP profile doesn't already exist, then this command creates it.

Use the **no** variant of this command to delete an AP profile.

Syntax `ap-profile <1-65535>`
`no ap-profile <1-65535>`

Parameter	Description
<code><1-65535></code>	The AP profile ID number.

Default Not set.

Mode Wireless Configuration

Example To configure an AP profile with the ID profile number of 10, use the following commands:

```
awplus# configure terminal
awplus(config)# wireless
awplus(config-wireless)# ap-profile 10
```

To remove the AP profile 10, use the following commands:

```
awplus# configure terminal
awplus(config)# wireless
awplus(config-wireless)# no ap-profile 10
```

Related commands

- [show wireless ap-profile](#)
- [description \(wireless-ap-prof\)](#)
- [hwtype](#)
- [outdoor](#)
- [ntp designated-server](#)
- [led enable](#)
- [radio \(wireless-ap-profile\)](#)
- [show wireless ap-profile](#)

Command changes Version 5.4.7-2.4: command added

ap-profile (wireless-ap)

Overview Use this command to set an Access Point (AP) Profile to an AP.
Use the **no** variant of this command to delete an AP Profile.

Syntax `ap-profile <1-65535>`
`no ap-profile`

Parameter	Description
<code><1-65535></code>	AP Profile configuration ID number.

Default Not set.

Mode Wireless AP Configuration

Example To set AP Profile (ap-profile 100) to the AP 1 configuration, use the following commands:

```
awplus# configure terminal
awplus(config)# wireless
awplus(config-wireless)# ap 1
awplus(config-wireless-ap)# ap-profile 100
```

Related commands [ap](#)
[ap-profile \(wireless\)](#)
[show wireless ap](#)

Command changes Version 5.4.7-2.4: command added.

association-advertisement enable

Overview Use this command to enable an Association Advertisement on the network configuration.

Use the **no** variant of this command to disable the Association Advertisement on the network configuration.

Syntax `association-advertisement enable`
`no association-advertisement enable`

Default Disabled.

Mode Wireless Network Configuration

Example To enable the Association Advertisement for network 1, use the commands:

```
awplus# configure terminal
awplus(config)# wireless
awplus(config-wireless)# network 1
awplus(config-wireless-network)# association-advertisement
enable
```

Related commands [show wireless network](#)
[network \(wireless\)](#)

Command changes Version 5.5.1-0.1: command added

authentication (wireless-sec-wep)

Overview Use this command to enable or disable authentication on a wireless Access Point (AP).

Syntax authentication {both|open-system|shared-key}

Parameter	Description
both	Use both types of authentication: open-system and shared-key authentication.
open-system	No authentication.
shared-key	WEP authentication.

Default Open-system.

Mode Wireless Security WEP Configuration

Usage notes For **MWS** series devices, select either the open-system or shared-key parameter. You can't select the **both** parameter.

Example To configure WEP as the security authentication mode for clients, use the following commands:

```
awplus# configure terminal
awplus(config)# wireless
awplus(config-wireless)# security 10 mode wep
awplus(config-wireless-sec-wep)# authentication shared-key
```

Related commands [security \(wireless\)](#)

Command changes Version 5.4.7-2.4: command added.

auto-discovery disable

Overview Use this command to disable the automatic search for new APs in an AWC Smart Connect (AWC-SC) network.

Use the **no** variant of this command to enable the automatic search for new APs.

Syntax auto-discovery disable
no auto-discovery disable

Default Enabled

Mode Wireless Smart Connect Profile Configuration

Usage notes Auto-discovery is a function that allows an AP that is in the factory default state to automatically become part of an AWC-SC network. This is because when a wireless AP is activated in the factory default state, its IP and MAC address are added to the AP profile and the Smart Connect profile.

Example To turn auto-discovery off for Smart Connect profile 10, use the commands:

```
awplus# configure terminal
awplus(config)# wireless
awplus(config-wireless)# smart-connect-profile 10
awplus(config-wireless-sc-prof)# auto-discovery disable
```

Related commands [smart-connect-profile](#)

Command changes Version 5.5.0-0.1: command added

band

Overview Use this command to assign a frequency band to a single antenna wireless AP. Use the **no** variant of this command to set the band to the default value of 2.

Syntax band {2|5}
no band

Parameter	Description
2	2.4GHz band
5	5GHz band

Default The default band is 2 (2.4GHz).

Mode Wireless AP Profile Configuration

Usage notes The command can only be used with single antenna APs.

Example To configure a 5GHz band for a single antenna AP, use the following commands:

```
awplus# configure terminal
awplus(config)# wireless
awplus(config-wireless)# ap-profile 2
awplus(config-wireless-ap-prof)# band 5
```

Related commands [ap-profile \(wireless\)](#)
[show wireless ap-profile](#)
[antenna \(wireless-ap-prof-radio\)](#)

Command changes Version 5.4.7-2.4: command added

band-steering (wireless-network)

Overview Use this command to enable band steering on a wireless Access Point (AP).
Use the **no** variant of this command to disable band steering.

Syntax band-steering
no band-steering

Default Disabled.

Mode Wireless Network Configuration

Usage notes Band Steering detects dual-band capable clients and steers them to the 5 GHz frequency. This leaves the more crowded 2.4 GHz band available for legacy clients.
This helps improve end user experience by reducing channel utilization, especially in high density environments
This command is not supported on the **MWS** series products.

Example To enable band steering, use the following commands:

```
awplus# configure terminal
awplus(config)# wireless
awplus(config-wireless)# network 20
awplus(config-wireless-network)# band-steering
```

Related commands [network \(wireless\)](#)
[show wireless network](#)

Command changes Version 5.4.7-2.4: command added.

bandwidth (wireless-ap-prof-radio)

Overview Use this command to assign a bandwidth to an Access Point (AP).
Use the **no** variant of this command to revert to the default bandwidth.

Syntax bandwidth {20|40|80}
no bandwidth

Parameter	Description
20	20MHz bandwidth
40	40MHz bandwidth
80	80MHz bandwidth

Default The default bandwidth value varies according to the configured hardware and radio type.

Mode Wireless AP Profile Radio Configuration

Example To assign a 40MHz bandwidth to AP-profile 100 for Radio 2, use the following commands:

```
awplus# configure terminal
awplus(config)# wireless
awplus(config-wireless)# ap-profile 100
awplus(config-wireless-ap-prof)# radio 2
awplus(config-wireless-ap-prof-radio)# bandwidth 40
```

Related commands [ap-profile \(wireless\)](#)
[country-code](#)
[hwtype](#)
[outdoor](#)
[radio \(wireless-ap-profile\)](#)

Command changes Version 5.4.7-2.4: command added.

bcast-key-refresh-interval (wireless-sec-osen)

Overview Use this command to set the refresh interval for the broadcast (group) key used with an OSEN security configuration.
Use the **no** variant of this command to revert to the refresh interval default value.

Syntax `bcast-key-refresh-interval <0-86400>`
`no bcast-key-refresh-interval`

Parameter	Description
<code><0-86400></code>	The key refresh interval in seconds. The range is 0 to 86400 seconds.

Default Zero (0) is the default.

Mode Wireless Security OSEN Configuration

Usage notes OSEN is a wireless security method used with Release 2 of Hotspot 2.0 (Passpoint). OSEN is short for Online Sign Up (OSU) Server-only Authenticated Layer 2 Encryption Network. Use the **security** command to enter OSEN security configuration mode.

Example To set a broadcast key refresh interval of 3600 for a security configuration, use the commands:

```
awplus# configure terminal
awplus(config)# wireless
awplus(config-wireless)# security 210 mode osen
awplus(config-wireless-sec-osen)# bcast-key-refresh-interval
3600
```

Related commands [security \(wireless\)](#)
[show wireless security](#)

Command changes Version 5.5.0-2.3: command added

bcast-key-refresh-interval (wireless-sec-wpa-ent)

Overview Use this command to set the refresh interval for the broadcast key used in a WPA-enterprise security configuration.
Use the **no** variant of this command to set the refresh interval for the broadcast key to the default.

Syntax `bcast-key-refresh-interval <0-86400>`
`no bcast-key-refresh-interval`

Parameter	Description
<code><0-86400></code>	The refresh interval in seconds For the MWS series , the broadcast key refresh rate is <code><0, 30-3600></code> seconds.

Default The default refresh interval is 0 seconds.

Mode Wireless Security WPA-enterprise Configuration

Example To set 3600 seconds as the broadcast key refresh interval, use the following commands:

```
awplus# configure terminal
awplus(config)# wireless
awplus(config-wireless)# security 210 mode wpa-enterprise
awplus(config-wireless-sec-wpa-ent)#
bcast-key-refresh-interval 3600
```

Related commands [security \(wireless\)](#)

Command changes Version 5.4.7-2.4: command added

bcast-key-refresh-interval (wireless-sec-wpa-psnl)

Overview Use this command to set the refresh interval for a broadcast (group) key used in a WPA-personal security configuration.

Use the **no** variant of this command to set the refresh interval to the default value.

Syntax `bcast-key-refresh-interval <0-86400>`
`no bcast-key-refresh-interval`

Parameter	Description
<code><0-86400></code>	The broadcast key refresh interval. For the MWS series , the broadcast key refresh rate is <code><0, 30-3600></code> seconds.

Default The default value is 0.

Mode Wireless Security WPA-personal Configuration

Example To set the broadcast key refresh interval to 3600 seconds on a WPA-personal security configuration, use the following commands:

```
awplus# configure terminal
awplus(config)# wireless
awplus(config-wireless)# security 110 mode wpa-personal
awplus(config-wireless-sec-wpa-psnl)#
bcast-key-refresh-interval 3600
```

Related commands [security \(wireless\)](#)

Command changes Version 5.4.7-2.4: command added.

captive-portal

Overview Use this command to add a Captive Portal (web authentication) configuration and enter the Captive Portal configuration mode.

Captive Portal lets wireless clients authenticate themselves or agree to terms and conditions before you grant them Wi-Fi access or external web access.

This setting is only valid for AT-TQ series wireless access points.

Use the **no** variant of this command to remove a Captive Portal configuration.

Syntax `captive-portal`
`no captive-portal`

Default Captive Portal is not set.

Mode Wireless Network Configuration

Example To enter the Captive Portal configuration mode of network 20, use the commands:

```
awplus# configure terminal
awplus(config)# wireless
awplus(config-wireless)# network 20
awplus(config-wireless-network)# captive-portal
```

To reset all the Captive Portal configuration settings of network 20, use the commands:

```
awplus# configure terminal
awplus(config)# wireless
awplus(config-wireless)# network 20
awplus(config-wireless-network)# no captive-portal
```

Related commands

- [enable \(wireless-network-cp\)](#)
- [page-proxy-url](#)
- [radius auth group \(wireless-network-cp\)](#)
- [redirect-url](#)
- [session-keep](#)
- [mode \(wireless-network-cp\)](#)

Command changes Version 5.4.9-1.1: command added

bss-trans-manage enable

Overview Use this command to enable Basic Service Set (BSS) Transition Management on a wireless network configuration. The BSS consists of one redistribution point — typically an access point (WAP or AP) interconnecting all associated wireless clients.

Use the **no** variant of this command to disable BSS Transition Management on a wireless network configuration.

Syntax `bss-trans-manage enable`
`no bss-trans-manage enable`

Default Disabled.

Mode Wireless Network Configuration

Example To configure enable BSS Transition Management, use the commands:

```
awplus# configure terminal
awplus(config)# wireless
awplus(config-wireless)# network 20
awplus(config-wireless-network)# bss-trans-manage enable
```

Related commands [show wireless network](#)
[network \(wireless\)](#)

Command changes Version 5.5.0-2.3: command added

captive-portal virtual-ip

Overview Use this command to configure the virtual IP address on Captive Portal.

Captive Portal lets wireless clients authenticate themselves or agree to terms and conditions before you grant them Wi-Fi access or external web access.

Use the **no** variant of this command to remove the virtual IP address on Captive Portal.

Syntax captive-portal virtual-ip <ip-address>
no captive-portal virtual-ip

Parameter	Description
<ip-address>	The IPv4 address uses the format A.B.C.D

Default Not set.

Mode Wireless AP Profile Configuration

Usage notes Captive Portal uses the AP's management IP address to show an authentication page. To avoid a potential security risk, this command allows you to hide the AP management IP address by providing a virtual IP address for Captive Portal authentication.

Example To configure a virtual IP address for Captive Portal, use the commands:

```
awplus# configure terminal
awplus(config)# wireless
awplus(config-wireless)# ap-profile 5
awplus(config-wireless-ap-prof)# captive-portal virtual-ip
1.1.1.1
```

Related commands [show wireless ap-profile](#)
[captive-portal](#)
[page-proxy-url](#)
[radius auth group \(wireless-network-cp\)](#)
[redirect-url](#)
[session-keep](#)
[mode \(wireless-network-cp\)](#)

Command changes Version 5.5.0-1.3: command added

channels (wireless-ap-prof-radio)

Overview Use this command to set the channel that a wireless Access Point (AP) uses when it is set to auto.

Use the **no** variant of this command to return the AP channel to its default.

Syntax channels <1-255>
no channels

Parameter	Description
<1-255>	The channel number.

Default The default channel varies with each type of AP, its country-code, and outdoor settings.

Mode Wireless AP Profile Radio Configuration

Example To set the wireless AP radio channel, use the following commands:

```
awplus# configure terminal
awplus(config)# wireless
awplus(config-wireless)# ap-profile 100
awplus(config-wireless-ap-prof)# radio 1
awplus(config-wireless-ap-prof-radio)# channels 10
```

Related commands [radio \(wireless-ap-profile\)](#)
[hwtype](#)
[outdoor](#)
[country-code](#)

Command changes Version 5.4.7-2.4: command added.

channel (wireless-ap-radio)

Overview Use this command to configure a channel on an Access Point (AP). You can configure an AP to automatically select a channel or use a fixed channel.

Use the **no** variant of this command to remove any configured channels and return to the default value.

Syntax `channel {auto|<1-255>}`
`no channel`

Parameter	Description
auto	The channel is automatically selected.
<1-255>	A list of fixed channels. The list is determined by the country-code.

Default The default is **auto**.

Mode Wireless AP Radio Configuration

Example To configure a fixed channel for an AP, use the following commands:

```
awplus# configure terminal
awplus(config)# wireless
awplus(config-wireless)# ap 100
awplus(config-wireless-ap)# radio 2
awplus(config-wireless-ap-radio)# channel 1
```

Related commands [ap-profile \(wireless\)](#)
[show wireless ap-profile](#)
[country-code](#)
[hwtype](#)
[outdoor](#)

Command changes Version 5.4.7-2.4: command added.

ciphers (wireless-sec-osen)

Overview Use this command to set which cipher suite to use with OSEN wireless security configuration.

Use the **no** variant of this command to revert to the default cipher suite.

Syntax `ciphers <cipher-list>`
`no ciphers`

Parameter	Description
<code><cipher-list></code>	<p>Designate the cipher suite(s) in a list format. The cipher options are either ccmp or tkip or both in any order. The combinations you can select depend on the WPA version as follows:</p> <ul style="list-style-type: none">• If the version is a combination of wpa and wpa2, the cipher suite can be either ccmp only or a combination of ccmp and tkip.• If the version is only wpa2, the cipher suite can be selected from ccmp only or a combination of ccmp and tkip.• If the version is only wpa3, only ccmp can be selected as the cipher suite.

Default **ccmp**

Mode Wireless Security OSEN Configuration

Usage notes OSEN is a wireless security method used with Release 2 of Hotspot 2.0 (Passpoint). OSEN is short for Online Sign Up (OSU) Server-only Authenticated Layer 2 Encryption Network. Use the **security** command to enter OSEN security configuration mode.

Example To configure both ccmp (AES) and tkip as the cipher suite on a security configuration of OSEN, use the commands:

```
awplus# configure terminal
awplus(config)# wireless
awplus(config-wireless)# security 210 mode osen
awplus(config-wireless-sec-osen)# ciphers ccmp tkip
```

Related commands [security \(wireless\)](#)
[show wireless security](#)
[versions \(wireless-sec-osen\)](#)

Command changes Version 5.5.0-2.3: command added

ciphers (wireless-sec-wpa-ent)

Overview Use this command to set the cipher suite(s) used by WPA-personal security configurations. The cipher suites available are: CCMP (AES) and TKIP.

Use the **no** variant of this command to set the default cipher suite used by WPA-personal security configurations.

Syntax `ciphers <cipher-list>`
`no ciphers`

Parameter	Description
<code><cipher-list></code>	The available cipher suite(s) in list format. The list can contain either ccmp or tkip or both and can be in any order.

Default CCMP.

Mode Wireless Security WPA-enterprise Configuration

Usage notes For **MWS** series devices, a combination of versions and ciphers are supported as follows:

- versions wpa2 and ciphers ccmp
- versions wpa, wpa2, and ciphers tkip and ccmp

Example To set both CCMP (AES) and TKIP as cipher suites on a security WPA-enterprise configuration, use the following commands:

```
awplus# configure terminal
awplus(config)# wireless
awplus(config-wireless)# security 210 mode wpa-enterprise
awplus(config-wireless-sec-wpa-ent)# ciphers ccma tkip
```

Related commands [security \(wireless\)](#)

Command changes Version 5.4.7-2.4: command added

ciphers (wireless-sec-wpa-psnl)

Overview Use this command to set the cipher suite(s) used by WPA-personal security configurations. The cipher suites available are: CCMP (AES) and TKIP.

Use the **no** variant of this command to set the default cipher suite used by WPA-personal security configurations.

Syntax `ciphers <cipher-list>`
`no ciphers`

Parameter	Description
<code><cipher-list></code>	The available cipher suite(s) in list format. The list can contain either ccmp or tkip or both and can be in any order.

Default `ccmp`.

Mode Wireless Security WPA-personal Configuration

Usage notes For MWS series devices, a combination of versions and ciphers are supported as follows:

- versions `wpa2` and ciphers `ccmp`
- versions `wpa`, `wpa2`, and ciphers `tkip` and `ccmp`

Example To configure WPA-personal to use both CCMP (AES) and TKIP as cipher suites in a security configuration, use the following commands:

```
awplus# configure terminal
awplus(config)# wireless
awplus(config-wireless)# security 110 mode wpa-personal
awplus(config-wireless-sec-wpa-psnl)# ciphers ccmp tkip
```

Related commands [security \(wireless\)](#)

Command changes Version 5.4.7-2.4: command added.

community read-only (wireless-ap-prof-snmp)

Overview Use this command to set an SNMP read-only community name for the target AP profile. This command is valid for SNMP v1 and v2c only.

Use the **no** variant of this command to set the SNMP read-only community name back to the default (public).

Syntax `community read-only <community-name>`
`no community read-only`

Parameter	Description
<code><community-name></code>	The community name to set. Valid characters are: - alphanumeric characters - symbols except for the following 6 symbols: " '\ & < >

Default public

Mode Wireless AP Profile SNMP Configuration

Example To set the SNMP read-only community name to 'private', use the commands:

```
awplus# configure terminal
awplus(config)# wireless
awplus(config-wireless)# ap-profile 2
awplus(config-wireless-ap-prof)# snmp
awplus(config-wireless-ap-prof-snmp)# community read-only
private
```

To set the SNMP trap community name back to the default (public), use the commands:

```
awplus# configure terminal
awplus(config)# wireless
awplus(config-wireless)# ap-profile 2
awplus(config-wireless-ap-prof)# snmp
awplus(config-wireless-ap-prof-snmp)# no community read-only
```

Related commands [show wireless ap-profile](#)
[snmp \(wireless-ap-prof\)](#)
[version \(wireless-ap-prof-snmp\)](#)

Command changes Version 5.5.1-1.1: valid character set changed

Version 5.5.0-2.1: command added

community trap (wireless-ap-prof-snmp)

Overview Use this command to set an SNMP trap community name for the target AP profile. This command is valid for SNMP v1 and v2c only.

Use the **no** variant of this command to set the SNMP trap community name to the default (public).

Syntax `community trap <community-name>`
`no community trap`

Parameter	Description
<code><community-name></code>	The community name to set. Valid characters are: - alphanumeric characters - symbols except for the following 6 symbols: " '\ & < >

Default public

Mode Wireless AP Profile SNMP Configuration

Example To set the SNMP trap community name to 'private', use the commands:

```
awplus# configure terminal
awplus(config)# wireless
awplus(config-wireless)# ap-profile 2
awplus(config-wireless-ap-prof)# snmp
awplus(config-wireless-ap-prof-snmp)# community trap private
```

To set the SNMP trap community name back to the default (public), use the commands:

```
awplus# configure terminal
awplus(config)# wireless
awplus(config-wireless)# ap-profile 2
awplus(config-wireless-ap-prof)# snmp
awplus(config-wireless-ap-prof-snmp)# no community trap
```

Related commands [show wireless ap-profile](#)
[snmp \(wireless-ap-prof\)](#)
[version \(wireless-ap-prof-snmp\)](#)

Command changes Version 5.5.1-1.1: valid character set changed
Version 5.5.0-2.1: command added

conn-capability protocol (wireless-network-passpoint-hs20)

Overview Use this command to specify the protocols supported by the network connection and the corresponding port numbers and whether the port is open or closed.

Use the **no** variant of this command to remove the settings for the specified protocol number.

Syntax `conn-capability protocol <0-255> port <0-65535> status [closed|open|unknown]`
`no conn-capability protocol <0-255>`

Parameter	Description
<0-255>	Protocol number, as in the assigned protocol numbers listed at: www.iana.org .
<0-65535>	Port number
closed	Indicates the connection is in closed mode
open	Indicates the connection is in open mode
unknown	Indicates the connection status is unknown

Default Not set.

Mode Wireless Network Passpoint Hotspot 2.0 Configuration

Usage notes These settings signify the capabilities of the wired network that the AP is connected to. They provide information on the connection status of the most commonly used communication protocols and ports within the hotspot.

Example To set the connection capability on port 161 to 'closed' for protocol 17 (UDP), use the commands:

```
awplus# configure terminal
awplus(config)# wireless
awplus(config-wireless)# network 1
awplus(config-wireless-network)# passpoint
awplus(config-wireless-network-passpoint)# hs20
awplus(config-wireless-network-passpoint-hs20)#
conn-capability protocol 17 port 161 status closed
```

Related commands [show wireless network](#)
[hs20 \(wireless-network-passpoint\)](#)

Command changes Version 5.5.0-2.3: command added

country-code

Overview Use this command to set the country code for an AP-profile.

Use the **no** variant of this command to revert back to the default country code for the device's region.

Syntax `country code <code>`
`no country code`

Parameter	Description
<code><code></code>	A two letter code representing the country. Use the command <code>show wireless country-code</code> to see the full list of country codes available.

Default The default country code is '**jp**' for Japan or '**us**' for other regions.

Mode Wireless AP Profile Configuration

Usage notes To display a list of the country codes that can be applied, use the command **show wireless country-code**

Note, applying a new country code will reset the following configuration for the **ap-profile** and **ap-radio** modes:

- mode, bandwidth, and channel

Example To set the country code to 'New Zealand' for AP-profile 10, use the following commands:

```
awplus# configure terminal
awplus(config)# wireless
awplus(config-wireless)# ap-profile 10
awplus(config-wireless-ap-prof)# country-code nz
```

Related commands [show wireless country-code](#)
[show wireless ap-profile](#)
[channel \(wireless-ap-radio\)](#)
[mode \(wireless-ap-prof-radio\)](#)
[bandwidth \(wireless-ap-prof-radio\)](#)

Command changes Version 5.4.7-2.4: command added

day (wireless-task)

Overview Use this command to set a day or range of days to run a task.

You can use the **time** command along with the **day** command to more fully set the task run time configuration.

Use the **no** variant of this command to remove the day set to run a task.

Syntax `day {<day> <month> <year>|<daysofweek>|every-day}`
`no day`

Parameter	Description
<day>	The day set for the task. Select a number from 1-31.
<month>	The month to run the task. Enter the first three letters of the month, for example Jan, Feb, Mar...
<year>	The year to run the task. Select a year between <2000-2035>.
<daysofweek>	The day or days of the week to run the task. (sunday monday tuesday wednesday thursday friday saturday)
every-day	Set the task to run on every day of the week.

Default Not set.

Mode Wireless Task Configuration

Example To configure task 5 to run on the 22nd of September 2017, use the following commands:

```
awplus# configure terminal
awplus(config)# wireless
awplus(config-wireless)# task 5
awplus(config-wireless-task)# day 22 Sep 2017
```

Related commands [task](#)
[show wireless task](#)
[time \(wireless-task\)](#)

Command changes Version 5.4.7-2.4: command added.

deauth-req-timeout (wireless-network-passpoint-hs20)

Overview Use this command to configure the deauthentication request timeout.
Use the **no** variant of this command to revert the deauthentication timeout time to the default value.

Syntax `deauth-req-timeout <0-65535>`
`no deauth-req-timeout`

Parameter	Description
<code><0-65535></code>	The timeout, in seconds, for client deauthentication after sending WNM notification frames. WNM notification requests allow the hotspot feature to send clients the URLs of servers that allow the client to access information about how to subscribe to the service, correct connection errors, or extend the current session.

Default 60 seconds.

Mode Wireless Network Passpoint Hotspot 2.0 Configuration

Example To configure a deauthentication request timeout of 120 seconds, use the commands:

```
awplus# configure terminal
awplus(config)# wireless
awplus(config-wireless)# network 1
awplus(config-wireless-network)# passpoint
awplus(config-wireless-network-passpoint)# hs20
awplus(config-wireless-network-passpoint-hs20)#
deauth-req-timeout 120
```

Related commands [show wireless network](#)
[hs20 \(wireless-network-passpoint\)](#)

Command changes Version 5.5.0-2.3: command added

debug wireless

Overview Use this command to enable wireless debugging. Debugging filters can be based on severity level and module name.

Use the **no** variant of this command to disable all wireless debugging.

Syntax

```
debug wireless level  
{all|debug|dump|error|info|notice|trace|warning}  
  
debug wireless module  
{all|apca|apmgr|apreq|clnmgr|cwmcore|rogue|syncscan}  
  
no debug wireless
```

Parameter	Description
level	Filters logging events by severity level and displays the output by one of the following configured options:
all	All level events
debug	Debug events
dump	Dump events
error	Error conditions
info	Information messages
notice	Normal, but significant conditions
trace	Trace events
warning	Warning conditions
module	Filters logging events by module name and displays the output by one of the following configured options:
all	All module events
apca	Auto power/channel assignment events
apmgr	AP manager events
apreq	HTTP AP request events
clnmgr	Client manager events
cwmcore	CWM core events
rogue	Rogue events
syncscan	Sync scan events

Default Disabled

Mode User Exec

Example To enable debugging of wireless with 'info' level on the 'apca' module, use the command:

```
awplus# debug wireless level info module apca
```

To disable debugging of wireless, use the command:

```
awplus# no debug wireless
```

Related commands [show debugging wireless](#)

Command changes Version 5.5.0-0.1: command added

description (wireless-ap)

Overview Use this command to specify a description to identify an Access Point (AP).
Use the **no** variant of this command to remove the description of a selected AP.

Syntax `description <description>`
`no description`

Parameter	Description
<code><description></code>	Text to describe a specific AP.

Default Not set.

Mode Wireless AP Configuration

Example To specify a description for an AP, use the following commands:

```
awplus# configure terminal
awplus(config)# wireless
awplus(config-wireless)# ap 10
awplus(config-wireless-ap)# description AP10_MEETING_SPACE
```

Related commands [ap](#)
[show wireless ap](#)

Command changes Version 5.4.7-2.4: command added.

description (wireless-ap-prof)

Overview Use this command to configure an AP-profile description. You must be in the **config-wireless-ap-prof** mode to use this command.

Use the **no** variant of this command to remove an AP-profile description.

Syntax `description <description>`
`no description`

Default Not set.

Mode Wireless AP Profile Configuration

Example To configure the description "PROF10" for an AP-profile, use the following commands:

```
awplus# configure terminal
awplus(config)# wireless
awplus(config-wireless)# ap-profile 10
awplus(config-wireless-ap-prof)# description PROF10
```

Related commands [ap-profile \(wireless\)](#)
[show wireless ap-profile](#)

Command changes Version 5.4.7-2.4: command added

description (wireless-mac-flt)

Overview Use this command to set the description of a wireless MAC filter.
Use the **no** variant of this command to remove the description.

Syntax `description <description>`
`no description`

Parameter	Description
<code><description></code>	Text describing the wireless MAC filter.

Default No description set by default.

Mode Wireless MAC Filter Configuration

Example To set the description of MAC filter '20' to 'mywhitelist', use the following commands:

```
awplus# configure terminal
awplus(config)# wireless
awplus(config-wireless)# wireless-mac-filter 20
awplus(config-wireless-mac-flt)# description mywhitelist
```

To remove the description from MAC filter '20', use the following commands:

```
awplus# configure terminal
awplus(config)# wireless
awplus(config-wireless)# wireless-mac-filter 20
awplus(config-wireless-mac-flt)# no description
```

Related commands

- [filter-entry](#)
- [show wireless ap-profile](#)
- [show wireless wireless-mac-filter](#)
- [wireless export](#)
- [wireless import](#)
- [wireless-mac-filter \(wireless\)](#)
- [wireless-mac-filter \(wireless-ap-prof\)](#)
- [wireless-mac-filter enable](#)

Command changes Version 5.4.8-2.1: command added

description (wireless-network)

Overview Use this command to set a description for the wireless network.
Use the **no** variant of this command to remove a description for a wireless network.

Syntax `description <description>`
`no description`

Parameter	Description
<code><description></code>	Set a description for a wireless network.

Default Not set.

Mode Wireless Network Configuration

Example To set the description for a wireless network, use the following commands:

```
awplus# configure terminal
awplus(config)# wireless
awplus(config-wireless)# network 20
awplus(config-wireless-network)# description GUEST_NETWORK
```

Related commands [network \(wireless\)](#)
[show wireless network](#)

Command changes Version 5.4.7-2.4: command added.

description (wireless-sc-prof)

Overview Use this command to configure a descriptive name for a Smart Connect profile. Use the **no** variant of this command to remove a Smart Connect profile name.

Syntax `description <sc-profile-name>`
`no description`

Parameter	Description
<code><sc-profile-name></code>	The descriptive name given to a Smart Connect profile.

Default Not set

Mode Wireless Smart Connect Profile Configuration

Example To set the descriptive name of SC-PROF10 for Smart Connect profile 10, use the commands:

```
awplus# configure terminal
awplus(config)# wireless
awplus(config-wireless)# smart-connect-profile 10
awplus(config-wireless-sc-prof)# description SC-PROF10
```

Related commands [smart-connect-profile](#)
[show wireless ap-profile](#)

Command changes Version 5.5.0-0.1: command added

description (wireless-task)

Overview Use this command to set a description for a wireless task configuration.
Use the **no** variant of this command to remove a description for a wireless task configuration.

Syntax `description <description>`
`no description`

Parameter	Description
<code><description></code>	The description for a wireless task configuration.

Default Not set.

Mode Wireless Task Configuration

Example To set a description for the wireless task 5 configuration, use the following commands:

```
awplus# configure terminal
awplus(config)# wireless
awplus(config-wireless)# task 5
awplus(config-wireless-task)# description PERIODIC_AWC_CALC
```

Related commands [task](#)
[show wireless task](#)

Command changes Version 5.4.7-2.4: command added.

description (wireless-trigger)

Overview Use this command to set a description for a wireless trigger.
Use the **no** variant of this command to delete the description for a wireless trigger.

Syntax `description <description>`
`no description`

Parameter	Description
<code><description></code>	Text to describe the wireless trigger.

Default Not set.

Mode Wireless Trigger Configuration

Example To set a description on a wireless trigger, use the commands:

```
awplus# configure terminal
awplus(config)# wireless
awplus(config-wireless)# wireless-trigger 1
awplus(config-wireless-trigger)# description TRIGGER DESC 1
```

Related commands [wireless wireless-trigger](#)
[wireless-trigger](#)
[show wireless network](#)

Command changes Version 5.5.1-0.1: command added

dgaf enable

(wireless-network-passpoint-hs20)

Overview Use this command to enable Downstream Group-Addressed Forwarding (DGAF).
Use the **no** variant of this command to disable DGAF.

Syntax dgaf enable
no dgaf enable

Default Enabled.

Mode Wireless Network Passpoint Hotspot 2.0 Configuration

Example To disable Downstream Group-Addressed Forwarding on network 1, use the commands:

```
awplus# configure terminal
awplus(config)# wireless
awplus(config-wireless)# network 1
awplus(config-wireless-network)# passpoint
awplus(config-wireless-network-passpoint)# hs20
awplus(config-wireless-network-passpoint-hs20)# no dgaf enable
```

Related commands [show wireless network](#)
[proxy-arp enable](#)
[hs20 \(wireless-network-passpoint\)](#)

Command changes Version 5.5.0-2.3: command added

domain-name (wireless-network-passpoint-dot11u)

Overview Use this command to configure one or more domain names for the entity operating the AP.

Use the **no** variant of this command to revert to the default value.

Syntax domain-name <domain-name>
no domain-name

Parameter	Description
<domain-name>	The Domain Name(s) <ul style="list-style-type: none">• Use the FQDN format, e.g. domain-name example.com• Multiple domain name entries must be separated by a comma• The length of a character in the OI-List must be less than 255 , and 10 elements or less.

Default Not set

Mode Wireless Network Passpoint 802.11u Configuration

Example To set two domain names, mydomain.com and example.net, use the commands:

```
awplus# configure terminal
awplus(config)# wireless
awplus(config-wireless)# network 1
awplus(config-wireless-network)# passpoint
awplus(config-wireless-network-passpoint)# dot11u
awplus(config-wireless-network-passpoint-dot11u)# domain-name
mydomain.com,example.net
```

Related commands [show wireless network](#)
[dot11u \(wireless-network-passpoint\)](#)

Command changes Version 5.5.0-2.3: command added

dot11u (wireless-network-passpoint)

Overview Use this command to add a new 802.11u configuration and enter the configuration mode.

Use the **no** variant of this command to revert to the default values.

Syntax dot11u
no dot11u

Default Not set.

Mode Wireless Network Passpoint Configuration

Example To enter the 802.11u configuration mode, use the commands:

```
awplus# configure terminal
awplus(config)# wireless
awplus(config-wireless)# network 1
awplus(config-wireless-network)# passpoint
awplus(config-wireless-network-passpoint)# dot11u
awplus(config-wireless-network-passpoint-dot11u)#
```

Related commands [show wireless network](#)
[hs20 \(wireless-network-passpoint\)](#)
[passpoint](#)
[network-type \(wireless-network-passpoint-dot11u\)](#)
[hessid \(wireless-network-passpoint-dot11u\)](#)

Command changes Version 5.5.0-2.3: command added

dtim-period

Overview Use this command to set the Delivery Traffic Indication Map (DTIM) period on the network configuration. A DTIM period value is a number that determines how often a beacon frame includes a Delivery Traffic Indication Message, and this number is included in each beacon frame.

Use the **no** variant of this command to reset the DTIM period to the default (1).

Syntax dtim-period <1-5>
no dtim-period

Parameter	Description
<1-5>	DTIM period in seconds. Increasing this number will increase the power saving effect, but it will slow down the response.

Default 1.

Mode Wireless Network Configuration

Usage notes The DTIM is how the AP warns its clients that it is about to transmit the multicast (and broadcast) frames it queued up since the previous DTIM.

This queueing and scheduled delivery is done to allow power-conscious devices to save power by turning off their receivers for brief stretches of time, only waking up their receivers when the AP indicates it has traffic for them.

Example To set a DTIM period of 2 seconds on network 1, use the commands:

```
awplus# configure terminal
awplus(config)# wireless
awplus(config-wireless)# network 1
awplus(config-wireless-network)# dtim-period 2
```

Related commands [show wireless network](#)
[network \(wireless\)](#)

Command changes Version 5.5.1-0.1: command added

dup-auth-received (wireless-network)

Overview Use this command to set a wireless network to accept or ignore 'Duplicate AUTH received' messages. If the message is accepted, then connected clients are disconnected.

Use the **no** variant of this command to use the default action.

Syntax dup-auth-received {disconnect|ignore}
no dup-auth-received

Parameter	Description
disconnect	Accept the disconnect connection request.
ignore	Ignore the disconnection request.

Default Disconnect.

Mode Wireless Network Configuration

Example To configure network 5 to ignore 'Duplicate AUTH received' messages, use the commands:

```
awplus# configure terminal
awplus(config)# wireless
awplus(config-wireless)# network 5
awplus(config-wireless-network)# dup-auth-received ignore
```

Related commands [network \(wireless\)](#)
[show wireless ap-profile](#)
[show wireless network](#)

Command changes Version 5.5.1-2.1: command added

dynamic-vlan enable (wireless-sec-osen)

Overview Use this command to enable the dynamic-vlan function on wireless APs using the OSEN security mode.

Use the **no** variant of this command to disable the dynamic-vlan function.

Syntax `dynamic-vlan enable`
`no dynamic-vlan enable`

Default Enabled.

Mode Wireless Security OSEN Configuration

Usage notes OSEN is a wireless security method used with Release 2 of Hotspot 2.0 (Passpoint) OSEN is short for Online Sign Up (OSU) Server-only Authenticated Layer 2 Encryption Network. Use the **security** command to enter OSEN security configuration mode.

This command is not supported by MWS series APs.

Example To disable the dynamic-vlan function for security 100, use the commands:

```
awplus# configure terminal
awplus(config)# wireless
awplus(config-wireless)# security 100 mode osen
awplus(config-wireless-sec-osen)# no dynamic-vlan enable
```

Related commands [show wireless security](#)
[security \(wireless\)](#)

Command changes Version 5.5.0-2.3: command added

enable (wireless-ap-prof-snmp)

Overview Use this command to enable an SNMP configuration for the target AP profile.
Use the **no** variant of this command to disable the SNMP configuration for the target AP profile.

Syntax enable
no enable

Default Disabled

Mode Wireless AP Profile SNMP Configuration

Example To enable SNMP, use the commands:

```
awplus# configure terminal
awplus(config)# wireless
awplus(config-wireless)# ap-profile 2
awplus(config-wireless-ap-prof)# snmp
awplus(config-wireless-ap-prof-snmp)# enable
```

To disable SNMP, use the commands:

```
awplus# configure terminal
awplus(config)# wireless
awplus(config-wireless)# ap-profile 2
awplus(config-wireless-ap-prof)# snmp
awplus(config-wireless-ap-prof-snmp)# no enable
```

Related commands

- [community read-only \(wireless-ap-prof-snmp\)](#)
- [community trap \(wireless-ap-prof-snmp\)](#)
- [permit host \(wireless-ap-prof-snmp\)](#)
- [username \(wireless-ap-prof-snmp\)](#)
- [show wireless ap-profile](#)
- [snmp \(wireless-ap-prof\)](#)
- [version \(wireless-ap-prof-snmp\)](#)

Command changes Version 5.5.0-2.1: command added

emergency-mode

Overview Use this command to set emergency mode on a wireless network. Wireless networks in emergency mode are only active when AWC is also in emergency mode. You can use emergency mode to prevent people from being isolated from infrastructure in the event of a natural disaster such as an earthquake or typhoon.

Use the **no** variant of this command to remove the emergency mode from a wireless network.

Syntax `emergency-mode`
`no emergency-mode`

Default Disabled.

Mode Wireless Network Configuration

Example To configure an emergency mode for network 5, use the commands:

```
awplus# configure terminal
awplus(config)# wireless
awplus(config-wireless)# network 5
awplus(config-wireless-network)# emergency-mode
```

Related commands

- [emergency-mode](#)
- [emergency-mode usb enable](#)
- [emergency-mode usb key](#)
- [show wireless network](#)
- [wireless emergency-mode](#)
- [wireless emergency-mode usb mark key](#)

Command changes Version 5.5.0-0.3: command added

emergency-mode usb enable

Overview Use this command to allow AlliedWare Plus to put your wireless network into Emergency Mode by inserting a pre-prepared USB stick. Emergency mode makes your wireless network available to the public in an emergency, such as a natural disaster. This feature makes it easy to start emergency mode, because you don't have to log into the AlliedWare Plus device to do so.

Use the **no** variant of this command to stop allowing the network to enter emergency mode through a pre-prepared USB stick.

Syntax `emergency-mode usb enable`
`no emergency-mode usb enable`

Default Disabled

Mode Wireless Configuration

Example To configure this feature, first create a suitable wireless network and reserve it for emergency mode only. To reserve the network, use the command [emergency-mode](#).

Then insert an empty USB stick into the AlliedWare Plus device and use the following commands:

```
awplus# configure terminal
awplus(config)# wireless
awplus(config-wireless)# emergency-mode usb enable
awplus(config-wireless)# emergency-mode usb key ExampleKey
description ExampleEmergencyUSB
awplus(config-wireless)# end
awplus# wireless emergency-mode usb mark key ExampleKey
```

The **key** parameter in the commands [emergency-mode usb key](#) and [wireless emergency-mode usb mark key](#) must match.

After this, to put the network into emergency mode, just insert the USB stick. As long as the keys on the device and the stick match, emergency mode will automatically activate. The device's port LEDs will blink to indicate it is in emergency mode.

Related commands [emergency-mode](#)
[emergency-mode usb key](#)
[show wireless](#)
[wireless emergency-mode usb mark key](#)

Command changes Version 5.5.2-1.1: command added

emergency-mode usb key

Overview Use this command to enter a key for putting your wireless network into Emergency Mode by inserting a pre-prepared USB stick. If someone inserts a USB stick into the device, the device will look to see if the USB stick also contains this key. If it does, then the device will put the network into emergency mode.

You can enter up to 10 keys, to allow you to have multiple pre-prepared USB sticks.

Along with this command, use [wireless emergency-mode usb mark key](#) to prepare the USB stick and put the same key on it.

Use the **no** variant of this command to remove a key.

Syntax `emergency-mode usb key <key> [description <description>]`
`no emergency-mode usb key <key>`

Parameter	Description
<code>key <key></code>	The key, which can be up to 32 characters long. You can use any printable ASCII characters. If you use spaces or symbols, enclose the key in quote marks, for example "Example Key1".
<code>description <description></code>	An optional description of this key, up to 64 characters long. You can use any printable ASCII characters.

Default No keys exist

Mode Wireless Configuration

Example To configure this feature, first create a suitable wireless network and reserve it for emergency mode only. To reserve the network, use the command [emergency-mode](#).

Then insert an empty USB stick into the AlliedWare Plus device and use the following commands:

```
awplus# configure terminal
awplus(config)# wireless
awplus(config-wireless)# emergency-mode usb enable
awplus(config-wireless)# emergency-mode usb key ExampleKey
description ExampleEmergencyUSB
awplus(config-wireless)# end
awplus# wireless emergency-mode usb mark key ExampleKey
```

The **key** parameter in the commands [emergency-mode usb key](#) and [wireless emergency-mode usb mark key](#) must match.

After this, to put the network into emergency mode, just insert the USB stick. As long as the keys on the device and the stick match, emergency mode will

automatically activate. The device's port LEDs will blink to indicate it is in emergency mode.

**Related
commands**

[emergency-mode](#)
[emergency-mode usb enable](#)
[show wireless](#)
[wireless emergency-mode usb mark key](#)

**Command
changes**

Version 5.5.2-1.1: command added

emergency-service-reachable enable (wireless-network-passpoint-dot11u)

Overview Use this command to configure Emergency Services Reachable.
Use the **no** variant of this command to disable Emergency Services Reachable.

Syntax `emergency-service-reachable enable`
`no emergency-service-reachable enable`

Default Disabled.

Mode Wireless Network Passpoint 802.11u Configuration

Example To enable Emergency Services Reachable, use the commands:

```
awplus# configure terminal
awplus(config)# wireless
awplus(config-wireless)# network 1
awplus(config-wireless-network)# passpoint
awplus(config-wireless-network-passpoint)# dot11u
awplus(config-wireless-network-passpoint-dot11u)#
emergency-service-reachable enable
```

Related commands [show wireless network](#)
[dot11u \(wireless-network-passpoint\)](#)

Command changes Version 5.5.0-2.3: command added

enable (wireless)

Overview Use this command to enable Access Point (AP) management by Autonomous Wave Control (AWC).

Use the **no** variant of this command to disable AP management by AWC.

Syntax enable
no enable

Default Disabled.

Mode Wireless Configuration

Usage notes You must use the **enable** command before you configure a management address.

Example To configure AP management by AWC, using an interface with the IP address 192.168.0.1, use the following commands:

```
awplus# configure terminal
awplus(config)# wireless
awplus(config-wireless)# enable
awplus(config-wireless)# management address 192.168.0.1
```

Related commands [management address](#)
[show wireless](#)

Command changes Version 5.4.7-2.4: command added.

enable (wireless-ap)

Overview Use this command to enable a wireless Access Point (AP) configuration.
Use the **no** variant of this command to disable wireless AP configuration.

Syntax enable
no enable

Default Disabled.

Mode Wireless AP Configuration

Example To enable the configuration for AP 100, use the following commands:

```
awplus# configure terminal
awplus(config)# wireless
awplus(config-wireless)#ap 100
awplus(config-wireless-ap)#enable
```

Related commands [ap](#)
[show wireless ap](#)

Command changes Version 5.4.7-2.4: command added.

enable (wireless-ap-prof-radio)

Overview Use this command to enable a wireless Access Point (AP) profile radio configuration.

Use the **no** variant of this command to disable a wireless AP profile radio configuration.

Syntax enable
no enable

Default Disabled.

Mode Wireless AP Profile Radio Configuration

Example To enable an AP radio profile configuration, use the following commands:

```
awplus# configure terminal
awplus(config)# wireless
awplus(config-wireless)# ap-profile 100
awplus(config-wireless-ap-prof)# radio 1
awplus(config-wireless-ap-prof-radio)# enable
```

Related commands [radio \(wireless-ap-profile\)](#)

Command changes Version 5.4.7-2.4: command added

enable (wireless-network-cp)

Overview Use this command to enable Captive Portal (web authentication) configuration on the target network.

Use the **no** variant of this command to disable Captive Portal configuration on the target network.

Syntax enable
no enable

Default Disabled

Mode Wireless Network Configuration

Example To enable Captive Portal, use the commands:

```
awplus# configure terminal
awplus(config)# wireless
awplus(config-wireless)# network 20
awplus(config-wireless-network)# captive-portal
awplus(config-wireless-network-cp)# enable
```

Related commands [captive-portal](#)
[enable \(wireless-network-cp\)](#)
[page-proxy-url](#)
[radius auth group \(wireless-network-cp\)](#)
[redirect-url](#)
[session-keep](#)
[mode \(wireless-network-cp\)](#)

Command changes Version 5.4.9-1.1: command added

enable (wireless-network-passpoint)

Overview Use this command to enable Passpoint.
Use the **no** variant of this command to disable Passpoint.

Syntax enable
no enable

Default Disabled

Mode Wireless Network Passpoint Configuration

Example To enable Passpoint for network 20, use the commands:

```
awplus# configure terminal
awplus(config)# wireless
awplus(config-wireless)# network 20
awplus(config-wireless-network)# passpoint
awplus(config-wireless-network-passpoint)# enable
```

Related commands [passpoint](#)

Command changes Version 5.5.0-2.3: command added

enable (wireless-sec-wep)

Overview Use this command to enable a wireless WEP security configuration.
Use the **no** variant of this command to disable a wireless WEP security configuration.

Syntax enable
no enable

Default Disabled.

Mode Wireless Security WEP Configuration

Example To enable a wireless security WEP configuration, use the following commands:

```
awplus# configure terminal
awplus(config)# wireless
awplus(config-wireless)# network 10 mode wep
awplus(config-wireless-sec-wep)# enable
```

Related commands [security \(wireless\)](#)

Command changes Version 5.4.7-2.4: command added.

enable (wireless-task)

Overview Use this command to enable a wireless task configuration.
Use the **no** variant of this command to disable a wireless task configuration.

Syntax enable
no enable

Default Not set.

Mode Wireless Task Configuration

Example To enable the wireless task 5 configuration, use the following commands:

```
awplus# configure terminal
awplus(config)# wireless
awplus(config-wireless)# task 5
awplus(config-wireless-task)# enable
```

Related commands [task](#)
[show wireless task](#)

Command changes Version 5.4.7-2.4: command added.

enable (wireless-wds)

Overview Use this command to enable a wireless WDS security configuration.
Use the **no** variant of this command to disable a wireless WDS security configuration.

Syntax enable
no enable

Default Not set.

Mode Wireless WDS Configuration

Example To enable a wireless WDS configuration, use the following commands:

```
awplus# configure terminal
awplus(config)# wireless
awplus(config-wireless)# wds 10
awplus(config-wireless-wds)# enable
```

Related commands [wds](#)
[show wireless wds](#)

Command changes Version 5.4.7-2.4 command added.

external-page-url

Overview Use this command to configure the external URL authentication page for Captive Portal.

To use this command, you must first specify external-page-redirect using the **mode** command.

Use the **no** variant of this command to reset the external authentication page URL.

Syntax external-page-url <URL>
no external-page-url

Parameter	Description
<URL>	URL of the external authentication page

Default Disabled

Mode Wireless Network Captive Portal Configuration

Example To enable and set URL string 'http://www.example.com' for a Captive Portal external web authentication server on network 20, use the commands:

```
awplus# configure terminal
awplus(config)# wireless
awplus(config-wireless)# network 20
awplus(config-wireless-network)# captive-portal
awplus(config-wireless-network-cp)# external-page-url
http://www.example.com
```

Related commands [captive-portal virtual-ip](#)
[mode \(wireless-network-cp\)](#)
[radius auth group \(wireless-network-cp\)](#)
[show wireless network](#)

Command changes Version 5.5.0-1.3: command added

filter-entry

Overview Use this command to add a filter entry to a wireless MAC filter. You can optionally include a description for the filter.

Use the **no** variant of this command to remove an entry from the MAC filter list.

Syntax `filter-entry <mac-address> [description <description>]`
`no filter-entry <mac-address>`

Parameter	Description
<code><mac-address></code>	MAC address of the filter entry in hexadecimal format HHHH.HHHH.HHHH. You can add up to 3072 MAC addresses per MAC filter, depending on your AP model.
<code>description</code>	Set an optional description for the filter entry.
<code><description></code>	Text describing the filter entry.

Default No filter entries exist

Mode Wireless MAC Filter Configuration

Usage notes If you need to add a large number of filter entries, you can use the Device GUI instead of this command. The GUI lets you upload the entries as a CSV file.

Example To add a filter entry to the MAC filter numbered 20, use the commands:

```
awplus# configure terminal
awplus(config)# wireless
awplus(config-wireless)# wireless-mac-filter 20
awplus(config-wireless-mac-flt)# filter-entry
0000.cd28.0880.1234 description PC01
```

To remove a filter entry from the MAC filter numbered 20, use the commands:

```
awplus# configure terminal
awplus(config)# wireless
awplus(config-wireless)# wireless-mac-filter 20
awplus(config-wireless-mac-flt)# no filter-entry
0000.cd28.0880.1234
```

Related commands

- [description \(wireless-mac-flt\)](#)
- [show wireless ap-profile](#)
- [show wireless wireless-mac-filter](#)
- [wireless export](#)

wireless import

wireless-mac-filter (wireless)

wireless-mac-filter (wireless-ap-prof)

wireless-mac-filter enable

**Command
changes**

Version 5.5.2-1.1: maximum entries per filter increased for some APs

Version 5.4.8-2.1: command added

force-disable (wireless-ap-radio)

Overview Use this command to override and force the disabling of an Access Point (AP) radio status.

Use the **no** variant of this command to stop overrides of an AP radio status.

Syntax `force-disable`
`no force-disable`

Default **no force-disable** (do not override the AP profile radio status).

Mode Wireless AP Radio Configuration

Example To force a disable of an AP radio status, use the following commands:

```
awplus# configure terminal
awplus(config)# wireless
awplus(config-wireless)# ap 100
awplus(config-wireless-ap)# radio 2
awplus(config-wireless-ap-radio)# force-disable
```

Related commands [show wireless ap-profile](#)
[radio \(wireless-ap-profile\)](#)

Command changes Version 5.4.7-2.4: command added

gas-address-behavior (wireless-network-passpoint-dot11u)

Overview Use this command to set the GAS (Generic Advertisement Services) Address 3 behavior for 802.11u.

Use the **no** variant of this command to revert to the default value.

Syntax `gas-address-behavior <0-2>`
`no gas-address-behavior`

Parameter	Description
<0-2>	<p>GAS Address 3 behavior.</p> <ul style="list-style-type: none">• 0: P2P specification (Address3 = AP BSSID) workaround enabled by default based on GAS request Address3.• 1: IEEE 802.11 standard compliant regardless of GAS request Address3• 2: Force non-compliant behavior (Address3 = AP BSSID for all cases)

Default 0.

Mode Wireless Network Passpoint 802.11u Configuration

Example To configure the GAS Address 3 behavior value to 1, use the commands:

```
awplus# configure terminal
awplus(config)# wireless
awplus(config-wireless)# network 1
awplus(config-wireless-network)# passpoint
awplus(config-wireless-network-passpoint)# dot11u
awplus(config-wireless-network-passpoint-dot11u)#
gas-address-behavior 1
```

Related commands [show wireless network](#)
[dot11u \(wireless-network-passpoint\)](#)

Command changes Version 5.5.0-2.3: command added

gas-comeback-delay (wireless-network-passpoint-dot11u)

Overview Use this command to set the generic advertisement service (GAS) comeback-delay for 802.11u.

Use the **no** variant of this command to revert to the default value.

Syntax `gas-comeback-delay <0-65535>`
`no gas-comeback-delay <0-65535>`

Parameter	Description
<code><0-65535></code>	GAS comeback delay Time Unit (TU) 1 TU = 1024 microseconds (approx 1 millisecond)

Default 0.

Mode Wireless Network Passpoint 802.11u Configuration

Example To configure the GAS comeback-delay value to 100, use the commands:

```
awplus# configure terminal
awplus(config)# wireless
awplus(config-wireless)# network 1
awplus(config-wireless-network)# passpoint
awplus(config-wireless-network-passpoint)# dot11u
awplus(config-wireless-network-passpoint-dot11u)#
gas-comeback-delay 100
```

Related commands [show wireless network](#)
[dot11u \(wireless-network-passpoint\)](#)

Command changes Version 5.5.0-2.3: command added

hessid

(wireless-network-passpoint-dot11u)

Overview Use this command to set the HESSID (Homogeneous Extended Service Set Identifier).

Use the **no** variant of this command to revert to the default value.

Syntax hessid MAC
no hessid

Parameter	Description
MAC	Homogeneous ESS Identifier, in Hexidecimal notation and MAC address format: HHHH.HHHH.HHHH.HHHH

Default Not set.

Mode Wireless Network Passpoint 802.11u Configuration

Usage notes In typical Wi-Fi deployments, if two APs have different SSIDs, they are considered to be in different wireless networks.

If two APs have the same SSID, they are considered to be part of the same wireless network. But because SSIDs are not globally administered, it is possible that two APs with the same SSID are, in fact, in different wireless networks.

The homogeneous extended service set identifier (HESSID) element allows mobile devices to detect this condition. When two APs have the same SSID but from different wireless networks, the two networks have different HESSIDs

Example To set the Homogeneous ESS Identifier '02AA.BBCC.1122', use the commands:

```
awplus# configure terminal
awplus(config)# wireless
awplus(config-wireless)# network 1
awplus(config-wireless-network)# passpoint
awplus(config-wireless-network-passpoint)# dot11u
awplus(config-wireless-network-passpoint-dot11u)# hssid
02AA.BBCC.1122
```

Related commands [show wireless network](#)
[dot11u \(wireless-network-passpoint\)](#)

Command changes Version 5.5.0-2.3: command added

hide-ssid (wireless-network)

Overview Use this command to hide the SSID for a selected wireless network.
Use the **no** variant of this command to stop hiding the SSID for a selected wireless network.

Syntax `hide ssid`
`no hide ssid`

Default The default is Disabled, which means the SSID **is** included in the Access Point (AP) beacon frames. For more information, see the **Usage** section below.

Mode Wireless Network Configuration

Usage notes The SSID differentiates one wireless network from another, so all APs and all devices attempting to connect to a specific wireless network must use the same SSID to enable effective roaming.

SSIDs are included in beacon frames.

A beacon frame is one of the management frames in the IEEE 802.11 standard. Every compliant AP periodically sends beacon frames to advertise the presence of an AP in an area, its capabilities, and some configuration and security information to the client devices.

Example To hide the SSID for network 20, use the following commands:

```
awplus# configure terminal
awplus(config)# wireless
awplus(config-wireless)# network 20
awplus(config-wireless-network)# hide-ssid
```

Related commands [ssid \(wireless-network\)](#)
[network \(wireless\)](#)

Command changes Version 5.4.7-2.4: command added.

hs20 (wireless-network-passpoint)

Overview Use this command to add a new Hotspot 2.0 configuration and enter the configuration mode.

Use the **no** variant of this command to revert to the default.

Syntax hs20
no hs20

Default Not set.

Mode Wireless Network Passpoint Configuration

Example To enter Hotspot 2.0 configuration mode on network 1, use the commands:

```
awplus# configure terminal
awplus(config)# wireless
awplus(config-wireless)# network 1
awplus(config-wireless-network)# passpoint
awplus(config-wireless-network-passpoint)# hs20
awplus(config-wireless-network-passpoint-hs20)#
```

Related commands show wireless network
passpoint

dgaf enable (wireless-network-passpoint-hs20)

l2tif enable (wireless-network-passpoint-hs20)

operator (wireless-network-passpoint-hs20)

anqp-domain-id (wireless-network-passpoint-hs20)

deauth-req-timeout (wireless-network-passpoint-hs20)

operating-class (wireless-network-passpoint-hs20)

Command changes Version 5.5.0-2.3: command added

hwtype

Overview Use this command to configure the hardware type used for a wireless AP profile. Use the **no** variant of this command to revert the AP hardware type to the default.

Syntax `hwtype <modelname>`
`hwtype tq {single|dual|triple} spec {11ac|11n}`
`no hwtype`

Parameter	Description
<code><modelname></code>	Set the model name. See the table below for a list of model names and associated settings.
<code>tq</code>	The hardware type used for the AT-TQ series
<code>mws</code>	The hardware type used for the AT-MWS series
<code>single</code>	Single antenna model. Only available for the AT-TQ series.
<code>dual</code>	Dual antenna model.
<code>spec</code>	Enable selection of support mode of the hardware type
<code>11ac</code>	Support for 802.11ac mode.
<code>11n</code>	Support for 802.11n mode.

Table 1: AP `modelname` parameters with applicable values

AP	modelname parameter	series	bands supported	standard supported
TQ6602 GEN2, TQm6602 GEN2, TQ6702 GEN2, TQm6702 GEN2	at-tq6602gen2 at-tqm6602gen2 at-tq6702gen2 at-tqm6702gen2	tq	dual	11ax
TQ6602	at-tq6602	tq	dual	11ax
TQ5403, TQm5403, TQ5403e	at-tq5403 at-tqm5403 at-tq5403e	tq	triple	11ac
TQ4400, TQ4400e, TQ4600, TQ1402, TQm1402	at-tq4400 at-tq4400e at-tq4600 at-tq1402 at-tqm1402	tq	dual	11ac
TQ2450, TQ3400, TQ3600	at-tq2450 at-tq3400 at-tq3600	tq	dual	11n
TQ3200	at-tq3200	tq	single	11n

Table 1: AP *modelname* parameters with applicable values (cont.)

AP	modelname parameter	series	bands supported	standard supported
MWS1750AP, MWS2533AP	at-mws1750ap at-mws2533ap	mws	dual	11ac
MSW600AP	at-mws600ap	mws	dual	11n

Default hwtype tq dual spec 11ac

Mode Wireless AP Profile Configuration

Usage notes This command may reset the following configuration commands for:

- antenna (AP profile)
- mode
- bandwidth
- channel

Example To configure the AP hardware type as an AT-TQ5403 (TQ series, triple antenna, supported by 802.11ac), use the following commands:

```
awplus# configure terminal
awplus(config)# wireless
awplus(config-wireless)# ap-profile 2
awplus(config-wireless-ap-prof)# hwtype tq triple 11ac
```

To use the *<modelname>* parameter to configure the AP hardware type as an AT-TQ5403 (TQ series, triple antenna, supported by 802.11ac), use the following commands:

```
awplus# configure terminal
awplus(config)# wireless
awplus(config-wireless)# ap-profile 2
awplus(config-wireless-ap-prof)# hwtype at-tq5403
```

Related commands

- [ap-profile \(wireless\)](#)
- [show wireless ap-profile](#)
- [show wireless ap capability](#)
- [channel \(wireless-ap-radio\)](#)
- [antenna \(wireless-ap-prof-radio\)](#)
- [bandwidth \(wireless-ap-prof-radio\)](#)
- [channels \(wireless-ap-prof-radio\)](#)

Command changes

- Version 5.4.7-2.4: command added
- Version 5.4.9-1.1: *<modelname>* parameter added.

index

Overview Use this command to designate the key index number for WEP security.
Use the **no** variant of this command to use the default key index number for WEP security.

Syntax `index <1-4>`
`no index`

Parameter	Description
<1-4>	The index number for the WEP security key.

Default The default key index number is set to **1**.

Mode Wireless Security WEP Configuration

Example To assign key index number 3 for a WEP security configuration, use the following commands:

```
awplus# configure terminal
awplus(config)# wireless
awplus(config-wireless)# network 10 mode wep
awplus(config-wireless-sec-wep)# index 3
```

Related commands [security \(wireless\)](#)
[key \(wireless-sec-wep\)](#)

Command changes Version 5.4.7-2.4: command added.

initialization-button enable

Overview Use this command to enable the initialization button on a wireless AP using the selected AP profile.

Use the **no** variant of this command to disable the initialization button on a wireless AP using the selected AP profile.

Syntax `initialization-button enable`
`no initialization-button enable`

Default Enabled.

Mode Wireless AP Profile Configuration

Usage notes This command effects only APs which have an initialization button.

Example To enable the initialization button on APs which use **ap-profile 100**, use the following commands:

```
awplus# configure terminal
awplus(config)# wireless
awplus(config-wireless)# ap-profile 100
awplus(config-wireless-ap-prof)# initialization-button enable
```

Related commands [ap-profile \(wireless\)](#)
[show wireless ap-profile](#)

Command changes Version 5.4.7-2.4: command added.

internet-access enable (wireless-network-passpoint-dot11u)

Overview Use this command to enable Internet access. This informs the mobile device whether Internet access is available at a hotspot – which might not be the case in walled-garden environments, where the Hotspot Operator (for example, an hotel) may limit Wi-Fi access to locally available content.

Use the **no** variant of this command to disable Internet access.

Syntax `internet-access enable`
`no internet-access enable`

Default Disabled.

Mode Wireless Network Passpoint 802.11u Configuration

Example To configure Internet access, use the commands:

```
awplus# configure terminal
awplus(config)# wireless
awplus(config-wireless)# network 1
awplus(config-wireless-network)# passpoint
awplus(config-wireless-network-passpoint)# dot11u
awplus(config-wireless-network-passpoint-dot11u)#
internet-access enable
```

Related commands [show wireless network](#)
[dot11u \(wireless-network-passpoint\)](#)

Command changes Version 5.5.0-2.3: command added

ip-addr-type-availability (wireless-network-passpoint-dot11u)

Overview Use this command to set the IPv4 and IPv6 Address Type Availability for 802.11u.

This is information about the IP address version and type that the Hotspot Operator uses and that would be allocated and available to a mobile device after it authenticates to the network.

Use the **no** variant of this command to reset the IPv4 and IPv6 Address Type Availability to their default value.

Syntax ip-addr-type-availability
{no-exist|public|port-restrict|private-nat1|private-nat2|port-private-nat1|port-private-nat2|unknown} ipv4
{no-exist|exist|unknown}
no ip-addr-type-availability

Parameter	Description
no-exist (ipv4)	Not exist IPv4.
public (ipv4)	Public IPv4.
port-restrict (ipv4)	IPv4 with port restrictions.
private-nat1 (ipv4)	Private IPv4 address with Network Address Translation (NAT) once.
private-nat2 (ipv4)	Private IPv4 address with Network Address Translation (NAT) twice.
port-private-nat1 (ipv4)	Private IPv4 with port restrictions and Network Address Translation (NAT) once.
port-private-nat2 (ipv4)	Private IPv4 with port restrictions and Network Address Translation (NAT) twice.
unknown (ipv4)	Availability unknown IPv4
no-exist (ipv6)	Not exist IPv6
exist (ipv6)	Exist IPv6
unknown (ipv6)	Availability unknown IPv6

Default IPv4: port-private-nat1.

IPv6: no-exist

Mode Wireless Network Passpoint 802.11u Configuration

Example To configure the IPv4 Address Type Availability to public and the IPv6 to no-exist, use the commands:

```
awplus# configure terminal
awplus(config)# wireless
awplus(config-wireless)# network 1
awplus(config-wireless-network)# passpoint
awplus(config-wireless-network-passpoint)# dot11u
awplus(config-wireless-network-passpoint-dot11u)#
ip-addr-type-availability public ipv6 no-exist
```

Related commands [show wireless network](#)
[dot11u \(wireless-network-passpoint\)](#)

Command changes Version 5.5.0-2.3: command added

ip-address (wireless-ap)

Overview Use this command to specify the IP address of a wireless Access Point (AP).
Use the **no** variant of this command to remove the IP address of the selected wireless AP.

Syntax `ip-address <ip-address>`
`no ip-address`

Parameter	Description
<code><ip-address></code>	IPv4 address of the wireless AP.

Default Not set.

Mode Wireless AP Configuration

Example To specify an IPv4 address for a wireless AP, use the following commands:

```
awplus# configure terminal
awplus(config)# wireless
awplus(config-wireless)# ap 100
awplus(config-wireless-ap)# ip address 192.168.0.100
```

Related commands [ap](#)
[show wireless ap](#)

Command changes Version 5.4.7-2.4: command added.

key (wireless-sc-prof)

Overview Use this command to set the Smart Connect profile security key.
Use the **no** variant of this command to remove the security key from the Smart Connect profile.

Syntax `key <key-word>`
`no key`

Parameter	Description
<code><key-word></code>	The WPA shared key. This is an alphanumeric string 8-64 characters long.

Default Not set

Mode Wireless Smart Connect Profile Configuration

Usage notes This command configures the WPA shared key for the Smart Connect network. If no key is set, the security key will be automatically generated.

Example To set the security key for Smart Connect profile 10 to 'sc10-secret-keyword', use the commands:

```
awplus# configure terminal
awplus(config)# wireless
awplus(config-wireless)# smart-connect-profile 10
awplus(config-wireless-sc-prof)# key sc10-secret-keyword
```

Related commands [smart-connect-profile](#)
[show wireless ap-profile](#)

Command changes Version 5.5.0-0.1: command added

key (wireless-sec-wep)

Overview Use this command to set the key-string for a WEP security configuration. Use the **no** variant of this command to remove a key-string for a WEP security configuration.

Syntax `key <1-4> [encrypted] <key-string>`
`no key <1-4>`

Parameter	Description
<1-4>	The key's index number. To configure the index number(s), use the index command.
encrypted	This parameter is displayed in show running-config output to indicate that it is displaying the password in encrypted form. You should not enter encrypted on the CLI yourself.
<key-string>	The usable key-string characters, which depend on the key-string type. Use the type command to configure the key-string character type. See the table in the usage section below for more information.

Default Not set.

Mode Wireless Security WEP Configuration

Usage notes When using the **key** command, also use the **type** command to set the key-string type to either ASCII or Hex, this will also set the character and bit number limits as follows.

Type	Number of bits	Number of characters	Case sensitive
ascii	64	5	Yes
ascii	128	13	Yes
hex	64	10	No
hex	128	26	No

Example To assign the word 'friend' as the key-string at index 3 for a WEP security configuration, use the following commands:

```
awplus# configure terminal
awplus(config)# wireless
awplus(config-wireless)# security 10 mode wep
awplus(config-wireless-sec-wep)# type ascii
awplus(config-wireless-sec-wep)# key 3 friend
```

Related commands [type \(wireless-sec-wep\)](#)
[length \(wireless-sec-wep\)](#)
[index](#)

Command changes Version 5.4.7-2.4: command added.

key (wireless-sec-wpa-psnl)

Overview Use this command to set a string as the shared secret key on a wireless security WPA-personal configuration.

Use the **no** variant of this command to reset the shared key to the default.

Syntax key [encrypted] <key-string>
no key

Parameter	Description
encrypted	This parameter is displayed in show running-config output to indicate that it is displaying the password in encrypted form. You should not enter encrypted on the CLI yourself.
<key-string>	The usable key-string characters for the configuration. You can enter 8 to 63 ASCII characters which are case-sensitive.

Default Not set.

Mode Wireless Security WPA-personal Configuration

Example To set **friend** as the shared secret key for a WPA-personal configuration, use the following commands:

```
awplus# configure terminal
awplus(config)# wireless
awplus(config-wireless)# security 110 mode wpa-personal
awplus(config-wireless-sec-wpa-psnl)# key friend
```

Related commands [security \(wireless\)](#)

Command changes Version 5.4.7-2.4: command added.

l2tif enable (wireless-network-passpoint-hs20)

Overview Use this command to enable Layer 2 Traffic Inspection and Filtering (l2tif).
Use the **no** variant of this command to disable Layer 2 Traffic Inspection and Filtering.

Syntax l2tif enable
no l2tif enable

Default Disabled.

Mode Wireless Network Passpoint Hotspot 2.0 Configuration

Example To enable Layer 2 Traffic Inspection and Filtering on network 1, use the commands:

```
awplus# configure terminal
awplus(config)# wireless
awplus(config-wireless)# network 1
awplus(config-wireless-network)# passpoint
awplus(config-wireless-network-passpoint)# hs20
awplus(config-wireless-network-passpoint-hs20)# l2tif enable
```

Related commands [show wireless network](#)
[hs20 \(wireless-network-passpoint\)](#)

Command changes Version 5.5.0-2.3: command added

led enable

Overview Use this command to turn on the LED of a wireless AP using the selected AP profile.

Use the **no** variant of this command to disable the LED of a wireless AP using the selected AP profile.

Syntax led enable
no led enable

Default Enabled.

Mode Wireless AP Profile Configuration

Example To turn off the LED of a wireless AP using ap-profile 100, use the following commands:

```
awplus# configure terminal
awplus(config)# wireless
awplus(config-wireless)# ap-profile 100
awplus(config-wireless-ap-prof)# no led enable
```

Related commands [ap-profile \(wireless\)](#)
[show wireless ap-profile](#)

Command changes Version 5.4.7-2.4: command added

legacy-rates

Overview Use this command to set the legacy rates on the AP profile radio configuration. Use the **no** variant of this command to delete any configured fixed legacy rates and return to the default.

Syntax legacy-rates {all|<rates>}
no legacy-rates

Parameter	Description
all	All available rate candidates are set for the specified radio.
<rates>	Multiple usable rate candidates can be set on the specified radio, separated by commas. For 2.4 GHz radios: <ul style="list-style-type: none">Select from: 54, 48, 36, 24, 18, 12, 11, 9, 6, 5.5, 2, 1.If the bandwidth is 20MHz, one of 1, 2, 5.5, 11 must be specified.If the bandwidth is 40MHz, then 1 must be specified For 5 GHz radios: <ul style="list-style-type: none">Select from: 54, 48, 36, 24, 18, 12, 9, 6. Regardless of bandwidth, one of 6, 12, 24 must be specified.

Default All.

Mode Wireless AP Profile Radio Configuration

Example To set specific legacy rates to an AP profile radio configuration, use the commands:

```
awplus# configure terminal
awplus(config)# wireless
awplus(config-wireless)# ap-profile 1
awplus(config-wireless-ap-prof)# radio 1
awplus(config-wireless-ap-prof-radio)# legacy-rates
54, 48, 5.5, 2, 1
```

Related commands [hwtype](#)
[show wireless ap-profile](#)
[legacy-rates](#)
[radio \(wireless-ap-profile\)](#)
[bandwidth \(wireless-ap-prof-radio\)](#)

Command changes Version 5.5.1-0.1: command added

length (wireless-sec-wep)

Overview Use this command to set the key length for a WEP key on a wireless security WEP configuration.

Use the **no** variant of this command to reset the key length for a WEP key to the default value.

Syntax length {64|128}
no length

Parameter	Description
64	Set 64 bit as the key length for a WEP key
128	Set 128 bit as the key length for a WEP key

Default 128 bit.

Mode Wireless Security WEP Configuration

Example To configure 64 bit length as the key length for a WEP key on a wireless security WEP configuration, use the following commands:

```
awplus# configure terminal
awplus(config)# wireless
awplus(config-wireless)# network 10 mode wep
awplus(config-wireless-sec-wep)# length 64
```

Related commands [security \(wireless\)](#)
[key \(wireless-sec-wep\)](#)

Command changes Version 5.4.7-2.4: command added.

log enable destination

Overview Use this command to enable the external media function storing of wireless client and neighbor AP log files.

Use the **no** variant of this command to disable the external media function storing of wireless client and neighbor AP log files.

Syntax `log enable destination {usb|card}`
`no log enable`

Parameter	Description
usb	USB storage device
card	SD card storage device

Default Disabled, there is no destination storage device set as a default.

Mode Wireless Configuration

Example To enable the log function and configure the log store destination to USB, use the commands:

```
awplus# configure terminal
awplus(config)# wireless
awplus(config-wireless)# log enable destination usb
```

Related commands [log size wireless-client](#)
[log rotate wireless-client](#)
[log interval neighbor-ap](#)
[show wireless](#)

Command changes Version 5.4.9-2.3: command added

log interval neighbor-ap

Overview Use this command to configure the interval times for storing a neighbor AP log. Use the **no** variant of this command to revert to the default interval time of 30 minutes.

Syntax `log interval neighbor-ap <30-1440>`
`no log interval`

Parameter	Description
<code><30-1440></code>	The interval time between storing neighbor AP logs. Enter a number in the range of 30 (min) -1440 (1 day).

Default 30 minutes

Mode Wireless Configuration

Example To configure a 60 minute interval time for storing neighbor AP logs, use the commands:

```
awplus# configure terminal
awplus(config)# wireless
awplus(config-wireless)# log interval neighbor-ap 60
```

Related commands [log enable destination](#)
[log rotate neighbor-ap](#)
[show wireless](#)

Command changes Version 5.4.9-2.3: command added

log rotate neighbor-ap

Overview Use this command to configure the number of rotations for storing neighbor AP log files. When the configured value is reached, the oldest log file is deleted and the latest log file is stored.

Use the **no** variant of this command to revert to the default value of 1.

Syntax `log rotate neighbor-ap <0-65534>`
`no log rotate neighbor-ap`

Parameter	Description
<0-65534>	The number of rotations a neighbor AP log is stored for, before deleting the oldest stored file.

Default 1

Mode Wireless Configuration

Example To configure 100 generations of a neighbor's AP log files to be stored, use the commands:

```
awplus# configure terminal
awplus(config)# wireless
awplus(config-wireless)# log rotate neighbor-ap 100
```

Related commands [log enable destination](#)
[log interval neighbor-ap](#)
[show wireless](#)

Command changes Version 5.4.9-2.3: command added

log rotate wireless-client

Overview Use this command to configure the number of rotations for storing wireless client log files.

You can determine the size of each wireless client log by using this command and the **log size wireless-client** command together.

For example, log size wireless-client 50, log rotate wireless-client 4 -> $50 / (4+1) = 10$ Kbytes.

Use the **no** variant of this command to revert to the default value of 1.

Syntax `log rotate wireless-client <0-255>`
`no log rotate wireless-client`

Parameter	Description
<0-255>	The number of rotations for a wireless-client log. Set a number in the range 0-255.

Default The default number of rotations is 1.

Mode Wireless Configuration

Example To configure 10 generations of a wireless-client log file, use the commands:

```
awplus# configure terminal
awplus(config)# wireless
awplus(config-wireless)# log rotate wireless-client 10
```

Related commands [log enable destination](#)
[log size wireless-client](#)
[show wireless](#)

Command changes Version 5.4.9-2.3: command added

log size wireless-client

Overview Use this command to configure the file size used for storing wireless client logs. You can determine the size of each wireless client log by using this command and the **log rotate wireless-client** commands together. For example, log size wireless-client 50, log rotate wireless-client 4 -> $50 / (4+1) = 10$ Kbytes. Use the **no** variant of this command to revert to the default log size value.

Syntax log size wireless-client <50-4194304>
no log size wireless-client

Parameter	Description
<50-4194304>	Wireless client log size in kilobytes

Default 50 kilobytes.

Mode Wireless Configuration

Example To configure a wireless-client log size of 1Mbyte, use the commands:

```
awplus# configure terminal
awplus(config)# wireless
awplus(config-wireless)# log size wireless-client 1000000
```

Related commands [log enable destination](#)
[log rotate wireless-client](#)
[show wireless](#)

Command changes Version 5.4.9-2.3: command added

login username (wireless-ap)

Overview Use this command to specify a username and password for a wireless Access Point (AP).

Use the **no** variant of this command to remove a username and password for a wireless AP.

Syntax login username *<username>* password *<password>*
no login username

Parameter	Description
<i><username></i>	The username for the selected AP. The first character of the AP username must be a letter.
<i><password></i>	An alphanumeric string of characters used as the password for the selected AP.

Default Not set

Mode Wireless AP Configuration

Example To set the username **manager** and password **friend** for a wireless AP, use the following commands:

```
awplus# configure terminal
awplus(config)# wireless
awplus(config-wireless)# ap 100
awplus(config-wireless-ap)# login username manager password friend
```

Related commands [ap](#)
[show wireless ap](#)

Command changes Version 5.4.7-2.4: command added.

login-password (wireless-ap)

Overview Use this command to set the login password for an Access Point (AP).
Use the **no** variant of this command to remove the login password for an AP.

Syntax login-password <password>
no login-password

Parameter	Description
<password>	An alphanumeric string of characters used as the password for the selected AP.

Default Not set.

Mode Wireless AP Configuration

Example To configure a password for AP 100, use the following commands:

```
awplus# configure terminal
awplus(config)# wireless
awplus(config-wireless)# ap 100
awplus(config-wireless-ap)# login-password friend
```

Related commands [ap](#)
[show wireless ap](#)

Command changes Version 5.4.7-2.4: command added.

mac-address (wireless-ap)

Overview Use this command to specify the MAC address for a wireless Access Point (AP).
Use the **no** variant of this command to remove the MAC address of the selected wireless AP.

Syntax `mac-address <mac-address>`
`no mac-address`

Parameter	Description
<code><mac-address></code>	The MAC address of the wireless AP in hexadecimal notation with the format HHHH.HHHH.HHHH.

Default Not set.

Mode Wireless AP Configuration

Example To specify a MAC address for a wireless AP, use the following commands:

```
awplus# configure terminal
awplus(config)# wireless
awplus(config-wireless)# ap 100
awplus(config-wireless-ap)# mac-address 0000.5e00.5301
```

Related commands [ap](#)
[show wireless ap](#)

Command changes Version 5.4.7-2.4: command added.

mac-auth password

Overview Use this command to change the password for MAC-based authentication. Use the **no** variant of this command to return the password to its default.

Syntax `mac-auth password <password>`
`no mac-auth password`

Parameter	Description
<code><password></code>	The new password. Passwords can be up to 64 characters in length and can contain any printable characters except ?, " (double quotes), and spaces.

Default By default the password is the MAC address of the supplicant.

Mode Wireless Network Configuration

Example To set the password for MAC authentication to be 'SECRET', use the following commands:

```
awplus# configure terminal
awplus(config)# wireless
awplus(config-wireless)# network 20
awplus(config-wireless-network)# mac-auth password SECRET
```

To reset the password for MAC authentication to the default, use the following commands:

```
awplus# configure terminal
awplus(config)# wireless
awplus(config-wireless)# network 20
awplus(config-wireless-network)# no mac-auth password
```

Related commands [enable \(wireless-network-cp\)](#)
[network \(wireless\)](#)
[mac-auth radius auth group \(wireless-network\)](#)
[mac-auth username](#)

Command changes Version 5.4.9-2.1: command added

mac-auth radius auth group (wireless-network)

Overview Use this command to enable MAC authentication of clients with a RADIUS group in a wireless network.

Use the **no** variant of this command to disable MAC authentication with a RADIUS group.

Syntax `mac-auth radius auth group {radius|<group-name>}`
`no mac-auth radius auth group`

Parameter	Description
<code>radius</code>	Use a RADIUS group, which means all RADIUS servers.
<code><group-name></code>	The RADIUS server group.

Default Not set.

Mode Wireless Network.

Usage notes This command enables MAC authentication and designates a RADIUS server group to authenticate clients on a wireless network. RADIUS server groups are defined using the **aaa group server** command. RADIUS server groups can consist of multiple server hosts, but this command only uses two servers.

Example To enable MAC authentication with a RADIUS server group, use the following commands:

```
awplus# configure terminal
awplus(config)# wireless
awplus(config-wireless)# network 10
awplus(config-wireless-network)# mac-auth radius auth group
radius
```

Related commands [network \(wireless\)](#)

Command changes Version 5.4.7-2.4: command added.

mac-auth username

Overview Use this command to set the format of the MAC address in the username and password field when a request for MAC-based authorization is sent to a RADIUS server.

Use the **no** variant of this command to reset the format to the default of hyphen and lower-case.

Syntax `mac-auth username {hyphen|colon|unformatted}
{lower-case|upper-case}`
`no mac-auth username`

Parameter	Description
hyphen	The MAC address includes hyphens, e.g. xx-xx-xx-xx-xx-xx.
colon	The MAC address includes colons, e.g. xx:xx:xx:xx:xx:xx.
unformatted	The MAC address does not include hyphens or colons, e.g. xxxxxxxxxxxx.
lower-case	The MAC address uses lower-case characters (a-f).
upper-case	The MAC address uses upper-case characters (A-F).

Default Default format is hyphen lower-case.

Mode Wireless Network Configuration

Example To configure the format of the MAC address in the username and password field to be colon and upper-case, use the following commands:

```
awplus# configure terminal
awplus(config)# wireless
awplus(config-wireless)# network 20
awplus(config-wireless-network)# mac-auth username colon
upper-case
```

To reset the format of the MAC address in the username and password field to the default, use the following commands:

```
awplus# configure terminal
awplus(config)# wireless
awplus(config-wireless)# network 20
awplus(config-wireless-network)# no mac-auth username
```

Related commands [enable \(wireless-network-cp\)](#)
[mac-auth password](#)
[mac-auth radius auth group \(wireless-network\)](#)

network (wireless)

Command changes Version 5.4.9-2.1: command added

management address

Overview Use this command to configure a management address on the router for transmitting Autonomous Wave Control (AWC) packets to Access Points (APs). The management address must already exist on a device interface.

Use the **no** variant of this command to turn off AP management by AWC on the management address.

Syntax `managment address <ipv4-addr>`
`no management address`

Parameter	Description
<code><ipv4-addr></code>	Set the IPv4 interface address used for AP management by AWC.
<code>no</code>	Unset the IPv4 management address used for AP management by AWC.

Default Not enabled.

Mode Wireless Configuration

Example To configure an AP management interface address, use the following commands:

```
awplus# configure terminal
awplus(config)# wireless
awplus(config-wireless)# management address 192.168.0.1
```

To remove an AP management interface address, use the following commands:

```
awplus# configure terminal
awplus(config)# wireless
awplus(config-wireless)# no management address
```

Related commands [enable \(wireless\)](#)

Command changes Version 5.4.7-2.4: command added.

management-frame-protection enable (wireless-sec-osen)

Overview Use this command to enable management frame protection (MFP) for wireless Access Points (APs) using the OSEN security mode.

MFP provides security for management messages passed between APs and client stations. MFP checks management messages for potential security issues such as rogue devices and denial-of-service attacks.

Use the **no** variant of this command to disable MFP.

Syntax `management-frame-protection enable [type {capable|required}]`
`no management-frame-protection enable`

Parameter	Description
<code>type</code>	The type of protection, select capable or required . If protection type is omitted, then capable is the default protection type.
<code>capable</code>	Mixed operation. Allows legacy devices that do not support 802.11w to associate while also allowing devices that support 802.11w to use the 802.11w features.
<code>required</code>	Prevents clients that do not support 802.11w from associating with the SSID.

Default Enabled.

Mode Wireless Security OSEN Configuration

Usage notes Select the protection **type** based on the WPA version:

If the WPA version is:

- a combination of **wpa** and **wpa2**, then protection is disabled
- only **wpa2**, then the protection type can be either **capable**, **required**, or **disabled**
- only **wpa3**, then the protection type is **required**

Example To enable management frame protection for clients that do not support 802.11w, use the commands:

```
awplus# configure terminal
awplus(config)# wireless
awplus(config-wireless)# security 110 mode osen
awplus(config-wireless-sec-osen)# management-frame-protection
enable type required
```

To disable management frame protection, use the commands:

```
awplus# configure terminal
awplus(config)# wireless
awplus(config-wireless)# security 110 mode osen
awplus(config-wireless-sec-osen)# no
management-frame-protection enable
```

**Related
commands**

[security \(wireless\)](#)
[show wireless security](#)
[versions \(wireless-sec-osen\)](#)

**Command
changes**

Version 5.5.0-2.3: command added

management-frame-protection enable (wireless-sec-wpa-ent)

Overview Use this command to enable management frame protection (MFP) in a WPA-enterprise configuration.

MFP provides security for management messages passed between wireless Access Points (APs) and client stations. MFP checks management messages for potential security issues such as rogue devices and denial-of-service attacks.

Use the **no** variant of this command to disable MFP.

Syntax `management-frame-protection enable [type{capable|required}]`
`no management-frame-protection enable`

Parameter	Description
<code>type</code>	The type of protection, select capable or required . If protection type is omitted, then capable is the default protection type.
<code>capable</code>	Mixed operation. Allows legacy devices that do not support 802.11w to associate while also allowing devices that support 802.11w to use the 802.11w features.
<code>required</code>	Prevents clients that do not support 802.11w from associating with the SSID.

Default Enabled.

Mode Wireless Security WPA-enterprise Configuration

Usage notes Select the protection **type** based on the WPA version:

If the WPA version is:

- a combination of **wpa** and **wpa2**, then protection is disabled
- only **wpa2**, then the protection type can be either **capable**, **required**, or **disabled**
- only **wpa3**, then the protection type is **required**

Example To **disable** MFP, use the following commands:

```
awplus# configure terminal
awplus(config)# wireless
awplus(config-wireless)# security 110 mode wpa-enterprise
awplus(config-wireless-sec-wpa-psnl)# no
management-frame-protection enable
```

Related commands [security \(wireless\)](#)
[versions \(wireless-sec-wpa-ent\)](#)
[show wireless security](#)

Command changes Version 5.4.7-2.4: command added.
Version 5.5.0-2.3: parameter **type** added

management-frame-protection enable (wireless-sec-wpa-psnl)

Overview Use this command to enable Management Frame Protection (MFP). MFP provides security for management messages passed between wireless Access Points (APs) and client stations. MFP checks management messages for potential security issues such as rogue devices and denial-of-service attacks.

This parameter will be ignored when the version list includes **wpa3** as WPA3 requires that MFP is enabled, see [versions \(wireless-sec-wpa-psnl\)](#).

Use the **no** variant of this command to disable MFP.

Syntax `management-frame-protection enable [type {capable | required}]`
`no management-frame-protection enable`

Parameter	Description
<code>type</code>	The type of protection, select capable or required . If protection type is omitted, then capable is the default protection type.
<code>capable</code>	Mixed operation. Allows legacy devices that do not support 802.11w to associate while also allowing devices that support 802.11w to use the 802.11w features.
<code>required</code>	Prevents clients that do not support 802.11w from associating with the SSID.

Default Enabled.

Mode Wireless Security WPA-personal Configuration

Usage notes Select the protection **type** based on the WPA version:

If the WPA version is:

- a combination of **wpa** and **wpa2**, then protection is disabled
- only **wpa2**, then the protection type can be either **capable**, **required**, or **disabled**
- only **wpa3**, then the protection type is **required**

Example To disable MFP, use the following commands:

```
awplus# configure terminal
awplus(config)# wireless
awplus(config-wireless)# security 100 mode wpa-personal
awplus(config-wireless-sec-wpa-psnl)# no
management-frame-protection enable
```

Related commands [security \(wireless\)](#)
[versions \(wireless-sec-wpa-ent\)](#)
[show wireless security](#)

Command changes Version 5.4.7-2.4: command added.
Version 5.5.0-2.3: parameter **type** added

max-clients

Overview Use this command to set the number of clients able to connect to a wireless Access Point (AP).

Use the **no** variant of this command to return the number of clients able to connect to the default value.

Syntax `max-clients <0-200>`
`no max-clients`

Parameter	Description
<code><0-200></code>	The number of clients able to connect to the wireless AP. Configuring the number 0 will disable all clients from connecting to the selected AP. For the MWS series, the range is: <code><0-127></code> with a default of 127.

Default 200.

Mode Wireless AP Profile Radio Configuration

Example To set the maximum number of clients that can connect to a wireless AP to 100, use the following commands:

```
awplus# configure terminal
awplus(config)# wireless
awplus(config-wireless)# ap-profile 100
awplus(config-wireless-ap-prof)# radio 2
awplus(config-wireless-ap-prof-radio)# max-clients 100
```

Related commands [radio \(wireless-ap-profile\)](#)

Command changes Version 5.4.7-2.4: command added.

mode (wireless-ap-prof-radio)

Overview Use this command to set the **wireless standard** and **bandwidth** mode used by the Access Points (APs) in a secure wireless security configuration. The AP type or model determines which mode to select.

Use the **no** variant of this command to set the mode to the default values specified for an AP type.

Syntax mode {a|bg|a-n|bg-n|n-only-a|n-only-g|a-n-ac|n-ac}
no mode

Parameter	Standard	Description
a	802.11a	Bandwidth 54Mbps - 5GHz
bg	802.11bg	Bandwidths 11 and 54Mbps- 2.4GHz.
a-n	802.11a/n	Bandwidths 54 and 300 Mbps - 2.4GHz.
bg-n	802.11b/g/n	Bandwidths 11, 54, and 300 Mbps - 2.4GHz
n-only-a	802.11n	Bandwidth 300 Mbps using the 5GHz bandwidth
n-only-g	802.11n	Bandwidth 300 Mbps using the 2.4GHz bandwidth
a-n-ac	802.11a/n/ac	Dual-band: supporting simultaneous connections on both the 2.4 GHz and 5 GHz Wi-Fi bands. 802.11ac offers backward compatibility to 802.11b/g/n and bandwidth rated up to 1300 Mbps on the 5 GHz band plus up to 450 Mbps on 2.4 GHz.
n-ac	802.11n/ac	Dual-band: Bandwidth 54, and 300Mbps using both the 2.4 and 5GHz frequencies.

Default The default values change with each antenna type and AP.

Mode Wireless AP Profile Radio Configuration

Example To configure the wireless mode **a-n-ac** for AP profile 100, radio 2, use the following commands:

```
awplus# configure terminal
awplus(config)# wireless
awplus(config-wireless)# ap-profile 100
awplus(config-wireless-ap-prof)# radio 2
awplus(config-wireless-ap-prof-radio)# mode a-n-ac
```

Related commands [country-code](#)
[hwtype](#)
[radio \(wireless-ap-profile\)](#)

Command changes Version 5.4.7-2.4: command added.

mode (wireless-network-cp)

Overview Use this command to set the Captive Portal (web authentication) mode.

Captive Portal lets wireless clients authenticate themselves or agree to terms and conditions before you grant them Wi-Fi access or external web access.

Use the **no** variant of this command to reset the Captive Portal mode to default.

Syntax mode {click-through|radius|external-page-redirect}
no mode

Parameter	Description
radius	The user name and password entered from the browser screen are sent to the RADIUS server and a network connection is permitted after successful authentication.
click-through	This method asks users to agree to the terms of use (click-through agreement) before allowing them to connect to the wireless network.
external-page-redirect	Redirect the authentication page to a user configured URL such as a third party Captive Portal vendor page.

Default click-through

Mode Wireless Network Captive Portal Configuration

Usage notes Click-through is only valid for TQ4400, TQ4600, TQ4400e, TQ1402, TQ5403, TQ5403e, TQm1402, and TQm5403 wireless access points.

Click-through is not supported on TQ2450, TQ3200, TQ3400 or TQ3600 APs. Set the mode to **radius** (external RADIUS authentication) for these devices.

Example To set the Captive Portal authentication mode as RADIUS, use the commands:

```
awplus# configure terminal
awplus(config)# wireless
awplus(config-wireless)# network 20
awplus(config-wireless-network)# captive-portal
awplus(config-wireless-network-cp)# mode radius
```

Related commands

- [captive-portal](#)
- [enable \(wireless-network-cp\)](#)
- [mac-auth password](#)
- [mac-auth username](#)
- [page-proxy-url](#)

radius auth group (wireless-network-cp)

redirect-url

session-keep

**Command
changes**

Version 5.4.9-1.1: command added

Version 5.5.0-1.3: **external-page-redirect** parameter added

nai-realm

(wireless-network-passpoint-dot11u)

Overview Use this command to set the NAI (Network Access Identifier) Realm information. Use the **no** variant of this command to remove a specified NAI Realm entry.

Syntax `nai-realm <realm-number> realm-name <realm-name> eap-method <eap-method>`
`no nai-realm <realm-number>`

Parameter	Description
<code><realm-number></code>	NAI Realm information's unique entry number in the range <1-10>
<code><realm-name></code>	NAI Realm name: <ul style="list-style-type: none">• The NAI Realm Name in FQDN (Fully Qualified Domain Name) format.• Multiple NAI Realm Names must be separated by a comma.• The maximum number of characters allowed including commas is 100.
<code><eap-method></code>	Designated EAP method(s) in a list format. The list can use either eap-tls or eap-ttls or eap-sim or two of these three in any order.

Default Not set.

Mode Wireless Network Passpoint 802.11u Configuration

Usage notes A network access identifier (NAI) is a standardized (RFC 4282) format for identifying users requesting access to a network (e.g.user@realm.com). Thus, an NAI Realm identifies the proper authentication server or domain for the user's authentication exchange.

Example To configure an NAI Realm Name and EAP method(s), use the commands:

```
awplus# configure terminal
awplus(config)# wireless
awplus(config-wireless)# network 1
awplus(config-wireless-network)# passpoint
awplus(config-wireless-network-passpoint)# dot11u
awplus(config-wireless-network-passpoint-dot11u)# nai-realm 2
realm-name example.com eap-method eap-tls eap-ttls
```

Related commands [show wireless network](#)
[dot11u \(wireless-network-passpoint\)](#)

Command changes Version 5.5.0-2.3: command added

neighbor-ap-detection enable

Overview Use this command to enable Neighbor AP Detection on the AP profile radio configuration.

Use the **no** variant of this command to disable Neighbor AP Detection for an AP profile radio configuration.

Syntax neighbor-ap-detection enable
no neighbor-ap-detection enable

Default Enable.

Mode Wireless AP Profile Radio Configuration

Example To disable Neighbor AP Detection for APs using AP profile 1, use the commands:

```
awplus# configure terminal
awplus(config)# wireless
awplus(config-wireless)# ap-profile 1
awplus(config-wireless-ap-prof)# radio 1
awplus(config-wireless-ap-prof-radio)# no
neighbor-ap-detection enable
```

Related commands [show wireless ap-profile](#)
[radio \(wireless-ap-profile\)](#)

Command changes Version 5.5.1-0.1: command added

neighbor-managed-ap-detection enable

Overview Use this command to enable Neighbor AP Detection for all managed APs on the wireless network.

Use the **no** variant of this command to disable Neighbor AP Detection for all managed APs on the wireless network.

Syntax neighbor-managed-ap-detection enable
no neighbor-managed-ap-detection enable

Default Enabled.

Mode Wireless Configuration

Example To disable Neighbor AP Detection for all managed APs, use the commands:

```
awplus# configure terminal
awplus(config)# wireless
awplus(config-wireless)# no neighbor-managed-ap-detection
enable
```

Related commands [show wireless](#)
[wireless](#)

Command changes Version 5.5.1-0.1: command added

network-auth-type (wireless-network-passpoint-dot11u)

Overview Use this command to set the network authentication type.

Use the **no** variant of this command to remove the specified network authentication type.

Syntax

```
network-auth-type  
{online-enrollment|terms-and-conditions|redirect-http-https|  
redirect-dns} [redirect-url <url>]  
  
no network-auth-type  
{online-enrollment|terms-and-conditions|redirect-http-https|  
redirect-dns}
```

Parameter	Description
online-enrollment	Authentication type as online enrollment.
terms-and-conditions	Authentication type as terms and conditions.
redirect-http-https	Redirect using HTTP/HTTPS.
redirect-dns	Redirect using DNS.
redirect url <url>	Redirect using URL. The URL is an ASCII string of up to 128 characters other than the following characters: {, }, , \, ^, [,], ` Refer to RFC-2396

Default Not set.

Mode Wireless Network Passpoint 802.11u Configuration

Example To set the network authentication type as online-enrollment with a redirect URL, use the commands:

```
awplus# configure terminal  
awplus(config)# wireless  
awplus(config-wireless)# network 1  
awplus(config-wireless-network)# passpoint  
awplus(config-wireless-network-passpoint)# dot11u  
awplus(config-wireless-network-passpoint-dot11u)#  
network-auth-type online-enrollment redirect-url example.com
```

To delete the network authentication type online-enrollment, use the commands:

```
awplus# configure terminal
awplus(config)# wireless
awplus(config-wireless)# network 1
awplus(config-wireless-network)# passpoint
awplus(config-wireless-network-passpoint)# dot11u
awplus(config-wireless-network-passpoint-dot11u)# no
network-auth-type online-enrollment
```

- Related commands** [show wireless network](#)
[dot11u \(wireless-network-passpoint\)](#)
- Command changes** Version 5.5.0-2.3: command added

network-type (wireless-network-passpoint-dot11u)

Overview Use this command to select the access network type.

Use the **no** variant of this command to revert to the default access network type.

Syntax `network-type {private|guest-private|chargeable-public|free-public|personal-device|emergency|test|wildcard}`
`no network-type`

Parameter	Description
private	Private network
guest-private	Private network with guest access
chargeable-public	Chargeable public network
free-public	Free public network
personal-device	Personal device network
emergency	Emergency service only network
test	Test or experimental network
wildcard	Wildcard

Default Private.

Mode Wireless Network Passpoint 802.11u Configuration

Example To enter the 802.11u configuration mode and set the network access type to free-public, use the commands:

```
awplus# configure terminal
awplus(config)# wireless
awplus(config-wireless)# network 1
awplus(config-wireless-network)# passpoint
awplus(config-wireless-network-passpoint)# dot11u
awplus(config-wireless-network-passpoint-dot11u)# network-type
free-public
```

Related commands [show wireless network](#)
[dot11u \(wireless-network-passpoint\)](#)
[passpoint](#)
[network-auth-type \(wireless-network-passpoint-dot11u\)](#)

Command changes Version 5.5.0-2.3: command added

network (wireless)

Overview Use this command to configure an Autonomous Wave Control (AWC) network. If the network doesn't exist, then this command creates it. Use the **no** variant of this command to remove an AWC network.

Syntax `network <1-65535>`

Parameter	Description
<code><1-65535></code>	The network ID number

Default Not set.

Mode Wireless Configuration

Usage notes This command adds a network configuration and enters the network configuration mode.

Example To configure an AWC network with an ID of 20, use the following commands:

```
awplus# configure terminal
awplus(config)# wireless
awplus(config-wireless)# network 20
```

Related commands

- [show wireless network](#)
- [vap \(wireless-ap-prof-radio\)](#)
- [description \(wireless-network\)](#)
- [vlan \(wireless-network\)](#)
- [ssid \(wireless-network\)](#)
- [hide-ssid \(wireless-network\)](#)
- [band-steering \(wireless-network\)](#)
- [security \(wireless-network\)](#)
- [vap \(wireless-ap-prof-radio\)](#)

Command changes Version 5.4.7-2.4: command added.

ntp designated-server

Overview Use this command to designate the NTP server that a wireless Access point (AP) refers to.

Use the **no** variant of this command to remove the configured IP address or host-name of the NTP server.

Syntax `ntp designated-server {ip <ip-address>|host <host-name>}`
`no ntp designated-server`

Parameter	Description
<code><ip-address></code>	Specify the IP address of the NTP server, entered in the form A.B.C.D for an IPv4 address.
<code><host-name></code>	Specify the host-name for the NTP server

Default Disabled.

Mode Wireless AP Profile Configuration

Usage notes This command sets the NTP server that a wireless AP refers to. If the NTP server is disabled, then the AP will synchronize its time with the AWC router.

This is because the AP can not hold current time after a reboot because it does not have a real-time clock.

Therefore, the NTP master must be configured on the AWC router.

Example To configure an NTP server with an IP address of 192.168.0.254 for ap-profile 100, use the following commands:

```
awplus# configure terminal
awplus(config)# wireless
awplus(config-wireless)# ap-profile 100
awplus(config-wireless-ap-prof)# ntp designated-server
192.168.0.154
```

Related commands [ap-profile \(wireless\)](#)
[show wireless ap-profile](#)
[ntp designated-server period](#)

Command changes Version 5.4.7-2.4: command added

ntp designated-server enable

Overview Use this command to configure NTP on a wireless Access Point (AP).
Use the **no** variant of this command to disable the NTP feature on an AP.

Syntax ntp designated-server enable
no ntp designated-server enable

Default Enabled.

Mode Wireless AP Profile Configuration

Example To disable NTP for AP-profile 100, use the following commands:

```
awplus# configure terminal
awplus(config)# wireless
awplus(config-wireless)# ap-profile 100
awplus(config-wireless-ap-prof)# no ntp designated-server
enable
```

Related commands [ntp designated-server](#)

Command changes Version 5.4.7-2.4: command added.

ntp designated-server period

Overview Use this command to set the time adjustment period for an NTP server. This is the time adjustment period for a wireless AP using the selected AP profile.

Use the **no** variant of this command to reset the time adjustment period to the default of 10 minutes.

Syntax `ntp designated-server period <1-9999>`
`no ntp designated-server period`

Parameter	Description
<code><1-9999></code>	The time adjustment period for the NTP server in minutes.

Default 10 minutes.

Mode Wireless AP Profile Configuration

Example To configure 30 minutes as the NTP server time adjustment period for ap-profile 100, use the following commands:

```
awplus# configure terminal
awplus(config)# wireless
awplus(config-wireless)# ap-profile 100
awplus(config-wireless-ap-prof)# ntp designated-server
192.168.0.254
awplus(config-wireless-ap-prof)# ntp designated-server period
30
```

Related commands [ap-profile \(wireless\)](#)
[show wireless ap-profile](#)
[ntp designated-server](#)

Command changes Version 5.4.7-2.4: command added.

operating-class (wireless-network-passpoint-hs20)

Overview Use this command to set the Operating Class for Hotspot 2.0.
Use the **no** variant of this command to revert to the default value.

Syntax `operating-class <HEX-value>`
`no operating-class`

Parameter	Description
<code><HEX-value></code>	Operating Class Indication value in HEX. Refer to Table E-4 of IEEE Std 802.11-2012 Annex E

Default 51

Mode Wireless Network Passpoint Hotspot 2.0 Configuration

Example To set an Operating Class Indication value of 51, use the commands:

```
awplus# configure terminal
awplus(config)# wireless
awplus(config-wireless)# network 1
awplus(config-wireless-network)# passpoint
awplus(config-wireless-network-passpoint)# hs20
awplus(config-wireless-network-passpoint-hs20)#
operating-class 51
```

Related commands [show wireless network](#)
[hs20 \(wireless-network-passpoint\)](#)

Command changes Version 5.5.0-2.3: command added

operator (wireless-network-passpoint-hs20)

Overview Use this command to configure the operator friendly name, unique entry number, and language code of a Hotspot 2.0 entry.

Use the **no** variant of this command to remove the configuration details of a Hotspot 2.0 entry.

Syntax `operator <operator-id> lang <language-code> friendly-name
<friendly-name>`
`no operator <operator-id>`

Parameter	Description
<code><operator-id></code>	The unique operator entry number. Select from the range 1-10.
<code><language-code></code>	The language code. You can use only 2 or 3 characters as specified in ISO-639. For example: English is 'eng', Japanese is 'jpn'.
<code><friendly-name></code>	The text field used to identify the Hotspot venue operator. You can use up to 252 octets of special characters (utf-8 encode). For example: "Allied Bld.5th floor".

Default Not set

Mode Wireless Network Passpoint Hotspot 2.0 Configuration

Example To configure the language code and operator friendly name on Operator ID 2, use the commands:

```
awplus# configure terminal
awplus(config)# wireless
awplus(config-wireless)# network 1
awplus(config-wireless-network)# passpoint
awplus(config-wireless-network-passpoint)# hs20
awplus(config-wireless-network-passpoint-hs20)# operator 2
lang eng friendly-name Allied-Telesis
```

Related commands [show wireless network](#)
[hs20 \(wireless-network-passpoint\)](#)

Command changes Version 5.5.0-2.3: command added

osu-providers friendly-name lang name

Overview Use this command to set the OSU Providers Friendly Name. This information is required with Passpoint Hotspot2.0 configurations.

Use the **no** variant of this command to remove the specified OSU Providers Friendly Name.

Syntax `osu-providers friendly-name lang <language-code> name <friendly-name>`
`no osu-providers friendly-name lang <language-code> name <friendly-name>`

Parameter	Description
<code><language-code></code>	The language code. You can use only 2 or 3 characters as specified in ISO-639. For example: English is 'eng', Japanese is 'jpn'.
<code><friendly-name></code>	The text field used to identify the OSU operator. You can use up to 252 octets of special characters (utf-8 encode). For example: "Allied Bld.5th floor".

Default None.

Mode Wireless Network Passpoint Hotspot 2.0 Configuration

Example To configure the OSU Provider's Friendly Name, use the commands:

```
awplus# configure terminal
awplus(config)# wireless
awplus(config-wireless)# network 1
awplus(config-wireless-network)# passpoint
awplus(config-wireless-network-passpoint)# hs20
awplus(config-wireless-network-passpoint-hs20)# osu-providers
friendly-name lang eng name Example operator
```

Related commands [show wireless network](#)

[osu status enable](#)

[osu ssid](#)

[osu-providers nai](#)

[osu-providers method-list](#)

[osu-providers service-desc lang desc](#)

[osu-providers icon lang file](#)

[osu-providers server-uri](#)

Command changes Version 5.5.2-0.1: command added

osu-providers icon lang file

Overview Use this command to set the Online Sign-up (OSU) provider icon for a Hotspot2.0 configuration.

When OSU services are available, a list of the OSU providers that are reachable from the hotspot are presented to the client. The list is typically displayed as an icon, title, and description, for each provider. The icon is actually embedded within the certificate issued to the OSU server, thus ensuring that clients don't connect to 'rogue' provisioning systems.

Use the **no** variant of this command to remove an OSU provider icon.

Syntax `osu-providers icon lang <language-code> file <file-name>`
`no osu-providers icon lang <language-code> file <file-name>`

Parameter	Description
<code><language-code></code>	The language code. You can use only 2 or 3 characters as specified in ISO-639. For example: English is 'eng', Japanese is 'jpn'.
<code><file-name></code>	The icon's file name: Range: <= 255 characters Format: ASCII printable string without the following characters: \/:*?"<> Extensions: .png only. Size: < 64K Byte.

Default N/A.

Mode Wireless Network Passpoint Hotspot 2.0 Configuration

Example To set the OSU provider icon, use the commands:

```
awplus# configure terminal
awplus(config)# wireless
awplus(config-wireless)# network 1
awplus(config-wireless-network)# passpoint
awplus(config-wireless-network-passpoint)# hs20
awplus(config-wireless-network-passpoint-hs20)# osu-providers
icon lang eng file TestIcon.png
```

To copy the OSU Provider icon from USB to flash, use the command:

```
awplus# copy usb:/TestIcon.png flash:/gui-userdata/osu-icon/
```

To check the OSU Provider icon file, use the command:

```
awplus# dir flash:/gui-userdata/osu-icon/
```

Related commands show wireless network
osu status enable
osu ssid
osu-providers nai
osu-providers method-list
osu-providers service-desc lang desc
osu-providers server-uri

Command changes Version 5.5.2-0.1: command added

osu-providers method-list

Overview Use this command to set the list of protocols (methods) that OSU Providers use to communicate between mobile devices.

Use the **no** variant of this command to reset the OSU Providers method list.

Syntax

```
osu-providers method-list oma-dm
osu-providers method-list soap-xml-spp
osu-providers method-list oma-dm soap-xml-spp
osu-providers method-list soap-xml-spp oma-dm
no osu-providers method-list
```

Parameter	Description
oma-dm	Provisioning using Open Mobile Alliance (OMA) Device Management (DM)
soap-xml-spp	Provisioning using Subscription Provisioning Protocol based on Simple Object Access Protocol XML.

Default Not set.

Mode Wireless Network Passpoint Hotspot 2.0 Configuration

Usage notes The list includes the OMA-DM and SOAP-XML SPP protocols. You can configure the list priority. For example, **oma-dm soap-xml-spp** indicates the method OMA-DM has a higher priority than SOAP-XML-SPP.

Example To set the OSU Providers method list to OMA-DM and SOAP-XML SPP, use the commands:

```
awplus# configure terminal
awplus(config)# wireless
awplus(config-wireless)# network 1
awplus(config-wireless-network)# passpoint
awplus(config-wireless-network-passpoint)# hs20
awplus(config-wireless-network-passpoint-hs20)# osu-providers
method-list oma-dm soap-xml-spp
```

Related commands

- [show wireless network](#)
- [osu status enable](#)
- [osu ssid](#)
- [osu-providers nai](#)
- [osu-providers service-desc lang desc](#)

osu-providers icon lang file

osu-providers server-uri

osu-providers friendly-name lang name

Command changes Version 5.5.2-0.1: command added

osu-providers nai

Overview Use this command to configure the OSU Providers NAI (Network Access Identifier) on a Hotspot2.0 configuration.
Use the **no** variant of this command to remove a specified NAI Realm entry.

Syntax `osu-providers nai <realm-name>`
`no osu-providers nai <realm-name>`

Parameter	Description
<code><realm-name></code>	NAI Realm name: <ul style="list-style-type: none">The NAI Realm Name in FQDN (Fully Qualified Domain Name) format, as described in RFC4282, Section 2.8. For example, <code>realm@example.com</code>Range: <253 octets

Default Not set.

Mode Wireless Network Passpoint Hotspot 2.0 Configuration

Example To configure the OSU Provider NAI, use the commands:

```
awplus# configure terminal
awplus(config)# wireless
awplus(config-wireless)# network 1
awplus(config-wireless-network)# passpoint
awplus(config-wireless-network-passpoint)# hs20
awplus(config-wireless-network-passpoint-hs20)# osu-providers
nai realm@example.com
```

Related commands

- [osu ssid](#)
- [osu-providers server-uri](#)
- [show wireless network](#)
- [osu status enable](#)
- [osu-providers friendly-name lang name](#)
- [osu-providers nai](#)
- [osu-providers method-list](#)
- [osu-providers service-desc lang desc](#)
- [osu-providers icon lang file](#)

Command changes Version 5.5.2-0.1: command added

osu-providers server-uri

Overview Use this command to configure the OSU Providers Server URI (Uniform Resource Identifier). You will need to set this on Passpoint Hotspot2.0 configurations.

Use the **no** variant of this command to reset the OSU Providers Server URI.

Syntax `osu-providers server-uri <uri>`
`no osu-providers server-uri`

Parameter	Description
<code><uri></code>	The OSU Providers Server URI. Range: <= 253 characters, Format: ASCII printable characters.

Default Not set.

Mode Wireless Network Passpoint Hotspot 2.0 Configuration

Example To configure the OSU Provider's Server URI, use the commands:

```
awplus# configure terminal
awplus(config)# wireless
awplus(config-wireless)# network 1
awplus(config-wireless-network)# passpoint
awplus(config-wireless-network-passpoint)# hs20
awplus(config-wireless-network-passpoint-hs20)# osu-providers
server-uri https://example.com/osu/
```

Related commands

- `osu ssid`
- `show wireless network`
- `osu status enable`
- `osu-providers friendly-name lang name`
- `osu-providers nai`
- `osu-providers method-list`
- `osu-providers service-desc lang desc`
- `osu-providers icon lang file`

Command changes Version 5.5.2-0.1: command added

osu-providers service-desc lang desc

Overview Use this command to set the OSU Providers Service Description. This information is required with Passpoint Hotspot2.0 configurations.

Use the **no** variant of this command to remove an OSU Providers Service Description.

Syntax `osu-providers service-desc lang <language-code> desc <service-name>`
`no osu-providers service-desc lang <language-code> desc <service-name>`

Parameter	Description
<code><language-code></code>	The language code. You can use only 2 or 3 characters as specified in ISO-639. For example: English is 'eng', Japanese is 'jpn'.
<code><service-name></code>	The text field used to identify the OSU Providers Service. You can use up to 252 octets of special characters (utf-8 encode).

Default Not set.

Mode Wireless Network Passpoint Hotspot 2.0 Configuration

Example To configure the OSU Provider's Service Description, use the commands:

```
awplus# configure terminal
awplus(config)# wireless
awplus(config-wireless)# network 1
awplus(config-wireless-network)# passpoint
awplus(config-wireless-network-passpoint)# hs20
awplus(config-wireless-network-passpoint-hs20)# osu-providers
service-desc lang eng desc Example Service
```

Related commands

- [osu ssid](#)
- [osu-providers server-uri](#)
- [show wireless network](#)
- [osu status enable](#)
- [osu-providers friendly-name lang name](#)
- [osu-providers nai](#)
- [osu-providers method-list](#)
- [osu-providers icon lang file](#)

Command changes Version 5.5.2-0.1: command added

osu ssid

Overview Use this command to set the Online-signup (OSU) SSID that wireless clients will use with a Hotspot2.0 configuration.

Use the **no** variant of this command to reset the OSU Status configuration.

Syntax `osu ssid <ssid-value>`
`no osu ssid`

Parameter	Description
<code><ssid-value></code>	The OSU SSID for the Hotspot2.0 configuration. Enter a string up to 32 characters in length. If the name contains spaces then you must enclose it in "quotation marks". For example, "test ssid" requires quotes but test-ssid does not.

Default Not set.

Mode Wireless Network Passpoint Hotspot 2.0 Configuration

Usage notes The Passpoint OSU options allow you to register a mobile device with a service provider and choose a plan to gain network access. When you sign up, your device will send you user credentials to connect to the network.

Example To set an OSU SSID named 'test-ssid', use the commands:

```
awplus# configure terminal
awplus(config)# wireless
awplus(config-wireless)# network 1
awplus(config-wireless-network)# passpoint
awplus(config-wireless-network-passpoint)# hs20
awplus(config-wireless-network-passpoint-hs20)# osu ssid
test-ssid
```

To set an OSU SSID 'test ssid' (which contains a space), include double-quotes around the SSID, as shown in the following command:

```
awplus(config-wireless-network-passpoint-hs20)# osu ssid "test
ssid"
```

Related commands [show wireless network](#)

[osu status enable](#)

[osu-providers friendly-name lang name](#)

[osu-providers nai](#)

[osu-providers method-list](#)

osu-providers service-desc lang desc

osu-providers icon lang file

Command changes Version 5.5.2-0.1: command added

osu status enable

Overview Use this command to enable OSU (Online Sign-up). OSU is an optional setting included with Passpoint configuration on a wireless network. OSU allows you to register a mobile device with a service provider and choose a plan to gain network access. When you sign up, your device will send you user credentials to connect to the network.

Use the **no** variant of this command to disable OSU.

Syntax `osu status enable`
`no osu status enable`

Default Disabled.

Mode Wireless Network Passpoint Hotspot 2.0 Configuration

Example To enable OSU, use the commands:

```
awplus# configure terminal
awplus(config)# wireless
awplus(config-wireless)# network 1
awplus(config-wireless-network)# passpoint
awplus(config-wireless-network-passpoint)# hs20
awplus(config-wireless-network-passpoint-hs20)# osu status
enable
```

Related commands [show wireless network](#)
[osu ssid](#)
[osu-providers friendly-name lang name](#)
[osu-providers nai](#)
[osu-providers method-list](#)
[osu-providers service-desc lang desc](#)
[osu-providers icon lang file](#)

Command changes Version 5.5.2-0.1: command added

outdoor

Overview Use this command to designate that a wireless AP is located outdoors.
Use the **no** variant of this command to designate when a wireless AP is not located outdoors.

Syntax outdoor
no outdoor

Default No outdoor.

Mode Wireless AP Profile Configuration

Usage notes This command indicates whether the wireless AP is located outdoors, and selects the mode and channel that corresponds to this. To configure a channel number, use the **channel** command in **wireless-ap-prof-radio** mode. If you configure an invalid channel number, an error message displays the valid channels that you may select in your region.

The command is ignored when the AP is already configured using the **hwtype** command.

Example To configure an AP to be located outdoors, use the following commands:

```
awplus# configure terminal
awplus(config)# wireless
awplus(config-wireless)# ap-profile 2
awplus(config-wireless-ap-prof)# outdoor
```

Related commands [ap-profile \(wireless\)](#)
[show wireless ap-profile](#)
[channel \(wireless-ap-radio\)](#)
[bandwidth \(wireless-ap-prof-radio\)](#)
[channel \(wireless-ap-radio\)](#)

Command changes Version 5.4.7-2.4: command added

page-proxy-url

Overview Use this command in Captive Portal mode to set the location of the custom page to display for web authentication. This page will be displayed instead of the wireless access point's built-in authentication or click-through page.

Use the **no** variant of this command to remove the URL pointing to the custom web authentication page.

Syntax `page-proxy-url <URL>`
`no page-proxy-url`

Parameter	Description
<URL>	URL of external web server (hostname or dotted IP notation).

Default No custom page is set by default.

Mode Wireless Network Captive Portal Configuration

Usage notes This setting is valid only for AT-TQ5403, AT-TQm5403, AT-TQ5403e, AT-TQ1402, and AT-TQm1402 wireless access points.

Example To enable and set the web authentication proxy page, use the commands:

```
awplus# configure terminal
awplus(config)# wireless
awplus(config-wireless)# network 20
awplus(config-wireless-network)# captive-portal
awplus(config-wireless-network-cp)# page-proxy-url
http://www.mydomain.com/login_page
```

Related commands

- [captive-portal](#)
- [enable \(wireless-network-cp\)](#)
- [mac-auth password](#)
- [mac-auth username](#)
- [page-proxy-url](#)
- [radius auth group \(wireless-network-cp\)](#)
- [redirect-url](#)
- [session-keep](#)
- [mode \(wireless-network-cp\)](#)

Command changes Version 5.4.9-1.1: command added

passpoint

Overview Use this command to enter the passpoint configuration mode.
Use the **no** variant of this command to revert to the default setting.

Syntax `passpoint`
`no passpoint`

Default Not set.

Mode Wireless Network Configuration

Example To enter passpoint configuration mode, use the commands:

```
awplus# configure terminal
awplus(config)# wireless
awplus(config-wireless)# network 1
awplus(config-wireless-network)# passpoint
awplus(config-wireless-network-passpoint)#
```

Related commands [show wireless network](#)
[network \(wireless\)](#)
[enable \(wireless-network-passpoint\)](#)
[hs20 \(wireless-network-passpoint\)](#)
[dot11u \(wireless-network-passpoint\)](#)

Command changes Version 5.5.0-2.3: command added

peer (wireless-wds)

Overview Use this command to add a pair of wireless Access Points (APs) to a WDS peer list. Use the **no** variant of this command to remove a pair of wireless APs from a WDS peer list.

Syntax peer ap <1-65535> radio <1-3> {ap <1-65535>|mac <mac-addr>}
radio <1-3>
no peer

Parameter	Description
ap	Signifies that the first AP identifier follows.
<1-65535>	The first AP identifier.
radio	Select the radio interface of the first AP.
<1-3>	Designate the radio interface for the first AP.
ap	Signifies that the second AP identifier follows.
<1-65535>	The second AP identifier.
mac	Signifies that the MAC address of the second AP follows.
<mac-addr>	The MAC address of the second AP. Enter the address in the format <HHHH.HHHH.HHHH> where <i>H</i> is a hexadecimal number.
radio	Select the radio interface of the second AP.
<1-3>	The radio interface for the second AP.

Default There are no APs configured in a WDS peer list by default.

Mode Wireless WDS Configuration

Example To add a pair of wireless APs to a WDS peer list, use the following commands:

```
awplus# configure terminal
awplus(config)# wireless
awplus(config-wireless)# wds 10
awplus(config-wireless-wds)# peer ap 10 radio 1 ap 20 radio 1
```

Related commands wds
show wireless wds
ap

Command changes Version 5.4.7-2.4: command added.

permit host (wireless-ap-prof-snmp)

Overview Use this command to set the SNMP permit host for the target AP profile. This command is valid for SNMP v1 and v2c only.

Use the **no** variant of this command to remove the SNMP permit host from the AP profile.

Syntax permit host <host-name>
no permit host

Parameter	Description
<host-name>	Respond only to SNMP requests from the specified host name. For example FQDN, IP address, or subnet mask (manager.your.domain.com, 10.10.1.37, 192.168.1.1/24).

Default Not set

Mode Wireless AP Profile SNMP Configuration

Example To set the SNMP permit host to '192.168.1.1', use the commands:

```
awplus# configure terminal
awplus(config)# wireless
awplus(config-wireless)# ap-profile 2
awplus(config-wireless-ap-prof)# snmp
awplus(config-wireless-ap-prof-snmp)# permit host 192.168.1.1
```

To remove the SNMP permit host '192.168.1.1', use the commands:

```
awplus# configure terminal
awplus(config)# wireless
awplus(config-wireless)# ap-profile 2
awplus(config-wireless-ap-prof)# snmp
awplus(config-wireless-ap-prof-snmp)# no permit host
```

Related commands [show wireless ap-profile](#)
[snmp \(wireless-ap-prof\)](#)
[version \(wireless-ap-prof-snmp\)](#)

Command changes Version 5.5.0-2.1: command added

port (wireless-ap-prof-snmp)

Overview Use this command to set the SNMP listening port number for the target AP profile. Use the **no** variant of this command to set the SNMP listening port back to the default (161).

Syntax port <1-65535>
no port

Parameter	Description
<1-65535>	The SNMP listening port number to set.

Default 161

Mode Wireless AP Profile SNMP Configuration

Example To set the SNMP listening port to 166, use the commands:

```
awplus# configure terminal
awplus(config)# wireless
awplus(config-wireless)# ap-profile 2
awplus(config-wireless-ap-prof)# snmp
awplus(config-wireless-ap-prof-snmp)# port 166
```

To set the SNMP listening port back to the default (161), use the commands:

```
awplus# configure terminal
awplus(config)# wireless
awplus(config-wireless)# ap-profile 2
awplus(config-wireless-ap-prof)# snmp
awplus(config-wireless-ap-prof-snmp)# no port
```

Related commands [show wireless ap-profile](#)
[snmp \(wireless-ap-prof\)](#)
[version \(wireless-ap-prof-snmp\)](#)

Command changes Version 5.5.0-2.1: command added

power (wireless-ap-radio)

Overview Use this command to set the power level for client devices on a wireless Access Point (AP).
Use the **no** variant of this command to return the power level to its default value.

Syntax `power <1-100>`
`no power`

Parameter	Description
<code><1-100></code>	The percentage power level value.

Default A power level of 100% is the default.

Mode Wireless AP Radio Configuration

Example To set a power level of 30% for radio 2, use the following commands:

```
awplus# configure terminal
awplus(config)# wireless
awplus(config-wireless)# ap 100
awplus(config-wireless-ap)# radio 2
awplus(config-wireless-ap-radio)# power 30
```

Related commands [show wireless ap](#)
[radio \(wireless-ap\)](#)

Command changes Version 5.4.7-2.4: command added

pre-authentication enable (wireless-sec-osen)

Overview Use this command to allow wireless Access Points (APs) that have WPA2 clients to share the pre-authentication packets from the WPA2 clients with other APs.

When enabled, this speeds up authentication for roaming clients who connect to multiple APs.

Use the **no** variant of this command to disable pre-authentication

Syntax `pre-authentication enable`
`no pre-authentication enable`

Default Enabled.

Mode Wireless Security OSEN Configuration

Usage notes OSEN is a wireless security method used with Release 2 of Hotspot 2.0 (Passpoint) OSEN is short for Online Sign Up (OSU) Server-only Authenticated Layer 2 Encryption Network. Use the **security** command to enter OSEN security configuration mode.

This command is not supported by WPA clients.

Example To disable pre-authentication for an OSEN security configuration, use the commands:

```
awplus# configure terminal
awplus(config)# wireless
awplus(config-wireless)# security 210 mode osen
awplus(config-wireless-sec-osen)# no pre-authentication enable
```

Related commands [security \(wireless\)](#)
[show wireless security](#)

Command changes Version 5.5.0-2.3: command added

pre-authentication enable (wireless-sec-wpa-ent)

Overview Use this command to enable WPA-enterprise pre-authentication for Access Points (APs) that have WPA2 clients.

Use the **no** variant of this command to disable WPA-enterprise pre-authentication.

Syntax `pre-authentication enable`
`no pre-authentication enable`

Default Enabled.

Mode Wireless Security WPA-enterprise Configuration

Usage notes Enable this option if the AP has WPA2 clients and you want the AP to share the pre-authentication packets from the clients with other access points. If it is enabled, this can speed up authentication for roaming clients who connect to multiple access points. This option does not apply to WPA clients.

The MWS series of devices do not support pre-authentication, therefore, you should **disable** this command on these devices.

Example To disable pre-authentication on a WPA-enterprise configuration, use the following commands:

```
awplus# configure terminal
awplus(config)# wireless
awplus(config-wireless)# security 210 mode wpa-enterprise
awplus(config-wireless-sec-wpa-ent)# no pre-authentication
enable
```

Related commands [security \(wireless\)](#)

Command changes Version 5.4.7-2.4: command added

proxy-arp enable

Overview Use this command to enable proxy ARP on the wireless network. When Downstream Group-Addressed Forwarding (DGAF) is disabled, AlliedWare Plus enables Proxy ARP on the Access Points.

Use the **no** variant of this command to disable proxy ARP.

Syntax proxy-arp enable
no proxy-arp enable

Default Disabled.

Mode Wireless Network Configuration

Example To enable Proxy ARP, use the commands:

```
awplus# configure terminal
awplus(config)# wireless
awplus(config-wireless)# network 20
awplus(config-wireless-network)# proxy-arp enable
```

Related commands [show wireless network](#)
[network \(wireless\)](#)
[dgaf enable \(wireless-network-passpoint-hs20\)](#)

Command changes Version 5.5.0-2.3: command added

qos-map-set (wireless-network-passpoint-dot11u)

Overview Use this command to set the QoS map set for 802.11u.
Use the **no** variant of this command to revert to the default value.

Syntax `qos-map-set <qos-map>`
`no qos-map-set`

Parameter	Description
<code><qos-map></code>	<p>QoS map configuration.</p> <ul style="list-style-type: none">The QoS map is a comma delimited list of decimal values in the range 0-63 or 255.The maximum number of elements in the list is 29. (21(DSCP Exception) + 8(User Priority). Refer to: IEEE Std 802.11-2012, 8.4.2.97.Total length of QOSMAP < 190. <p>Format: [<DSCP Exceptions[DSCP,UP]>,<UP 0 range[low,high]>,...<UP 7 range[low,high]></p>

Default 0

Mode Wireless Network Passpoint 802.11u Configuration

Example To configure the qos map set, use the commands:

```
awplus# configure terminal
awplus(config)# wireless
awplus(config-wireless)# network 1
awplus(config-wireless-network)# passpoint
awplus(config-wireless-network-passpoint)# dot11u
awplus(config-wireless-network-passpoint-dot11u)# qos-map-set
53,2,22,6,8,15,0,7,255,16,31,32,39,255,255,40,47,255,255
```

Related commands [show wireless network](#)
[dot11u \(wireless-network-passpoint\)](#)

Command changes Version 5.5.0-2.3: command added

radio (wireless-ap)

Overview Use this command to enter **wireless-ap-radio** configuration mode.

Syntax radio <1-3>

Parameter	Description
<1-3>	The radio interface.

Mode Wireless AP Configuration

Example To enter the AP Radio configuration mode, use the following commands:

```
awplus# configure terminal
awplus(config)# wireless
awplus(config-wireless)# ap 100
awplus(config-wireless-ap)# radio 2
awplus(config-wireless-ap-radio)#
```

Related commands

ap
show wireless ap
show wireless ap neighbors
show wireless ap client
description (wireless-ap)
power (wireless-ap-radio)
enable (wireless-ap)

Command changes Version 5.4.7-2.4: command added

radio (wireless-ap-profile)

Overview Use this command to enter AP profile radio configuration mode. Once in this mode, you can create and modify the radio configuration parameters for an AP profile.

Syntax radio <1-3>

Parameter	Description
<1-3>	The radio interface within the AP profile.

Mode Wireless AP Profile Configuration

Example To enter the AP profile radio configuration mode for interface 1, use the following commands:

```
awplus# configure terminal
awplus(config)# wireless
awplus(config-wireless)# ap-profile 2
awplus(config-wireless-ap-prof)# radio 1
awplus(config-wireless-ap-prof-radio)#
```

Related commands

[ap-profile \(wireless\)](#)
[show wireless ap-profile](#)
[enable \(wireless-ap-prof-radio\)](#)
[antenna \(wireless-ap-prof-radio\)](#)
[mode \(wireless-ap-prof-radio\)](#)
[bandwidth \(wireless-ap-prof-radio\)](#)
[bandwidth \(wireless-ap-prof-radio\)](#)
[station-isolation enable \(wireless-ap-prof-radio\)](#)
[airtime-fairness enable \(wireless-ap-prof-radio\)](#)
[management-frame-protection enable \(wireless-sec-wpa-psnl\)](#)
[max-clients](#)
[channels \(wireless-ap-prof-radio\)](#)
[vap \(wireless-ap-prof-radio\)](#)

Command changes Version 5.4.7-2.4: command added.

radius accounting enable

Overview Use this command to configure RADIUS accounting on Captive Portal with external RADIUS.

Use the **no** variant of this command to disable RADIUS accounting on Captive Portal.

Syntax radius accounting enable
no radius accounting enable

Default Disabled.

Mode Wireless Network Captive Portal Configuration

Usage notes The server settings used by Captive Portal RADIUS accounting are those configured by the **radius auth group** command. The port number used is the same one set on the primary server by the command **radius-server host**.

Example To configure RADIUS accounting on Captive Portal for network 20, use the commands:

```
awplus# configure terminal
awplus(config)# wireless
awplus(config-wireless)# network 20
awplus(config-wireless-network)# captive-portal
awplus(config-wireless-network-cp)# radius accounting enable
```

Related commands captive-portal virtual-ip
radius accounting enable
radius auth group (wireless-network-cp)

Command changes Version 5.5.0-1.3: command added

radius auth group (wireless-network-cp)

Overview Use this command to set the RADIUS server/s that wireless APs use for Captive Portal (web authentication).

Use the **no** variant of this command to remove the RADIUS server/s used for authentication.

Syntax `radius auth group {radius|<groupname>}`
`no radius auth group {radius|<groupname>}`

Parameter	Description
<code>radius</code>	Use a RADIUS server registered with the radius-server host command.
<code><groupname></code>	Use a RADIUS server that belongs to the specified server group. Use a server group created with the aaa group server radius command.

Default No RADIUS server set by default.

Mode Wireless Network Captive Portal Configuration

Usage notes This setting is only valid for TQ series APs. It has no effect on MWS series APs.

Example To use the RADIUS group 'my_rad' for Captive Portal authentication, use the commands:

```
awplus# configure terminal
awplus(config)# wireless
awplus(config-wireless)# network 20
awplus(config-wireless-network)# captive-portal
awplus(config-wireless-network-cp)# mode radius
awplus(config-wireless-network-cp)# radius auth group my_rad
```

Related commands

[aaa group server](#)
[captive-portal](#)
[enable \(wireless-network-cp\)](#)
[mac-auth password](#)
[mac-auth username](#)
[page-proxy-url](#)
[radius auth group \(wireless-network-cp\)](#)
[radius-server host](#)

redirect-url
session-keep
mode (wireless-network-cp)

Command changes Version 5.4.9-1.1: command added

radius authentication group (wireless-sec-osen)

Overview Use this command to assign a RADIUS server group for authenticating wireless AP clients using the OSEN security mode.

Use the **no** variant of this command to revert to the default RADIUS server group.

Syntax `radius auth group {radius|<group-name>}`
`no radius auth group`

Parameter	Description
<code>radius</code>	Use RADIUS servers.
<code><group-name></code>	Use the RADIUS server group

Default RADIUS.

Mode Wireless Security OSEN Configuration

Usage notes The RADIUS server group is configured with the **aaa group server** command. The group name **radius** is predefined, which includes all RADIUS servers configured by the **radius-server host** command. However, this command, (**radius authentication group**) uses only the first two configured servers.

Example To configure the RADIUS authentication group to authenticate APs using the OSEN security mode, use the commands:

```
awplus# configure terminal
awplus(config)# wireless
awplus(config-wireless)# security 210 mode osen
awplus(config-wireless-sec-osen)# radius authentication group
radius
```

Related commands [radius-server host](#)
[aaa group server](#)

[show wireless security](#)

[security \(wireless\)](#)

Command changes Version 5.5.0-2.3: command added

radius auth group (wireless-sec-wpa-ent)

Overview Use this command to set the RADIUS server group used to authenticate clients in a wireless WPA-enterprise.

Use the **no** variant of this command to set the RADIUS server group to the default.

Syntax radius auth group {radius|<group-name>}
no radius auth group

Parameter	Description
radius	Use all RADIUS servers.
<group-name>	Server group name

Default RADIUS (all RADIUS servers).

Mode Wireless Security WPA-enterprise Configuration

Example To set **radius**, which means all RADIUS servers, to authenticate a wireless WPA-enterprise, use the following commands:

```
awplus# configure terminal
awplus(config)# wireless
awplus(config-wireless)# security 210 mode wpa-enterprise
awplus(config-wireless-sec-wpa-ent)# radius auth group radius
```

Related commands [security \(wireless\)](#)

Command changes Version 5.4.7-2.4: command added

redirect-url

Overview Use this command to enable the redirect-url feature. After successful authentication this feature redirects the web browser to the URL specified in the command. If both [session-keep](#) and **redirect-url** are enabled, session-keep takes precedence.

Use the **no** variant of this command to disable the redirect-url feature.

Syntax `redirect-url <URL>`
`no redirect-url`

Parameter	Description
<URL>	URL of page to redirect the user to (hostname or dotted IP notation).

Default Not set by default.

Mode Wireless Network Captive Portal Configuration

Usage notes This setting is valid only for TQ4400, TQ4600, TQ4400e, TQ1402, TQ5403, TQ5403e, TQm1402, and TQm5403 APs. It has no effect on TQ2450, TQ3200, TQ3400, TQ3600 and MWS series APs.

Example To enable and set the redirect-url for Captive Portal authentication on network 20, use the commands:

```
awplus# configure terminal
awplus(config)# wireless
awplus(config-wireless)# network 20
awplus(config-wireless-network)# captive-portal
awplus(config-wireless-network-cp)# redirect-url
http://www.mydomain.com/welcome
```

Related commands

[captive-portal](#)
[enable \(wireless-network-cp\)](#)
[mac-auth password](#)
[mac-auth username](#)
[page-proxy-url](#)
[radius auth group \(wireless-network-cp\)](#)
[redirect-url](#)
[session-keep](#)
[mode \(wireless-network-cp\)](#)

Command changes Version 5.4.9-1.1: command added

rogue-ap-detection enable (wireless)

Overview Use this command to enable rogue application detection.
Use the **no** variant of this command to disable rogue application detection.

Syntax `rogue-ap-detection enable`
`no rogue-ap-detection enable`

Default Disabled.

Mode Wireless Configuration

Example To enable rogue application detection, use the following commands:

```
awplus# configure terminal
awplus(config)# wireless
awplus(config-wireless)# rogue-ap-detection enable
```

Related commands [show wireless](#)

Command changes Version 5.4.7-2.4 command added.

roaming-oi

(wireless-network-passpoint-dot11u)

Overview Use this command to set the Roaming Consortium List. A Roaming Consortium List contains multiple Organisation Identifiers (OIs) whose security credentials can be used to connect to a network.

Use the **no** variant of this command to revert to the default value.

Syntax `roaming-oi <oi-list>`
`no roaming-oi`

Parameter	Description
<code><oi-list></code>	Roaming Consortium List. <ul style="list-style-type: none">You can have multiple OIs in a listEach OI is between 3 and 15 octets and is configured as a hexadecimal string.Separate OIs with a comma.The maximum number of OIs is 15.The length of a character in the OI-List must be less than 465 including commas.

Default None

Mode Wireless Network Passpoint 802.11u Configuration

Usage notes The Roaming Consortium Element tell a mobile device which roaming consortiums or service providers are available through an AP.

Example To set a Roaming Consortium List containing two OIs, use the commands:

```
awplus# configure terminal
awplus(config)# wireless
awplus(config-wireless)# network 1
awplus(config-wireless-network)# passpoint
awplus(config-wireless-network-passpoint)# dot11u
awplus(config-wireless-network-passpoint-dot11u)# roaming-oi
021122,2233445566
```

Related commands [show wireless network](#)
[dot11u \(wireless-network-passpoint\)](#)

Command changes Version 5.5.0-2.1: command added.

sc-profile

Overview Use this command to add a Smart Connect profile configuration and enter the Smart Connect profile configuration mode.

Use the **no** variant of this command to remove a Smart Connect profile configuration.

Syntax `sc-profile <1-65535>`
`no sc-profile`

Parameter	Description
<code><1-65535></code>	The Smart Connect profile ID.

Default Not set

Mode Wireless AP Profile Configuration

Example To add Smart Connect profile 1 to AP profile 10, use the commands:

```
awplus# configure terminal
awplus(config)# wireless
awplus(config-wireless)# ap-profile 10
awplus(config-wireless-ap-prof)# sc-profile 1
```

Related commands [smart-connect-profile](#)
[show wireless ap-profile](#)
[show wireless network](#)

Command changes Version 5.5.0-0.1: command added

sc-channel

Overview Use this command to set a fixed radio channel for an access point (AP) using Smart Connect.

Use the **no** variant of this command to delete this setting.

Syntax `sc-channel radio <1-3> channel {<channel-number>|auto}`
`no sc-channel`

Parameter	Description
<1-3>	Select the radio channel fixed for AWC-SC use
<channel-number>	Select the radio channel that is defined in the AP profile
auto	The radio channel is automatically selected

Default Not set.

Mode Wireless Smart Connect Profile Configuration

Example To automatically configure the Smart Connect channel with AP profile 10, use the commands:

```
awplus# configure terminal
awplus(config)# wireless
awplus(config-wireless)# smart-connect-profile 10
awplus(config-wireless-sc-prof)# sc-channel radio 2 channel
auto
```

Related commands [smart-connect-profile](#)
[show wireless ap](#)
[show wireless ap-profile](#)

Command changes Version 5.5.0-0.1: command added

security (wireless)

Overview Use this command to configure a wireless security instance and enter a configuration mode. If the instance doesn't already exist, then this command creates it. The command has four different types of configuration mode: OSEN, WEP, WPA-Personal, and WPA-Enterprise.

Use the **no** variant of this command to remove a wireless security instance.

Syntax `security <1-65535> mode {osen|wep|wpa-personal|wpa-enterprise}`
`no security <1-65535>`

Parameter	Description
<1-65535>	Wireless security instance identification number
mode	Security mode
osen	Security mode OSEN. This assigns the configuration identifier to config-wireless-sec-osen mode and enters the mode.
wep	Security mode WEP. This assigns the configuration identifier to config-wireless-sec-wep mode and enters the mode.
wpa-personal	Security mode WPA-Personal. This assigns the configuration identifier to config-wireless-sec-wpa-psnl mode and enters the mode.
wpa-enterprise	Security mode WPA-Enterprise. This assigns the configuration identifier to config-wireless-sec-wpa-ent mode and enters the mode.

Default Not set.

Mode Wireless Configuration

Usage notes You create a wireless security instance by designating a security instance ID and selecting a security mode. There are four types of security modes:

- OSEN
- WEP
- WPA-Personal
- WPA-Enterprise

Example To configure and enter the wireless security mode for WPA-Personal, use the following commands:

```
awplus# configure terminal
awplus(config)# wireless
awplus(config-wireless)# security 10 mode wpa-personal
awplus(config-wireless-sec-wpa-psnl)#
```

Related commands

wireless
security (wireless-network)
enable (wireless-sec-wep)
authentication (wireless-sec-wep)
type (wireless-sec-wep)
length (wireless-sec-wep)
index
show wireless security

Command changes

Version 5.4.7-2.4: command added
Version 5.5.0-2.3: **osen** parameter added

security (wireless-network)

Overview Use this command to designate a security configuration identifier for a wireless security configuration.
Use the **no** variant of this command to remove a security configuration identifier.

Syntax `security <1-65535>`
`no security`

Parameter	Description
<code><1-65535></code>	The wireless security configuration identifier.

Default Not set.

Mode Wireless Network Configuration

Example To assign a security configuration identifier of 10 to wireless network 2, use the following commands:

```
awplus# configure terminal
awplus(config)# wireless
awplus(config-wireless)# network 2
awplus(config-wireless-network)# security 10
```

Related commands [network \(wireless\)](#)
[show wireless network](#)

Command changes Version 5.4.7-2.4: command added.

security (wireless-wds)

Overview Use this command to set a wireless security configuration identifier to the WDS configuration mode.

Use the **no** variant of this command to remove the WDS security configuration identifier.

Syntax `security <1-65535>`
`no security`

Parameter	Description
<1-65535>	The wireless security configuration identifier.

Default Not set.

Mode Wireless WDS Configuration

Example To designate the wireless security configuration identifier to the WDS configuration, use the following commands:

```
awplus# configure terminal
awplus(config)# wireless
awplus(config-wireless)# wds 10
awplus(config-wireless-wds)# security 2
```

Related commands [wds](#)
[show wireless wds](#)

Command changes Version 5.4.7-2.4: command added

service wireless

Overview Use this command to enable wireless services.
Use the **no** version of the command to disable unused wireless services.

Syntax `service wireless`
`no service wireless`

Default Enabled

Mode Global Configuration

Usage notes On devices that support the wireless manage feature, sometimes it may be desirable to disable unused services, in order to reduce memory use. Disabling the wireless services will only take effect after you save the configuration and restart the device.

Example To disable the wireless service, use the commands:

```
awplus# configure terminal
awplus(config)# no service wireless
```

Output Figure 52-1: Example output from **no service wireless**

```
awplus(config)#no service wireless
% Save the config and restart the device for this change to take
effect
```

Command changes Version 5.5.0-0.1: command added

session-keep

Overview Use this command to enable the session-keep feature. After successful authentication this feature redirects the web browser back to the originally requested URL. If both **session-keep** and [redirect-url](#) are enabled, session-keep takes precedence.

Use the **no** variant of this command to disable the session-keep feature.

Syntax `session-keep`
`no session-keep`

Default Not set by default.

Mode Wireless Network Captive Portal Configuration

Usage notes This setting is valid only for TQ4400, TQ4600, TQ4400e, TQ1402, TQ5403, TQ5403e, TQm1402, and TQm5403 APs. It has no effect on TQ2450, TQ3200, TQ3400, TQ3600 and MWS series APs.

Example To configure session-keep for Captive Portal authentication on network 20, use the commands:

```
awplus# configure terminal
awplus(config)# wireless
awplus(config-wireless)# network 20
awplus(config-wireless-network)# captive-portal
awplus(config-wireless-network-cp)# session-keep
```

Related commands

- [captive-portal](#)
- [enable \(wireless-network-cp\)](#)
- [mac-auth password](#)
- [mac-auth username](#)
- [page-proxy-url](#)
- [radius auth group \(wireless-network-cp\)](#)
- [redirect-url](#)
- [session-keep](#)
- [mode \(wireless-network-cp\)](#)

Command changes Version 5.4.9-1.1: command added

session-key-refresh-action

Overview Use this command to set the action after the interval has expired for the session key used in a WPA-enterprise security configuration.

Use the **no** variant of this command to revert to the default action.

Syntax `session-key-refresh-action {reauthentication|disconnection}`
`no session-key-refresh-action`

Parameter	Description
<code>reauthentication</code>	The client will be asked to re-authenticate after the session expires.
<code>disconnection</code>	The client will be disconnected when the session expires.

Default Reauthentication.

Mode Wireless Security WPA-enterprise Configuration

Usage notes This command will not work if the **session-key-refresh-interval** command is set to a non-zero value.

Example For a WPA-enterprise configuration, to set disconnect as the action after the expire session-key refresh interval, use the commands:

```
awplus# configure terminal
awplus(config)# wireless
awplus(config-wireless)# security 100 mode wpa-enterprise
awplus(config-wireless-sec-wpa-ent)#
session-key-refresh-action disconnection
```

Related commands [show wireless security](#)
[session-key-refresh-interval](#)

Command changes Version 5.5.1-2.1: command added

session-key-refresh-interval

Overview Use this command to set the refresh interval for the session key used in a WPA-enterprise security configuration.
Use the **no** variant of this command to set the refresh interval to the default.

Syntax `session-key-refresh-interval <0-86400>`
`no session-refresh-key-interval`

Parameter	Description
<code><0-86400></code>	The refresh interval in seconds.

Default The default refresh interval is 0 seconds.

Mode Wireless Security WPA-enterprise Configuration

Usage notes This command is for TQ series devices only.

Example To set 7200 seconds as the session key refresh rate, use the following commands:

```
awplus# configure terminal
awplus(config)# wireless
awplus(config-wireless)# security 210 mode wpa-enterprise
awplus(config-wireless-sec-wep-ent)#
session-key-refresh-interval 7200
```

Related commands [security \(wireless\)](#)
[session-timeout-interval \(wireless network-cp\)](#)

Command changes Version 5.4.7-2.4: command added

session-timeout-action (wireless network-cp)

Overview Use this command to limit the connection time for clients on a Captive Portal session. When the session times-out, the client will either be presented with the authentication page or be disconnected.

Use the **no** variant of this command to revert to the default action.

Syntax `session-timeout-action {reauthentication|disconnection}`
`no session-timeout-action`

Parameter	Description
<code>reauthentication</code>	The client must re-authenticate before continuing to use the Captive Portal session.
<code>disconnection</code>	The client will be disconnected when the Captive Portal session expires. The client can decide whether or not to go through the process of re-authentication.

Default Reauthentication.

Mode Wireless Network Captive Portal Configuration

Usage notes This command will not work if the **session-timeout-interval** command is set to a non-zero value.

Example To disconnect an AP after its Captive Portal session has expired, use the commands:

```
awplus# configure terminal
awplus(config)# wireless
awplus(config-wireless)# network 100
awplus(config-wireless-network)# captive-portal
awplus(config-wireless-network-cp)# session-timeout-action
disconnection
```

Related commands [show wireless network](#)
[session-timeout-interval \(wireless network-cp\)](#)

Command changes Version 5.5.1-2.1: command added

session-timeout-interval (wireless network-cp)

Overview Use this command to set the session-timeout-interval for authenticated clients in a Captive Portal configuration.

Use the **no** variant of this command to revert to the default session-timeout-interval value.

Syntax `session-timeout-interval <0-86400>`
`no session-timeout-interval`

Parameter	Description
<code><0-86400></code>	The session-timeout-interval value in seconds. To disable the timeout function, set a value of '0' seconds.

Default 3600 seconds.

Mode Wireless Network Captive Portal Configuration

Example To configure a session-timeout-interval of 1800 seconds, use the commands:

```
awplus# configure terminal
awplus(config)# wireless
awplus(config-wireless)# network 100
awplus(config-wireless-network)# captive-portal
awplus(config-wireless-network-cp)# session-timeout-interval
1800
```

Related commands [show wireless network](#)
[session-timeout-action \(wireless network-cp\)](#)
[session-key-refresh-interval](#)

Command changes Version 5.5.1-2.1: command added

show debugging wireless

Overview Use this command to see what debugging is turned on for wireless management. For information on filtering and saving command output, see the [“Getting Started with AlliedWare Plus” Feature Overview and Configuration Guide](#).

Syntax `show debugging wireless`

Mode User Exec and Privileged Exec

Example `awplus# show debugging wireless`

Output Figure 52-2: Example output from the **show debugging wireless** command

```
awplus#show debugging wireless
Wireless debugging is on
Wireless all modules debugging is on
Wireless warning level debugging is on
```

Related commands [show wireless](#)

show wireless

Overview Use this command to show the overall status information for Autonomous Wave Control (AWC).

Syntax show wireless

Mode Privileged Exec

Example To show the status of AWC on a device, use the command:

```
awplus# show wireless
```

Output Figure 52-3: Example output from **show wireless**

```
awplus> show wireless
Wireless Controller Mode ..... Enable
Management IP Address ..... 192.168.8.30
Rogue AP Detection ..... Enable
Neighbor Managed AP Detection ... Enable
Emergency Mode ..... Activate
  Activated User ..... Emergency USB by Example Key1
  Activated Time ..... 2022-04-27 12:11:36
Emergency USB trigger ..... Enable
  Trigger Key1 ..... Example Key1
  Description ..... ABC School USB1
  Trigger Key2 ..... Example Key2
  Description ..... ABC School USB2
Log ..... Disable
Log Destination .....
Log Size Wireless Client ..... 50
Log Rotate Wireless Client ..... 1
Log Rotate neighbor AP ..... 1
Log Interval neighbor AP ..... 30
```

In this example, emergency mode can be triggered by inserting either of two pre-prepared USB sticks into the AlliedWare Plus device.

Related commands [management address](#)
[enable \(wireless\)](#)
[rogue-ap-detection enable \(wireless\)](#)
[log enable destination](#)

Command changes Version 5.4.7-2.4: command added.

show wireless ap

Overview Use this command to display the configuration and status of wireless Access Points (APs).

Syntax `show wireless ap {<ap-id-range>|all} [brief|status|detail]`

Parameter	Description
<ap-id-range>	Display the configuration and status for a selected AP or range of APs, <1-65535>.
all	Display the configuration and status of APs.
brief	Display the brief configuration details of APs.
status	Display the status of APs.
detail	Display the detailed status and device information of APs.

Mode Privileged Exec

Example To display the status and configuration of wireless APs, use the following commands:

```
awplus# show wireless ap
```

Output Figure 52-4: Example output from **show wireless ap**

```
awplus#show wireless ap
AP ID 1:
  Status ..... Enable
  Description ..... TQ5403
  AP Profile ..... 3
  IP Address ..... 192.0.2.13
  MAC Address ..... 0000.5e00.5301
  Login Username ..... manager
  Login Password ..... friend
Radio 1:
  OverrideRadioStatus .....
  Status ..... Enable
  Channel ..... 1,6,11
  Power ..... 50
Radio 2:
  OverrideRadioStatus .....
  Status ..... Enable
  Channel ..... Auto
  Power ..... Auto
```

```
AP ID 2:
Status ..... Enable
Description ..... TQ6602
AP Profile ..... 20
IP Address ..... 198.51.100.100
MAC Address ..... 0000.5e00.5312
Login Username ..... manager
Login Password ..... friend
Radio 1:
  OverrideRadioStatus .....
  Status ..... Disable
  Channel ..... auto
  Power ..... auto
Radio 2:
  OverrideRadioStatus .....
  Status ..... Enable
  Channel ..... 48
  Power ..... 60
AP ID 3:
Status ..... Enable
Description ..... TQ6602G2
AP Profile ..... 100
IP Address ..... 198.51.100.200
MAC Address ..... 0000.5e00.5344
Login Username ..... manager
Login Password ..... friend
Radio 1:
  OverrideRadioStatus .....
  Status ..... Enable
  Channel ..... 1,6,12
  Power ..... 30
Radio 2:
  OverrideRadioStatus .....
  Status ..... Enable
  Channel ..... 52
  Power ..... 100
AP ID 4:
Status ..... Enable
Description ..... TQ6702G2
AP Profile ..... 500
IP Address ..... 203.0.113.100
MAC Address ..... 889d.9812.197f
Login Username ..... manager
Login Password ..... friend
Radio 1:
  OverrideRadioStatus .....
  Status ..... Enable
  Channel ..... auto
  Power ..... auto
Radio 2:
  OverrideRadioStatus .....
  Status ..... Enable
  Channel ..... auto
  Second Channel ..... 44
  Power ..... auto
```

To display a brief (summary), use the following command:

```
awplus# show wireless ap brief
```

Figure 52-5: Example output from **show wireless ap brief**

```
awplus#show wireless ap brief
```

ID	Description	Status	Prof	IP Address	MAC Address
1	TQ5403	Enable	3	192.0.2.13	0000.5e00.5301
2	TQ6602	Enable	20	198.51.100.100	0000.5e00.5312
3	TQ6602G2	Enable	100	198.51.100.200	0000.5e00.5344

```
awplus#  
Legends:  
- ID          ... ID of Access Point entry  
- Model       ... Description of Access Point  
- Status      ... Status of AP configuration  
- IP Address  ... IP Address of Access Point  
- MAC Address ... MAC Address of Access Point
```

To display AP status, use the following command:

```
awplus# show wireless ap status
```

Figure 52-6: Example output from **show wireless ap status**

```
awplus#show wireless ap status
ID      Model      FW ver  Manage rupt Config  c  Clnt  Uptime
-----
1 AT-TQ5403    6.0.2-0.1  Managd ---- Succeed - 0  848048
2 AT-TQ6602    7.0.1-2.2  Managd ---- Succeed - 0  520317
3 AT-TQ6602 GEN2 8.0.1-0.1  Managd ---- Succeed - 0  65556
4 AT-TQ6702 GEN2 8.0.0-0.1  Managd ---- Succeed - 0  161036

awplus#
Legends:
- ID      ... ID of Access Point entry
- Model   ... Model name of Access Point
- FW ver  ... Firmware version of Access Point
- Manage  ... Management Status of Access Point
           Managd: Managed
           Discvd: Discovered
           Joined: Joinded
           Failed: Failed
           Reboot: Rebooting
           Update: Updating
- r       ... Reboot Status
           R: Requested
           *: Rebooting
           S: Succeeded
           F: Failed
- u       ... Update Status
           R: Requested
           *: Upgrading
           S: Succeeded
           F: Failed
- p       ... Power-Channel Status
           R: Requested
           S: Succeeded
           F: Failed
- t       ... Technical support file collecting Status
           R: Requested
           E: Executing
           S: Succeeded
           F: Failed (includes aborted)
- Config  ... Configuration Status
           NotConfig: Not Configured
           InProgrs: In Progress
           Succeed : Succeeded
           Failed  : Failed
           Unknown : Unknown
- c       ... Configuration Apply Status
           R: Requested
           A: Applying
           S: Succeeded
           F: Failed
- Clnt    ... Number of connected clients
- Uptime  ... Uptime in seconds
```

To display AP detail, use the following command:

```
awplus# show wireless ap detail
```

Figure 52-7: Example output from **show wireless ap detail**

```
awplus#show wireless ap detail
AP ID 1:
Description ..... TQ5403
AP Profile ..... 3
IP Address ..... 192.0.2.13
MAC Address ..... 0000.5e00.5301
Model ..... AT-TQ5403
Serial .....
Firmware Version ..... 6.0.2-0.1
Management Status ..... Joined
Configuration Status ..... In Progress (Modified)
Crash Log Status ..... -
Clients..... 0
Sysup time..... 0
Operational Status:
  Reboot Status ..... -
  Firmware Upgrade Status ..... -
  Configuration Apply Status .... -
  Auto Channel Power Status ..... -
Radio 1:
  Channel ..... 5
  Power ..... 10
  Radar detection ..... None
Radio 2:
  Channel ..... 40
  Power ..... 100
  Radar detection ..... None
```



```
AP ID 2:
Description ..... TQ6602
AP Profile ..... 20
IP Address ..... 198.51.100.100
MAC Address ..... 0000.5e00.5312
Model ..... AT-TQ6602
Serial .....
Firmware Version ..... 7.0.1-2.2
Management Status ..... Managed
Configuration Status ..... Succeeded (Latest)
Crash Log Status ..... -
Clients..... 0
Sysup time..... 0
Operational Status:
  Reboot Status ..... -
  Firmware Upgrade Status ..... -
  Configuration Apply Status .... -
  Auto Channel Power Status ..... -
Radio 1:
  Channel ..... 1
  Power ..... 100
  Radar detection ..... None
Radio 2:
  Channel ..... 36
  Power ..... 100
  Radar detection ..... None
AP ID 3:
Description ..... TQ6602G2
AP Profile ..... 100
IP Address ..... 198.51.100.200
MAC Address ..... 0000.5e00.5344
Model ..... AT-TQ6602 GEN2
Serial .....
Firmware Version ..... 8.0.1-0.1
Management Status ..... Managed
Configuration Status ..... Succeeded (Latest)
Crash Log Status ..... -
Clients..... 0
Sysup time..... 0
Operational Status:
  Reboot Status ..... -
  Firmware Upgrade Status ..... -
  Configuration Apply Status .... -
  Auto Channel Power Status ..... -
Radio 1:
  Channel ..... 1
  Power ..... 100
  Radar detection ..... None
Radio 2:
  Channel ..... 36
  Power ..... 100
  Radar detection ..... None
```

```
AP ID 4:
Description ..... TQ6702G2
AP Profile ..... 500
IP Address ..... 192.8.20.100
MAC Address ..... 203.0.113.100
Model ..... AT-TQ6702 GEN2
Serial .....
Firmware Version ..... 8.0.0-0.1
Management Status ..... Managed
Configuration Status ..... Succeeded (Latest)
Crash Log Status ..... -
Clients..... 0
Sysup time..... 0
Operational Status:
  Reboot Status ..... -
  Firmware Upgrade Status ..... -
  Configuration Apply Status .... -
  Auto Channel Power Status ..... -
Radio 1:
  Channel ..... 1
  Power ..... 100
  Radar detection ..... None
Radio 2:
  Channel ..... 36
  Power ..... 100
  Radar detection ..... None
```

Related commands

- [enable \(wireless-ap\)](#)
- [ap-profile \(wireless\)](#)
- [description \(wireless-ap\)](#)
- [ip-address \(wireless-ap\)](#)
- [radio \(wireless-ap-profile\)](#)
- [channels \(wireless-ap-prof-radio\)](#)
- [login username \(wireless-ap\)](#)
- [login-password \(wireless-ap\)](#)
- [wds radio \(wireless-ap\)](#)
- [description \(wireless-ap\)](#)
- [wireless get-tech ap](#)
- [wireless get-tech ap-profile](#)
- [wireless get-tech sc-profile](#)

Command changes

Version 5.4.7-2.4: command added.

show wireless ap capability

Overview Use this command to display the configured specifications of a supported wireless Access Point (AP).

Syntax `show wireless ap capability`
`show wireless ap capability hwtype <modelname>`
`show wireless ap capability hwtype {tq|mws}`
`[single|dual|triple] [spec {11ac|11n}] [radio {1|2|3}] [country`
`<country-code>]`

Parameter	Description
hwtype	To specify the display of a hardware type. When omitted, all hardware types will be displayed.
<modelname>	The model name of the wireless AP capabilities to be displayed. See hwtype for a full list of model names.
tq	Display hardware type AT-TQ series only.
mws	Display hardware type AT-MWS series only.
single	Display a single radio interface.
dual	Display a dual radio interface.
spec	To specify the display of an IEEE wireless networking standard mode. When omitted, all modes are displayed.
11ac	Display information for the 802.11ac mode only.
11n	Display information for the 802.11n mode only.
radio	To specify a radio bandwidth. When omitted, all radio bandwidths are displayed.
1	Display information for radio bandwidth 2.4GHz only.
2	Display information for radio 2 bandwidth 5GHz only.
3	Display information for radio 3 bandwidth 5GHz only.
country	To specify the display for a country. When omitted, the default country will be displayed.
<country-code>	Display the specified country code. The default country code is 'jp' for Japan or 'us' for other regions.

Mode User Exec and Privileged Exec

Output Figure 52-8: Example output from **show wireless ap capability**

```
awplus#show wireless ap capability
Country: jp
Hwtype Radios Spec Band Radio Mode Bandwidths
-----
tq      dual  11ac - 1   bg      20
        *bg-n  20, 40
        n-only-g 20, 40
        2   a      20
        *a-n-ac 20, 40, 80
        n-ac   20, 40, 80
        11n - 1   bg      20
        *bg-n  20, 40
        n-only-g 20, 40
        2   a      20
        *a-n   20, 40
        n-only-a 20, 40
        single 11n 2   1   bg      20
        *bg-n  20, 40
        n-only-g 20, 4
        5   1   a      20
        *a-n   20, 40
        n-only-a 20, 40
mws     dual  11ac - 1   bg      20
        *bg-n  20, 40
        n-only-g 20, 40
        2   a      20
        *n-ac  20, 40, 80
        11n - 1   bg      20
        *bg-n  20, 40
        n-only-g 20, 40
        2   a      20
        *a-n   20, 40
        n-only-a 20, 40
* means default configuration
```

Related commands [country-code](#)
[show wireless country-code](#)
[hwtype](#)

Command changes Version 5.4.7-2.4: command added.
 Version 5.4.9-1.1: <modelname> parameter added.

show wireless ap client

Overview Use this command to display the client information on a managed wireless Access Point (AP).

Syntax `show wireless ap [<ap-id-range>] client [radio <1-3>]`

Parameter	Description
<i><ap-id-range></i>	Display information for the selected Access Point, or range <i><1-65535></i> .
radio	Select a radio interface on the AP.
<i><1-3></i>	Radio interface number.

Mode User Exec and Privileged Exec

Example To display the wireless AP client settings, use the following commands:

```
awplus# show wireless ap client
```

Output Figure 52-9: Example output from **show wireless ap client**

```
awplus#show wireless ap client
```

IP Address	Mac Address	AP	SSID	Radio	Ch	Signal	Age
192.168.10.100	1234.abcd.5678	1	4z9FbaEh2Vr	2	36	58	00d:00h:05m:21s
192.168.10.103	1234.abef.9876	3	prTn044aN7H	1	12	11	05d:15h:13m:40s

Related commands [radio \(wireless-ap\)](#)

Command changes Version 5.4.7-2.4: command added

show wireless ap neighbors

Overview Use this command to display the neighboring wireless Access Points (APs) connected to a radio or range of radios. If no parameters are specified, then all configurations are displayed.

Syntax `show wireless ap [<ap-id-range>|all] neighbors [radio <1-3>]`

Parameter	Description
<i><ap-id-range></i>	Show the radio and wireless neighbors associated with an AP or range of APs. To select a range, use the range format <i><1-65535></i> .
all	Display the radio and neighbors for all APs.
radio	Display the configured radio.
<i><1-3></i>	Radio interface number.

Mode User Exec and Privileged Exec

Usage notes If the total number of AP neighbors in the system exceeds 12500, this command will only show the first 12500 neighbors. You can specify the AP ID to see all neighbors of each AP.

Example To display all wireless AP neighbors, use the following command:

```
awplus# show wireless ap neighbors
```

Output Figure 52-10: Example output from **show wireless ap neighbors**

```
awplus#show wireless ap neighbors
```

BSSID	ESSID	R	Ch	Sig	AP	Detected
001a.ebab.ced0	meeting-space1	2	124	19	1	2017-09-07 07:27:11
001a.ebab.ced2	meeting-space2	2	124	19	1	2017-09-07 07:27:11
5001.d93a.e654	office	2	116	12	1	2017-09-07 07:25:08
1234.5610.0270	guest	2	124	9	1	2017-09-07 07:25:14
001a.eb84.5750	Demo	2	140	14	1	2017-09-07 07:10:08
001a.eb71.9594	Web	2	48	25	1	2017-09-07 06:55:06
001a.eb71.9595	test1	2	48	26	1	2017-09-07 06:55:06
104b.4683.46b7	test2	2	52	8	1	2017-09-07 06:37:03
001a.ebbe.d3b0	test3	2	36	66	1	2017-09-07 06:33:02

Related commands [radio \(wireless-ap\)](#)

Command changes Version 5.4.7-2.4: command added.
Version 5.4.8-1.1: display limited to 12500 neighbors

show wireless ap power-channel

Overview Use this command to display the currently configured status of an Access Point (AP) power-channel. If the command parameters are omitted, then the status for all APs will display.

Syntax `show wireless ap [<ap-id-range>|all] power-channel`

Parameter	Description
<ap-id-range>	Display the current power-channel status for a selected AP or range of APs in the format <1-65535>
all	Display the current power-channel status for all APs.

Mode User Exec and Privileged Exec

Example To display the currently configured power-channel status for APs, use the command:

```
awplus# show wireless ap power-channel
```

Output Figure 52-11: Example output from **show wireless ap power-channel**

```
awplus#show wireless ap power-channel
AP      MAC address      Radio1          Radio2
-----
1       001a.ebbc.0200   Ch:120 (100%) -
```

Related commands

- [type power-channel ap all](#)
- [wireless power-channel ap all](#)
- [show wireless power-channel calculate](#)

Command changes Version 5.4.7-2.4: command added.

show wireless ap-profile

Overview Use this command to display the AP-profile configuration for Autonomous Wave Control.

Syntax `show wireless ap-profile [<ap-profile-id-range>|all] [brief]`

Parameter	Description
<code><ap-profile-id-range></code>	Displays the AP-profile information for an ID range. The ID range is <1-65535>.
<code>all</code>	Displays all AP-profile configurations.
<code>brief</code>	Displays a brief summary of AP-profile configurations.

Mode User Exec and Privileged Exec

Output Figure 52-12: Example output from **show wireless ap-profile brief**

```
awplus#show wireless ap-profile brief
```

ID	Description	HWTYPE	Radio 1	Radio 2	Radio 3
1	TQ5403	tq-triple-11n	Disable	Enable	Disable
2	TQ4400e_out	tq-dual-11ac	Enable	Enable	Disable
3	TQ6602	at-tq6602	Disable	Disable	Disable
4	TQ5403e	at-tq5403e	Enable	Enable	Enable

Output Figure 52-13: Example output from **show wireless ap-profile**

```
awplus#show wireless ap-profile

AP-PROFILE ID 1:
Description ..... TQ5403
Country-Code ..... JP
HWTYPE ..... TQ
  Band..... Triple
  Spec ..... 11ac
Band ..... 5GHz
NTP Server ..... Enable
  IP address/Host .....192.168.1.100
  Period..... 30
SNMP ..... Enable
  Version ..... v1v2c
  Port ..... 161
  Read-only community string ... public
  Trap community string ..... private
  Permit host ..... 192.168.1.1/24
Trap host(s):
  Host 1 ..... 192.168.1.10
  Host 2 ..... manager.your.domain.com
Generated Traps:
  Cold Start Traps ..... Enabled
  Link Traps ..... Enabled
  Authentication Traps ..... Enabled
  Association Traps ..... Disabled
  Filtered STA Traps ..... Disabled
  Radius Auth Success Traps ... Disabled
  Radius Auth Failure Traps ... Disabled
  DFS Traps ..... Disabled
LED ..... Enable
Initialization-button ..... Enable
Port-Cascade ..... Enable
Link-Aggregation ..... Disable
LACP ..... Disable
Wireless MAC filter ..... 10
  Rule ..... Permit
Files
  File 1:Name .....sample.png
  File 2:Name .....sample2.png
Captive Portal
  Virtual IP Adress ..... 192.168.100.100
Channel-Blanket
  Control VLAN ..... 100
  Key ..... a4kPHrm-3mA$a.9s
  Bcast Key Refresh Interval ... 0
  Station Isolation ..... Disable
  Beacon RSSI Threshold ..... 0
  CB Proxy ARP ..... Disable
CB Channel
  Radio 1 ..... 1
  Radio 2 ..... 36
  Radio 3 .....
Smart Connect Profile ..... 10
```

```
Radio 1:
  Status ..... Enable
  Mode ..... bg-n
  Bandwidth .....
  Station-Isolation ..... Disable
  Airtime-Fairness ..... Disable
  Max-Clients ..... 200
  Channel ..... 1-13
  Neighbor AP Detection ..... Enable
  Legacy Rates ..... 54,36,24,18,12,11,9,6,5.5,2,1
  MU-MIMO ..... disable
  OFDMA ..... disable
  Zero Wait DFS ..... disable
  VAP ..... 0
  Network ..... 9
  Channel Blanket ..... Yes
  BSSID ..... 00:1a:eb:6a:22:b3
  Smart Connect ..... Yes
Radio 2:
  Status ..... Enable
  Mode ..... a-n
  Bandwidth ..... 40
  Station-Isolation ..... Disable
  Airtime-Fairness ..... Disable
  Max-Clients ..... 20
  Channel ..... 34,38,42,46
  Neighbor AP Detection ..... Disable
  Legacy Rates ..... 54,48,36,24,12,9,6
  MU-MIMO ..... enable
  OFDMA ..... enable
  Zero Wait DFS ..... enable
  VAP ..... 0
  Network ..... 10
  Channel Blanket ..... No
  Smart Connect ..... No
  VAP ..... 2
  Network ..... 20
  Channel Blanket ..... No
  Smart Connect ..... No
```

- Related commands**
- [ap-profile \(wireless\)](#)
 - [description \(wireless-ap-prof\)](#)
 - [country-code](#)
 - [hwtype](#)
 - [band](#)
 - [outdoor](#)
 - [ntp designated-server](#)
 - [led enable](#)
 - [initialization-button enable](#)
 - [radio \(wireless-ap-profile\)](#)

captive-portal virtual-ip

Command changes Version 5.4.7-2.4: command added

show wireless auto-config

Overview Use this command to display operational status for automatically configured wireless networks, profiles and APs.

Syntax show wireless auto-config

Mode Privileged Exec

Example To display current information about an automatic configuration session, use the command:

```
awplus# show wireless auto-config
```

Output Figure 52-14: Example output from **show wireless auto-config**

```
awplus#show wireless auto-config
Last Time executed: 2018-2-26 13:05:26
Last Time updated: 2018-2-26 13:07:33
AP-Profile: 10
Country-code: Not set
Status: Creating configuration

IP Address      MAC Address      Hwtype          AP    Prof  Status
-----
192.168.120.117 0067.5ebb.92c4   tq-single-11n   -    -    NoMatch
192.168.120.113 0067.5e00.5301   tq-dual-11ac    -    -    Collected
192.168.120.133 0067.5e42.a451   tq-dual-11ac    20   10   Modify
192.168.120.121 0067.5e20.ac94   tq-dual-11ac    -    -    Collected
192.168.120.115 0067.5eac.606f   tq-dual-11ac    -    -    Awaiting
```

Table 52-1: Parameters in the output from **command name**

Parameter	Description
Last Time executed	The time that the wireless automatic configuration was last executed.
Last Time updated	The time that any AP status was last updated.
auto-config Time-out	The time that an automatic configuration session timed out. If the wireless controller completed a session before timing out, then it will show this time.
AP-Profile	Specified AP Profile ID for new configurations, or new profile ID of an automatically created one.
Country-code	This is a specified two letter code representing the country for the AP profile. If no country is specified then it appears as "Not set".

Table 52-1: Parameters in the output from **command name** (cont.)

Parameter	Description
Status	<p>Initialized: Wireless automatic discovery of AP list started.</p> <p>In Progress: Discovery AP list achieved, now collecting data and creating configuration.</p> <p>IP Modifying: Modifying IP address after creating another configuration (this status is brief in time).</p> <p>Completed: All configuration is finished successfully.</p> <p>Aborted: Automatic configuration process was stopped using the command wireless auto-config abort.</p> <p>Failed: Wireless automatic configuration failed, for example "Failed to set profile to discovered AP".</p>
IP Address	Discovered wireless access point IP address.
MAC Address	Discovered wireless access point MAC address.
Hwtype	Discovered wireless access point hardware type.
AP	AP configuration for discovered wireless access points.
Prof	AP profile that attach to discovered wireless access points.
Status	<p>Discovered wireless access points status:</p> <p>Awaiting: Waiting for completion of collecting the data.</p> <p>Modify: AP MAC address already exists. It will modify the IP address.</p> <p>Skip: Already configured AP MAC address and IP address, so will do nothing.</p> <p>Done: Successful retrieval of hardware type (model name) and configuration created.</p> <p>NoMatch: hardware type of specified AP profile did not match.</p> <p>NoResp: Centralized Wireless Manager (CWM) Agent(AP) did not respond.</p> <p>Failed: Failed to create configuration, for example "failed to create network %d".</p>

Related commands wireless auto-config

Command changes Version 5.4.8-1.1: command added

show wireless captive-portal network walled-garden

Overview Use this command to display wireless network walled garden entries for Captive Portal.

Syntax `show wireless captive-portal {<network-ID>|all} walled-garden`

Parameter	Description
<network-ID>	Display output for the specified wireless network ID or range of network IDs, valid network IDs are <1- 65535>.
all	Display all wireless network walled garden entries.

Mode Privileged Exec

Example To display the walled garden entries for Captive Portal on network 5, use the commands:

```
awplus# show wireless captive-portal network 5 walled-garden
```

Output Figure 52-15: Example output from **show wireless captive-portal network 5 walled-garden**

```
awplus#show wireless captive-portal network 5 walled-garden
WALLED GARDEN LIST FOR NETWORK ID 5:
Entries ..... 3
  Walled Garden
  -----
  example.com
  1.1.1.1
  1.1.1.0/24
```

Related commands [captive-portal virtual-ip](#)
[walled-garden entry](#)

Command changes Version 5.5.0-1.3: command added

show wireless country-code

Overview Use this command to display a list of country codes that can be used on an Access Point (AP) Autonomous Wave Control (AWC) configuration.

Syntax `show wireless county-code`

Mode User Exec and Privileged Exec

Example To display the list of AWC country codes, use the command:

```
awplus# show wireless country-code
```

Output Figure 52-16: Example output extract from **show wireless country-code**

```
awplus#show wireless country-code
Code  Country
-----
AD    Andorra
AE    United Arab Emirates
AF    Afghanistan
AG    Antigua and Barbuda
AI    Anguilla
AL    Albania
AM    Armenia
AN    Netherlands Antilles
AO    Angola
AR    Argentina
AS    American Somoa
AT    Austria
AU    Australia
AW    Aruba
AZ    Azerbaijan
.....
```

Related commands [show wireless ap capability](#)
[country-code](#)

Command changes Version 5.4.7-2.4: command added.

show wireless network

Overview Use this command to display the wireless network configuration for Autonomous Wave Control (AWC).

If you use the **brief** parameter, a summary of the configuration will be displayed, otherwise a detailed version is displayed.

Syntax `show wireless network [<network-id-range>|all] [brief]`

Parameter	Description
<network-id-range>	Display the network configuration for a selected network ID or network ID range <1-65535>.
all	Display the configuration for all wireless networks.
brief	Display a brief summary of the network configuration.

Mode User Exec

Example To display the brief wireless network configuration, use the command:

```
awplus# show wireless network brief
```

Output Figure 52-17: Example output from **show wireless network brief**

```
awplus#show wireless network brief
```

ID	VLAN	SSID	H	E	Sec ID	MAC-Auth	Web-Auth
1	1	Guest Network	Y	Y	1	-	-
2	2	Default-2	-	-	2	-	Y
3	10	Default-3	-	-	3	-	Y
4	1	Default-4	-	Y	4	-	-
5	1	Default-5	Y	-	5	-	-

Output Figure 52-18: Example output from **show wireless network**

```
awplus#show wireless network
Network ID 1:
  Description ..... Guest Network 1
  Assigned VLAN ID ..... 20
  SSID ..... w3antgihm92ssbp2
  Hide SSID ..... Yes
  Emergency Mode ..... Enable
  Wireless Trigger ID ..... 0
  Band-Steering ..... Disable
  Association Advertisement ..... Disable
  Duplicate AUTH Received ..... Disconnect
  DTIM Period ..... 1
  Proxy ARP ..... Disable
  BSS Transition Management ..... Disable
  Security ID ..... 2
  Security Mode ..... wpa-enterprise
MAC-Auth
  RADIUS group .....
  Username
  Separator ..... colon
  Character Case ..... upper-case
  Password .....
  RADIUS group for Web-Auth .....
  Wireless MAC filter ..... Enable
  Captive portal ..... Enable
  Mode ..... click-through
  RADIUS group .....
  RADIUS Accounting..... Disable
  External Page URL .....
  Redirect URL .....
  Session keep ..... Enable
  Session Timeout Interval ..... 7200
  Session Timeout Action ..... Disconnection
  Page proxy URL .....
  Walled Garden Entries ..... 0
```

```
Passpoint ..... Enable
802.11u
  Access Network Type ..... public
  Internet Access ..... Enable
  Additional Step Required .... Enable
  ES Reacheable ..... Enable
  Unauth ES Accessible ..... Enable
  Venue Group ..... 7
  Venue Type ..... 1
  Homogeneous ESSID ..... 1234.5678.9abc
  Roaming Consortium List ..... 021122,02233445566
  Venue Name Information
    ID 1:
      Language Code ..... jpn
      Venue Name ..... Example venue1
    ID 2:
      Language Code ..... eng
      Venue Name ..... Example venue2Network Auth Type
      Auth Type ..... redirect-http-https
      Redirect URL .....
      http://www.example.com/redirect/me/here
  IP Type Availability v4/v6 .. public/no-exist
  Domain Name ..... example.com,google.com
  3GPP Info (MCC,MNC) ..... 244,91;310,261
  NAI Realm Information
    ID 1:
      Realm Name ..... example.com,example.net
      EAP Method ..... EAP-TLS
    ID 2:
      Realm Name ..... example.com;example.net
      EAP Method ..... EAP-TLS,EAP-TTLS/MSCHAPv2
  ANQP-element Configuration
    Info ID 1: Payload ..... 0000
    Info ID 20: Payload ..... 00000000
  GAS Address 3 Behavior ..... 0
  GAS Comeback Delay ..... 1000
  QoS Map Set configuration ...
  53,2,22,6,8,15,0,7,255,255,16,31,32,39,255,255,40,47,255,255
```

```
Hotspot2.0
  DGAF ..... Disable
  L2 Traf Inspect and Filter .. Disable
  ANQP Domain ID ..... 0
  Deauth Request Timeout ..... 60
  Operator Friendly Name
  ID 1:
    Language Code ..... jpn
    Friendly Name ..... TestJP
  ID 2:
    Language Code ..... eng
    Friendly Name ..... TestNZ
  Connection Capability
  IP Protocol 1:
    Port ..... 0
    Status ..... open
  IP Protocol 12:
    Port ..... 80
    Status ..... open
  WAN Metrics
  WAN Information ..... 01
  Speed Uplink/Downlink ..... 384/2500
  Load Uplink/Downlink ..... 0/0
  Load Measure Duration ..... 10
  Operating Class Indication .. 51
  OSU Status ..... Enable
  OSU SSID ..... osul
  OSU Providers
  OSU Server URI ..... https://example.com/osu/
  OSU Friendly Names
  Name 1:
    Language Code ... eng
    Name ..... TestUS
  Name 2:
    Language Code ... jpn
    Name ..... TestJP
  OSU NAI ..... anonymous@example.com
  OSU Method List ..... oma-dm soap-xml-spp
  OSU Service Descriptions
  Desc 1:
    Language Code ... eng
    Description ..... Example service1
  Desc 2:
    Language Code ... jpn
    Description ..... Example service2
  OSU Icons
  File 1:
    Language Code ... eng
    File Name ..... US_ICON.png
  File 2:
    Language Code ... jpn
    File Name ..... JP_ICON.png
```

Related commands [network \(wireless\)](#)
[description \(wireless-network\)](#)
[vlan \(wireless-network\)](#)

ssid (wireless-network)
band-steering (wireless-network)
external-page-url
walled-garden entry
radius accounting enable
emergency-service-reachable enable (wireless-network-passpoint-dot11u)
passpoint
security (wireless)
wireless-trigger-id
dup-auth-received (wireless-network)

Command changes Version 5.4.7-2.4: command added.

show wireless power-channel calculate

Overview Use this command to display the result of the optimal power per channel as calculated by Autonomous Wave Control (AWC).

Note: To see the currently assigned power per channel, use the command [show wireless ap power-channel](#).

Syntax `show wireless power-channel calculate`

Mode Privileged Exec

Example To display the optimal power for each channel as calculated by AWC, use the following command:

```
awplus# show wireless power-channel calculate
```

Output Figure 52-19: Example output from **show wireless power-channel calculate**

```
awplus#show wireless power-channel calculate

Latest Calculated Time: 2017-07-05 12:01:19
Latest Applied Time   : 2017-07-05 23:01:19AP
Radio1 ch Radio2 ch Radio1 PWR Radio2 PWR MAC address
-----
1      4      -      80      -      1234.abcd.5678
2      1      52      50      66      1234.abef.9876
10     13     36      44      70      abcd.5678.1234
20     6      44      100     83      42d9.2a00.1ff4
```

Related commands [type power-channel ap all](#)
[show wireless ap power-channel](#)

Command changes Version 5.4.7-2.4: command added.

show wireless sc-profile

Overview Use this command to display the Smart Connect profile configuration.

Syntax `show wireless sc-profile [<sc-profile-range>|all] [brief]`

Parameter	Description
<code><sc-profile-range></code>	The Smart Connect profile ID or IDs to display. Select from the range 1-65535
<code>all</code>	Display all Smart Connect profiles
<code>brief</code>	Display a brief summary of the Smart Connect profile configuration

Mode Privileged Exec

Example To display all the Smart Connect profile information, use the command:

```
awplus# show wireless sc-profile all
```

Output Figure 52-20: Example output from **show wireless sc-profile all**

```
awplus#show wireless sc-profile all
SC-PROFILE ID 1:
Description ..... SC PROFILE 01
SSID ..... SC-Profile-01-SSID
Key ..... a4kPHrm-3mA$a.9s
Auto Discovery ..... Disabl
Radio ..... 1
Channel ..... 1
DFS Channels ..... Exclude

SC-PROFILE ID 2:
Description ..... SC PROFILE 02
SSID ..... SC-Profile-02-SSID
Key ..... a4kPHrm-3mA$a.9s
Auto Discovery ..... Enable
Radio ..... 2
Channel ..... auto
DFS Channels ..... Exclude
```

Example To display a brief summary of the Smart Connect profile information, use the command:

```
awplus# show wireless sc-profile all brief
```

Output Figure 52-21: Example output from **show wireless sc-profile all brief**

```
awplus#show wireless sc-profile all brief
ID      SSID                               Auto Discovery R Ch  DFS
-----
  1 SC-Profile-01-SSID                Disable          1   1 Exc
  2 SC-Profile-02-SSID                Enable           2 auto Exc
```

- Related commands**
- [description \(wireless-sc-prof\)](#)
 - [ssid \(wireless-sc-prof\)](#)
 - [key \(wireless-sc-prof\)](#)
 - [auto-discovery disable](#)
 - [sc-channel](#)
 - [sc-profile](#)

Command changes Version 5.5.0-0.1: command added

show wireless security

Overview Use this command to display the Autonomous Wave Control (AWC) security configuration. If the **brief** parameter is specified, then a summary of the configuration is displayed, otherwise the detailed configuration is displayed.

Syntax `show wireless security [<security-id-range>|all] [brief]`

Parameter	Description
<security-id-range>	Display the security configuration for a specified ID range. Specify the ID range using the format <1-65535>
brief	Display the brief summary of the security configuration.
all	Display all wireless security configurations.

Mode Privileged Exec

Examples To display a detailed AWC security configuration, use the following command:

```
awplus# show wireless security
```

Output Figure 52-22: Example output from **show wireless security**

```
awplus# show wireless security
Security ID 1:
Security Mode ..... wpa-personal
Key ..... abcdefgh
Versions ..... wpa2
Ciphers ..... ccmp
Session Key Refresh Interval .. 100
Session Key Refresh Action ... Reauthentication
Bcast Key Refresh Interval .... 100
Management Frame Protection ... Enable(capable)
Dynamic-VLAN ..... Enable
Fast Roaming
Fast Transition ..... Disable
Over-the-DS ..... Disable
Mobility Domain ..... alb2
RMK-R0 Key Lifetime ..... 10000
Reassociation Deadline ..... 1000
AES Key .....
Radio Resource Management .... Disable
Wireless Network Management .. Disable
...
```

To display a brief (summary) AWC security configuration, use the following command:

```
awplus# show wireless security brief
```

```
awplus# show wireless security brief
ID      Mode      Status  Assigned Network  Assigned WDS
-----
1       wep       Enable  11,13,14,25,40..  65535
2       wpa-psnl Enable  22-24             2
3       wpa-ent  Disable -                 -
4       osen     Enable  -                 -
```

Related commands [security \(wireless-network\)](#)

Command changes Version 5.4.7-2.4: command added.

show wireless smart-connect ap

Overview Use this command to display AP connection status for Smart Connect.

Syntax show wireless smart-connect ap [*<sc-ap-range>*|all] status

Parameter	Description
<i><sc-ap-range></i>	Display the connection status for a single Smart Connect AP or range of APs. Select from ID range 1-65535.
all	Display the connection status for all Smart Connect APs.

Mode Privileged Exec

Output Figure 52-23: Example output from **show wireless smart-connect ap all status**

```
awplus#show wireless smart-connect ap all status
SC-PROFILE ID: 1
Last Update Time: 2019-12-12 11:14:35
Number of Smart Connect member: 1
AP      MAC Address          VAP Rx  VAP Tx  STA Rx  STA Tx (KB/sec)
-----
  1 *  0000.5e00.5301      1.3     2.2     0.0     0.0
  2 |- 0000.5e00.5302      0.0     0.0     0.5     0.7
  3 |- 0000.5e00.5303      0.0     0.0     0.5     0.6
```

Related commands [smart-connect-profile](#)
[sc-profile](#)

Command changes Version 5.5.0-0.1: command added

show wireless task

Overview Use this command to display the tasks associated with Autonomous Wave Control (AWC).

Syntax `show wireless task [<task-id-range>] [brief|status]`

Parameter	Description
<code><task-id-range></code>	Display the task information for a specific task ID or ID range.
<code>brief</code>	Display the task information in summary format.
<code>status</code>	Display the task status information. For example the date and time that the task will be performed next.

Mode User Exec and Privileged Exec

Usage notes An AWC task is a periodic or scheduled action to be taken, such as applying a configuration to an Access Point (AP) on a specified date, or calculating optimal AP power-channel usage and applying the results to all APs. See the **task** command for more details.

Example To display the configured AWC tasks in detail, use the command:

```
awplus# show wireless task
```

Output Figure 52-24: Example output from **show wireless task**

```
awplus# show wireless task
Task ID 1: Enable
Description ..... task1
Time ..... 10:00
Day ..... Sun,Wed,Sat
Type ..... Download
AP ..... 2-5
URL ..... http://allied-telesis.co.jp/hogehoge.img

Task ID 2: Enable
Description ..... task2
Time ..... 9:00
Day ..... Sun
Type ..... AP Configuration Apply
AP ..... 3,4Task ID 3: Enable
Description ..... task3
Time ..... 12:00
Day ..... every day
Type ..... Power Channel-Calculate
AP ..... AllTask ID 4: Enable
Description ..... task4
Time ..... 04:00
Day ..... Sat
Type ..... Power Channel-Apply
AP ..... All
```

Figure 52-25: Example output from **show wireless task brief**

```
awplus# show wireless task brief
ID   Description      Day   Time  Type           AP
----
1    task1            S--W--S 10:00 download       2-5
2    task2            S----- 09:00 ap conf apply  3,7
3    task3            SMTWTFS 12:00 pwrchnl-calc  All
4    task4            -----S 04:00 pwrchnl-apply All
```

Figure 52-26: Example output from **show wireless task status**

```
awplus# show wireless task status
Task ID 1: Enable
Description ..... task1
Applied AP ..... 2-5
Schedule
  Day ..... Sun,Wed,Sat
  Time ..... 10:00
Next Time ..... 2017-07-09 10:00:00
Last Time .....Task ID 2: Enable
Description ..... task2
Applied AP ..... 3,4
Schedule
  Day ..... Sun
  Time ..... 09:00
Next Time ..... 2017-07-09 09:00:00
Last Time .....Task ID 3: Enable
Description ..... task3
Applied AP ..... All
Schedule
  Day ..... every day
  Time ..... 12:00
Next Time ..... 2017-07-06 12:00:00
Last Time ..... 2017-07-05 12:01:19Task ID 4:
Enable
Description ..... task4
Applied AP ..... All
Schedule
  Day ..... Sat
  Time ..... 04:00
Next Time ..... 2017-07-08 04:00:00
Last Time .....
```

Related commands

- [wds](#)
- [enable \(wireless-task\)](#)
- [description \(wireless-task\)](#)
- [day \(wireless-task\)](#)
- [time \(wireless-task\)](#)
- [type download ap \(wireless-task\)](#)
- [type power-channel ap all](#)

Command changes

Version 5.4.7-2.4: command added.

show wireless wds

Overview Use this command to display the configuration of a Wireless Distribution System (WDS) with Autonomous Wave Control. A WDS enables the wireless interconnection of Access Points (APs) or Peers in an IEEE802.11 network.

Syntax `show wireless wds [<wds-id-range>][brief]`

Parameter	Description
<wds-id-range>	Display the configured information for a specified ID or a range of IDs. To display a range of WDS IDs, use the format <1-65535>.
brief	Display a brief summary of the WDS configuration.

Mode User Exec and Privileged Exec

Example To display the full detail of a WDS configuration for a wireless network, use the following command:

```
awplus# show wireless wds
```

Output Figure 52-27: Example output from **show wireless wds**

```
awplus#show wireless wds
WDS ID 1: Enable
  Peer 1st AP ..... 10
    2nd AP ..... 11
  Security ..... 100

WDS ID 2: Enable
  Peer AP1 ..... 20
    AP2 ..... abcd.1234.6789
  Security ..... 100

WDS ID 3: Disable
  Peer AP1 ..... 30
    AP2 ..... 16
  Security ..... 200
```

Figure 52-28: Example output from **show wireless wds brief**

```
awplus# show wireless wds brief
ID   Status  Peer 1st AP  Peer 2nd AP  Security
----  -----  -
1    Enable  10          11           100
2    Enable  20          abcd.1234.6789 100
3    Disable 30          16           200
```

Related commands wds
enable (wireless-wds)
peer (wireless-wds)
security (wireless-wds)

Command changes Version 5.4.7-2.4 command added.

show wireless wireless-mac-filter

Overview Use this command to display the wireless MAC filter configuration for Autonomous Wave Control.

Syntax `show wireless wireless-mac-filter [<mac-filter-range>|all]
[brief]`

Parameter	Description
<code><mac-filter-range></code>	<code><1-65535></code> Display the information for a specified ID or range of IDs.
<code>all</code>	Display the information for all MAC filters.
<code>brief</code>	Display a brief summary of the information

Mode Privileged Exec

Output Figure 52-29: Example output from **show wireless-mac-filter**

```
awplus#show wireless wireless-mac-filter

WIRELESS MAC FILTER ID 100:
  Description ..... Floor 1
  Entries ..... 3
  Entries ..... 2
    MAC address      Description
    -----
    1234.5678.abcd  PC lab 1
    0987.6543.abcd  guest
    abcd.9876.5432

WIRELESS MAC FILTER ID 200:
  Description .....
  Entries ..... 0
```

- Related commands**
- [description \(wireless-mac-flt\)](#)
 - [filter-entry](#)
 - [show wireless ap-profile](#)
 - [wireless export](#)
 - [wireless import](#)
 - [wireless-mac-filter \(wireless\)](#)
 - [wireless-mac-filter \(wireless-ap-prof\)](#)
 - [wireless-mac-filter enable](#)

Command changes Version 5.4.8-2.1: command added

show wireless wireless-trigger

Overview Use this command to display the wireless trigger status on a wireless network.

Syntax `show wireless wireless-trigger [all|<trigger-id>]`

Parameter	Description
<trigger-id>	Select an ID number between 1-8. You can also select a range of IDs using a comma separated list.

Default All

Mode Privileged Exec and User Exec

Example To display the status for all wireless triggers, use the commands:

```
awplus# show wireless wireless-trigger
```

Output Figure 52-30: Example output from **show wireless wireless-trigger**

```
awplus> show wireless wireless-trigger
Wireless Trigger ID 1:
  Description ..... Trigger 1
  Status ..... Inactive
Wireless Trigger ID 2:
  Description ..... Trigger 2
  Status ..... Active
  Activated User ..... Admin
  Activated Time ..... 2020-12-28 12:11:34
```

Related commands [wireless wireless-trigger](#)
[wireless-trigger](#)

[description \(wireless-trigger\)](#)

Command changes Version 5.5.1-0.1: command added

smart-connect-profile

Overview Use this command to create a Smart Connect profile and enter the Smart Connect profile configuration mode.

Use the **no** variant of this command to delete a Smart Connect profile from the wireless configuration.

Syntax smart-connect-profile <1-65535>
no smart-connect-profile <1-65535>

Parameter	Description
<1-65535>	The Smart Connect profile ID

Default Not set

Mode Wireless Configuration

Example To configure Smart Connect profile 10 and enter the Smart Connect profile configuration mode, use the commands:

```
awplus# configure terminal
awplus(config)# wireless
awplus(config-wireless)# smart-connect-profile 10
awplus(config-wireless-sc-prof)#
```

To delete Smart Connect profile 10, use the commands:

```
awplus# configure terminal
awplus(config)# wireless
awplus(config-wireless)# no smart-connect-profile 10
```

Related commands show wireless ap-profile
wireless
smart-connect-profile
auto-discovery disable
show wireless ap-profile
description (wireless-sc-prof)
ssid (wireless-sc-prof)
key (wireless-sc-prof)

Command changes Version 5.5.0-0.1: command added

snmp (wireless-ap-prof)

Overview Use this command to enter SNMP configuration mode so you can add an SNMP configuration.

Use the **no** variant of this command to reset the SNMP parameters back to the default (not set).

Syntax snmp
no snmp

Default Not set

Mode Wireless AP Profile Configuration

Example To enter the SNMP configuration mode of AP profile 2, use the commands:

```
awplus# configure terminal
awplus(config)# wireless
awplus(config-wireless)# ap-profile 2
awplus(config-wireless-ap-prof)# snmp
awplus(config-wireless-ap-prof-snmp)#
```

To disable SNMP, use the commands:

```
awplus# configure terminal
awplus(config)# wireless
awplus(config-wireless)# ap-profile 2
awplus(config-wireless-ap-prof)# no snmp
awplus(config-wireless-ap-prof)#
```

Related commands

- [community read-only \(wireless-ap-prof-snmp\)](#)
- [community trap \(wireless-ap-prof-snmp\)](#)
- [permit host \(wireless-ap-prof-snmp\)](#)
- [username \(wireless-ap-prof-snmp\)](#)
- [show wireless ap-profile](#)
- [version \(wireless-ap-prof-snmp\)](#)

Command changes Version 5.5.0-2.1: command added

ssid (wireless-network)

Overview Use this command to configure the SSID (Service Set Identifier) for the wireless network.

Syntax `ssid <value>`

Parameter	Description
<code><value></code>	The unique alphanumeric description or name of the SSID. The maximum character length is 32.

Default Default- {NETWORKID}.

Except for the default Guest Network, the default SSID for each network is 'Default-' followed by the unique Network ID.

Mode Wireless Network Configuration

Usage notes A network must be configured with an SSID of one or more alphanumeric characters. The SSID can be modified, but cannot be deleted.

Example To configure a SSID name for a wireless network, use the following commands:

```
awplus# configure terminal
awplus(config)# wireless
awplus(config-wireless)# network 20
awplus(config-wireless-network)# ssid GUEST_NETWORK_1
```

Related commands [network \(wireless\)](#)
[show wireless network](#)

Command changes Version 5.4.7-2.4: command added.

ssid (wireless-sc-prof)

Overview Use this command to set the SSID used for wireless communication between APs in a Smart Connect network.

Use the **no** variant of this command to remove the SSID from a Smart Connect profile.

Syntax `ssid <ssid-value>`
`no ssid`

Parameter	Description
<code><ssid-value></code>	The SSID for the Smart Connect network. Enter a string up to 32 characters in length.

Default Not set

Mode Wireless Smart Connect Profile Configuration

Example To set the SSID ID of 10 used for wireless communication between APs in Smart Connect network 20, use the commands:

```
awplus# configure terminal
awplus(config)# wireless
awplus(config-wireless)# smart-connect-profile 20
awplus(config-wireless-sc-prof)# ssid SC-NETWORK-10
```

Related commands [sc-profile](#)
[show wireless ap-profile](#)
[show wireless network](#)

Command changes Version 5.5.0-0.1: command added

station-isolation enable (wireless-ap-prof-radio)

Overview Use this command to enable the **station-isolation** option. This option designates whether to allow communication between wireless clients which are connected to the same Virtual Access Point (VAP).

Use the **no** variant of this command to disable the station-isolation option on a selected VAP.

Syntax station-isolation enable
no station-isolation enable

Default Disabled.

Mode Wireless AP Profile Radio Configuration

Example To enable the station-isolation option for **radio 2** on **ap-profile100**, use the following commands:

```
awplus# configure terminal
awplus(config)# wireless
awplus(config-wireless)# ap-profile 100
awplus(config-wireless-ap-prof)# radio 2
awplus(config-wireless-ap-prof-radio)# station-isolation
enable
```

Related commands [radio \(wireless-ap-profile\)](#)

Command changes Version 5.4.7-2.4: command added.

task

Overview Use this command to configure an Autonomous Wave Control (AWC) task. If the task doesn't exist, then this command creates it. Use the **no** variant of this command to remove the task.

Syntax task <1-65535>
no task <1-65535>

Parameter	Description
<1-65535>	Task ID number

Default Not set.

Mode Wireless Configuration

Usage notes A task is a configuration for a periodic or scheduled action to be taken. For example, the task may be to run a configuration, start an AWC calculation, or download AP firmware. Use commands such as **description**, **time**, and **day** to configure the task actions.

Example To add a task with an ID of 10, use the following commands:

```
awplus# configure terminal
awplus(config)# wireless
awplus(config-wireless)# task 10
```

To remove task ID 10, use the following commands:

```
awplus# configure terminal
awplus(config)# wireless
awplus(config-wireless)# no task 10
```

Related commands enable (wireless-task)
description (wireless-task)
time (wireless-task)
day (wireless-task)
type download ap (wireless-task)
type ap-configuration apply ap
type power-channel ap all

Command changes Version 5.4.7-2.4: command added

time (wireless-task)

Overview Use this command to set a time to run a task using the 24-hour format. You can use the **day** command along with the **time** command to more fully set the task run time configuration. Use the **no** variant of this command to remove the time set to run a task.

Syntax `time <HH:MM>`
`no time`

Parameter	Description
<HH:MM>	The time set to run a task in 24-hour time format.

Default Not set.

Mode Wireless Task Configuration

Example To set task 5 to run at 11:15 pm, use the following commands:

```
awplus# configure terminal
awplus(config)# wireless
awplus(config-wireless)# task 5
awplus(config-wireless-task)# time 23:15
```

Related commands [task](#)
[show wireless task](#)
[day \(wireless-task\)](#)

Command changes Version 5.4.7-2.4: command added.

trap host (wireless-ap-prof-snmp)

Overview Use this command to add an SNMP trap host to the entry for the target AP Profile. Use the **no** variant of this command to remove the specified SNMP trap host from the entry.

Syntax trap host <host-name>
no trap host <host-name>

Parameter	Description
<host-name>	The host that sends the SNMP trap. Specify the host name (FQDN) or IP address. For example manager.your.domain.com, 10.10.1.37.

Default The entry is empty.

Mode Wireless AP Profile SNMP Configuration

Usage notes The maximum number of registrations is 3 entries.

Example To add the SNMP trap host 192.168.1.1 to the entry, use the commands:

```
awplus# configure terminal
awplus(config)# wireless
awplus(config-wireless)# ap-profile 2
awplus(config-wireless-ap-prof)# snmp
awplus(config-wireless-ap-prof-snmp)# trap host 192.168.1.1
```

To remove the SNMP trap host 192.168.1.1 from the entry, use the commands:

```
awplus# configure terminal
awplus(config)# wireless
awplus(config-wireless)# ap-profile 2
awplus(config-wireless-ap-prof)# snmp
awplus(config-wireless-ap-prof-snmp)# no trap host 192.168.1.1
```

Related commands [enable \(wireless-ap-prof-snmp\)](#)
[show wireless ap-profile](#)
[snmp \(wireless-ap-prof\)](#)

Command changes Version 5.5.0-2.1: command added

type (wireless-sec-wep)

Overview Use this command to assign the key-string type for a wireless security WEP configuration.

Use the **no** variant of this command to reset the assigned WEP key-string type to the default.

Syntax type {ascii|hex}
no type

Parameter	Description
ascii	Use ASCII as the type for the WEP key
hex	Use Hex as the type for the WEP key

Default Hex.

Mode Wireless Security WEP Configuration

Example To configure ASCII as the key-string type for WEP for a wireless security WEP configuration, use the following commands:

```
awplus# configure terminal
awplus(config)# wireless
awplus(config-wireless)# network 10 mode wep
awplus(config-wireless-sec-wep)# type ascii
```

Related commands [security \(wireless\)](#)

Command changes Version 5.4.7-2.4: command added.

type ap-configuration apply ap

Overview Use this command to apply a task configuration type to a selected wireless Access Point (AP) or range of wireless APs.

Syntax `type ap-configuration apply ap {all|<ap-id-range>}`

Parameter	Description
all	Apply the configuration to all APs.
<ap-id-range>	Apply the configuration to a selected range of APs.

Default Not set.

Mode Wireless Task Configuration

Example To assign task 5 configuration to wireless AP ranges: 5-9 and 15-19, use the following commands:

```
awplus# configure terminal
awplus(config)# wireless
awplus(config-wireless)# task 5
awplus(config-wireless-task)# type ap-configuration apply ap
5-9,15-19
```

Related commands

- [task](#)
- [show wireless task](#)
- [ap](#)
- [type download ap \(wireless-task\)](#)

Command changes Version 5.4.7-2.4: command added.

type download ap (wireless-task)

Overview Use this command to download and update wireless Access Point (AP) firmware. The firmware must be stored on an HTTP server.

Syntax `type download ap {all|<ap-id-range>} url <URL> [username <user-name> password <password>]`

Parameter	Description
all	Run the task on all managed APs.
<ap-id-range>	Run the task on the selected identifier.
<URL>	The URL where the firmware is stored and can be downloaded from.
<user-name>	The username requiring authentication and access to the URL.
<password>	The password requiring authentication and access to the URL.

Mode Wireless Task Configuration

Example To set a task to download new firmware from the IP address 192.168.0.1 to a wireless AP which is assigned '7' as its identifier, use the following commands:

```
awplus# configure terminal
awplus(config)# wireless
awplus(config-wireless)# task 5
awplus(config-wireless-task)# type download ap 7 url
http://192.168.0.1/AT-TQ4600-4.0.3.b02.img
```

Related commands

- [task](#)
- [show wireless task](#)
- [ap](#)
- [type ap-configuration apply ap](#)
- [type power-channel ap all](#)

Command changes Version 5.4.7-2.4: command added.

type power-channel ap all

Overview Use this command to calculate the power usage on wireless Access Point (AP) channels and apply the results manually or automatically.

Syntax `type power-channel ap all {calculate|apply|calculate-and-apply}`

Parameter	Description
<code>calculate</code>	Run the AWC power calculation on all APs.
<code>apply</code>	Apply the latest AWC power calculation results to all APs.
<code>calculate-and-apply</code>	Run the AWC power calculation and apply the results to all APs.

Default Not set.

Mode Wireless Task Configuration

Usage notes This command allows you to monitor how APs are being utilized at various times and adjust AP power levels if required.

Example To calculate all AP power-channel usage and apply the results to all APs, use the following commands:

```
awplus# configure terminal
awplus(config)# wireless
awplus(config-wireless)# task 5
awplus(config)# type power-channel ap all calculate-and-apply
```

Related commands

- [task](#)
- [show wireless task](#)
- [type download ap \(wireless-task\)](#)
- [type ap-configuration apply ap](#)
- [show wireless power-channel calculate](#)

Command changes Version 5.4.7-2.4: command added.

unauth-emergency-service-access enable (wireless-network-passpoint-dot11u)

Overview Use this command to configure unauthenticated access to emergency services. This makes emergency services available to any user, with or without a valid authentication credential.

Use the **no** variant of this command to disable unauthenticated access to emergency services.

Syntax unauth-emergency-service-access enable
no unauth-emergency-service-access enable

Default Disabled.

Mode Wireless Network Passpoint 802.11u Configuration

Example To configure unauthenticated access to emergency services, use the commands:

```
awplus# configure terminal
awplus(config)# wireless
awplus(config-wireless)# network 1
awplus(config-wireless-network)# passpoint
awplus(config-wireless-network-passpoint)# dot11u
awplus(config-wireless-network-passpoint-dot11u)#
unauth-emergency-service-access enable
```

Related commands [show wireless network](#)
[dot11u \(wireless-network-passpoint\)](#)

Command changes Version 5.5.0-2.3: command added

username (wireless-ap-prof-snmp)

Overview Use this command to set an SNMP version v3 username and password for the target AP profile. This command is valid for SNMP version v3 only.

Use the **no** variant of this command to remove an SNMP username and password.

Syntax `username <username> password [encrypted] <password>`
`no username`

Parameter	Description
<username>	The user name that is used for user authentication and encryption. Enter up to 12 alphanumeric characters. The user name cannot begin with a number.
encrypted	Indicates that the following password is in its encrypted form. Its primary purpose is to use to store the shared key to startup-configuration. You should not use it when entering the command manually.
<password>	The password is used for encryption. Enter from 8 to 32 characters. Valid characters are: - alphanumeric characters - symbols except for the following 8 symbols: " \$ & ' * : < >

Default Not set

Mode Wireless AP Profile SNMP Configuration

Example To set the SNMP username to 'manager' and the password to 'friend001', use the commands:

```
awplus# configure terminal
awplus(config)# wireless
awplus(config-wireless)# ap-profile 2
awplus(config-wireless-ap-prof)# snmp
awplus(config-wireless-ap-prof-snmp)# username manager
awplus(config-wireless-ap-prof-snmp)# password friend001
```

To remove the SNMP username and password, use the commands:

```
awplus# configure terminal
awplus(config)# wireless
awplus(config-wireless)# ap-profile 2
awplus(config-wireless-ap-prof)# snmp
awplus(config-wireless-ap-prof)# no username
```

Related commands

- community read-only (wireless-ap-prof-snmp)
- community trap (wireless-ap-prof-snmp)
- permit host (wireless-ap-prof-snmp)
- show wireless ap-profile
- snmp (wireless-ap-prof)
- version (wireless-ap-prof-snmp)

Command changes

- Version 5.5.1-1.1: valid character set for password changed
- Version 5.5.0-2.1: command added

vap (wireless-ap-prof-radio)

Overview Use this command to assign a network configuration ID to a Virtual Access Point (VAP) on a radio.

Use the **no** variant of this command to remove the network configuration for a VAP.

Syntax vap <0-15> network <1-65535> [channel-blanket]
no vap <0-15>

Parameter	Description
<0-15>	VAP identification number
<1-65535>	Network configuration of the designated VAP
channel-blanket	Set the VAP to channel blanket mode

Default Not set

Mode Wireless AP Profile Radio Configuration

Usage notes The number of VAPs available depends on the access point model. See the AP's datasheet for details.

vap0 is the only VAP identification number valid on the **MWS series**.

Example To associate an AP with network (ID 100) to VAP 2, use the following commands:

```
awplus# configure terminal
awplus(config)# wireless
awplus(config-wireless)# ap-profile 100
awplus(config-wireless-ap-prof)# radio 2
awplus(config-wireless-ap-prof-radio)# vap 2 network 2
```

Related commands [radio \(wireless-ap-profile\)](#)
[network \(wireless\)](#)

Command changes Version 5.4.7-2.4: command added.

venue group (wireless-network-passpoint-dot11u)

Overview Use this command to designate the venue group used in a Passpoint 802.11u wireless configuration.

Use the **no** variant of this command to reset a venue group.

Syntax venue group <0-255>
no venue group

Parameter	Description
<0-255>	The venue group code. See IEEE 802.11-2016, Table 9-61 page 756.

Default 7

Mode Wireless Network Passpoint 802.11u Configuration

Example To set a venue group, use the commands:

```
awplus# configure terminal
awplus(config)# wireless
awplus(config-wireless)# network 1
awplus(config-wireless-network)# passpoint
awplus(config-wireless-network-passpoint)# dot11u
awplus(config-wireless-network-passpoint-dot11u)# venue group
2
```

Related commands [show wireless network](#)
[venue type \(wireless-network-passpoint-dot11u\)](#)

Command changes Version 5.5.1-1.1: command added.

venue name (wireless-network-passpoint-dot11u)

Overview Use this command to designate the venue name and language code used in a Passpoint 802.11u wireless configuration.

Use the **no** variant of this command to remove a venue name.

Syntax venue name <1-10> lang <lang-code> name <venue-name>
no venue name <1-10>

Parameter	Description
<1-10>	The venue name identifier number. If the specified identifier number does not exist, then a new one will be created. If it does exist, the language code and venue name will be overwritten.
<lang-code>	The language code. The code is 2 or 3 characters as specified in ISO-639. For example, 'eng', 'jpn'
<venue-name>	The venue name. <ul style="list-style-type: none">You can enter up to 10 separate entriesThe maximum number of characters is 252.

Default No name is set

Mode Wireless Network Passpoint 802.11u Configuration

Example To set a venue name, use the commands:

```
awplus# configure terminal
awplus(config)# wireless
awplus(config-wireless)# network 1
awplus(config-wireless-network)# passpoint
awplus(config-wireless-network-passpoint)# dot11u
awplus(config-wireless-network-passpoint-dot11u)# venue name 1
lang eng name Allied Telesis Ltd
```

Related commands [show wireless network](#)

Command changes Version 5.5.1-1.1: command added.

venue type (wireless-network-passpoint-dot11u)

Overview Use this command to designate the venue type used in a Passpoint 802.11u wireless configuration.

Use the **no** variant of this command to reset a venue type.

Syntax `venue type <0-255>`
`no venue type`

Parameter	Description
<code><0-255></code>	The venue type code. See IEEE 802.11-2016, Table 9-62 page 756-759.

Default 1

Mode Wireless Network Passpoint 802.11u Configuration

Example To set a venue type, use the commands:

```
awplus# configure terminal
awplus(config)# wireless
awplus(config-wireless)# network 1
awplus(config-wireless-network)# passpoint
awplus(config-wireless-network-passpoint)# dot11u
awplus(config-wireless-network-passpoint-dot11u)# venue type 2
```

Related commands [show wireless network](#)
[venue group \(wireless-network-passpoint-dot11u\)](#)

Command changes Version 5.5.1-1.1: command added.

version (wireless-ap-prof-snmp)

Overview Use this command to set the SNMP agent version for the target AP profile.
Use the **no** variant of this command to set it back to the default (v1 and v2c).

Syntax `version {v1v2c|v3}`
`no version`

Parameter	Description
v1v2c	Set when the SNMP agent version is at v1 or v2c.
v3	Set when the SNMP agent version is v3.

Default v1v2c

Mode Wireless AP Profile SNMP Configuration

Example To set the SNMP version as v3, use the commands:

```
awplus# configure terminal
awplus(config)# wireless
awplus(config-wireless)# ap-profile 2
awplus(config-wireless-ap-prof)# snmp
awplus(config-wireless-ap-prof-snmp)# version v3
```

To set the SNMP listening port back to the default (v1v2c), use the commands:

```
awplus# configure terminal
awplus(config)# wireless
awplus(config-wireless)# ap-profile 2
awplus(config-wireless-ap-prof)# snmp
awplus(config-wireless-ap-prof-snmp)# no version
```

Related commands

- [community read-only \(wireless-ap-prof-snmp\)](#)
- [community trap \(wireless-ap-prof-snmp\)](#)
- [permit host \(wireless-ap-prof-snmp\)](#)
- [show wireless ap-profile](#)
- [snmp \(wireless-ap-prof\)](#)
- [username \(wireless-ap-prof-snmp\)](#)

Command changes Version 5.5.0-2.1: command added

versions (wireless-sec-osen)

Overview Use this command to set which Wi-Fi Protected Access (WPA) version to use with OSEN wireless security configuration. OSEN is Online Sign Up (OSU) Server-only Authenticated Layer 2 Encryption Network. It is used with Release 2 of Hotspot 2.0 (Passpoint).

Use the **no** variant of this command to revert to the default setting (WPA2).

Syntax `versions <version-list>`
`no versions`

Parameter	Description
<code><version-list></code>	The supported WPA version(s) list. The list can use either wpa or wpa2 or wpa3 , or two of these three, or all in any order. OSEN only allows the following combinations: <ul style="list-style-type: none">• two combinations of wpa and wpa2• wpa only• wpa3 only

Default WPA2.

Mode Wireless Security OSEN Configuration

Usage notes OSEN is a wireless security method used with Release 2 of Hotspot 2.0 (Passpoint) OSEN is short for Online Sign Up (OSU) Server-only Authenticated Layer 2 Encryption Network. Use the **security** command to enter OSEN security configuration mode.

Example To set both WPA and WPA2 as WPA versions on a security configuration of OSEN, use the commands:

```
awplus# configure terminal
awplus(config)# wireless
awplus(config-wireless)# security 210 mode osen
awplus(config-wireless-sec-osen)# versions wpa wpa2
```

Related commands [show wireless security](#)
[security \(wireless\)](#)
[ciphers \(wireless-sec-osen\)](#)
[management-frame-protection enable \(wireless-sec-osen\)](#)

Command changes Version 5.5.0-2.3: command added

versions (wireless-sec-wpa-ent)

Overview Use this command to set the WPA version used for a WPA-enterprise wireless security configuration.

Use the **no** variant of this command to reset the designated version to the default.

Syntax `versions <version-list>`
`no versions`

Parameter	Description
<code><version-list></code>	The version list. You can use either wpa , wpa2 , wpa3 , or any combination of the three in any order.

Default `wpa2`.

Mode Wireless Security WPA-enterprise Configuration

Usage notes For MWS series devices, a combination of versions and ciphers are supported as follows:

- versions WPA2 and ciphers CCMP
- versions WPA, WPA2, and ciphers TKIP and CCMP

WPA3 is only supported on TS5403 series devices.

Example To configure both WPA and WPA2 as WPA versions on a security configuration for WPA-enterprise, use the following commands:

```
awplus# configure terminal
awplus(config)# wireless
awplus(config-wireless)# security 210 mode wpa-enterprise
awplus(config-wireless-sec-wpa-ent)# versions wpa wpa2
```

Related commands [security \(wireless\)](#)

Command changes Version 5.4.7-2.4: command added.
Version 5.4.9-1.1: **wpa3** parameter added.

versions (wireless-sec-wpa-psnl)

Overview Use this command to set the WPA version used for a WPA-personal wireless security configuration.
Use the **no** variant of this command to reset the designated version to the default.

Syntax `versions <version-list>`
`no versions`

Parameter	Description
<code><version-list></code>	The version list. You can use either wpa , wpa2 , wpa3 , or any combination of the three in any order.

Default `wpa2`.

Mode Wireless Security WPA-personal Configuration

Usage notes For MWS series devices, a combination of versions and ciphers are supported as follows:

- versions WPA2 and ciphers CCMP
- versions WPA, WPA2, and ciphers TKIP and CCMP

WPA3 is only supported on TS5403 series devices.

Example To configure both WPA and WPA2 as WPA versions on a security configuration for WPA-personal, use the following commands:

```
awplus# configure terminal
awplus(config)# wireless
awplus(config-wireless)# security 110 mode wpa-personal
awplus(config-wireless-sec-wpa-psnl)# versions wpa wpa2
```

Related commands [security \(wireless\)](#)

Command changes Version 5.4.7-2.4: command added.
Version 5.4.9-1.1: **wpa3** parameter added.

vlan (wireless-network)

Overview Use this command to configure the wireless VLAN that clients belong to.
Use the **no** variant of this command to reset the wireless VLAN to the default.

Syntax `vlan <1-4094>`
`no vlan`

Parameter	Description
<1-4094>	VLAN ID number.

Default VLAN1.

Mode Wireless Network Configuration

Example To configure a VLAN ID, use the following commands:

```
awplus# configure terminal
awplus(config)# wireless
awplus(config-wireless)# network 20
awplus(config-wireless-network)# vlan 100
```

To restore VLAN 20 to its default value, use the following commands:

```
awplus# configure terminal
awplus(config)# wireless
awplus(config-wireless)# network 20
awplus(config-wireless-network)# no vlan
```

Related commands [network \(wireless\)](#)
[show wireless network](#)

Command changes Version 5.4.7-2.4: command added

walled-garden entry

Overview Use this command to configure walled garden entry to a wireless network Captive Portal.

On the Internet, a walled garden typically controls a user's access to web content and services. The walled garden directs the user's navigation within particular areas to allow access to a selection of websites or prevent access to other websites.

A common example could be a hotel environment where unauthenticated users are allowed to navigate to a designated login page (for example, a hotel website) and all its contents.

Use the **no** variant of this command to remove a walled garden on a wireless network that's configured with a Captive Portal.

Syntax `walled-garden entry {A.B.C.D|A.B.A.D/M|FQDN}`
`no walled-garden entry {A.B.C.D|A.B.A.D/M|FQDN}`

Parameter	Description
A.B.C.D	IPv4 address format, e.g. 1.1.1.1
A.B.C.D/M	IPv4 address format with subnet mask, e.g. 1.1.1.0/24
FQDN	FDQN format. Sequence of {LETTER/DIGIT/HYPHEN}.{LETTER/DIGIT/HYPHEN}...while each dotted part of the name (aa or bb or cc in this example) MUST NOT end with HYPHEN and the first character MUST be a LETTER or a DIGIT. And each dotted part (aa or bb or cc in this example) must be 63 characters or less, e.g. example.com www.example.com

Default Not set

Mode Wireless Network Captive Portal Configuration

Example To add a new entry to a walled garden list on Captive Portal for network 20, use the commands:

```
awplus# configure terminal
awplus(config)# wireless
awplus(config-wireless)# network 20
awplus(config-wireless-network)# captive-portal
awplus(config-wireless-network-cp)# walled-garden entry
example.com
```

Related commands [captive-portal virtual-ip](#)
[show wireless network](#)

show wireless captive-portal network walled-garden

Command changes Version 5.5.0-1.3: command added

wan-metrics downlink-load (wireless-network-passpoint-hs20)

Overview Use this command to set the wan-metrics downlink-load for Hotspot 2.0.
Use the **no** variant of this command to revert to the default value.

Syntax wan-metrics downlink-load <0-255>
no wan-metrics downlink-load

Parameter	Description
<0-255>	WAN Metrics Down Link Load value Calculation formula: WAN line load factor (%) /100*255 For example: 75% -> 75/100*255=191

Default 80.

Mode Wireless Network Passpoint Hotspot 2.0 Configuration

Example To set a WAN Metrics Down Link Load of 191, use the commands:

```
awplus# configure terminal
awplus(config)# wireless
awplus(config-wireless)# network 1
awplus(config-wireless-network)# passpoint
awplus(config-wireless-network-passpoint)# hs20
awplus(config-wireless-network-passpoint-hs20)# wan-metrics
downlink-load 191
```

Related commands [show wireless network](#)
[hs20 \(wireless-network-passpoint\)](#)

Command changes Version 5.5.0-2.3: command added

wan-metrics downlink-speed (wireless-network-passpoint-hs20)

Overview Use this command to set the wan-metrics downlink-speed for Hotspot 2.0.
Use the **no** variant of this command to revert to the default value.

Syntax wan-metrics downlink-speed <1-4294967295>
no wan-metrics downlink-speed

Parameter	Description
<1-4294967295>	WAN Metrics Down Link Speed (kbps)

Default 8000.

Mode Wireless Network Passpoint Hotspot 2.0 Configuration

Example To set a WAN Metrics Down Link Speed of 191 kbps, use the commands:

```
awplus# configure terminal
awplus(config)# wireless
awplus(config-wireless)# network 1
awplus(config-wireless-network)# passpoint
awplus(config-wireless-network-passpoint)# hs20
awplus(config-wireless-network-passpoint-hs20)# wan-metrics
downlink-speed 191
```

Related commands [show wireless network](#)
[hs20 \(wireless-network-passpoint\)](#)

Command changes Version 5.5.0-2.3: command added

wan-metrics info (wireless-network-passpoint-hs20)

Overview Use this command to configure the WAN Metrics Link Status information for Hotspot 2.0.

Use the **no** variant of this command to revert to the default value.

Syntax wan-metrics info <HEX-value>
no wan-metrics info

Parameter	Description
<HEX-value>	A one or two digit hexadecimal number.
	Calculation formula: . <ul style="list-style-type: none">• (At Capacity << 3) (Symmetric Link << 2) (Link Status & 0x3) Bit placement: <ul style="list-style-type: none">• Bit[3]: At Capacity• Bit[2]: Symmetric Link• Bit[1:0]: Link Status At Capacity: Set to 1 to notify you that the line capacity on the WAN side has reached the upper limit. Symmetric Link: Set to 1 to notify you that Uplink/Downlink speed are the same value. Link Status: Configure as shown below: <ul style="list-style-type: none">• 1 (0b01) : Link up• 2 (0b10) : Link down• 3 (0b11) : Link in test state

Default 01

Mode Wireless Network Passpoint Hotspot 2.0 Configuration

Example To set the WAN Metrics Link Status information, use the commands:

```
awplus# configure terminal
awplus(config)# wireless
awplus(config-wireless)# network 1
awplus(config-wireless-network)# passpoint
awplus(config-wireless-network-passpoint)# hs20
awplus(config-wireless-network-passpoint-hs20)# wan-metrics
info 01
```

Related commands [show wireless network](#)

hs20 (wireless-network-passpoint)

Command changes Version 5.5.0-2.3: command added

wan-metrics load-measure-duration (wireless-network-passpoint-hs20)

Overview Use this command to set the wan-metrics load measure-duration for Hotspot 2.0. Use the **no** variant of this command to revert to the default value.

Syntax wan-metrics load-measure-duration <0-65535>
no wan-metrics load-measure-duration

Parameter	Description
<0-65535>	WAN Metrics Load Measure Duration value Calculation formula: Measurement interval (seconds)*10 For example: 2 second interval -> 2*10=20

Default 3000.

Mode Wireless Network Passpoint Hotspot 2.0 Configuration

Example To set a WAN Metrics Load Measure Duration value of 20, use the commands:

```
awplus# configure terminal
awplus(config)# wireless
awplus(config-wireless)# network 1
awplus(config-wireless-network)# passpoint
awplus(config-wireless-network-passpoint)# hs20
awplus(config-wireless-network-passpoint-hs20)# wan-metrics
load-measure-duration 20
```

Related commands [show wireless network](#)
[hs20 \(wireless-network-passpoint\)](#)

Command changes Version 5.5.0-2.3: command added

wan-metrics uplink-load (wireless-network-passpoint-hs20)

Overview Use this command to set the wan-metrics uplink-load for Hotspot 2.0.
Use the **no** variant of this command to revert to the default value.

Syntax wan-metrics uplink-load <0-255>
no wan-metrics uplink-load

Parameter	Description
<0-255>	WAN Metrics Up Link Load value Calculation formula: WAN line load factor (%) /100*255 For example: 75% -> 75/100*255=191

Default 240.

Mode Wireless Network Passpoint Hotspot 2.0 Configuration

Example To set a WAN Metrics Up Link Load of 191, use the commands:

```
awplus# configure terminal
awplus(config)# wireless
awplus(config-wireless)# network 1
awplus(config-wireless-network)# passpoint
awplus(config-wireless-network-passpoint)# hs20
awplus(config-wireless-network-passpoint-hs20)# wan-metrics
uplink-load 191
```

Related commands [show wireless network](#)
[hs20 \(wireless-network-passpoint\)](#)

Command changes Version 5.5.0-2.3: command added

wan-metrics uplink-speed (wireless-network-passpoint-hs20)

Overview Use this command to set the wan-metrics uplink-speed for Hotspot 2.0.
Use the **no** variant of this command to revert to the default value.

Syntax wan-metrics uplink-speed <1-4294967295>
no wan-metrics uplink-speed

Parameter	Description
<1-4294967295>	WAN Metrics Up Link Speed (kbps)

Default 1000.

Mode Wireless Network Passpoint Hotspot 2.0 Configuration

Example To set a WAN Metrics Up Link Speed of 10000 kbps, use the commands:

```
awplus# configure terminal
awplus(config)# wireless
awplus(config-wireless)# network 1
awplus(config-wireless-network)# passpoint
awplus(config-wireless-network-passpoint)# hs20
awplus(config-wireless-network-passpoint-hs20)# wan-metrics
uplink-speed 10000
```

Related commands [show wireless network](#)
[hs20 \(wireless-network-passpoint\)](#)

Command changes Version 5.5.0-2.3: command added

wds

Overview Use this command to add a Wireless Distribution System (WDS) configuration. Use the **no** variant of this command to remove a WDS configuration.

Syntax `wds <1-65535>`

Parameter	Description
<code><1-65535></code>	WDS configuration ID number.

Default Not set.

Mode Wireless Configuration

Usage notes This command adds a WDS configuration and enters the configuration mode.

Example To add a WDS configuration for AWC, use the following commands:

```
awplus# configure terminal
awplus(config)# wireless
awplus(config-wireless)# wds 10
```

To remove a WDS configuration for AWC, use the following commands:

```
awplus# configure terminal
awplus(config)# wireless
awplus(config-wireless)# no wds 10
```

Related commands

- [show wireless wds](#)
- [enable \(wireless-wds\)](#)
- [peer \(wireless-wds\)](#)
- [security \(wireless-wds\)](#)

Command changes Version 5.4.7-2.4: command added.

wds radio (wireless-ap)

Overview Use this command to designate a radio interface for an Access Point (AP) in a Wireless Distribution System (WDS) network.

Use the **no** variant of this command to remove a wireless radio interface.

Syntax `wds radio <1-3>`
`no wds radio`

Parameter	Description
<1-3>	Designate a radio interface for the WDS connection.

Default Not set.

Mode Wireless AP Configuration

Example To configure 'radio 2' as the radio interface for a WDS connection, use the following commands:

```
awplus# configure terminal
awplus(config)# wireless
awplus(config-wireless)# ap 100
awplus(config-wireless-ap)# wds radio 2
```

Related commands [ap](#)
[show wireless ap](#)

Command changes Version 5.4.7-2.4: command added.

web-auth radius auth group

Overview Use this command to enable Web authentication of clients with a RADIUS group in a wireless network.

Use the **no** variant of this command to disable Web authentication with a RADIUS group.

Syntax `web-auth radius auth group {radius|<group-name>}`
`no web-auth radius auth group`

Parameter	Description
<code>radius</code>	Use a RADIUS group, which means all RADIUS servers.
<code><group-name></code>	The RADIUS server group.

Default Not set.

Mode Wireless Network.

Usage notes This command enables Web authentication and designates a RADIUS server group to authenticate clients on a wireless network. RADIUS server groups are defined using the **aaa group server** command. RADIUS server groups can consist of multiple server hosts, but this command only uses two servers.

Example To enable Web authentication with a RADIUS server group, use the following commands:

```
awplus# configure terminal
awplus(config)# wireless
awplus(config-wireless)# network 10
awplus(config-wireless-network)# web-auth radius auth group
radius
```

Related commands [aaa group server](#)
[network \(wireless\)](#)

Command changes Version 5.4.7-2.4: command added.

wireless

Overview Use this command to enter wireless configuration mode.
Use the **no** variant of this command to exit wireless configuration mode.

Syntax wireless
no wireless

Mode Global Configuration

Example To enter wireless configuration mode, use the following commands:

```
awplus# configure terminal
awplus(config)# wireless
awplus(config-wireless)#
```

Command changes Version 5.4.7-2.4: command added.

wireless ap-configuration apply ap

Overview Use this command to apply a configuration to a single Access point (AP) or a range of APs. The configuration must exist before you use this command.

Syntax `wireless ap-configuration apply ap {all|<ap-idrange>}`

Parameter	Description
all	Apply the configuration to all APs.
<ap-idrange>	Apply the configuration to a range of APs. The range format is 1-65535.

Mode Privileged Exec

Example To apply a configuration to the AP range 1-10, use the command:

```
awplus# configure terminal  
awplus(config)# wireless ap-configuration apply 1-10
```

To apply a configuration to all APs, use the command:

```
awplus# wireless ap-configuration apply ap all
```

Related commands [ap](#)

Command changes Version 5.4.7-2.4: command added.

wireless auto-config

Overview Use this command to start an automatic discovery and configuration of wireless APs using Autonomous Wave Control (AWC).

Syntax

```
wireless auto-config create-new [country-code <code>]  
wireless auto-config ap-profile <1-65535>  
wireless auto-config abort
```

Parameter	Description
ap-profile	This parameter selects an existing profile to use for configuring the newly discovered APs.
<1-65535>	Profile ID number from the range 1 to 65535.
create-new	This parameter automatically creates a new profile based on the AP's model name.
country-code	Optional parameter, if specified the new profiles will have the country code set.
<code>	A two letter code representing the country. Use the command show wireless country-code to see the full list of country codes available.
abort	This parameter stops the automatic discovery process.

Mode Privileged Exec

Usage notes AP configuration is created for discovered APs including their IP addresses and MAC addresses. The AP profile is created automatically based on the model name. The network and security is created using defined default values.

Use the **abort** parameter to stop the automatic discovery process from continuing.

Examples To start an automatic discovery and configuration of a wireless network and apply the profile ID "1", use the command:

```
awplus# wireless auto-config ap-profile 1
```

To start an automatic discovery and configuration of a wireless network with a new AP profile, use the command:

```
awplus# wireless auto-config create-new
```

To stop an automatic discovery configuration, use the command:

```
awplus# wireless auto-config abort
```

Related commands [show wireless auto-config](#)

Command changes Version 5.4.8-1.1: command added

wireless download ap url

Overview Use this command to download Access Point (AP) firmware from a URL.

Syntax wireless download ap {all|<aprange>} url [username <user-name>
password <password>]

Parameter	Description
all	All APs.
<aprange>	A range of APs <1-65535>
username <user-name>	The login username. The username can contain: <ul style="list-style-type: none">• up to 255 characters.• any printable ASCII characters (ASCII 32-126)• special characters: backslash, double-quote or space, but they should be escaped with a backslash.
password <password>	Passwords can be up to 64 characters in length and can contain printable characters, except: <ul style="list-style-type: none">• ?• "(double quotes)• space

Default Not set.

Mode Privileged Exec

NOTE: AWC supports the following firmware version:

- TW series: v4.0.5B02
- MWS2533AP: v2.2.1, v2.2.3
- MWS600AP/MWS1750AP: v2.2.3

Example To download new firmware to all APs from the URL 192.168.0.1, use the following commands:

```
awplus# configure terminal
awplus(config)# wireless
awplus(config-wireless)# wireless download ap all url
http://192.168.0.1/AT-TQ4600-4.0.3.n.b02.img
```

Related commands [show wireless ap](#)

Command changes Version 5.4.7-2.4: command added.

wireless emergency-mode

Overview Use this command to activate or deactivate AWC emergency mode. Wireless networks that have been flagged for emergency-mode are activated or deactivated when this command is configured.

Syntax `wireless emergency-mode {activate|deactivate}`

Default Deactivated

Mode Privileged Exec

Example To activate the emergency mode in AWC, use the command:

```
awplus# wireless emergency-mode activate
```

Related commands [emergency-mode](#)
[show wireless](#)

Command changes Version 5.5.0-0.3: command added

wireless emergency-mode usb mark key

Overview Use this command to prepare a USB stick for putting your wireless network into Emergency Mode and add a key to that stick. If someone inserts that USB stick into the device, AlliedWare Plus will check whether the device also contains this key. If it does, then the device will put the network into emergency mode.

Along with this command, use [emergency-mode usb key](#) to add the same key to the device.

Syntax `wireless emergency-mode usb mark key <key>`
`wireless emergency-mode usb unmark`

Parameter	Description
<code>key <key></code>	The key, which can be up to 32 characters long. You can use any printable ASCII characters. If you use spaces or symbols, enclose the key in quote marks, for example "Example Key1".
<code>mark</code>	Prepare the USB stick for emergency mode use.
<code>unmark</code>	Remove the emergency mode configuration and key from the USB stick.

Default No USB sticks are configured.

Mode Privileged Exec

Example To configure this feature, first create a suitable wireless network and reserve it for emergency mode only. To reserve the network, use the command [emergency-mode](#).

Then insert an empty USB stick into the AlliedWare Plus device and use the following commands:

```
awplus# configure terminal
awplus(config)# wireless
awplus(config-wireless)# emergency-mode usb enable
awplus(config-wireless)# emergency-mode usb key ExampleKey
description ExampleEmergencyUSB
awplus(config-wireless)# end
awplus# wireless emergency-mode usb mark key ExampleKey
```

The **key** parameter in the commands [emergency-mode usb key](#) and [wireless emergency-mode usb mark key](#) must match.

After this, to put the network into emergency mode, just insert the USB stick. As long as the keys on the device and the stick match, emergency mode will automatically activate. The device's port LEDs will blink to indicate it is in emergency mode.

- Related commands**
- emergency-mode
 - emergency-mode usb enable
 - emergency-mode usb key
 - show wireless
- Command changes**
- Version 5.5.2-1.1: command added

wireless export

Overview Use this command to export MAC filter entries to a CSV file. If the specified file does not exist, it will be created. If the file does exist then it will be overwritten with the new data.

Syntax `wireless export wireless-mac-filter <mac-filter-id> <url>`

Parameter	Description
<code><mac-filter-id></code>	<code><1-65535></code> The ID of the MAC filter to export.
<code><url></code>	Path and filename of the export file.

Mode Privileged Exec

Example To export MAC filter '20' to a CSV file named 'whitelist.csv', use the following command:

```
awplus# wireless export wireless-mac-filter 20  
flash://whitelist.csv
```

Figure 52-31: Sample export file:

```
"00:1a:eb:12:34:56","client1"  
"00:1a:eb:12:34:57","client2"  
"00:1a:eb:12:34:58","client3"  
"00:1a:eb:12:34:59","client4"  
"00:1a:eb:12:34:5a","client5"
```

Related commands

- [description \(wireless-mac-flt\)](#)
- [filter-entry](#)
- [show wireless ap-profile](#)
- [show wireless wireless-mac-filter](#)
- [wireless import](#)
- [wireless-mac-filter \(wireless\)](#)
- [wireless-mac-filter \(wireless-ap-prof\)](#)
- [wireless-mac-filter enable](#)

Command changes Version 5.4.8-2.1: command added

wireless get-tech abort

Overview Use this command to stop getting technical support files from a single managed AP, or all of the APs that belong to an AWC-CB or AWC-SC profile.

Syntax `wireless get-tech abort`

Mode Privileged Exec

Usage notes This command aborts **all** technical-support files executed by the commands: **wireless get-tech ap**, **wireless get-tech ap-profile** and **wireless get-tech sc-profile**. You can not specify the behavior for a specific AP at the time of execution.

Example To abort all technical support files, use the command:

```
awplus# wireless get-tech abort
```

Output Figure 52-32: Example output from **show wireless ap 1 status** before and after issuing the command **wireless get-tech abort**. You can see the operation 'rupt' state changes from **'E'** (Executing) to **'F'** (Failed).

```
awplus#wireless get-tech ap 1 url flash://tech/
awplus#
awplus#show wireless ap 1 status
ID      Model          FW ver      Manage rupt Config  c Clnt  Uptime
-----
  1 AT-TQ5403      6.0.2-0.1  Managd ---E Succeed -    0  850051
awplus#
awplus#
awplus#
awplus#
awplus#wireless get-tech abort
awplus#
awplus#show wireless ap 1 status
ID      Model          FW ver      Manage rupt Config  c Clnt  Uptime
-----
  1 AT-TQ5403      6.0.2-0.1  Managd ---F Succeed -    0  850051
awplus#
```

Related commands

- [wireless get-tech ap](#)
- [wireless get-tech ap-profile](#)
- [wireless get-tech sc-profile](#)
- [show wireless ap](#)

Command changes Version 5.5.2-0.1: command added

wireless get-tech ap

Overview Use this command to get technical support files from managed wireless APs.

Syntax `wireless get-tech ap {<1-65535>|all} url <url>`

Parameter	Description
<1-65535>	The Access Point ID or range of IDs.
all	Get technical support files for all AP IDs.
<url>	The destination directory to store the technical support files. You can use flash, USB, or card prefixes. If no destination URL is set, then flash is used.

Mode Privileged Exec

Example To get the technical support files for all APs, and store those files to the 'tech' directory on flash, use the commands:

```
awplus# wireless get-tech ap all url flash:/tech/
```

Related commands

- [show wireless ap](#)
- [wireless get-tech sc-profile](#)
- [wireless get-tech ap-profile](#)
- [wireless get-tech abort](#)

Command changes Version 5.5.2-0.1: command added

wireless get-tech ap-profile

Overview Use this command to get technical support files from all managed wireless APs that use the specified AP Profile ID.

Syntax `wireless get-tech ap-profile {<1-65535>|all} url <url>`

Parameter	Description
<1-65535>	The AP Profile ID.
all	Get technical support files for managed APs for all Access Point Profile IDs.
<url>	The destination directory to store the technical support files. You can use flash, USB, or card prefixes. If no destination URL is set, then flash is used.

Mode Privileged Exec

Example To get the technical support files for APs in use for all Access Point Profile IDs, and store those files to the 'tech' directory on flash, use the commands:

```
awplus# wireless get-tech sc-profile all url flash:/tech/
```

Related commands

- [show wireless ap](#)
- [wireless get-tech ap](#)
- [wireless get-tech sc-profile](#)
- [wireless get-tech abort](#)

Command changes Version 5.5.2-0.1: command added

wireless get-tech sc-profile

Overview Use this command to get technical support files from all managed wireless APs that use the specified Smart Connect (SC) Profile ID.

Syntax `wireless get-tech sc-profile {<1-65535>|all} url <url>`

Parameter	Description
<1-65535>	The Smart Connect Profile ID.
all	Get technical support files for all Smart Connect Profile IDs.
<url>	The destination directory to store the technical support files. You can use flash, USB, or card prefixes. If no destination URL is set, then flash is used.

Mode Privileged Exec

Example To get the technical support files for APs in use for all Smart Connect Profiles, and store those files to the 'tech' directory on flash, use the commands:

```
awplus# wireless get-tech sc-profile all url flash:/tech/
```

Related commands

- [show wireless ap](#)
- [wireless get-tech ap](#)
- [wireless get-tech ap-profile](#)
- [wireless get-tech abort](#)

Command changes Version 5.5.2-0.1: command added

wireless import

Overview Use this command to import MAC filter entries from a CSV file. The imported entries can either replace or be appended to the existing entries.

Syntax `wireless import <url> wireless-mac-filter <mac-filter-id> {add|replace}`

Parameter	Description
<url>	Path and filename of the import file.
<mac-filter-id>	<1-65535> The ID of the MAC filter to import the entries to.
add	Add the filter entries to the specified MAC filter
replace	Overwrite the existing MAC filter with the imported entries.

Mode Privileged Exec

Example To add MAC filter entries from the file 'whitelist.csv' to MAC filter '20', use the following command:

```
awplus# wireless import flash://whitelist.csv  
wireless-mac-filter 20 add
```

Figure 52-33: Sample import file:

```
"00:1a:eb:12:34:56","client1"  
"00:1a:eb:12:34:57","client2"  
"00:1a:eb:12:34:58","client3"  
"00:1a:eb:12:34:59","client4"  
"00:1a:eb:12:34:5a","client5"
```

Related commands

- [description \(wireless-mac-flt\)](#)
- [filter-entry](#)
- [show wireless ap-profile](#)
- [show wireless wireless-mac-filter](#)
- [wireless export](#)
- [wireless-mac-filter \(wireless\)](#)
- [wireless-mac-filter \(wireless-ap-prof\)](#)
- [wireless-mac-filter enable](#)

Command changes Version 5.4.8-2.1: command added

wireless power-channel ap all

Overview This command activates AWC to calculate the optimal power-channel levels for all the Access Points (APs) in a wireless network. You can use this command to calculate and apply the latest AWC calculation results to the APs automatically or you can choose to apply them manually.

Syntax `wireless power-channel ap all
{calculate|apply|calculate-and-apply}`

Parameter	Description
<code>calculate</code>	Use AWC to calculate the optimal power-channel levels for all APs.
<code>apply</code>	Apply the latest AWC optimal power-channel level results to all APs.
<code>calculate-and-apply</code>	Use AWC to calculate the optimal power-channel levels for all APs, and apply the results to the APs.

Default Not set.

Mode Privileged Exec

Example To activate AWC to calculate the optimal power-channel levels for all APs, use the following commands:

```
awplus# configure terminal  
awplus(config)# wireless power-channel ap all calculate
```

To apply the latest optimal power-channel results manually to all APs, use the following commands:

```
awplus# configure terminal  
awplus(config)# wireless power-channel ap all apply
```

To activate AWC to calculate the optimal power-channel levels for all APs and then automatically apply the results to the APs, use the following commands:

```
awplus# configure terminal  
awplus(config)# wireless power-channel ap all  
calculate-and-apply
```

Related commands [show wireless ap power-channel](#)

Command changes Version 5.4.7-2.4: command added.

wireless reset ap

Overview Use this command to reset the current configuration applied to a wireless Access Point (AP).

Syntax `wireless reset ap {all|<aprange>}`

Parameter	Description
<aprange>	Reset the range of APs in the format <1-65535>
all	Reset all APs.

Mode Privileged Exec

Example To reset the configuration for wireless APs in the range 1-10, use the following commands:

```
awplus# configure terminal  
awplus(config)# wireless reset ap 1-10
```

To reset the configuration for all wireless APs, use the following commands:

```
awplus# configure terminal  
awplus(config)# wireless reset ap all
```

Related commands [ap](#)

Command changes Version 5.4.7-2.4: command added.

wireless-mac-filter (wireless)

Overview Use this command to configure a wireless MAC filter. If the filter does not already exist it will be created when you issue this command.

Use the **no** variant of this command to remove a wireless MAC filter.

Syntax `wireless-mac-filter <mac-filter-id>`
`no wireless-mac-filter <mac-filter-id>`

Parameter	Description
<code><mac-filter-id></code>	The ID of the MAC filter, in the range 1 to 65535.

Default No MAC filters are set by default.

Mode Wireless Configuration

Example To add a MAC filter with ID '20' and enter configuration mode for that filter, use the following commands:

```
awplus# configure terminal
awplus(config)# wireless
awplus(config-wireless)# wireless-mac-filter 20
awplus(config-wireless-mac-flt)#
```

To remove a MAC filter with ID '20', use the following commands:

```
awplus# configure terminal
awplus(config)# wireless
awplus(config-wireless)# no wireless-mac-filter 20
```

Related commands

- [description \(wireless-mac-flt\)](#)
- [filter-entry](#)
- [show wireless ap-profile](#)
- [show wireless wireless-mac-filter](#)
- [wireless export](#)
- [wireless import](#)
- [wireless-mac-filter \(wireless-ap-prof\)](#)
- [wireless-mac-filter enable](#)

Command changes Version 5.4.8-2.1: command added

wireless-mac-filter (wireless-ap-prof)

Overview Use this command to assign a MAC filter to a wireless AP profile. You can configure the filter as a 'whitelist' or a 'blacklist'. An AP profile can only have one MAC filter assigned to it.

Use the **no** variant of this command to remove a MAC filter from an AP profile.

Syntax wireless-mac-filter {permit|deny} <mac-filter-id>
no wireless-mac-filter

Parameter	Description
permit	Set the MAC filter as a whitelist.
deny	Set the MAC filter as a blacklist.
<mac-filter-id>	The ID of the MAC filter to assign to the AP profile, in the range 1 to 65535.

Default No MAC filter assigned by default.

Mode Wireless AP Profile Configuration

Example To assign the MAC filter '20' as a whitelist to wireless AP profile '1', use the following commands:

```
awplus# configure terminal
awplus(config)# wireless
awplus(config-wireless)# ap-profile 1
awplus(config-wireless-ap-prof)# wireless-mac-filter permit 20
```

To remove a MAC filter from wireless AP profile '1', use the following commands:

```
awplus# configure terminal
awplus(config)# wireless
awplus(config-wireless)# ap-profile 1
awplus(config-wireless-ap-prof)# no wireless-mac-filter
```

Related commands

- [description \(wireless-mac-flt\)](#)
- [filter-entry](#)
- [show wireless ap-profile](#)
- [show wireless wireless-mac-filter](#)
- [wireless export](#)
- [wireless import](#)
- [wireless-mac-filter \(wireless\)](#)

wireless-mac-filter enable

Command changes Version 5.4.8-2.1: command added

wireless-mac-filter enable

Overview Use this command to enable the MAC filter on a Virtual Access Point (VAP). It will enable the MAC filter based on the filter entry set in the AP profile.

Use the **no** variant of this command to disable the AMC filter on a VAP.

Syntax `wireless-mac-filter enable`
`no wireless-mac-filter enable`

Default Disabled by default.

Mode Wireless Network Configuration

Example To enable wireless MAC filter on APs that use network 100, use the following commands:

```
awplus# configure terminal
awplus(config)# wireless
awplus(config-wireless)# network 100
awplus(config-wireless-network)# wireless-mac-filter enable
```

To disable wireless MAC filter on APs that use network 100, use the following commands:

```
awplus# configure terminal
awplus(config)# wireless
awplus(config-wireless)# network 100
awplus(config-wireless-network)# no wireless-mac-filter enable
```

Related commands [description \(wireless-mac-flt\)](#)
[filter-entry](#)
[show wireless ap-profile](#)
[show wireless wireless-mac-filter](#)
[wireless export](#)
[wireless import](#)
[wireless-mac-filter \(wireless\)](#)
[wireless-mac-filter \(wireless-ap-prof\)](#)

Command changes Version 5.4.8-2.1: command added

wireless wireless-trigger

Overview Use this command to activate or deactivate a wireless-trigger. You can set an action for a specific trigger ID, range of IDs, or all wireless-trigger IDs.

Syntax `wireless wireless-trigger [all|<trigger-id>] activate`
`wireless wireless-trigger [all|<trigger-id>] deactivate`

Parameter	Description
all	Action all wireless-triggers.
<trigger-id>	The trigger ID. This can be a number in the range of 1-8. You can also specify multiple trigger IDs using a comma separated list.
activate	Activate wireless-trigger.
deactivate	Deactivate wireless-trigger.

Default Not set.

Mode Privileged Exec

Example To activate wireless-trigger 1, use the command:

```
awplus# wireless wireless-trigger 1 activate
```

To deactivate all wireless-triggers, use the command:

```
awplus# wireless wireless-trigger all deactivate
```

Related commands [show wireless wireless-trigger](#)
[wireless-trigger](#)
[description \(wireless-trigger\)](#)
[show wireless network](#)

Command changes Version 5.5.1-0.1: command added

wireless-trigger

Overview Use this command to add a wireless trigger and enter the wireless-trigger configuration mode.

Use the **no** variant of this command to delete a specific wireless-trigger ID configuration.

Syntax `wireless-trigger <trigger-id>`
`no wireless-trigger <trigger-id>`

Parameter	Description
<code><trigger-id></code>	Enter an ID number in the range 1-8.

Default Not set

Mode Wireless Configuration

Example To add a wireless trigger and enter the wireless-trigger configuration mode, use the commands:

```
awplus# configure terminal
awplus(config)# wireless
awplus(config-wireless)# wireless-trigger 1
awplus(config-wireless-trigger)#
```

To delete a wireless trigger, use the commands:

```
awplus# configure terminal
awplus(config)# wireless
awplus(config-wireless)# no wireless-trigger 1
```

Related commands

- [wireless wireless-trigger](#)
- [wireless-trigger-id](#)
- [description \(wireless-trigger\)](#)
- [show wireless network](#)
- [show wireless wireless-trigger](#)

Command changes Version 5.5.1-0.1: command added

wireless-trigger-id

Overview Use this command to mark a network for a wireless-trigger.
Use the **no** variant of this command to unmark a wireless trigger on a network.

Syntax `wireless-trigger-id <trigger-id>`
`no wireless-trigger-id <trigger-id>`

Parameter	Description
<code><trigger-id></code>	Trigger ID, a numerical value in the range 1-8. The trigger must already exist.

Default Not set.

Mode Wireless Network Configuration

Example To mark a wireless trigger in network 5, use the commands:

```
awplus# configure terminal
awplus(config)# wireless
awplus(config-wireless)# network 5
awplus(config-wireless-network)# wireless-trigger-id 1
```

Related commands [wireless wireless-trigger](#)
[wireless-trigger](#)
[description \(wireless-trigger\)](#)
[show wireless network](#)

Command changes Version 5.5.1-0.1: command added

53

Device Discovery using SNMP Commands

Introduction

Overview This chapter provides an alphabetical reference of commands used to configure Device Discovery using SNMP.

SNMP Device Discovery is available from the AlliedWare Plus CLI and is also available from Vista Manager mini. This feature provides information that allows the CLI to display third party vendor device data in real time.

For more information, see the [Device Discovery and Monitoring using SNMP Feature Overview and Configuration Guide](#).

- Command List**
- [“clear snmp-discovery”](#) on page 3045
 - [“service snmp-discovery”](#) on page 3046
 - [“show running-config snmp-discovery”](#) on page 3047
 - [“show snmp-discovery”](#) on page 3048
 - [“snmp-discovery arp-polling-interval”](#) on page 3051
 - [“snmp-discovery community”](#) on page 3052
 - [“snmp-discovery deny”](#) on page 3053
 - [“snmp-discovery permit”](#) on page 3055
 - [“snmp-discovery snmp-polling-interval”](#) on page 3056
 - [“snmp-discovery snmp-version”](#) on page 3057
 - [“snmp-discovery user”](#) on page 3058

clear snmp-discovery

Overview Use this command to remove information learned by the SNMP Discovery process.

Syntax `clear snmp-discovery ip [<ipv4-address>]`
`clear snmp-discovery nodes [<ipv4-address>]`

Parameter	Description
ip	Internet Protocol (IP)
<ipv4-address>	IPv4 network address for the discovered device, for example 192.168.3.1
nodes	Node information
<ipv4-address>	IPv4 network address for the discovered nodes, for example 192.168.3.1

Default No information is cleared.

Mode Privileged Exec

Examples To remove all SNMP discovered devices, use the command:

```
node1# clear snmp-discovery nodes
```

To remove a particular SNMP discovered device, use the command:

```
node1# clear snmp-discovery nodes 192.168.3.1
```

To remove all entries from SNMP Discovery's database of devices discovered by ARP, use the command:

```
node1# clear snmp-discovery ip
```

To remove a particular entry from SNMP Discovery's database of devices discovered by ARP, use the command:

```
node1# clear snmp-discovery ip 192.168.3.1
```

Related commands [show snmp-discovery](#)

Command changes Version 5.5.0-0.3: command added

service snmp-discovery

Overview Use this command to enable SNMP Discovery to discover devices on an AMF network.

Use the **no** variant of this command to disable SNMP Discovery.

Syntax `service snmp-discovery`
`no service snmp-discovery`

Default Disabled

Mode Global Configuration

Usage notes The server starts a process which detects IP addresses reachable on a network. An SNMP 'get' request is performed on these IP addresses to detect device information. The SNMP name, SNMP description, SNMP location, and SNMP serial number are obtained if they are available.

SNMP Discovery will not run if there are no Layer 3 IP interfaces configured.

Example To start the discovery service on the AMF node, use the commands:

```
awplus# configure terminal
awplus(config)# service snmp-discovery
```

Related commands [show snmp-discovery](#)
[snmp-discovery arp-polling-interval](#)
[snmp-discovery community](#)
[snmp-discovery deny](#)
[snmp-discovery permit](#)
[snmp-discovery snmp-polling-interval](#)
[snmp-discovery user](#)
[snmp-discovery snmp-version](#)

Command changes Version 5.5.0-0.3: command added

show running-config snmp-discovery

Overview Use this command to display the running configuration for SNMP Discovery.

Syntax `show running-config snmp-discovery`

Mode Privileged Exec

Example To display the running configuration for SNMP Discovery, use the command:

```
awplus# show running-config snmp-discovery
```

Output Figure 53-1: Example output from **show running-config snmp-discovery**

```
node1#show running-config snmp-discovery
service snmp-discovery
snmp-discovery community accounting
snmp-discovery user tim encrypted auth md5
U2FsdGVkX1/LyNttTLDzgJTG6Eh5g2L4ahgXuHLENA= priv des
U2FsdGVkX1+FJsefN+ZvSzUUviRt9ZdsFwtB6HU121U=
snmp-discovery permit ip 192.168.3.2
snmp-discovery permit ip 192.168.3.6
snmp-discovery deny ip 192.168.3.5
```

Related commands [show snmp-discovery](#)

Command changes Version 5.5.0-0.3: command added

show snmp-discovery

Overview Use this command to show information about the SNMP Discovery process.

Syntax `show snmp-discovery [detail|ip|nodes]`

Parameter	Description
detail	SNMP Discovery node detail
ip	SNMP Discovery IP addresses
nodes	SNMP Discovery node information

Mode User Exec

Examples To display information about the SNMP Discovery status, use the command:

```
awplus# show snmp-discovery
```

To display information about the SNMP Discovery IPv4 addresses learned, use the command:

```
awplus# show snmp-discovery ip
```

To display information about the SNMP Discovery nodes learned, use the command:

```
awplus# show snmp-discovery nodes
```

To display information about the SNMP Discovery in greater detail, use the command:

```
awplus# show snmp-discovery detail
```

Output Figure 53-2: Example output from **show snmp-discovery**

```
awplus#show snmp-discovery
SNMP Discovery information:
SNMP Discovery           : Enabled
SNMP Polling interval    : 300
ARP Polling interval     : 60
SNMP Discovery version   : v2c
SNMPv2 Discovery Community : accounting
```

Figure 53-3: Example output from **show snmp-discovery ip**

```
node1#show snmp-discovery ip
SNMP Discovery Devices:
```

IP Address	MAC Address	Type	State	Last Seen Time
172.18.100.10	-	Permit	-	-
172.18.100.25	0000.cd28.063e	Dynamic	Up	-
172.18.100.15	0001.30fe.c080	Dynamic	Up	-
172.18.100.208	801f.0230.006c	Dynamic	Down	Jul 27, 2020 03:52:01
172.18.100.209	801f.0230.006c	Dynamic	Down	Jul 24, 2020 04:45:30
172.18.100.20	0010.db5c.efe4	Dynamic	Up	-
172.18.100.207	801f.0230.006c	Dynamic	Down	Jul 27, 2020 06:26:20
172.18.100.10	001b.5443.a5b0	Dynamic	Up	-
172.18.100.205	801f.0230.006c	Dynamic	Down	Jul 27, 2020 17:15:15
172.18.100.204	801f.0230.006c	Dynamic	Down	Jul 25, 2020 19:20:35
172.18.100.203	801f.0230.006c	Dynamic	Down	Jul 25, 2020 21:15:04
172.18.100.202	801f.0230.006c	Dynamic	Unreachable	Jul 28, 2020 10:20:10

Figure 53-4: Example output from **show snmp-discovery nodes**

```
node1#show snmp-discovery nodes
SNMP Discovery Node information:
```

System Name	IP Address	MAC Address	Description
TQ1402	172.18.100.15	0001.30fe.c080	wireless access point ...
NAT-ROUTER-DESK	172.18.100.25	0000.cd28.063e	CentreCOM AR570S version ...

Number of SNMP discovered nodes: 2

Figure 53-5: Example output from **show snmp-discovery detail**

```
node1#show snmp-discovery detail
SNMP Discovery Node Details:

Name                TQ1402
Serial Number       FHK1115F13A
IP Address          172.18.100.10
MAC Address         001b.5443.a5b0
Local Interface     port1.0.1
Description         2-radio 802.11ac Wave 2 Wireless Access Point
State               Down
Location            -
Time Last Seen     2020-07-29T03:33:39Z

Name                NAT-ROUTER-DESK
Serial Number       -
IP Address          172.18.100.20
MAC Address         0010.db5c.efe4
Local Interface     port1.0.1
Description         Router building 2
State               Up
Location            -
Time Last Seen     -

Number of SNMP discovered nodes: 2
```

- Related commands**
- [clear snmp-discovery](#)
 - [service snmp-discovery](#)
 - [show running-config snmp-discovery](#)
 - [snmp-discovery arp-polling-interval](#)
 - [snmp-discovery deny](#)
 - [snmp-discovery permit](#)
 - [snmp-discovery snmp-polling-interval](#)

Command changes Version 5.5.0-0.3: command added

snmp-discovery arp-polling-interval

Overview Use this command to configure the SNMP ARP polling interval.

Use the **no** variant of this command to set the SNMP ARP polling interval back to the default (60 seconds).

Syntax `snmp-discovery arp-polling-interval <1-3600>`
`no snmp-discovery arp-polling-interval`

Parameter	Description
<code><1-3600></code>	The polling number in seconds to interval in the range from 1 to 3600.

Default ARP requests are sent out every 60 seconds

Mode Global Configuration

Usage notes SNMP Discovery first uses ARP to discover subnets that are reachable from the AMF node. This polling happens every 60 seconds by default. Use this command to change the polling interval.

Examples To configure the SNMP Discovery ARP polling interval to 120 seconds, use the commands:

```
awplus# configure terminal
awplus(config)# snmp-discovery arp-polling-interval 120
```

To set the SNMP Discovery ARP polling interval back to the default (60 seconds), use the commands:

```
awplus# configure terminal
awplus(config)# no snmp-discovery arp-polling-interval
```

Related commands [service snmp-discovery](#)
[show snmp-discovery](#)

Command changes Version 5.5.0-0.3: command added

snmp-discovery community

Overview Use this command to create an SNMP community in read-only mode for SNMPv1 and v2c only.

Use the **no** variant of this command to remove an SNMP community.

Syntax `snmp-discovery community <community-name>`

Parameter	Description
<code><community-name></code>	The name of the community that can be up to 20 characters long and is case sensitive.

Default The SNMP Discovery community name is 'public' by default

Mode Global Configuration

Usage notes This command creates an SNMP community in read-only mode. The community allows access to all MIB objects. The SNMP communities are only valid for SNMPv1 and v2c and provide very limited security. Communities should not be used for SNMPv3.

Examples To configure an SNMP community named 'accounting', use the commands:

```
awplus# configure terminal
awplus(config)# snmp-discovery community accounting
```

To set the SNMP community name back to the default (public), use the commands:

```
awplus# configure terminal
awplus(config)# no snmp-discovery community
```

Related commands [service snmp-discovery](#)
[show snmp-discovery](#)

Command changes Version 5.5.0-0.3: command added

snmp-discovery deny

Overview Use this command to prevent ARP requests from being sent. When an interface or IPv4 address is denied, it means an ARP request and SNMP 'get' request will never be sent to that device when the command **service snmp-discovery** is enabled.

Use the **no** variant of this command to remove the configuration.

Syntax

```
snmp-discovery deny interface <interface-range>  
snmp-discovery deny ip <ipv4-address>  
no snmp-discovery deny interface <interface-range>  
no snmp-discovery deny ip <ipv4-address>
```

Parameter	Description
interface	Interfaces to deny
<interface-name>	Interface name, for example VLAN2
ip	IP address
<ipv4-address>	IPv4 address to deny

Default The AMF management VLAN is denied

Mode Global Configuration

Examples To configure a deny interface command for VLAN2, use the commands:

```
awplus# configure terminal  
awplus(config)# snmp-discovery deny interface vlan2
```

To stop interface VLAN2 from being denied, use the commands:

```
awplus# configure terminal  
awplus(config)# no snmp-discovery deny interface vlan2
```

To configure a deny IP command for IP address 192.168.3.2, use the commands:

```
awplus# configure terminal  
awplus(config)# snmp-discovery deny ip 192.168.3.2
```

To stop IP address 192.168.3.2 from being denied, use the commands:

```
awplus# configure terminal  
awplus(config)# no snmp-discovery deny ip 192.168.3.2
```

Output Figure 53-6: Example output from **show snmp-discovery ip**

```
awplus#show snmp-discovery ip
SNMP Discovery Devices:
```

IP Address	MAC Address	Type	State	Last Seen Time
192.168.3.2	-	Deny	-	-
1.2.3.6	-	Permit	-	30 Jul, 2020 06:30:55
1.2.3.4	-	Permit	-	31 Jul, 2020 05:49:04
192.168.2.2	3863.bb5c.b900	Dynamic	Up	-

Related commands [service snmp-discovery](#)
[show snmp-discovery](#)

Command changes Version 5.5.0-0.3: command added

snmp-discovery permit

Overview Use this command if you want to allow SNMP Discovery to do requests on interfaces with greater than 256 members. You can permit a specific IP address.

Syntax `snmp-discovery permit ip <ipv4-address>`
`no snmp-discovery permit ip <ipv4-address>`

Parameter	Description
ip	Internet Protocol (IP)
<ipv4-address>	IPv4 network address

Default All IPv4 interfaces with 256 members or less are included in SNMP Discovery.

Mode Global Configuration

Examples To configure a permit IP command for the address 192.168.3.2, use the commands:

```
awplus# configure terminal  
awplus(config)# snmp-discovery permit ip 192.168.3.2
```

To remove the permit configuration for the address 192.168.3.2, use the commands:

```
awplus# configure terminal  
awplus(config)# no snmp-discovery permit ip 192.168.3.2
```

Output Figure 53-7: Example output from **show snmp-discovery ip**

```
awplus#show snmp-discovery ip  
SNMP Discovery Devices:
```

IP Address	MAC Address	Type	State	Last Seen Time
1.2.3.5	-	Deny	-	-
1.2.3.6	-	Permit	-	Jul 27, 2020 03:33:39
1.2.3.4	-	Permit	-	Jul 28, 2020 04:25:05
192.168.2.2	3863.bb5c.b900	Dynamic	Up	-
192.168.3.2	4263.cc3c.b500	permit	Up	-

Related commands [service snmp-discovery](#)
[show snmp-discovery](#)

Command changes Version 5.5.0-0.3: command added

snmp-discovery snmp-polling-interval

Overview Use this command to change the SNMP request polling interval (in seconds).
Use the **no** variant of this command to set the SNMP request polling interval back to the default (300 seconds).

Syntax `snmp-discovery snmp-polling-interval <60-3600>`
`no snmp-discovery snmp-polling-interval`

Parameter	Description
<60-3600>	The number of seconds for the SNMP polling interval. From the range 60 to 3600.

Default 300 seconds (5 minutes)

Mode Global Configuration

Usage notes ARP polling and SNMP Discovery uses SNMP 'get' requests to poll the devices discovered by the ARP polling. This polling happens every 300 seconds (5 minutes) by default.

SNMP polling is enabled when **service snmp-discovery** is enabled.

Examples To configure the SNMP discovery polling interval to 120 seconds, use the commands:

```
awplus# configure terminal
awplus(config)# snmp-discovery snmp-polling-interval 120
```

To set the SNMP discovery polling interval back to the default (300 seconds), use the commands:

```
awplus# configure terminal
awplus(config)# no snmp-discovery snmp-polling-interval
```

Related commands [service snmp-discovery](#)
[show snmp-discovery](#)

Command changes Version 5.5.0-0.3: command added

snmp-discovery snmp-version

Overview Use this command to set the SNMP version that you are using.
Use the **no** variant of this command to set the SNMP version back to the default (v2c).

Syntax `snmp-discovery snmp-version {v1|v2c|v3}`
`no snmp-discovery snmp-version`

Parameter	Description
v1	Enter the SNMP version number you are using
v2c	If you are using SNMP version v2c, set the community name with the command snmp-discovery community
v3	If you are using SNMP version v3, set the security with the command snmp-discovery user

Default SNMP version v2c

Mode Global Configuration

Usage notes This command defaults to SNMP version v2c and creates an SNMP community in read-only mode. The community allows access to all the MIB objects. The SNMP communities are only valid for SNMPv1 and v2c and provide very limited security. Communities should not be used when operating SNMPv3.

If using SNMPv3, you can choose the security level and then the authentication protocol and privacy protocol.

Examples To configure SNMP Discovery to use SNMP version 3, use the commands:

```
awplus# configure terminal  
awplus(config)# snmp-discovery snmp-version v3
```

To set the SNMP Discovery SNMP version back to the default (v2c), use the commands:

```
awplus# configure terminal  
awplus(config)# no snmp-discovery snmp-version
```

Related commands [service snmp-discovery](#)

Command changes Version 5.5.0-0.3: command added

snmp-discovery user

Overview Use this command to create a user for SNMPv3 'get' requests only.

Use the **no** variant of this command to remove an SNMPv3 user.

Syntax `snmp-discovery user <user-name> [encrypted] [auth {md5|sha} <auth-password>] [priv {des|aes} <privacy-password>]`
`no snmp-discovery user <user-name>`

Parameter	Description
<user-name>	The user name is a string up to 20 characters long and is case sensitive. For example, 'Rodger'.
encrypted	Use the encrypted parameter when you want to enter encrypted passwords.
auth	Authentication protocol that can be either MD5 or SHA.
md5	MD5 Message Digest Algorithms.
sha	SHA Secure Hash Algorithm.
<auth-password>	Authentication password that is a string from 8 to 20 characters and is case sensitive.
priv	Privacy protocol that can be either DES or AES.
des	DES Data Encryption Standard.
aes	AES Advanced Encryption Standards.
<privacy-password>	Privacy password is a string from 8 to 20 characters and is case sensitive.

Default No user is configured

Mode Global Configuration

Usage notes Additionally, this command provides the option of selecting an authentication protocol and (where appropriate) an associated password. Similarly, options are offered for selecting a privacy protocol and password.

The authentication method must match what is used on the devices being configured.

Use the **encrypted** parameter when you want to enter already encrypted passwords in encrypted form as displayed in the running and startup configurations stored on the switch.

User passwords are entered using plain text without the **encrypted** parameter and are encrypted according to the authentication and privacy protocols selected.

User passwords are viewed as encrypted passwords in running and startup configurations shown from the **show running-config** and **show startup-config**

commands. Copy and paste encrypted passwords from the running configuration or startup configuration to avoid entry errors.

Examples To add SNMP Discovery user 'authuser' with authentication protocol 'md5', authentication password 'authpass' privacy protocol 'des' and privacy password privpass, use the commands:

```
awplus# configure terminal
awplus(config)# snmp-discovery user authuser auth md5 Authpass
priv des Privpass
```

To enter existing SNMP user 'authuser' with existing passwords with authentication protocol 'md5' plus the encrypted authentication password '0x1c74b9c22118291b0ce0cd883f8dab6b74', privacy protocol 'des' plus the encrypted privacy password '0x0e0133db5453ebd03822b004eeacb6608f', use the following commands:

Note Copy and paste the encrypted passwords from the running-config or the startup-config displayed, using the show running-config and show startup-config commands respectively, into the command line to avoid key stroke errors issuing this command.

```
awplus# configure terminal
awplus(config)# snmp-discovery user authuser encrypted auth
md50x1c74b9c22118291b0ce0cd883f8dab6b74 priv des
0x0e0133db5453ebd03822b004eeacb6608f
```

To delete SNMP user 'authuser', use the following commands:

```
awplus# configure terminal
awplus(config)# no snmp-discovery user authuser
```

Output Figure 53-8: Example output from **show snmp-discovery**

```
awplus#show snmp-discovery
SNMP Discovery information:

SNMP Discovery                : Enabled
SNMP Polling interval         : 300
ARP Polling interval          : 60
SNMP Discovery version        : v3

SNMPv2 Discovery Community    : accounting
SNMPv3 Discovery User         : authuser
User Encrypted auth           : md5
User Encrypted password       : 0x1c74b9c22118291b0ce0cd883f8dab6b74
User Privilege                 : des
User Privilege password       : 0x0e0133db5453ebd03822b004eeacb6608f
```

Related commands [service snmp-discovery](#)
[show snmp-discovery](#)

Command changes Version 5.5.0-0.3: command added

54

Dynamic Host Configuration Protocol (DHCP) Commands

Introduction

Overview This chapter provides an alphabetical reference for commands used to configure DHCP.

Note that the DHCP client does not support tunnel interfaces.

For more information, see the [DHCP Feature Overview and Configuration Guide](#).

For information on filtering and saving command output, see the [“Getting Started with AlliedWare Plus” Feature Overview and Configuration Guide](#).

- Command List**
- [“bootfile”](#) on page 3062
 - [“clear ip dhcp binding”](#) on page 3063
 - [“default-router”](#) on page 3065
 - [“dns-server”](#) on page 3066
 - [“domain-name”](#) on page 3067
 - [“host \(DHCP\)”](#) on page 3068
 - [“ip address dhcp”](#) on page 3069
 - [“ip dhcp bootp ignore”](#) on page 3071
 - [“ip dhcp leasequery enable”](#) on page 3072
 - [“ip dhcp option”](#) on page 3073
 - [“ip dhcp pool”](#) on page 3075
 - [“ip dhcp-client default-route distance”](#) on page 3076
 - [“ip dhcp-client request vendor-identifying-specific”](#) on page 3078
 - [“ip dhcp-client vendor-identifying-class”](#) on page 3079
 - [“ip dhcp-relay agent-option”](#) on page 3080
 - [“ip dhcp-relay agent-option checking”](#) on page 3082

- [“ip dhcp-relay agent-option remote-id”](#) on page 3083
- [“ip dhcp-relay information policy”](#) on page 3084
- [“ip dhcp-relay maxhops”](#) on page 3086
- [“ip dhcp-relay max-message-length”](#) on page 3087
- [“ip dhcp-relay server-address”](#) on page 3089
- [“ip dhcp-relay use-client-side-address”](#) on page 3091
- [“lease”](#) on page 3092
- [“network \(DHCP\)”](#) on page 3094
- [“next-server”](#) on page 3095
- [“option”](#) on page 3096
- [“probe enable”](#) on page 3098
- [“probe packets”](#) on page 3099
- [“probe timeout”](#) on page 3100
- [“probe type”](#) on page 3101
- [“range”](#) on page 3102
- [“route”](#) on page 3103
- [“service dhcp-relay”](#) on page 3104
- [“service dhcp-server”](#) on page 3105
- [“short-lease-threshold”](#) on page 3106
- [“show counter dhcp-client”](#) on page 3108
- [“show counter dhcp-relay”](#) on page 3109
- [“show counter dhcp-server”](#) on page 3113
- [“show dhcp lease”](#) on page 3116
- [“show ip dhcp binding”](#) on page 3117
- [“show ip dhcp pool”](#) on page 3119
- [“show ip dhcp-relay”](#) on page 3124
- [“show ip dhcp server statistics”](#) on page 3126
- [“show ip dhcp server summary”](#) on page 3129
- [“subnet-mask”](#) on page 3130
- [“vrf”](#) on page 3131

bootfile

Overview This command sets the boot filename for a DHCP server pool. This is the name of the boot file that the client should use in its bootstrap process. It may need to include a path.

The **no** variant of this command removes the boot filename from a DHCP server pool.

Syntax bootfile <filename>
no bootfile

Parameter	Description
<filename>	The boot file name.

Mode DHCP Configuration

Example To configure the boot filename for a pool P2, use the command:

```
awplus# configure terminal
awplus(config)# ip dhcp pool P2
awplus(dhcp-config)# bootfile boot/main_boot.bt
```

clear ip dhcp binding

Overview This command clears either a specific lease binding or the lease bindings specified by the command or DHCP server. The command will only take effect on dynamically allocated bindings, not statically configured bindings.

Syntax `clear ip dhcp binding {ip <ip-address>|mac <mac-address>|all|pool <pool-name>|range <low-ip-address> <high-ip-address>}`

Syntax (VRF-lite) `clear ip dhcp binding [vrf <name>|global] {ip <ip-address>|mac <mac-address>|all|pool <pool-name>|range <low-ip-address> <high-ip-address>}`

Parameter	Description
vrf	Display the output for a VRF instance
<name>	The name of the specific VRF instance.
global	Display the output for the Global VRF instance
ip <ip-address>	IPv4 address of the DHCP client, in dotted decimal notation in the format A.B.C.D.
mac <mac-address>	MAC address of the DHCP client, in hexadecimal notation in the format HHHH.HHHH.HHHH.
all	All DHCP bindings.
pool <pool-name>	Description used to identify DHCP server address pool. Valid characters are any printable character. If the name contains spaces then you must enclose these in "quotation marks".
range <low-ip-address> <high-ip-address>	IPv4 address range for DHCP clients, in dotted decimal notation. The first IP address is the low end of the range, the second IP address is the high end of the range.

Mode User Exec and Privileged Exec

Usage A specific binding may be deleted by **ip** address or **mac** address, or several bindings may be deleted at once using **all**, **pool** or **range**.

Note that if you specify to clear the **ip** or **mac** address of what is actually a static DHCP binding, an error message is displayed. If **all**, **pool** or **range** are specified and one or more static DHCP bindings exist within those addresses, any dynamic entries within those addresses are cleared but any static entries are not cleared.

Examples To clear the specific IP address binding 192.168.1.1, use the command:

```
awplus# clear ip dhcp binding ip 192.168.1.1
```

To clear all dynamic DHCP entries, use the command:

```
awplus# clear ip dhcp binding all
```

Example (VRF-lite) To clear all dynamic binding from VRF red instance, use the command:

```
awplus# clear ip dhcp binding vrf red all
```

Related commands [show ip dhcp binding](#)

default-router

Overview This command adds a default router to the DHCP address pool you are configuring. You can use this command multiple times to create a list of default routers on the client's subnet. This sets the router details using the pre-defined option 3. Note that if you add a user-defined option 3 using the **option** command, then you will override any settings created with this command.

The **no** variant of this command removes either the specified default router, or all default routers from the DHCP pool.

Syntax `default-router <ip-address>`
`no default-router [<ip-address>]`

Parameter	Description
<code><ip-address></code>	IPv4 address of the default router, in dotted decimal notation.

Mode DHCP Configuration

Examples To add a router with an IP address 192.168.1.2 to the DHCP pool named P2, use the following commands:

```
awplus# configure terminal
awplus(config)# ip dhcp pool P2
awplus(dhcp-config)# default-router 192.168.1.2
```

To remove a router with an IP address 192.168.1.2 to the DHCP pool named P2, use the following commands:

```
awplus# configure terminal
awplus(config)# ip dhcp pool P2
awplus(dhcp-config)# no default-router 192.168.1.2
```

To remove all routers from the DHCP pool named P2, use the following commands:

```
awplus# configure terminal
awplus(config)# ip dhcp pool P2
awplus(dhcp-config)# no default-router
```

dns-server

Overview This command adds a Domain Name System (DNS) server to the DHCP address pool you are configuring. You can use this command multiple times to create a list of DNS name servers available to the client. This sets the DNS server details using the pre-defined option 6.

Note that if you add a user-defined option 6 using the [option](#) command, then you will override any settings created with this command.

The **no** variant of this command removes either the specified DNS server, or all DNS servers from the DHCP pool.

Syntax `dns-server <ip-address>`
`no dns-server [<ip-address>]`

Parameter	Description
<code><ip-address></code>	IPv4 address of the DNS server, in dotted decimal notation.

Mode DHCP Configuration

Examples To add the DNS server with the assigned IP address 192.168.1.1 to the DHCP pool named P1, use the following commands:

```
awplus# configure terminal
awplus(config)# ip dhcp pool P2
awplus(dhcp-config)# dns-server 192.168.1.1
```

To remove the DNS server with the assigned IP address 192.168.1.1 from the DHCP pool named P1, use the following commands:

```
awplus# configure terminal
awplus(config)# ip dhcp pool P2
awplus(dhcp-config)# no dns-server 192.168.1.1
```

To remove all DNS servers from the DHCP pool named P1, use the following commands:

```
awplus# configure terminal
awplus(config)# ip dhcp pool P2
awplus(dhcp-config)# no dns-server
```

Related commands

- [default-router](#)
- [option](#)
- [service dhcp-server](#)
- [show ip dhcp pool](#)
- [subnet-mask](#)

domain-name

Overview This command adds a domain name to the DHCP address pool you are configuring. Use this command to specify the domain name that a client should use when resolving host names using the Domain Name System. This sets the domain name details using the pre-defined option 15.

Note that if you add a user-defined option 15 using the [option](#) command, then you will override any settings created with this command.

The **no** variant of this command removes the domain name from the address pool.

Syntax `domain-name <domain-name>`
`no domain-name`

Parameter	Description
<code><domain-name></code>	The domain name you wish to assign the DHCP pool. Valid characters are any printable character. If the name contains spaces then you must enclose it in "quotation marks".

Mode DHCP Configuration

Examples To add the domain name `Nerv_Office` to DHCP pool P2, use the commands:

```
awplus# configure terminal
awplus(config)# ip dhcp pool P2
awplus(dhcp-config)# domain-name Nerv_Office
```

To remove the domain name `Nerv_Office` from DHCP pool P2, use the commands:

```
awplus# configure terminal
awplus(config)# ip dhcp pool P2
awplus(dhcp-config)# no domain-name Nerv_Office
```

Related commands

- [default-router](#)
- [dns-server](#)
- [option](#)
- [service dhcp-server](#)
- [show ip dhcp pool](#)
- [subnet-mask](#)

host (DHCP)

Overview This command adds a static host address to the DHCP address pool you are configuring. The client with the matching MAC address is permanently assigned this IP address. No other clients can request it.

The **no** variant of this command removes the specified host address from the DHCP pool. Use the **no host all** command to remove all static host addresses from the DHCP pool.

Syntax `host <ip-address> <mac-address>`
`no host <ip-address>`
`no host all`

Parameter	Description
<code><ip-address></code>	IPv4 address of the DHCP client, in dotted decimal notation in the format A.B.C.D
<code><mac-address></code>	MAC address of the DHCP client, in hexadecimal notation in the format HHHH.HHHH.HHHH

Mode DHCP Configuration

Usage Note that a network/mask must be configured using a **network** command before issuing a **host** command. Also note that a host address must match a network to add a static host address.

Examples To add the host at 192.168.1.5 with the MAC address 000a.451d.6e34 to DHCP pool 1, use the commands:

```
awplus# configure terminal
awplus(config)# ip dhcp pool 1
awplus(dhcp-config)# network 192.168.1.0/24
awplus(dhcp-config)# host 192.168.1.5 000a.451d.6e34
```

To remove the host at 192.168.1.5 with the MAC address 000a.451d.6e34 from DHCP pool 1, use the commands:

```
awplus# configure terminal
awplus(config)# ip dhcp pool 1
awplus(dhcp-config)# no host 192.168.1.5 000a.451d.6e34
```

**Related
Commands** [lease](#)
[range](#)

[show ip dhcp pool](#)

ip address dhcp

Overview This command activates the DHCP client on the interface you are configuring. This allows the interface to use the DHCP client to obtain its IP configuration details from a DHCP server on its connected network.

The **client-id** and **hostname** parameters are identifiers that you may want to set in order to interoperate with your existing DHCP infrastructure. If neither option is needed, then the DHCP server uses the MAC address field of the request to identify the host.

The DHCP client supports the following IP configuration options:

- Option 1— the subnet mask for your device.
- Option 3— a list of default routers.
- Option 6 — a list of DNS servers. This list appends the DNS servers set on your device with the [ip name-server](#) command.
- Option 15—a domain name used to resolve host names. This option replaces the domain name set with the [ip domain-name](#) command. Your device ignores this domain name if it has a domain list set using the [ip domain-list](#) command.
- Option 51—lease expiration time.

The **no** variant of this command stops the interface from obtaining IP configuration details from a DHCP server.

Syntax `ip address dhcp [client-id <interface>] [hostname <hostname>]`
`no ip address dhcp`

Parameter	Description
<code>client-id</code> <code><interface></code>	The name of the interface you are activating the DHCP client on. If you specify this, then the MAC address associated with the specified interface is sent to the DHCP server in the optional identifier field. Default: no default
<code>hostname</code> <code><hostname></code>	The hostname for the DHCP client on this interface. Typically this name is provided by the ISP. Default: no default

Mode Interface Configuration for VLAN, Eth, WWAN, and bridge interfaces and 802.1Q sub-interfaces.

Examples To set the interface `vlan2` to use DHCP to obtain an IP address, use the commands:

```
awplus# configure terminal
awplus(config)# interface vlan2
awplus(config-if)# ip address dhcp
```

To stop the interface vlan2 from using DHCP to obtain its IP address, use the commands:

```
awplus# configure terminal
awplus(config)# interface vlan2
awplus(config-if)# no ip address dhcp
```

Related commands

- [ip address \(IP Addressing and Protocol\)](#)
- [show ip interface](#)
- [show running-config](#)

ip dhcp bootp ignore

Overview This command configures the DHCP server to ignore any BOOTP requests it receives. The DHCP server accepts BOOTP requests by default.

The **no** variant of this command configures the DHCP server to accept BOOTP requests. This is the default setting.

Syntax `ip dhcp bootp ignore`
`no ip dhcp bootp ignore`

Mode Global Configuration

Examples To configure the DHCP server to ignore BOOTP requests, use the commands:

```
awplus# configure terminal
awplus(config)# ip dhcp bootp ignore
```

To configure the DHCP server to respond to BOOTP requests, use the commands:

```
awplus# configure terminal
awplus(config)# no ip dhcp bootp ignore
```

Related commands [show ip dhcp server summary](#)

ip dhcp leasequery enable

Overview Use this command to enable the DHCP server to respond to DHCPLEASEQUERY packets. Enabling the DHCP leasequery feature allows a DHCP Relay Agent to obtain IP address information directly from the DHCP server using DHCPLEASEQUERY messages.

Use the **no** variant of this command to disable the support of DHCPLEASEQUERY packets.

For more information, see the [DHCP Feature Overview and Configuration Guide](#).

Syntax ip dhcp leasequery enable
no ip dhcp leasequery enable

Default DHCP leasequery support is disabled by default.

Mode Global Configuration

Examples To enable DHCP leasequery support, use the commands:

```
awplus# configure terminal
awplus(config)# ip dhcp leasequery enable
```

To disable DHCP leasequery support, use the commands:

```
awplus# configure terminal
awplus(config)# no ip dhcp leasequery enable
```

Related commands [show counter dhcp-server](#)
[show ip dhcp server statistics](#)
[show ip dhcp server summary](#)

ip dhcp option

Overview This command creates a user-defined DHCP option. Options with the same number as one of the pre-defined options override the standard option definition. The pre-defined options use the option numbers 1, 3, 6, 15, and 51.

You can use this option when configuring a DHCP pool, by using the [option](#) command.

The **no** variant of this command removes either the specified user-defined option, or removes all user-defined options. This also automatically removes the user-defined options from the associated DHCP address pools.

Syntax `ip dhcp option <1-254> [name <option-name>] [<option-type>]`
`no ip dhcp option [<1-254>|<option-name>]`

Parameter	Description										
<1-254>	The option number of the option. Options with the same number as one of the standard options overrides the standard option definition.										
<option-name>	Option name used to identify the option. You cannot use a number as the option name. Valid characters are any printable character. If the name contains spaces then you must enclose it in "quotation marks". Default: no default										
<option-type>	The option value. You must specify a value that is appropriate to the option type: <table border="1"><tbody><tr><td>ascii</td><td>An ASCII text string</td></tr><tr><td>hex</td><td>A hexadecimal string. Valid characters are the numbers 0–9 and letters a–f. Embedded spaces are not valid. The string must be an even number of characters, from 2 and 256 characters long.</td></tr><tr><td>ip</td><td>An IPv4 address or mask that has the dotted decimal A.B.C.D notation. To create a list of IP addresses, you must add each IP address individually by using the option command multiple times.</td></tr><tr><td>integer</td><td>A number from 0 to 4294967295.</td></tr><tr><td>flag</td><td>A value that either sets (to 1) or unsets (to 0) a flag: true, on, or enabled will set the flag. false, off or disabled will unset the flag.</td></tr></tbody></table>	ascii	An ASCII text string	hex	A hexadecimal string. Valid characters are the numbers 0–9 and letters a–f. Embedded spaces are not valid. The string must be an even number of characters, from 2 and 256 characters long.	ip	An IPv4 address or mask that has the dotted decimal A.B.C.D notation. To create a list of IP addresses, you must add each IP address individually by using the option command multiple times.	integer	A number from 0 to 4294967295.	flag	A value that either sets (to 1) or unsets (to 0) a flag: true , on , or enabled will set the flag. false , off or disabled will unset the flag.
ascii	An ASCII text string										
hex	A hexadecimal string. Valid characters are the numbers 0–9 and letters a–f. Embedded spaces are not valid. The string must be an even number of characters, from 2 and 256 characters long.										
ip	An IPv4 address or mask that has the dotted decimal A.B.C.D notation. To create a list of IP addresses, you must add each IP address individually by using the option command multiple times.										
integer	A number from 0 to 4294967295.										
flag	A value that either sets (to 1) or unsets (to 0) a flag: true , on , or enabled will set the flag. false , off or disabled will unset the flag.										

Mode Global Configuration

Examples To define a user-defined ASCII string option as option 66, without a name, use the command:

```
awplus# configure terminal
awplus(config)# ip dhcp option 66 ascii
```

To define a user-defined hexadecimal string option as option 46, with the name `tcpip-node-type`, use the commands:

```
awplus# configure terminal
awplus(config)# ip dhcp option 46 name tcpip-node-type hex
```

To define a user-defined IP address option as option 175, with the name `special-address`, use the commands:

```
awplus# configure terminal
awplus(config)# ip dhcp option 175 name special-address ip
```

To remove the specific user-defined option with the option number 12, use the commands:

```
awplus# configure terminal
awplus(config)# no ip dhcp option 12
```

To remove the specific user-defined option with the option name `perform-router-discovery`, use the commands:

```
awplus# configure terminal
awplus(config)# no ip dhcp option perform-router-discovery
```

To remove all user-defined option definitions, use the commands:

```
awplus# configure terminal
awplus(config)# no ip dhcp option
```

**Related
commands**

[default-router](#)
[dns-server](#)
[domain-name](#)
[option](#)
[service dhcp-server](#)
[show ip dhcp server summary](#)
[subnet-mask](#)

ip dhcp pool

Overview This command will enter the configuration mode for the pool name specified. If the name specified is not associated with an existing pool, the device will create a new pool with this name, then enter the configuration mode for the new pool.

Once you have entered the DHCP configuration mode, all commands executed before the next **exit** command will apply to this pool.

You can create multiple DHCP pools on devices with multiple interfaces. This allows the device to act as a DHCP server on multiple interfaces to distribute different information to clients on the different networks.

The **no** variant of this command deletes the specific DHCP pool.

Syntax `ip dhcp pool <pool-name>`
`no ip dhcp pool <pool-name>`

Parameter	Description
<code><pool-name></code>	Description used to identify this DHCP pool. Valid characters are any printable character. If the name contains spaces then you must enclose it in "quotation marks".

Mode Global Configuration

Example To create the DHCP pool named P2 and enter DHCP Configuration mode, use the commands:

```
awplus# configure terminal
awplus(config)# ip dhcp pool P2
awplus(dhcp-config)#
```

To delete the DHCP pool named P2, use the commands:

```
awplus# configure terminal
awplus(config)# no ip dhcp pool P2
```

Related commands [service dhcp-server](#)

ip dhcp-client default-route distance

Overview Use this command to specify an alternative Administrative Distance (AD) for the current default route (from DHCP) for an interface.

Use the **no** variant of this command to set the AD back to the default of 1.

Syntax `ip dhcp-client default-route distance [<1-255>]`
`no ip dhcp-client default-route distance`

Parameter	Description
<1-255>	Administrative Distance (AD) from the range 1 though 255.

Default 1

Mode Interface Configuration for VLAN, Eth, WWAN, and bridge interfaces and 802.1Q sub-interfaces.

Usage notes DHCP client interfaces can automatically add a default route with an AD of 1 into the IP Routing Information Base (RIB).

Any pre-existing default route(s) via alternative interfaces (configured with a higher AD) will no longer be selected as the preferred forwarding path for traffic when the DHCP based default route is added to the IP routing table.

This can be problematic if the DHCP client is operating via an interface that is only intended to be used for back-up interface redundancy purposes, such as a VLAN containing a single switchport, or a 4G cellular interface on an AR-Series Firewall.

Use this command to set the AD of the default route (via a specific DHCP client interface) to a non-default (higher cost) value, ensuring any pre-existing default route(s) via any other interface(s) continue to be selected as the preferred forwarding path for network traffic.

When the command is used, the static default route is deleted from the RIB, the distance value of the route is modified to the configured distance value, then it is reinstalled into the RIB.

Examples To set the AD for the default route added by DHCP via cellular interface wwan0 to 150, use the commands:

```
awplus# configure terminal
awplus(config)# interface wwan0
awplus(config-if)# ip dhcp-client default-route distance 150
```

To set the AD for the default route back to the default value of 1, use the commands:

```
awplus# configure terminal
awplus(config)# interface wwan0
awplus(config-if)# no ip dhcp-client default-route distance
```

**Related
commands**

[show ip route](#)
[show ip route database](#)

**Command
changes**

Version 5.4.7-0.2 Command added.

ip dhcp-client request vendor-identifying-specific

Overview Use this command to add vendor-identifying vendor-specific information (option 125) requests to the DHCP discovery packets sent by an interface. This option, along with option 124, can be used to send vendor-specific information back to a DHCP client.

See RFC3925 for more information on Vendor-Identifying Vendor Options for DHCPv4.

Use the **no** variant of this command to remove the vendor-identifying-specific request from an interface.

Syntax `ip dhcp-client request vendor-identifying-specific`
`no ip dhcp-client request vendor-identifying-specific`

Default The vendor-identifying-specific request is not configured by default.

Mode Interface Configuration for VLAN, Eth, WWAN, and bridge interfaces and 802.1Q sub-interfaces.

Usage notes The DHCP client must be activated on the interface, using the [ip address dhcp](#) command, so that DHCP discovery packets are sent.

Example To add the vendor-identifying-specific request on vlan2, use the commands:

```
awplus# configure terminal
awplus(config)# interface vlan2
awplus(config-if)# ip dhcp-client request
vendor-identifying-specific
```

To remove the vendor-identifying-specific request on vlan2, use the commands:

```
awplus# configure terminal
awplus(config)# interface vlan2
awplus(config-if)# no ip dhcp-client request
vendor-identifying-specific
```

Related commands [ip address dhcp](#)
[ip dhcp-client vendor-identifying-class](#)

Command changes Version 5.4.7-2.1: command added

ip dhcp-client vendor-identifying-class

Overview Use this command to add a vendor-identifying vendor class (option 124) to the DHCP discovery packets sent by an interface. This option places the Allied Telesis Enterprise number (207) into the discovery packet. Option 124, along with option 125, can be used to send vendor-specific information back to a DHCP client.

See RFC3925 for more information on Vendor-Identifying Vendor Options for DHCPv4.

Use the **no** variant of this command to remove the vendor-identifying-class from an interface.

Syntax `ip dhcp-client vendor-identifying-class`
`no ip dhcp-client vendor-identifying-class`

Default The vendor-identifying-class is not configured by default.

Mode Interface Configuration for VLAN, Eth, WWAN, and bridge interfaces and 802.1Q sub-interfaces.

Usage notes The DHCP client must be activated on the interface, using the [ip address dhcp](#) command, so that DHCP discovery packets are sent.

Example To remove the vendor-identifying-class on vlan2, use the commands:

```
awplus# configure terminal
awplus(config)# interface vlan2
awplus(config-if)# no ip dhcp-client vendor-identifying-class
```

Related commands [ip address dhcp](#)
[ip dhcp-client request vendor-identifying-specific](#)

Command changes Version 5.4.7-2.1: command added

ip dhcp-relay agent-option

Overview This command enables the DHCP Relay Agent to insert the DHCP Relay Agent Information Option (Option 82) into the client-request packets that it relays to its DHCP server. This allows the DHCP Relay Agent to pass on information to the server about the network location of the client device. The DHCP Relay Agent strips the DHCP Relay Agent Option 82 field out of the DHCP server's response, so that the DHCP client never sees this field.

When the DHCP Relay Agent appends its DHCP Relay Agent Option 82 data into the packet, it first overwrites any pad options present; then if necessary, it increases the packet length to accommodate the DHCP Relay Agent Option 82 data.

The **no** variant of this command stops the DHCP Relay Agent from appending the Option 82 field onto DHCP requests before forwarding it to the server.

For DHCP Relay Agent and DHCP Relay Agent Option 82 introductory information, see the [DHCP Feature Overview and Configuration Guide](#).

NOTE: *The DHCP-relay service might alter the content of the DHCP Relay Agent Option 82 field, if the commands `ip dhcp-relay agent-option` and `ip dhcp-relay information policy` have been configured.*

Syntax

```
ip dhcp-relay agent-option  
no ip dhcp-relay agent-option
```

Default DHCP Relay Agent Information Option (Option 82) insertion is disabled by default.

Mode Interface Configuration for VLAN, Eth, WWAN, and bridge interfaces and 802.1Q sub-interfaces.

Usage notes Use this command to alter the DHCP Relay Agent Option 82 setting when your device is the first hop for the DHCP client. To limit the maximum length of the packet, use the [ip dhcp-relay max-message-length](#) command.

Examples To make the relay agent listening on eth1 append the DHCP Relay Agent Option 82 field, use the commands:

```
awplus# configure terminal  
awplus(config)# interface eth1  
awplus(config-if)# ip dhcp-relay agent-option
```

To stop the relay agent from appending the DHCP Relay Agent Option 82 field on eth1, use the commands:

```
awplus# configure terminal  
awplus(config)# interface eth1  
awplus(config-if)# no ip dhcp-relay agent-option
```

Related commands

- [ip dhcp-relay agent-option remote-id](#)
- [ip dhcp-relay information policy](#)
- [ip dhcp-relay max-message-length](#)
- [service dhcp-relay](#)

ip dhcp-relay agent-option checking

Overview This command enables the DHCP Relay Agent to check DHCP Relay Agent Information Option (Option 82) information in response packets returned from DHCP servers. If the information does not match the information it has for its own client (downstream) interface then the DHCP Relay Agent drops the packet. Note that [ip dhcp-relay agent-option](#) must be configured.

The DHCP Relay Agent Option 82 field is included in relayed client DHCP packets if:

- DHCP Relay Agent Option 82 is enabled ([ip dhcp-relay agent-option](#)), and
- DHCP Relay Agent is enabled on the device ([service dhcp-relay](#))

For DHCP Relay Agent and DHCP Relay Agent Option 82 introductory information, see the [DHCP Feature Overview and Configuration Guide](#).

Syntax `ip dhcp-relay agent-option checking`
`no ip dhcp-relay agent-option checking`

Mode Interface Configuration for VLAN, Eth, WWAN, and bridge interfaces and 802.1Q sub-interfaces.

Examples To make the relay agent listening on eth1 check the DHCP Relay Agent Information Option (Option 82) field, use the commands:

```
awplus# configure terminal
awplus(config)# interface eth1
awplus(config-if)# ip dhcp-relay agent-option
awplus(config-if)# ip dhcp-relay agent-option checking
```

To stop the relay agent from checking the DHCP Relay Agent Information Option (Option 82) field on eth1, use the commands:

```
awplus# configure terminal
awplus(config)# interface eth1
awplus(config-if)# no ip dhcp-relay agent-option checking
```

Related commands [ip dhcp-relay agent-option](#)
[ip dhcp-relay agent-option remote-id](#)
[ip dhcp-relay information policy](#)
[service dhcp-relay](#)

ip dhcp-relay agent-option remote-id

Overview Use this command to specify the Remote ID sub-option of the DHCP Relay Agent Option 82 field the DHCP Relay Agent inserts into clients' request packets. The Remote ID identifies the device that is inserting the DHCP Relay Agent Option 82 information. If a Remote ID is not specified, the Remote ID sub-option is set to the device's MAC address.

Use the **no** variant of this command to return the Remote ID for an interface.

For DHCP Relay Agent and DHCP Relay Agent Option 82 introductory information, see the [DHCP Feature Overview and Configuration Guide](#).

Syntax `ip dhcp-relay agent-option remote-id <remote-id>`
`no ip dhcp-relay agent-option remote-id`

Parameter	Description
<code><remote-id></code>	An alphanumeric (ASCII) string, 1 to 63 characters in length. Additional characters allowed are hyphen (-), underscore (_) and hash (#). Spaces are not allowed.

Default The Remote ID is set to the device's MAC address by default.

Mode Interface Configuration for VLAN, Eth, WWAN, and bridge interfaces and 802.1Q sub-interfaces.

Usage notes The Remote ID sub-option is included in the DHCP Relay Agent Option 82 field of relayed client DHCP packets if:

- DHCP Relay Agent Option 82 is enabled ([ip dhcp-relay agent-option](#)), and
- DHCP Relay Agent is enabled on the device ([service dhcp-relay](#))

Examples To set the Remote ID to myid for client DHCP packets received on eth1, use the commands:

```
awplus# configure terminal
awplus(config)# interface eth1
awplus(config-if)# ip dhcp-relay agent-option remote-id myid
```

To remove the Remote ID specified for eth1, use the commands:

```
awplus# configure terminal
awplus(config)# interface eth1
awplus(config-if)# no ip dhcp-relay agent-option remote-id
```

Related commands [ip dhcp-relay agent-option](#)
[ip dhcp-relay agent-option checking](#)
[show ip dhcp-relay](#)

ip dhcp-relay information policy

Overview This command sets the policy for how the DHCP relay deals with packets arriving from the client that contain DHCP Relay Agent Option 82 information.

If the command **ip dhcp-relay agent-option** has not been configured, then this command has no effect at all - no alteration is made to Option 82 information in packets arriving from the client side.

However, if the command **ip dhcp-relay agent-option** has been configured, this command modifies how the DHCP relay service deals with cases where the packet arriving from the client side already contains DHCP Relay Agent Option 82 information.

This command sets the action that the DHCP relay should take when a received DHCP client request contains DHCP Relay Agent Option 82 information.

By default, the DHCP Relay Agent replaces any existing DHCP Relay Agent Option 82 field with its own DHCP Relay Agent field. This is equivalent to the functionality of the **replace** parameter.

The **no** variant of this command returns the policy to the default behavior - i.e. replacing the existing DHCP Relay Agent Option 82 field.

For DHCP Relay Agent and DHCP Relay Agent Option 82 introductory information, see the [DHCP Feature Overview and Configuration Guide](#).

NOTE: The DHCP-relay service might alter the content of the DHCP Relay Agent Option 82 field, if the commands [ip dhcp-relay agent-option](#) and [ip dhcp-relay information policy](#) have been configured.

Syntax

```
ip dhcp-relay information policy {append|drop|keep|replace}  
no ip dhcp-relay information policy
```

Parameter	Description
append	The DHCP Relay Agent appends the DHCP Relay Agent Option 82 field of the packet with its own DHCP Relay Agent Option 82 details.
drop	The DHCP Relay Agent discards the packet.
keep	The DHCP Relay Agent forwards the packet without altering the DHCP Relay Agent Option 82 field.
replace	The DHCP Relay Agent replaces the existing DHCP Relay Agent details in the DHCP Relay Agent Option 82 field with its own details before forwarding the packet.

Mode Interface Configuration for VLAN, Eth, WWAN, and bridge interfaces and 802.1Q sub-interfaces.

Examples To make the DHCP Relay Agent listening on eth1 drop any client requests that already contain DHCP Relay Agent Option 82 information, use the commands:

```
awplus# configure terminal
awplus(config)# interface eth1
awplus(config-if)# ip dhcp-relay information policy drop
```

To reset the DHCP relay information policy to the default policy for interface eth1, use the commands:

```
awplus# configure terminal
awplus(config)# interface eth1
awplus(config-if)# no ip dhcp-relay information policy
```

Related commands

- [ip dhcp-relay agent-option](#)
- [ip dhcp-relay agent-option checking](#)
- [service dhcp-server](#)

ip dhcp-relay maxhops

Overview This command sets the hop count threshold for discarding BOOTP messages. When the hops field in a BOOTP message exceeds the threshold, the DHCP Relay Agent discards the BOOTP message. The hop count threshold is set to 10 hops by default.

Use the **no** variant of this command to reset the hop count to the default.

For DHCP Relay Agent and DHCP Relay Agent Option 82 introductory information, see the [DHCP Feature Overview and Configuration Guide](#).

Syntax `ip dhcp-relay maxhops <1-255>`
`no ip dhcp-relay maxhops`

Parameter	Description
<1-255>	The maximum hop count value.

Default The default hop count threshold is 10 hops.

Mode Interface Configuration for VLAN, Eth, WWAN, and bridge interfaces and 802.1Q sub-interfaces.

Example To set the maximum number of hops to 5 for packets received on interface eth1, use the commands:

```
awplus# configure terminal
awplus(config)# interface eth1
awplus(config-if)# ip dhcp-relay maxhops 5
```

Related commands [service dhcp-relay](#)

ip dhcp-relay max-message-length

Overview This command applies when the device is acting as a DHCP Relay Agent and DHCP Relay Agent Option 82 insertion is enabled. It sets the maximum DHCP message length (in bytes) for the DHCP packet with its DHCP Relay Agent Option 82 data inserted. From this value it calculates the maximum packet size that it will accept at its input. Packets that arrive greater than this value will be dropped.

The **no** variant of this command sets the maximum message length to its default of 1400 bytes.

For DHCP Relay Agent and DHCP Relay Agent Option 82 introductory information, see the [DHCP Feature Overview and Configuration Guide](#).

Syntax `ip dhcp-relay max-message-length <548-1472>`
`no ip dhcp-relay max-message-length`

Parameter	Description
<548-1472>	The maximum DHCP message length (this is the message header plus the inserted DHCP option fields in bytes).

Default The default is 1400 bytes.

Mode Interface Configuration for VLAN, Eth, WWAN, and bridge interfaces and 802.1Q sub-interfaces.

Usage notes When a DHCP Relay Agent (that has DHCP Relay Agent Option 82 insertion enabled) receives a request packet from a DHCP client, it will append the DHCP Relay Agent Option 82 component data, and forward the packet to the DHCP server. The DHCP client will sometimes issue packets containing pad option fields that can be overwritten with Option 82 data.

Where there are insufficient pad option fields to contain all the DHCP Relay Agent Option 82 data, the DHCP Relay Agent will increase the packet size to accommodate the DHCP Relay Agent Option 82 data. If the new (increased) packet size exceeds that defined by the **maximum-message-length** parameter, then the DHCP Relay Agent will drop the packet.

NOTE: Before setting this command, you must first run the `ip dhcp-relay agent-option` command. This will allow the DHCP Relay Agent Option 82 fields to be appended.

Example To set the maximum DHCP message length to 1200 bytes for packets arriving in interface eth1, use the commands:

```
awplus# configure terminal
awplus(config)# interface eth1
awplus(config-if)# ip dhcp-relay max-message-length 1200
```

To reset the maximum DHCP message length to the default of 1400 bytes for packets arriving in interface eth1, use the commands:

```
awplus# configure terminal
awplus(config)# interface eth1
awplus(config-if)# no ip dhcp-relay max-message-length
```

Related commands [service dhcp-relay](#)

ip dhcp-relay server-address

Overview This command adds a DHCP server for the DHCP Relay Agent to forward client DHCP packets to on a particular interface. You can add up to five DHCP servers on each device interface that the DHCP Relay Agent is listening on.

The **no** variant of this command deletes the specified DHCP server from the list of servers available to the DHCP relay agent.

The **no ip dhcp-relay** command removes all DHCP relay settings from the interface.

For DHCP Relay Agent and DHCP Relay Agent Option 82 introductory information, see the [DHCP Feature Overview and Configuration Guide](#).

Syntax `ip dhcp-relay server-address {<ipv4-address>|<ipv6-address>
<server-interface>}`
`no ip dhcp-relay server-address {<ipv4-address>|<ipv6-address>
<server-interface>}`
`no ip dhcp-relay`

Parameter	Description
<code><ipv4-address></code>	Specify the IPv4 address of the DHCP server for the DHCP Relay Agent to forward client DHCP packets to, in dotted decimal notation. The IPv4 address uses the format A.B.C.D.
<code><ipv6-address></code>	Specify the IPv6 address of the DHCPv6 server for the DHCPv6 Relay Agent to forward client DHCP packets to, in hexadecimal notation.
<code><server-interface></code>	Specify the interface name of the DHCPv6 server. It is only required for a DHCPv6 server with an IPv6 address.

Mode Interface Configuration for VLAN, Eth, WWAN, and bridge interfaces and 802.1Q sub-interfaces.

Usage notes For a DHCP server with an IPv6 address you must specify the interface for the DHCP server. See examples below for configuration differences between IPv4 and IPv6 DHCP relay servers.

See also the [service dhcp-relay](#) command to enable the DHCP Relay Agent on your device. The [ip dhcp-relay server-address](#) command defines a relay destination on an interface on the device, needed by the DHCP Relay Agent to relay DHCP client packets to a DHCP server.

Examples: DHCP for IPv4 To enable the DHCP Relay Agent to relay DHCP packets on interface eth1 to the DHCP server with the IPv4 address 192.0.2.200, use the commands:

```
awplus# configure terminal
awplus(config)# service dhcp-relay
awplus(config)# interface eth1
awplus(config-if)# ip dhcp-relay server-address 192.0.2.200
```

To remove the DHCP server with the IPv4 address 192.0.2.200 from the list of servers available to the DHCP Relay Agent on interface eth1, use the commands:

```
awplus# configure terminal
awplus(config)# interface eth1
awplus(config-if)# no ip dhcp-relay server-address 192.0.2.200
```

Examples: DHCPv6 To enable the DHCP Relay Agent on your device to relay DHCP packets on interface eth1.2 to the DHCP server with the IPv6 address 2001:0db8:010d::1 on interface eth1.4, use the commands:

```
awplus# configure terminal
awplus(config)# service dhcp-relay
awplus(config)# interface eth1.2
awplus(config-if)# ip dhcp-relay server-address
2001:0db8:010d::1 eth1.4
```

To remove the DHCP server with the IPv6 address 2001:0db8:010d::1 on interface eth1.4 from the list of servers available to the DHCP Relay Agent on interface eth1.2, use the commands:

```
awplus# configure terminal
awplus(config)# interface eth1.2
awplus(config-if)# no ip dhcp-relay server-address
2001:0db8:010d::1 eth1.4
```

Example: disabling DHCP relay To disable DHCP relay on eth1, use the commands:

```
awplus# configure terminal
awplus(config)# interface eth1
awplus(config-if)# no ip dhcp-relay
```

Related commands [service dhcp-relay](#)

ip dhcp-relay use-client-side-address

Overview Use this command to configure DHCP-Relay to use the client-side interface (that is the interface receiving the DHCP client packets) IP address as the source address of the relayed DHCP packets.

Use the **no** variant of this command to disable the use of the client-side interface IP address as the source IP address for relayed DHCP packets.

Syntax `ip dhcp-relay use-client-side-address`
`no ip dhcp-relay use-client-side-address`

Parameter	Description
<code>use-client-side-address</code>	Use the client side interface IP address as the source IP address for relayed DHCP packets.

Default By default, the server-side interface IP address is used as the source IP address of DHCP relayed packets.

Mode Global Configuration

Usage notes In most cases, there are filters placed between the DHCP relay and DHCP server which only allow DHCP packets from the client subnet to the server and back. This command allows you to configure the DHCP relay so that the relay will use the IP address of the interface **receiving** clients' DHCP requests to be used as the source IP address of the relayed DHCP packets.

Example To configure the client-side IP address as the source IP address of DHCP relayed packets, use the following commands:

```
awplus# configure terminal
awplus(config)# ip dhcp-relay use-client-side-address
```

Output Figure 54-1: Example output from **show ip dhcp-relay**

The second line of the display output shows the status of the client-side address being enabled as the source IP address.

```
awplus#sh ip dhcp-relay
DHCP Relay Service is enabled
Use of client side address as source address is enabled
...
```

Related commands [ip dhcp-relay server-address](#)

Command changes Version 5.4.9-0.7: command added

lease

Overview This command sets the expiration time for a leased address for the DHCP address pool you are configuring. The time set by the days, hours, minutes and seconds is cumulative. The minimum total lease time that can be configured is 20 seconds. The maximum total lease time that can be configured is 120 days.

Note that if you add a user-defined option 51 using the `option` command, then you will override any settings created with this command. Option 51 specifies a lease time of 1 day.

Use the **infinite** parameter to set the lease expiry time to infinite (leases never expire).

Use the **no** variant of this command to return the lease expiration time back to the default of one day.

Syntax `lease <days> <hours> <minutes> [<seconds>]`
`lease infinite`
`no lease`

Parameter	Description
<code><days></code>	The number of days, from 0 to 120, that the lease expiry time is configured for. Default: 1
<code><hours></code>	The number of hours, from 0 to 24, that the lease expiry time is configured for. Default: 0
<code><minutes></code>	The number of minutes, from 0 to 60, the lease expiry time is configured for. Default: 0
<code><seconds></code>	The number of seconds, from 0 to 60, the lease expiry time is configured for.
<code>infinite</code>	The lease never expires.

Default The default lease time is 1 day.

Mode DHCP Configuration

Examples To set the lease expiration time for address pool P2 to 35 minutes, use the commands:

```
awplus# configure terminal
awplus(config)# ip dhcp pool P2
awplus(dhcp-config)# lease 0 0 35
```

To set the lease expiration time for the address pool `Nerv_Office` to 1 day, 5 hours, and 30 minutes, use the commands:

```
awplus# configure terminal
awplus(config)# ip dhcp pool Nerv_Office
awplus(dhcp-config)# lease 1 5 30
```

To set the lease expiration time for the address pool `P3` to 20 seconds, use the commands:

```
awplus# configure terminal
awplus(config)# ip dhcp pool P3
awplus(dhcp-config)# lease 0 0 0 20
```

To set the lease expiration time for the pool to never expire, use the command:

```
awplus(dhcp-config)# lease infinite
```

To return the lease expiration time to the default of one day, use the command:

```
awplus(dhcp-config)# no lease
```

Related commands

- [option](#)
- [service dhcp-server](#)
- [short-lease-threshold](#)

network (DHCP)

Overview This command sets the network (subnet) that the DHCP address pool applies to. The **no** variant of this command removes the network (subnet) from the DHCP address pool.

Syntax

```
network  
{<ip-subnet-address/prefix-length>|<ip-subnet-address/mask>}  
no network
```

Parameter	Description
<i><ip-subnet-address/prefix-length></i>	The IPv4 subnet address in dotted decimal notation followed by the prefix length in slash notation.
<i><ip-subnet-address/mask></i>	The IPv4 subnet address in dotted decimal notation followed by the subnet mask in dotted decimal notation.

Mode DHCP Configuration

Usage notes This command will fail if it would make existing ranges invalid. For example, if they do not lie within the new network you are configuring.

The **no** variant of this command will fail if ranges still exist in the pool. You must remove all ranges in the pool before issuing a **no network** command to remove a network from the pool.

Examples To configure a network for the address pool P2, where the subnet is 192.0.2.5 and the mask is 255.255.255.0, use the commands:

```
awplus# configure terminal  
awplus(config)# ip dhcp pool P2  
awplus(dhcp-config)# network 192.0.2.5/24
```

or you can use dotted decimal notation instead of slash notation for the subnet-mask:

```
awplus# configure terminal  
awplus(config)# ip dhcp pool P2  
awplus(dhcp-config)# network 192.0.2.5 255.255.255.0
```

Related commands [service dhcp-server](#)
[subnet-mask](#)

next-server

Overview This command sets the next server address for a DHCP server pool. It is the address of the next server that the client should use in its bootstrap process.

The **no** variant of this command removes the next server address from the DHCP address pool.

Syntax `next-server <ip-address>`
`no next-server`

Parameter	Description
<code><ip-address></code>	The server IP address, entered in dotted decimal notation.

Mode DHCP Configuration

Example To set the next-server address for the address pool P2, use the commands:

```
awplus# configure terminal
awplus(config)# ip dhcp pool P2
awplus(dhcp-config)# next-server 192.0.2.2
```

option

Overview This command adds a user-defined option to the DHCP address pool you are configuring. For the **hex**, **integer**, and **flag** option types, if the option already exists, the new option overwrites the existing option's value. Options with an **ip** type can hold a list of IP addresses or masks (i.e. entries that have the A.B.C.D address format), so if the option already exists in the pool, then the new IP address is added to the list of existing IP addresses.

Options with the same number as one of the pre-defined options override the standard option definition. The pre-defined options use the option numbers 1, 3, 6, 15, and 51.

The **no** variant of this command removes the specified user-defined option from the DHCP pool, or all user-defined options from the DHCP pool.

Syntax `option [<1-254>|<option-name>] <option-value>`
`no option [<1-254>|<option-value>]`

Parameter	Description								
<1-254>	The option number of the option. Options with the same number as one of the standard options overrides the standard option definition.								
<option-name>	Option name associated with the option.								
<option-value>	The option value. You must specify a value that is appropriate to the option type: <table border="1" data-bbox="710 1261 1423 1751"> <tbody> <tr> <td>hex</td> <td>A hexadecimal string. Valid characters are the numbers 0–9 and letters a–f. Embedded spaces are not valid. The string must be an even number of characters, from 2 and 256 characters long.</td> </tr> <tr> <td>ip</td> <td>An IPv4 address or mask that has the dotted decimal A.B.C.D notation. To create a list of IP addresses, you must add each IP address individually using the option command multiple times.</td> </tr> <tr> <td>integer</td> <td>A number from 0 to 4294967295.</td> </tr> <tr> <td>flag</td> <td>A value of either true, on, or enabled to set the flag, or false, off or disabled to unset the flag.</td> </tr> </tbody> </table>	hex	A hexadecimal string. Valid characters are the numbers 0–9 and letters a–f. Embedded spaces are not valid. The string must be an even number of characters, from 2 and 256 characters long.	ip	An IPv4 address or mask that has the dotted decimal A.B.C.D notation. To create a list of IP addresses, you must add each IP address individually using the option command multiple times.	integer	A number from 0 to 4294967295.	flag	A value of either true, on, or enabled to set the flag, or false, off or disabled to unset the flag.
hex	A hexadecimal string. Valid characters are the numbers 0–9 and letters a–f. Embedded spaces are not valid. The string must be an even number of characters, from 2 and 256 characters long.								
ip	An IPv4 address or mask that has the dotted decimal A.B.C.D notation. To create a list of IP addresses, you must add each IP address individually using the option command multiple times.								
integer	A number from 0 to 4294967295.								
flag	A value of either true, on, or enabled to set the flag, or false, off or disabled to unset the flag.								

Mode DHCP Configuration

Examples To add the ASCII-type option named `tftp-server-name` to the pool P2 and give the option the value `server1`, use the commands:

```
awplus# configure terminal
awplus(config)# ip dhcp pool P2
awplus(dhcp-config)# option tftp-server-name server1
```

To add the hex-type option named `tcpip-node-type` to the pool P2 and give the option the value `08af`, use the commands:

```
awplus# configure terminal
awplus(config)# ip dhcp pool P2
awplus(dhcp-config)# option tcpip-node-type 08af
```

To add multiple IP addresses for the ip-type option 175, use the command:

```
awplus(dhcp-config)# option 175 192.0.2.6
awplus(dhcp-config)# option 175 192.0.2.12
awplus(dhcp-config)# option 175 192.0.2.33
```

To add the option 179 to a pool, and give the option the value `123456`, use the command:

```
awplus(dhcp-config)# option 179 123456
```

To add a user-defined flag option with the name `perform-router-discovery`, use the command:

```
awplus(dhcp-config)# option perform-router-discovery yes
```

To clear all user-defined options from a DHCP address pool, use the command:

```
awplus(dhcp-config)# no option
```

To clear a user-defined option, named `tftp-server-name`, use the command:

```
awplus(dhcp-config)# no option tftp-server-name
```

**Related
commands**

[dns-server](#)

[ip dhcp option](#)

[lease](#)

[service dhcp-server](#)

[show ip dhcp pool](#)

probe enable

Overview Use this command to enable lease probing for a DHCP pool. Probing is used by the DHCP server to check if an IP address it wants to lease to a client is already being used by another host.

The **no** variant of this command disables probing for a DHCP pool.

Syntax probe enable
no probe enable

Default Probing is enabled by default.

Mode DHCP Pool Configuration

Examples To enable probing for pool P2, use the commands:

```
awplus# configure terminal
awplus(config)# ip dhcp pool P2
awplus(dhcp-config)# probe enable
```

To disable probing for pool P2, use the commands:

```
awplus# configure terminal
awplus(config)# ip dhcp pool P2
awplus(dhcp-config)# no probe enable
```

Related commands

- [ip dhcp pool](#)
- [probe packets](#)
- [probe timeout](#)
- [probe type](#)
- [show ip dhcp pool](#)

probe packets

Overview Use this command to specify the number of packets sent for each lease probe. Lease probing is configured on a per-DHCP pool basis. When set to 0 probing is effectively disabled.

The **no** variant of this command sets the number of probe packets sent to the default of 5.

Syntax `probe packets <0-10>`
`no probe packets`

Parameter	Description
<0-10>	The number of probe packets sent.

Default The default is 5.

Mode DHCP Pool Configuration

Examples To set the number of probe packets to 2 for pool P2, use the commands:

```
awplus# configure terminal
awplus(config)# ip dhcp pool P2
awplus(dhcp-config)# probe packets 2
```

To set the number of probe packets to the default 5 for pool P2, use the commands:

```
awplus# configure terminal
awplus(config)# ip dhcp pool P2
awplus(dhcp-config)# no probe packets
```

Related commands [probe enable](#)
[probe timeout](#)
[probe type](#)
[show ip dhcp pool](#)

probe timeout

Overview Use this command to set the timeout value in milliseconds that the server waits for a response after each probe packet is sent. Lease probing is configured on a per-DHCP pool basis.

The **no** variant of this command sets the probe timeout value to the default setting, 200 milliseconds.

Syntax `probe timeout <50-5000>`
`no probe timeout`

Parameter	Description
<code><50-5000></code>	Timeout interval in milliseconds.

Default The default timeout interval is 200 milliseconds.

Mode DHCP Pool Configuration

Examples To set the probe timeout value to 500 milliseconds for pool P2, use the commands:

```
awplus# configure terminal
awplus(config)# ip dhcp pool P2
awplus(dhcp-config)# probe timeout 500
```

To set the probe timeout value for pool P2 to the default, 200 milliseconds, use the commands:

```
awplus# configure terminal
awplus(config)# ip dhcp pool P2
awplus(dhcp-config)# no probe timeout
```

Related commands [probe enable](#)
[probe packets](#)
[probe type](#)
[show ip dhcp pool](#)

probe type

Overview Use this command to set the probe type for a DHCP pool. The probe type specifies how the DHCP server checks whether an IP address is being used by other hosts, referred to as lease probing. If **arp** is specified, the server sends an ARP request to determine if an address is in use. If **ping** is specified, the server will send an ICMP Echo Request (ping).

The **no** variant of this command sets the probe type to the default setting, ping.

Syntax probe type {arp|ping}
no probe type

Parameter	Description
arp	Probe using ARP.
ping	Probe using ping.

Default The default probe type is ping.

Mode DHCP Pool Configuration

Examples To set the probe type to arp for the pool P2, use the commands:

```
awplus# configure terminal
awplus(config)# ip dhcp pool P2
awplus(dhcp-config)# probe type arp
```

To set the probe type for the pool P2 to the default, ping, use the commands:

```
awplus# configure terminal
awplus(config)# ip dhcp pool P2
awplus(dhcp-config)# no probe type
```

Related commands

- [ip dhcp pool](#)
- [probe enable](#)
- [probe packets](#)
- [probe timeout](#)
- [show ip dhcp pool](#)

range

Overview This command adds an address range to the DHCP address pool you are configuring. The DHCP server responds to client requests received from the pool's network. It assigns an IP addresses within the specified range. The IP address range must lie within the network. You can add multiple address ranges and individual IP addresses for a DHCP pool by using this command multiple times.

The **no** variant of this command removes an address range from the DHCP pool. Use the **no range all** command to remove all address ranges from the DHCP pool.

Syntax

```
range <ip-address> [<ip-address>]  
no range <ip-address> [<ip-address>]  
no range all
```

Parameter	Description
<ip-address>	IPv4 address range for DHCP clients, in dotted decimal notation. The first IP address is the low end of the range, the second IP address is the high end. Specify only one IP address to add an individual IP address to the address pool.

Mode DHCP Configuration

Examples To add an address range of 192.0.2.5 to 192.0.2.16 to the pool Nerv_Office, use the command:

```
awplus# configure terminal  
awplus(config)# ip dhcp pool Nerv_Office  
awplus(dhcp-config)# range 192.0.2.5 192.0.2.16
```

To add the individual IP address 192.0.2.2 to a pool, use the command:

```
awplus(dhcp-config)# range 192.0.2.2
```

To remove all address ranges from a pool, use the command:

```
awplus(dhcp-config)# no range all
```

Related commands

- [ip dhcp pool](#)
- [service dhcp-server](#)
- [show ip dhcp pool](#)

route

Overview This command allows the DHCP server to provide static routes to clients.

Syntax `route A.B.C.D/M A.B.C.D {both|opt249|rfc3442}`

Parameter	Description
A.B.C.D/M	Subnet for the route
A.B.C.D	Next hop for the route
both	opt249 and rfc3442
opt249	Classless static route option for DHCP
rfc3442	Classless static route option for DHCP

Mode DHCP Configuration

Examples To distribute static routes for route 0.0.0.0/0 whose next hop is 192.16.1.1 to clients using both opt249 and rfc3442, use the command:

```
awplus# configure terminal
awplus(config)# ip dhcp pool pubic
awplus(dhcp-config)# route 0.0.0.0/0 192.16.1.1 both
```

Related commands [ip dhcp pool](#)

service dhcp-relay

Overview This command enables the DHCP Relay Agent on the device. However, on a given IP interface, no DHCP forwarding takes place until at least one DHCP server is specified to forward/relay all clients' DHCP packets to.

The **no** variant of this command disables the DHCP Relay Agent on the device for all interfaces.

Syntax `service dhcp-relay`
`no service dhcp-relay`

Mode Global Configuration

Usage notes A maximum number of 400 DHCP Relay Agents (one per interface) can be configured on the device. Once this limit has been reached, any further attempts to configure DHCP Relay Agents will not be successful.

Default The DHCP-relay service is enabled by default.

Examples To enable the DHCP relay global function, use the commands:

```
awplus# configure terminal
awplus(config)# service dhcp-relay
```

To disable the DHCP relay global function, use the commands:

```
awplus# configure terminal
awplus(config)# no service dhcp-relay
```

Related commands

- [ip dhcp-relay agent-option](#)
- [ip dhcp-relay agent-option checking](#)
- [ip dhcp-relay information policy](#)
- [ip dhcp-relay maxhops](#)
- [ip dhcp-relay server-address](#)

service dhcp-server

Overview This command enables the DHCP server on your device. The server then listens for DHCP requests on all IP interfaces. It will not run if there are no IP interfaces configured.

The **no** variant of this command disables the DHCP server.

Syntax `service dhcp-server`
`no service dhcp-server`

Mode Global Configuration

Example To enable the DHCP server, use the commands:

```
awplus# configure terminal
awplus(config)# service dhcp-server
```

Related commands [ip dhcp pool](#)
[show ip dhcp server summary](#)
[subnet-mask](#)

short-lease-threshold

Overview Use this command to configure a short lease threshold.

Use the **no** variant of this command to return the short lease threshold to the default of one minute.

Syntax `short-lease-threshold <hours> <minutes>`
`no short-lease-threshold`

Parameter	Description
<code><hours></code>	The number of hours, from 0 to 24.
<code><minutes></code>	The number of minutes, from 0 to 60.

Default 1 minute.

Mode DHCP Configuration

Usage notes DHCP leases need to be backed up in NVS so that when the DHCP server reboots or goes through a power cycle it won't lose all the knowledge of these leases.

Some networks have a high number of mobile devices repeatedly requesting DHCP leases every few seconds before their existing lease expires. This can happen for example, when mobile devices move in and out of a Wi-Fi zone or when Wi-Fi signal strength changes. This means the same IP address can have multiple lease entries which can take up unnecessary backup file space.

The **short-lease-threshold** command allows you to configure the threshold for a short lease, from 1 minute to 24 hours. Any lease less than the threshold is deemed to be a short lease and will NOT be backed up to NVS.

This is useful if you have:

- limited backup file space, and
- you don't need to restore leases after a device reboot or power cycle

Example To set the short lease threshold for address pool P2 to 40 minutes, use the following commands:

```
awplus# configure terminal
awplus(config)# ip dhcp pool P2
awplus(dhcp-config)# short-lease-threshold 0 40
```

To set the short lease threshold for address pool Nerv_Office to 5 hours and 35 minutes, use the following commands:

```
awplus# configure terminal
awplus(config)# ip dhcp pool Nerv_Office
awplus(dhcp-config)# short-lease-threshold 5 35
```

To return the short lease threshold to the default of one minute, use the following commands:

```
awplus# configure terminal
awplus(config)# no short-lease-threshold
```

Related commands [lease](#)

Command changes Version 5.4.8-2.1: command added

show counter dhcp-client

Overview This command shows counters for the DHCP client on your device.
For information on filtering and saving command output, see the [“Getting Started with AlliedWare Plus” Feature Overview and Configuration Guide](#).

Syntax `show counter dhcp-client`

Mode User Exec and Privileged Exec

Example To display the message counters for the DHCP client on your device, use the command:

```
awplus# show counter dhcp-client
```

Output Figure 54-2: Example output from the **show counter dhcp-client** command

```
show counter dhcp-client
DHCPDISCOVER out      ..... 10
DHCPREQUEST out       ..... 34
DHCPCDECLINE out      ..... 4
DHCPRELEASE out       ..... 0
DHCPPOFFER in         ..... 22
DHCPACK in             ..... 18
DHCPNAK in             ..... 0
```

Table 1: Parameters in the output of the **show counter dhcp-client** command

Parameter	Description
DHCPDISCOVER out	The number of DHCP Discover messages sent by the client.
DHCPREQUEST out	The number of DHCP Request messages sent by the client.
DHCPCDECLINE out	The number of DHCP Decline messages sent by the client.
DHCPRELEASE out	The number of DHCP Release messages sent by the client.
DHCPPOFFER in	The number of DHCP Offer messages received by the client.
DHCPACK in	The number of DHCP Acknowledgement messages received by the client.
DHCPNAK in	The number of DHCP Negative Acknowledgement messages received by the client.

Related commands [ip address dhcp](#)

show counter dhcp-relay

Overview This command shows counters for the DHCP Relay Agent on your device.

For information on filtering and saving command output, see the [“Getting Started with AlliedWare Plus” Feature Overview and Configuration Guide](#).

Syntax show counter dhcp-relay

Syntax (VRF-lite) show counter dhcp-relay [vrf <vrf-name>|global]

Parameter	Description
vrf	Display the output for a VRF instance
<vrf-name>	The name of the specific VRF instance.
global	Display the output for the Global VRF instance

Mode User Exec and Privileged Exec

Examples To display counters for the DHCP Relay Agent on your device, use the following command:

```
awplus# show counter dhcp-relay
```

Output Figure 54-3: Example output from the **show counter dhcp-relay** command

```
awplus#show counter dhcp-relay

DHCP relay counters
Requests In           ..... 4
Replies In           ..... 4
Relayed To Server    ..... 4
Relayed To Client    ..... 4
Out To Server Failed ..... 0
Out To Client Failed ..... 0
Invalid hlen         ..... 0
Bogus giaddr         ..... 0
Corrupt Agent Option ..... 0
Missing Agent Option ..... 0
Bad Circuit ID       ..... 0
Missing Circuit ID    ..... 0
Bad Remote ID        ..... 0
Missing Remote ID    ..... 0
Option Insert Failed ..... 0
DHCPv6 Requests In  ..... 0
DHCPv6 Replies In    ..... 0
DHCPv6 Relayed to Server ..... 0
DHCPv6 Relayed to Client ..... 0
```

Output (VRF-lite) Figure 54-4: Example output from the **show counter dhcp-relay** command for VRF instance red

```
DHCP relay counters

[VRF red]
Requests In ..... 4
Replies In ..... 4
Relayed To Server ..... 4
Relayed To Client ..... 4
Out To Server Failed ..... 0
Out To Client Failed ..... 0
Invalid hlen ..... 0
Bogus giaddr ..... 0
Corrupt Agent Option ..... 0
Missing Agent Option ..... 0
Bad Circuit ID ..... 0
Missing Circuit ID ..... 0
Option Insert Failed ..... 0
```

Parameter	Description
Requests In	The number of DHCP Request messages received from clients.
Replies In	The number of DHCP Reply messages received from servers.
Relayed To Server	The number of DHCP Request messages relayed to servers.
Relayed To Client	The number of DHCP Reply messages relayed to clients.
Out To Server Failed	The number of failures when attempting to send request messages to servers. This is an internal debugging counter.
Out To Client Failed	The number of failures when attempting to send reply messages to clients. This is an internal debugging counter.
Invalid hlen	The number of incoming messages dropped due to an invalid hlen field.
Bogus giaddr	The number of incoming DHCP Reply messages dropped due to the bogus giaddr field.
Corrupt Agent Option	The number of incoming DHCP Reply messages dropped due to a corrupt relay agent information option field. Note that Agent Option counters only increment on errors occurring if the <code>ip dhcp-relay agent-option</code> command is configured for an interface. Messages generating the errors are only dropped if the <code>ip dhcp-relay agent-option checking</code> command is configured on the interface as well as the <code>ip dhcp-relay agent-option</code> command.

Parameter	Description
Missing Agent Option	The number of incoming DHCP Reply messages dropped due to a missing relay agent information option field. Note that Agent Option counters only increment on errors occurring if the <code>ip dhcp-relay agent-option</code> command is configured for an interface. Messages generating the errors are only dropped if the <code>ip dhcp-relay agent-option checking</code> command is configured on the interface as well as the <code>ip dhcp-relay agent-option</code> command.
Bad Circuit ID	The number of incoming DHCP Reply messages dropped due to a bad circuit ID. Note that Agent Option counters only increment on errors occurring if the <code>ip dhcp-relay agent-option</code> command is configured for an interface. Messages generating the errors are only dropped if the <code>ip dhcp-relay agent-option checking</code> command is configured on the interface as well as the <code>ip dhcp-relay agent-option</code> command.
Missing Circuit ID	The number of incoming DHCP Reply messages dropped due to a missing circuit ID. Note that Agent Option counters only increment on errors occurring if the <code>ip dhcp-relay agent-option</code> command is configured for an interface. Messages generating the errors are only dropped if the <code>ip dhcp-relay agent-option checking</code> command is configured on the interface as well as the <code>ip dhcp-relay agent-option</code> command.
Bad Remote ID	The number of incoming DHCP Reply messages dropped due to a bad remote ID. Note that Agent Option counters only increment on errors occurring if the <code>ip dhcp-relay agent-option</code> command is configured for an interface. Messages generating the errors are only dropped if the <code>ip dhcp-relay agent-option checking</code> command is configured on the interface as well as the <code>ip dhcp-relay agent-option</code> command.
Missing Remote ID	The number of incoming DHCP Reply messages dropped due to a missing remote ID. Note that Agent Option counters only increment on errors occurring if the <code>ip dhcp-relay agent-option</code> command is configured for an interface. Messages generating the errors are only dropped if the <code>ip dhcp-relay agent-option checking</code> command is configured on the interface as well as the <code>ip dhcp-relay agent-option</code> command.

Parameter	Description
Option Insert Failed	<p>The number of incoming DHCP Request messages dropped due to an error adding the DHCP Relay Agent information (option-82). This counter increments when:</p> <ul style="list-style-type: none"> the DHCP Relay Agent is set to drop packets with the DHCP Relay Agent Option 82 field already filled by another DHCP Relay Agent. This policy is set with the <code>ip dhcp-relay information policy</code> command. there is a packet error that stops the DHCP Relay Agent from being able to append the packet with its DHCP Relay Agent Information Option (Option 82) field.
<p>Note that the following parameters are only used on the Global VRF instance when DHCPv6 is running</p>	
DHCPv6 Requests In	The number of incoming DHCPv6 Request messages.
DHCPv6 Replies In	The number of incoming DHCPv6 Reply messages.
DHCPv6 Relayed to Server	The number of DHCPv6 messages relayed to the server.
DHCPv6 Relayed to Client	The number of DHCPv6 messages relayed to the client.

show counter dhcp-server

Overview This command shows counters for the DHCP server on your device.
For information on filtering and saving command output, see the [“Getting Started with AlliedWare Plus” Feature Overview and Configuration Guide](#).

Syntax `show counter dhcp-server`

Syntax (VRF-lite) `show counter dhcp-server [vrf <vrf-name>]`

Parameter	Description
vrf	Display the output for a VRF instance
<vrf-name>	The name of the specific VRF instance.

Mode User Exec and Privileged Exec

Example To display counters for the DHCP server on your device, use the command:

```
awplus# show counter dhcp-server
```

Output Figure 54-5: Example output from the **show counter dhcp-server** command

```
DHCP server counters
DHCPDISCOVER in      ..... 20
DHCPPREQUEST in     ..... 12
DHCPPDECLINE in      ..... 1
DHCPPRELEASE in      ..... 0
DHCPPINFORM in       ..... 0
DHCPOFFER out        ..... 8
DHCPPACK out         ..... 4
DHCPPNAK out         ..... 0
BOOTREQUEST in       ..... 0
BOOTREPLY out        ..... 0
```

Figure 54-6: Example output from the **show counter dhcp-server** command with VRFs configured

```

DHCP server counters[VRF: RED]
DHCPDISCOVER in          ..... 0
DHCPREQUEST in           ..... 7
DHCPCDECLINE in          ..... 0
DHCPRELEASE in           ..... 0
DHCPINFORM in            ..... 0
DHCPOFFER out            ..... 0
DHCPACK out              ..... 7
DHCPNAK out              ..... 0
BOOTREQUEST in           ..... 0
BOOTREPLY out            ..... 0
DHCPLEASEQUERY in        ..... 0
DHCPLEASEUNKNOWN out     ..... 0
DHCPLEASEACTIVE out      ..... 0
DHCPLEASEUNASSIGNED out  ..... 0

[VRF: GREEN]
DHCPDISCOVER in          ..... 0
DHCPREQUEST in           ..... 7
DHCPCDECLINE in          ..... 0
DHCPRELEASE in           ..... 0
DHCPINFORM in            ..... 0
DHCPOFFER out            ..... 0
DHCPACK out              ..... 7
DHCPNAK out              ..... 0
BOOTREQUEST in           ..... 0
BOOTREPLY out            ..... 0
DHCPLEASEQUERY in        ..... 0
DHCPLEASEUNKNOWN out     ..... 0
DHCPLEASEACTIVE out      ..... 0
DHCPLEASEUNASSIGNED out  ..... 0
    
```

Table 2: Parameters in the output of the **show counter dhcp-server** command

Parameter	Description
DHCPDISCOVER in	The number of Discover messages received by the DHCP server.
DHCPREQUEST in	The number of Request messages received by the DHCP server.
DHCPCDECLINE in	The number of Decline messages received by the DHCP server.
DHCPRELEASE in	The number of Release messages received by the DHCP server.
DHCPINFORM in	The number of Inform messages received by the DHCP server.
DHCPOFFER out	The number of Offer messages sent by the DHCP server.

Table 2: Parameters in the output of the **show counter dhcp-server** command

Parameter	Description
DHCPACK out	The number of Acknowledgement messages sent by the DHCP server.
DHCNPAK out	The number of Negative Acknowledgement messages sent by the DHCP server. The server sends these after receiving a request that it cannot fulfil because either there are no available IP addresses in the related address pool, or the request has come from a client that doesn't fit the network setting for an address pool.
BOOTREQUEST in	The number of bootp messages received by the DHCP server from bootp clients.
BOOTREPLY out	The number of bootp messages sent by the DHCP server to bootp clients.

Related commands

- [service dhcp-server](#)
- [show ip dhcp binding](#)
- [show ip dhcp server statistics](#)
- [show ip dhcp pool](#)
- [show ip dhcp server statistics](#)

show dhcp lease

Overview This command shows details about the leases that the DHCP client has acquired from a DHCP server for interfaces on the device.

For information on filtering and saving command output, see “Controlling “show” Command Output” in the “Getting Started with AlliedWare_Plus” Feature Overview and Configuration Guide.

Syntax `show dhcp lease [<interface>]`

Parameter	Description
<interface>	Interface name to display DHCP lease details for.

Mode User Exec and Privileged Exec

Example To show the current lease expiry times for all interfaces, use the command:

```
awplus# show dhcp lease
```

To show the current lease for vlan2, use the command:

```
awplus# show dhcp lease vlan2
```

Output Figure 54-7: Example output from the **show dhcp lease vlan1** command

```
Interface vlan1
-----
IP Address:                192.168.22.4
Expires:                   13 Mar 2022 20:10:19
Renew:                     13 Mar 2022 18:37:06
Rebind:                    13 Mar 2022 19:49:29
Server:
Options:
  subnet-mask              255.255.255.0
  routers                  19.18.2.100,12.16.2.17
  dhcp-lease-time          3600
  dhcp-message-type        5
  domain-name-servers      192.168.100.50,19.88.200.33
  dhcp-server-identifier   192.168.22.1
  domain-name              alliedtelesis.com
```

Related commands [ip address dhcp](#)

show ip dhcp binding

Overview This command shows the lease bindings that the DHCP server has allocated clients.

For information on filtering and saving command output, see the [“Getting Started with AlliedWare Plus” Feature Overview and Configuration Guide](#).

Syntax `show ip dhcp binding [<ip-address>|<address-pool>]`

Syntax (VRF-lite) `show ip dhcp binding [vrf <name>] [<ip-address>|<address-pool>]`

Parameter	Description
<code>vrf</code>	Display the output for a VRF instance
<code><name></code>	The name of the specific VRF instance.
<code><ip-address></code>	IPv4 address of a leased IP address, in dotted decimal notation. This displays the lease information for the specified IP address.
<code><address-pool></code>	Name of an address pool. This displays the lease information for all clients within the address pool.

Mode User Exec and Privileged Exec

Examples To display all leases for every client in all address pools, use the command:

```
awplus# show ip dhcp binding
```

To display the details for the leased IP address 172.16.2.16, use the command:

```
awplus# show ip dhcp binding 172.16.2.16
```

To display the leases from the address pool MyPool, use the command:

```
awplus# show ip dhcp binding MyPool
```

Output Figure 54-8: Example output from the **show ip dhcp binding** command

```
Pool 30_2_network Network 172.16.2.0/24
DHCP Client Entries
IP Address      ClientId                Type      Expiry
-----
172.16.2.100   0050.fc82.9ede         Dynamic   21 Jun 2021 19:02:58
172.16.2.101   000e.a6ae.7c14         Static    Infinite
172.16.2.102   000e.a6ae.7c4c         Static    Infinite
172.16.2.103   000e.a69a.ac91         Static    Infinite
172.16.2.104   00e0.189d.5e41         Static    Infinite
172.16.2.150   00e0.2b04.5800         Static    Infinite
172.16.2.167   4444.4400.35c3         Dynamic   21 Jun 2021 14:58:41
```

Output (VRF-lite) Figure 54-9: Example output from the **show ip dhcp binding** command for VRF instance red

```
[VRF: RED]Pool red_pool Network 192.168.1.0/24
DHCP Client Entries
IP Address      ClientId                Type      Expiry
-----
192.168.1.2    0000.cd38.00bf         Dynamic  2 Jun 2021 13:38:470
```

Related commands

- [clear ip dhcp binding](#)
- [ip dhcp pool](#)
- [lease](#)
- [range](#)
- [service dhcp-server](#)
- [show ip dhcp pool](#)

show ip dhcp pool

Overview This command displays the configuration details and system usage of the DHCP address pools configured on the device.

For information on filtering and saving command output, see the [“Getting Started with AlliedWare Plus” Feature Overview and Configuration Guide](#).

Syntax `show ip dhcp pool [<address-pool>]`

Parameter	Description
<address-pool>	Name of a specific address pool. This displays the configuration of the specified address pool only.

Mode User Exec and Privileged Exec

Example `awplus# show ip dhcp pool`

Output Figure 54-10: Example output from the **show ip dhcp pool** command

```
Pool p1 :
  network: 192.168.1.0/24
  address ranges:
    addr: 192.168.1.10 to 192.168.1.18
  static host addresses:
    addr: 192.168.1.12      MAC addr: 1111.2222.3333
  lease <days:hours:minutes:seconds> <1:0:0:0>
  subnet mask: 255.255.255.0 (pool's network mask)
  Probe:
    Status:      Enabled      [Enabled]
    Type:        ARP          [Ping]
    Packets:     2            [5]
    Timeout:    200 msec     [200]
  Dynamic addresses:
    Total:       8
    Leased:      2
    Utilization: 25.0 %
  Static host addresses:
    Total:       1
    Leased:      1
```

Output Figure 54-11: Example output from the **show ip dhcp pool** command with IP address 192.168.1.12 assigned to a VLAN interface on the device:

```
Pool p1 :
network: 192.168.1.0/24
address ranges:
  addr: 192.168.1.10 to 192.168.1.18
        (interface addr 192.168.1.12 excluded)
        (static host addr 192.168.1.12 excluded)
static host addresses:
  addr: 192.168.1.12      MAC addr: 1111.2222.3333
        (= interface addr, so excluded)
lease <days:hours:minutes:seconds> <1:0:0:0>
subnet mask: 255.255.255.0 (pool's network mask)
Probe:                               Default Values
  Status:      Enabled                [Enabled]
  Type:        ARP                    [Ping]
  Packets:     2                      [5]
  Timeout:     200 msec                [200]
Dynamic addresses:
  Total:       8
  Leased:      2
  Utilization: 25.0 %
Static host addresses:
  Total:       1
  Leased:      1
```

Output Figure 54-12: Example output from the **show ip dhcp pool** command with a host with MAC 0000.cd38.05f9 is registered as a static host by DHCP Framed IP Lease feature from AUTHD:

```

Pool p1 :
  network: 10.1.1.0/24
  address ranges:
    addr: 10.1.1.101 to 10.1.1.199
        (static host addr 10.1.1.122 excluded)
        (static host addr 10.1.1.111 excluded)
  static host addresses:
    addr: 10.1.1.122      MAC addr: 0000.1111.2222
    addr: 10.1.1.111      MAC addr: 0000.cd38.05f9
                          Netmask : 255.255.255.0
                          Gateway : 10.1.1.1
                          Lease   : 60 seconds
                          Added by AUTHD

  lease <1:0:0:0>
  subnet mask: 255.255.255.0 (pool's network mask)
  Probe:
    Status:      Enabled      [Enabled]
    Type:        Ping         [Ping]
    Packets:     5             [5]
    Timeout:     200 msec     [200]
  Dynamic addresses:
    Total:       97
    Leased:      1
    Utilization: 1.0 %
  Static host addresses:
    Total:       2
    Leased:      2
    
```

Table 3: Parameters in the output of the **show ip dhcp pool** command

Parameter	Description
Pool	Name of the pool.
network	Subnet and mask length of the pool.
address ranges	Individual IP addresses and address ranges configured for the pool. The DHCP server can offer clients an IP address from within the specified ranges only. Any of these addresses that match an interface address on the device, or a static host address configured in the pool, will be automatically excluded from the range, and a message to this effect will appear beneath the range entry.

Table 3: Parameters in the output of the **show ip dhcp pool** command (cont.)

Parameter	Description
static host addresses	The static host addresses configured on the pool. Each IP address is permanently assigned to the client with the matching MAC address. Any of these addresses that match an interface address on the device will be automatically excluded, and a message to this effect will appear beneath the static host entry.
lease <days:hours:minutes>	The lease duration for address allocated by this pool.
domain	The domain name sent by the pool to clients. This is the domain name that the client should use when resolving host names using DNS.
subnet mask	The subnet mask sent by the pool to clients.
Probe - Status	Whether lease probing is enabled or disabled.
Probe - Type	The lease probe type configured. Either ping or ARP.
Probe - Packets	The number of packets sent for each lease probe in the range 0 to 10.
Probe - Timeout	The timeout value in milliseconds to wait for a response after each probe packet is sent. In the range 50 to 5000.
dns servers	The DNS server addresses sent to by the pool to clients.
default-router(s)	The default router addresses sent by the pool to clients.
user-defined options	The list of user-defined options sent by the pool to clients.
Dynamic addresses- Total	The total number of IP addresses that have been configured in the pool for dynamic allocation to DHCP clients.
Dynamic addresses- Leased	The number of IP addresses in the pool that have been dynamically allocated (leased) to DHCP clients.
Dynamic addresses - Utilization	The percentage of IP addresses in the pool that are currently dynamically allocated to clients.
Static host addresses- Total	The number of static IP addresses configured in the pool for specific DHCP client hosts.
Static host addresses - Leased	The number of static IP addresses assigned to specific DHCP client hosts.

Related commands

- ip dhcp pool
- probe enable
- probe packets
- probe timeout
- probe type
- range
- service dhcp-server
- subnet-mask

show ip dhcp-relay

Overview This command shows the configuration of the DHCP Relay Agent on each interface.

For information on filtering and saving command output, see the [“Getting Started with AlliedWare Plus” Feature Overview and Configuration Guide](#).

Syntax `show ip dhcp-relay [interface <interface-name>]`

Syntax (VRF-lite) `show ip dhcp-relay [vrf <name>|global] [interface <interface-name>]`

Parameter	Description
<interface-name>	Name of a specific interface. This displays the DHCP configuration for the specified interface only.
vrf	Apply this command to a VRF instance.
<vrf-name>	The name of the VRF instance.
global	The Global VRF instance.

Mode User Exec and Privileged Exec

Example To display the DHCP Relay Agent’s configuration on the interface vlan2, use the command:

```
awplus# show ip dhcp-relay interface vlan2
```

Output Figure 54-13: Example output from the **show ip dhcp-relay** command

```
DHCP Relay Service is enabled

vlan2 is up, line protocol is up
Maximum hop count is 10
Insertion of Relay Agent Option is disabled
Checking of Relay Agent Option is disabled
The Remote Id string for Relay Agent Option is 0000.cd28.074c
Relay information policy is to append new relay agent
information
List of servers : 192.168.1.200
```

Output (VRF-lite) Figure 54-14: Example output from the **show ip dhcp-relay** command applied for VRF instance red

```
DHCP Relay Service is enabled

[VRF: red]
vlan2 is up, line protocol is up
Maximum hop count is 10
Maximum DHCP message length is 1400
Insertion of Relay Agent Option is enabled
Checking of Relay Agent Option is disabled
The Remote Id string for Relay Agent Option is 0000.cd28.074c
Relay Information policy is to replace existing relay agent
information
List of servers : 192.168.1.3
```

Related commands

- [ip dhcp-relay agent-option](#)
- [ip dhcp-relay agent-option checking](#)
- [ip dhcp-relay information policy](#)
- [ip dhcp-relay maxhops](#)
- [ip dhcp-relay server-address](#)

Command changes Version 5.4.6-2.1: VRF-lite support added.

show ip dhcp server statistics

Overview This command shows statistics related to the DHCP server.

You can display the server counters using the [show counter dhcp-server](#) command as well as with this command.

For information on filtering and saving command output, see the [“Getting Started with AlliedWare Plus” Feature Overview and Configuration Guide](#).

Syntax show ip dhcp server statistics

Syntax (VRF-lite) show ip dhcp server statistics [vrf <name>]

Parameter	Description
vrf	Display the output for a VRF instance
<name>	The name of the specific VRF instance.

Mode User Exec and Privileged Exec

Example To display the server statistics, use the command:

```
awplus# show ip dhcp server statistics
```

Output Figure 54-15: Example output from the **show ip dhcp server statistics** command

```
DHCP server counters
DHCPDISCOVER in      ..... 20
DHCYPREQUEST in     ..... 12
DHCPEDECLINE in     ..... 1
DHCYPRELEASE in     ..... 0
DHCPIFORM in        ..... 0
DHCPOFFER out       ..... 8
DHCPCACK out        ..... 4
DHCPCNAK out        ..... 0
BOOTREQUEST in      ..... 0
BOOTREPLY out       ..... 0
DHCPLEASEQUERY in   ..... 0
DHCPLEASEUNKNOWN out ..... 0
DHCPLEASEACTIVE out ..... 0
DHCPLEASEUNASSIGNED out ..... 0
```

Output (VRF-lite) Figure 54-16: Example output from the **show ip dhcp server statistics** command for VRF instance red

```

DHCP relay counters
[VRF: RED]
DHCPDISCOVER in          ..... 0
DHCPREQUEST in           ..... 7
DHCPDECLINE in           ..... 0
DHCPRELEASE in           ..... 0
DHCPINFORM in            ..... 0
DHCPPOFFER out           ..... 0
DHCPACK out              ..... 7
DHCPNAK out               ..... 0
BOOTREQUEST in           ..... 0
BOOTREPLY out             ..... 0
DHCPLEASEQUERY in        ..... 0
DHCPLEASEUNKNOWN out     ..... 0
DHCPLEASEACTIVE out      ..... 0
DHCPLEASEUNASSIGNED out  ..... 0
    
```

Parameter	Description
DHCPDISCOVER in	The number of Discover messages received by the DHCP server.
DHCPREQUEST in	The number of Request messages received by the DHCP server.
DHCPDECLINE in	The number of Decline messages received by the DHCP server.
DHCPRELEASE in	The number of Release messages received by the DHCP server.
DHCPINFORM in	The number of Inform messages received by the DHCP server.
DHCPOFFER out	The number of Offer messages sent by the DHCP server.
DHCPACK out	The number of Acknowledgement messages sent by the DHCP server.
DHCPNAK out	The number of Negative Acknowledgement messages sent by the DHCP server. The server sends these after receiving a request that it cannot fulfil because either there are no available IP addresses in the related address pool, or the request has come from a client that doesn't fit the network setting for an address pool.
BOOTREQUEST in	The number of bootp messages received by the DHCP server from bootp clients.

Parameter	Description
BOOTREPLY out	The number of bootp messages sent by the DHCP server to bootp clients.
DHCPLEASEQUERY in	The number of Lease Query messages received by the DHCP server from DHCP Relay Agents.
DHCPLEASEUNKNOWN out	The number of Lease Unknown messages sent by the DHCP server to DHCP Relay Agents.
DHCPLEASEACTIVE out	The number of Lease Active messages sent by the DHCP server to DHCP Relay Agents.
DHCPLEASEUNASSIGNED out	The number of Lease Unassigned messages sent by the DHCP server to DHCP Relay Agents.

Related commands

- [show counter dhcp-server](#)
- [service dhcp-server](#)
- [show ip dhcp binding](#)
- [show ip dhcp pool](#)

Command changes Version 5.5.1-1.1: **vrf <name>** parameter added

show ip dhcp server summary

Overview This command shows the current configuration of the DHCP server. This includes:

- whether the DHCP server is enabled
- whether the DHCP server is configured to ignore BOOTP requests
- whether the DHCP server is configured to support DHCP lease queries
- the details of any user-defined options
- a list of the names of all DHCP address pools currently configured

This show command does not include any configuration details of the address pools. You can display these using the [show ip dhcp pool](#) command.

For information on filtering and saving command output, see the [“Getting Started with AlliedWare Plus” Feature Overview and Configuration Guide](#).

Syntax `show ip dhcp server summary`

Mode User Exec and Privileged Exec

Example To display the current configuration of the DHCP server, use the command:

```
awplus# show ip dhcp server summary
```

Output Figure 54-17: Example output from the **show ip dhcp server summary** command

```
DHCP Server service is disabled
BOOTP ignore is disabled
DHCP leasequery support is disabled
Pool list: p2
```

Related commands

- [ip dhcp leasequery enable](#)
- [ip dhcp pool](#)
- [service dhcp-server](#)

subnet-mask

Overview This command sets the subnet mask option for a DHCP address pool you are configuring. Use this command to specify the client's subnet mask as defined in RFC 950. This sets the subnet details using the pre-defined option 1. Note that if you create a user-defined option 1 using the [option](#) command, then you will override any settings created with this command. If you do not specify a subnet mask using this command, then the pool's network mask (specified using the [next-server](#) command) is applied.

The **no** variant of this command removes a subnet mask option from a DHCP pool. The pool reverts to using the pool's network mask.

Syntax `subnet-mask <mask>`
`no subnet-mask`

Parameter	Description
<code><mask></code>	Valid IPv4 subnet mask, in dotted decimal notation.

Mode DHCP Configuration

Examples To set the subnet mask option to 255.255.255.0 for DHCP pool P2, use the commands:

```
awplus# configure terminal
awplus(config)# ip dhcp pool P2
awplus(dhcp-config)# subnet-mask 255.255.255.0
```

To remove the subnet mask option from DHCP pool P2, use the commands:

```
awplus# configure terminal
awplus(config)# ip dhcp pool P2
awplus(dhcp-config)# no subnet-mask
```

Related commands

- [default-router](#)
- [dns-server](#)
- [domain-name](#)
- [next-server](#)
- [option](#)
- [service dhcp-server](#)
- [show ip dhcp pool](#)

vrf

Overview Use this command to add a VRF name to a DHCP server's address pool. This enables the DHCP server to become VRF-aware and allocate IP addresses which are the same as other pools.

One of the benefits of using this command is that it allows you to share DHCP leases across multiple isolated networks.

Use the **no** variant of this command to remove a VRF name from the DHCP server pool.

Syntax `vrf <vrf-name>`
`no vrf`

Parameter	Description
<code><vrf-name></code>	The name of the specific VRF instance.

Default Global VRF

Mode DHCP Configuration

Usage notes You need to enter this **vrf** command before entering the [network \(DHCP\)](#) and [range](#) address commands.

For more information, see the [DHCP Feature Overview and Configuration Guide](#).

Example To add the VRF name 'red' to the DHCP pool named 'P1', use the commands:

```
awplus# configure terminal
awplus(config)# ip dhcp pool P1
awplus(dhcp-config)# vrf red
```

To remove a VRF name from the DHCP pool named 'P1', use the commands:

```
awplus# configure terminal
awplus(config)# ip dhcp pool P1
awplus(dhcp-config)# no vrf
```

Related commands [network \(DHCP\)](#)
[range](#)
[show ip dhcp pool](#)

Command changes Version 5.5.1-1.1: command added

55

DHCP for IPv6 (DHCPv6) Commands

Introduction

Overview This chapter provides an alphabetical reference for commands used to configure DHCPv6. For more information, see the [DHCPv6 Feature Overview and Configuration Guide](#).

DHCPv6 is a network protocol used to configure IPv6 hosts with IPv6 addresses and IPv6 prefixes for an IPv6 network. DHCPv6 is used instead of SLAAC (Stateless Address Autoconfiguration) at sites where centralized management of IPv6 hosts is needed. IPv6 routers require automatic configuration of IPv6 addresses and IPv6 prefixes.

DHCPv6 Prefix Delegation provides automatic configuration of IPv6 addresses and IPv6 prefixes.

Note that DHCPv6 client does not support tunnel interface.

For information on filtering and saving command output, see the [“Getting Started with AlliedWare Plus” Feature Overview and Configuration Guide](#).

NOTE: The IPv6 addresses shown use the address space 2001:0db8::/32, defined in RFC 3849 for documentation purposes. These addresses should not be used for practical networks (other than for testing purposes) nor should they appear on any public network.

- Command List**
- [“address prefix”](#) on page 3134
 - [“address range”](#) on page 3136
 - [“clear counter ipv6 dhcp-client”](#) on page 3138
 - [“clear counter ipv6 dhcp-server”](#) on page 3139
 - [“clear ipv6 dhcp binding”](#) on page 3140
 - [“clear ipv6 dhcp client”](#) on page 3142
 - [“dns-server \(DHCPv6\)”](#) on page 3143
 - [“domain-name \(DHCPv6\)”](#) on page 3145

- [“ip dhcp-relay agent-option”](#) on page 3146
- [“ip dhcp-relay agent-option checking”](#) on page 3148
- [“ip dhcp-relay agent-option remote-id”](#) on page 3149
- [“ip dhcp-relay information policy”](#) on page 3150
- [“ip dhcp-relay maxhops”](#) on page 3152
- [“ip dhcp-relay max-message-length”](#) on page 3153
- [“ip dhcp-relay server-address”](#) on page 3155
- [“ipv6 address \(DHCPv6 PD\)”](#) on page 3157
- [“ipv6 address dhcp”](#) on page 3159
- [“ipv6 dhcp client pd”](#) on page 3161
- [“ipv6 dhcp option”](#) on page 3163
- [“ipv6 dhcp pool”](#) on page 3165
- [“ipv6 dhcp server”](#) on page 3167
- [“ipv6 local pool”](#) on page 3169
- [“ipv6 nd prefix \(DHCPv6\)”](#) on page 3171
- [“link-address”](#) on page 3173
- [“option \(DHCPv6\)”](#) on page 3175
- [“prefix-delegation pool”](#) on page 3177
- [“service dhcp-relay”](#) on page 3179
- [“show counter dhcp-relay”](#) on page 3180
- [“show counter ipv6 dhcp-client”](#) on page 3184
- [“show counter ipv6 dhcp-server”](#) on page 3186
- [“show ip dhcp-relay”](#) on page 3188
- [“show ipv6 dhcp”](#) on page 3190
- [“show ipv6 dhcp binding”](#) on page 3191
- [“show ipv6 dhcp interface”](#) on page 3194
- [“show ipv6 dhcp pool”](#) on page 3196
- [“sntp-address”](#) on page 3198

address prefix

Overview Use this command in DHCPv6 Configuration mode to specify an address prefix for address assignment with DHCPv6 server pool configuration.

Use the **no** variant of this command to remove the address prefix from the DHCPv6 server pool.

Syntax `address prefix <ipv6-prefix/prefix-length> [lifetime {<valid-time>|infinite} {<preferred-time>|infinite}]`
`no address prefix <ipv6-prefix/prefix-length>`

Parameter	Description
<code><ipv6-prefix/prefix-length></code>	Specify an IPv6 prefix and prefix length. The prefix length indicates the length of the IPv6 prefix assigned to the pool. The IPv6 address uses the format X:X::X:X/Prefix-Length. The prefix-length is usually set between 0 and 64.
<code>lifetime</code>	Specify a time period for the hosts to remember router advertisements (RAs). If you specify the optional lifetime parameter with this command then you must also specify a <i>valid-time</i> and a <i>preferred-time</i> value. See the Usage notes below this parameter table for a description of preferred and valid lifetimes and how these determine deprecated or invalid IPv6 addresses upon expiry.
<code><valid-time></code>	Specify a valid lifetime in seconds in the range <5-315360000>. The default valid lifetime is 2592000 seconds.
<code>infinite</code>	Specify an infinite valid lifetime or an infinite preferred lifetime, or both, when using this keyword.
<code><preferred-time></code>	Specify a preferred lifetime in seconds in the range <5-315360000>. The default preferred lifetime is 604800 seconds.

Mode DHCPv6 Configuration

Default The default valid lifetime is 2592000 seconds and the default preferred lifetime is 604800 seconds.

Usage notes This command creates a pool of prefixes from which addresses are assigned to clients on request, and allocates a network prefix from which the DHCPv6 Server leases addresses. This command is an alternative to using a range set using the [address range](#) command.

The DHCPv6 Server selects an IPv6 address from the range available allocated by the IPv6 prefix, randomly generating the suffix of the IPv6 address, with the specified preferred and valid lifetime leases. Leased IPv6 address are found in the

DHCPv6 Server REPLY packet, which is located within the IANA (Identity Association for Non-temporary Addresses) IA address field in the **REPLY** message.

Preferred IPv6 addresses or prefixes are available to interfaces for unrestricted use and are deprecated when the preferred timer expires.

Deprecated IPv6 addresses and prefixes are available for use and are discouraged but not forbidden. A deprecated address or prefix should not be used as a source address or prefix, but packets sent from deprecated addresses or prefixes are delivered as expected.

An IPv6 address or prefix becomes invalid and is not available to an interface when the valid lifetime timer expires. Invalid addresses or prefixes should not appear as the source or destination for a packet.

Examples To add IPv6 address prefix 2001:0db8:1::/48 for DHCPv6 server pool configuration, use the following commands:

```
awplus# configure terminal
awplus(config)# ipv6 dhcp pool pool1
awplus(config-dhcp6)# address prefix 2001:0db8:1::/48
```

To remove a configured IPv6 address prefix for DHCPv6 server pool configuration, use the following commands:

```
awplus# configure terminal
awplus(config)# ipv6 dhcp pool pool1
awplus(config-dhcp6)# no address prefix 2001:0db8:1::/48
```

Related commands [address range](#)
[ipv6 dhcp pool](#)

Validation Commands [show ipv6 dhcp binding](#)
[show ipv6 dhcp pool](#)

address range

Overview Use this command in DHCPv6 Configuration mode to specify an address range for address assignment with DHCPv6 server pool configuration.

Use the **no** variant of this command to remove an address range from the DHCPv6 server pool.

Syntax `address range <first-ipv6-address>
<last-ipv6-address>[lifetime {<valid-time>|infinite}
{<preferred-time>|infinite}]`
`no address range <first-ipv6-address> <last-ipv6-address>`

Parameter	Description
<code><first-ipv6-address></code>	Specify the first IPv6 address of the IPv6 address range, in hexadecimal notation in the format X:X:X:X.
<code><last-ipv6-address></code>	Specify the last IPv6 address of the IPv6 address range, in hexadecimal notation in the format X:X:X:X.
<code>lifetime</code>	Optional. Specify a time period for the hosts to remember router advertisements (RAs). If you specify this parameter then you must also specify a <i>valid-time</i> and a <i>preferred-time</i> value. See the Usage notes below this parameter table for a description of preferred and valid lifetimes and how these determine deprecated or invalid IPv6 addresses upon expiry.
<code><valid-time></code>	Specify a valid lifetime in seconds in the range <5-31536000>. The default valid lifetime is 2592000 seconds.
<code>infinite</code>	Specify an infinite valid lifetime or an infinite preferred lifetime, or both, when using this keyword.
<code><preferred-time></code>	Specify a preferred lifetime in seconds in the range <5-31536000>. The default preferred lifetime is 604800 seconds.

Default The default valid lifetime is 2592000 seconds and the default preferred lifetime is 604800 seconds.

Mode DHCPv6 Configuration

Usage Preferred IPv6 addresses or prefixes are available to interfaces for unrestricted use and are deprecated when the preferred timer expires.

Deprecated IPv6 addresses and prefixes are available for use and are discouraged but not forbidden. A deprecated address or prefix should not be used as a source address or prefix, but packets sent from deprecated addresses or prefixes are delivered as expected.

An IPv6 address or prefix becomes invalid and is not available to an interface when the valid lifetime timer expires. Invalid addresses or prefixes should not appear as the source or destination for a packet.

Examples To add the IPv6 address range 2001:0db8:1::1 to 2001:0db8:1fff::1 for DHCPv6 server pool configuration, use the following commands:

```
awplus# configure terminal
awplus(config)# ipv6 dhcp pool pool1
awplus(config-dhcp6)# address range 2001:0db8:1::1
2001:0db8:1fff::1
```

To remove a configured IPv6 address range for DHCPv6 server pool configuration, use the following commands:

```
awplus# configure terminal
awplus(config)# ipv6 dhcp pool pool1
awplus(config-dhcp6)# no address range
```

Related commands [address prefix](#)
[ipv6 dhcp pool](#)

Validation Commands [show ipv6 dhcp binding](#)
[show ipv6 dhcp pool](#)

clear counter ipv6 dhcp-client

Overview Use this command in Privileged Exec mode to clear DHCPv6 client counters.

Syntax `clear counter ipv6 dhcp-client`

Mode Privileged Exec

Example To clear DHCPv6 client counters, use the following command:

```
awplus# clear counter ipv6 dhcp-client
```

Related commands [show counter ipv6 dhcp-client](#)

clear counter ipv6 dhcp-server

Overview Use this command in Privileged Exec mode to clear DHCPv6 server counters.

Syntax `clear counter ipv6 dhcp-server`

Mode Privileged Exec

Example To clear DHCPv6 server counters, use the following command:

```
awplus# clear counter ipv6 dhcp-server
```

Related commands [show counter ipv6 dhcp-server](#)

clear ipv6 dhcp binding

Overview Use this command in Privileged Exec mode to clear either a specific lease binding or the lease bindings as specified by the command parameters. The command will only take effect on dynamically allocated bindings, not statically configured bindings. This command clears binding entries on the DHCPv6 server binding table.

Syntax `clear ipv6 dhcp binding {ipv6 <prefix>|duid <DUID>|all|pool <name>}`

Parameter	Description
<code>ipv6 <prefix></code>	Optional. Specify the IPv6 prefix of the DHCPv6 client, in hexadecimal notation in the format X:X::X:X.
<code>duid <DUID></code>	Specify the DUID (DHCPv6 unique ID) of the DHCPv6 client.
<code>all</code>	All DHCPv6 bindings.
<code>pool <name></code>	Description used to identify DHCPv6 server address pool. Valid characters are any printable character. If the name contains spaces then you must enclose these in "quotation marks".

Mode Privileged Exec

Usage notes A specific binding may be deleted by **ipv6** address or **duid** address, or several bindings may be deleted at once using **all** or **pool**.

Note that if you specify to clear the **ipv6** or **duid** address of what is actually a static DHCPv6 binding, an error message is displayed. If **all** or **pool** are specified and one or more static DHCPv6 bindings exist within those addresses, any dynamic entries within those addresses are cleared but any static entries are not cleared.

The `clear ipv6 dhcp binding` command is used as a server function. A binding table entry on the DHCPv6 server is automatically:

- Created whenever a prefix is delegated to a client from the configuration pool.
- Updated when the client renews, rebinds, or confirms the prefix delegation.
- Deleted when the client releases all the prefixes in the binding, all prefix lifetimes have expired, or when a user runs the `clear ipv6 dhcp binding` command.

If the **clear ipv6 dhcp binding** command is used with the optional IPv6 address parameter, only the binding for the specified client is deleted. If the **clear ipv6 dhcp binding** command is used without the optional IPv6 address parameter, then all automatic client bindings are deleted from the DHCPv6 bindings table.

Example To clear all dynamic DHCPv6 server binding entries, use the command:

```
awplus# clear ipv6 dhcp binding all
```

Output Figure 55-1: Example output from the **clear ipv6 dhcp binding all** command

```
awplus#clear ipv6 dhcp binding all
% Deleted 1 entries
```

Related commands [show ipv6 dhcp binding](#)

clear ipv6 dhcp client

Overview Use this command in Privileged Exec mode to restart a DHCPv6 client on an interface.

Syntax `clear ipv6 dhcp client <interface>`

Parameter	Description
<code><interface></code>	Specify the interface name to restart a DHCPv6 client on.

Mode Privileged Exec

Example To restart a DHCPv6 client on interface vlan1, use the following command:

```
awplus# clear ipv6 dhcp client vlan1
```

Related commands [show ipv6 dhcp binding](#)

dns-server (DHCPv6)

Overview Use this command to add a Domain Name System (DNS) server to the DHCPv6 address pool you are configuring. You can use this command multiple times to create a list of DNS name servers available to the client. This sets the DNS server details using the pre-defined option 6. Note that if you add a user-defined option 6 using the [option \(DHCPv6\)](#) command, then you will override any settings created with this command.

Use the **no** variant of this command to remove either the specified DNS server or all DNS servers from the DHCPv6 pool.

Syntax `dns-server <ipv6-address>`
`no dns-server [<ipv6-address>]`

Parameter	Description
<code><ipv6-address></code>	Specify an IPv6 address of the DNS server, in hexadecimal notation in the format <code>X:X::X:X</code> . This parameter is required when adding a DNS server to the DHCPv6 address pool. All DNS servers are removed from the DHCPv6 pool if you enter the <code>no dns-server</code> command without this parameter.

Mode DHCPv6 Configuration

Examples To add the DNS server with the assigned IPv6 address `2001:0db8:3000:3000::32` to the DHCPv6 server pool named `P2`, use the following commands:

```
awplus# configure terminal
awplus(config)# ipv6 dhcp pool P2
awplus(dhcpv6-config)# dns-server 2001:0db8:3000:3000::32
```

To remove the DNS server with the assigned IPv6 address `2001:0db8:3000:3000::32` from the DHCPv6 server pool named `P2`, use the following commands:

```
awplus# configure terminal
awplus(config)# ipv6 dhcp pool P2
awplus(dhcpv6-config)# no dns-server 2001:0db8:3000:3000::32
```

To remove all DNS servers from the DHCPv6 server pool named `P2`, use the following commands:

```
awplus# configure terminal
awplus(config)# ipv6 dhcp pool P2
awplus(dhcpv6-config)# no dns-server
```

**Related
commands** `ipv6 dhcp pool`
 `option (DHCPv6)`
 `show ipv6 dhcp pool`

domain-name (DHCPv6)

Overview Use this command in DHCPv6 Configuration mode to add a domain name to the DHCPv6 server address pool you are configuring.

Use the **no** variant of this command to remove a domain name from the address pool.

Syntax `domain-name <domain-name>`
`no domain-name`

Parameter	Description
<code><domain-name></code>	Specify the domain name you wish to assign the DHCPv6 server address pool. Valid characters are printable characters. If the name contains spaces then you must enclose it in "quotation marks".

Mode DHCPv6 Configuration

Usage This command specifies the domain name that a client should use when resolving host names using the Domain Name System, and sets the domain name details using the pre- defined option 15. Note that if you add a user-defined option 15 using the [option \(DHCPv6\)](#) command, then you will override any settings created with this command.

Examples To add the domain name `Engineering` to DHCPv6 server pool `P2`, use the commands:

```
awplus# configure terminal
awplus(config)# ipv6 dhcp pool P2
awplus(dhcpv6-config)# domain-name Engineering
```

To remove the domain name `Engineering` from DHCPv6 server pool `P2`, use the commands:

```
awplus# configure terminal
awplus(config)# ipv6 dhcp pool P2
awplus(dhcpv6-config)# no domain-name Engineering
```

Related commands

- [dns-server \(DHCPv6\)](#)
- [option \(DHCPv6\)](#)
- [show ipv6 dhcp pool](#)

ip dhcp-relay agent-option

Overview This command enables the DHCP Relay Agent to insert the DHCP Relay Agent Information Option (Option 82) into the client-request packets that it relays to its DHCP server. This allows the DHCP Relay Agent to pass on information to the server about the network location of the client device. The DHCP Relay Agent strips the DHCP Relay Agent Option 82 field out of the DHCP server's response, so that the DHCP client never sees this field.

When the DHCP Relay Agent appends its DHCP Relay Agent Option 82 data into the packet, it first overwrites any pad options present; then if necessary, it increases the packet length to accommodate the DHCP Relay Agent Option 82 data.

The **no** variant of this command stops the DHCP Relay Agent from appending the Option 82 field onto DHCP requests before forwarding it to the server.

For DHCP Relay Agent and DHCP Relay Agent Option 82 introductory information, see the [DHCP Feature Overview and Configuration Guide](#).

NOTE: *The DHCP-relay service might alter the content of the DHCP Relay Agent Option 82 field, if the commands `ip dhcp-relay agent-option` and `ip dhcp-relay information policy` have been configured.*

Syntax

```
ip dhcp-relay agent-option  
no ip dhcp-relay agent-option
```

Default DHCP Relay Agent Information Option (Option 82) insertion is disabled by default.

Mode Interface Configuration for VLAN, Eth, WWAN, and bridge interfaces and 802.1Q sub-interfaces.

Usage notes Use this command to alter the DHCP Relay Agent Option 82 setting when your device is the first hop for the DHCP client. To limit the maximum length of the packet, use the [ip dhcp-relay max-message-length](#) command.

Examples To make the relay agent listening on eth1 append the DHCP Relay Agent Option 82 field, use the commands:

```
awplus# configure terminal  
awplus(config)# interface eth1  
awplus(config-if)# ip dhcp-relay agent-option
```

To stop the relay agent from appending the DHCP Relay Agent Option 82 field on eth1, use the commands:

```
awplus# configure terminal  
awplus(config)# interface eth1  
awplus(config-if)# no ip dhcp-relay agent-option
```

Related commands

- ip dhcp-relay agent-option remote-id
- ip dhcp-relay information policy
- ip dhcp-relay max-message-length
- service dhcp-relay

ip dhcp-relay agent-option checking

Overview This command enables the DHCP Relay Agent to check DHCP Relay Agent Information Option (Option 82) information in response packets returned from DHCP servers. If the information does not match the information it has for its own client (downstream) interface then the DHCP Relay Agent drops the packet. Note that [ip dhcp-relay agent-option](#) must be configured.

The DHCP Relay Agent Option 82 field is included in relayed client DHCP packets if:

- DHCP Relay Agent Option 82 is enabled ([ip dhcp-relay agent-option](#)), and
- DHCP Relay Agent is enabled on the device ([service dhcp-relay](#))

For DHCP Relay Agent and DHCP Relay Agent Option 82 introductory information, see the [DHCP Feature Overview and Configuration Guide](#).

Syntax `ip dhcp-relay agent-option checking`
`no ip dhcp-relay agent-option checking`

Mode Interface Configuration for VLAN, Eth, WWAN, and bridge interfaces and 802.1Q sub-interfaces.

Examples To make the relay agent listening on eth1 check the DHCP Relay Agent Information Option (Option 82) field, use the commands:

```
awplus# configure terminal
awplus(config)# interface eth1
awplus(config-if)# ip dhcp-relay agent-option
awplus(config-if)# ip dhcp-relay agent-option checking
```

To stop the relay agent from checking the DHCP Relay Agent Information Option (Option 82) field on eth1, use the commands:

```
awplus# configure terminal
awplus(config)# interface eth1
awplus(config-if)# no ip dhcp-relay agent-option checking
```

Related commands [ip dhcp-relay agent-option](#)
[ip dhcp-relay agent-option remote-id](#)
[ip dhcp-relay information policy](#)
[service dhcp-relay](#)

ip dhcp-relay agent-option remote-id

Overview Use this command to specify the Remote ID sub-option of the DHCP Relay Agent Option 82 field the DHCP Relay Agent inserts into clients' request packets. The Remote ID identifies the device that is inserting the DHCP Relay Agent Option 82 information. If a Remote ID is not specified, the Remote ID sub-option is set to the device's MAC address.

Use the **no** variant of this command to return the Remote ID for an interface.

For DHCP Relay Agent and DHCP Relay Agent Option 82 introductory information, see the [DHCP Feature Overview and Configuration Guide](#).

Syntax `ip dhcp-relay agent-option remote-id <remote-id>`
`no ip dhcp-relay agent-option remote-id`

Parameter	Description
<code><remote-id></code>	An alphanumeric (ASCII) string, 1 to 63 characters in length. Additional characters allowed are hyphen (-), underscore (_) and hash (#). Spaces are not allowed.

Default The Remote ID is set to the device's MAC address by default.

Mode Interface Configuration for VLAN, Eth, WWAN, and bridge interfaces and 802.1Q sub-interfaces.

Usage notes The Remote ID sub-option is included in the DHCP Relay Agent Option 82 field of relayed client DHCP packets if:

- DHCP Relay Agent Option 82 is enabled ([ip dhcp-relay agent-option](#)), and
- DHCP Relay Agent is enabled on the device ([service dhcp-relay](#))

Examples To set the Remote ID to myid for client DHCP packets received on eth1, use the commands:

```
awplus# configure terminal
awplus(config)# interface eth1
awplus(config-if)# ip dhcp-relay agent-option remote-id myid
```

To remove the Remote ID specified for eth1, use the commands:

```
awplus# configure terminal
awplus(config)# interface eth1
awplus(config-if)# no ip dhcp-relay agent-option remote-id
```

Related commands [ip dhcp-relay agent-option](#)
[ip dhcp-relay agent-option checking](#)
[show ip dhcp-relay](#)

ip dhcp-relay information policy

Overview This command sets the policy for how the DHCP relay deals with packets arriving from the client that contain DHCP Relay Agent Option 82 information.

If the command **ip dhcp-relay agent-option** has not been configured, then this command has no effect at all - no alteration is made to Option 82 information in packets arriving from the client side.

However, if the command **ip dhcp-relay agent-option** has been configured, this command modifies how the DHCP relay service deals with cases where the packet arriving from the client side already contains DHCP Relay Agent Option 82 information.

This command sets the action that the DHCP relay should take when a received DHCP client request contains DHCP Relay Agent Option 82 information.

By default, the DHCP Relay Agent replaces any existing DHCP Relay Agent Option 82 field with its own DHCP Relay Agent field. This is equivalent to the functionality of the **replace** parameter.

The **no** variant of this command returns the policy to the default behavior - i.e. replacing the existing DHCP Relay Agent Option 82 field.

For DHCP Relay Agent and DHCP Relay Agent Option 82 introductory information, see the [DHCP Feature Overview and Configuration Guide](#).

NOTE: The DHCP-relay service might alter the content of the DHCP Relay Agent Option 82 field, if the commands [ip dhcp-relay agent-option](#) and [ip dhcp-relay information policy](#) have been configured.

Syntax

```
ip dhcp-relay information policy {append|drop|keep|replace}
no ip dhcp-relay information policy
```

Parameter	Description
append	The DHCP Relay Agent appends the DHCP Relay Agent Option 82 field of the packet with its own DHCP Relay Agent Option 82 details.
drop	The DHCP Relay Agent discards the packet.
keep	The DHCP Relay Agent forwards the packet without altering the DHCP Relay Agent Option 82 field.
replace	The DHCP Relay Agent replaces the existing DHCP Relay Agent details in the DHCP Relay Agent Option 82 field with its own details before forwarding the packet.

Mode Interface Configuration for VLAN, Eth, WWAN, and bridge interfaces and 802.1Q sub-interfaces.

Examples To make the DHCP Relay Agent listening on eth1 drop any client requests that already contain DHCP Relay Agent Option 82 information, use the commands:

```
awplus# configure terminal
awplus(config)# interface eth1
awplus(config-if)# ip dhcp-relay information policy drop
```

To reset the DHCP relay information policy to the default policy for interface eth1, use the commands:

```
awplus# configure terminal
awplus(config)# interface eth1
awplus(config-if)# no ip dhcp-relay information policy
```

Related commands

- [ip dhcp-relay agent-option](#)
- [ip dhcp-relay agent-option checking](#)
- [service dhcp-server](#)

ip dhcp-relay maxhops

Overview This command sets the hop count threshold for discarding BOOTP messages. When the hops field in a BOOTP message exceeds the threshold, the DHCP Relay Agent discards the BOOTP message. The hop count threshold is set to 10 hops by default.

Use the **no** variant of this command to reset the hop count to the default.

For DHCP Relay Agent and DHCP Relay Agent Option 82 introductory information, see the [DHCP Feature Overview and Configuration Guide](#).

Syntax `ip dhcp-relay maxhops <1-255>`
`no ip dhcp-relay maxhops`

Parameter	Description
<1-255>	The maximum hop count value.

Default The default hop count threshold is 10 hops.

Mode Interface Configuration for VLAN, Eth, WWAN, and bridge interfaces and 802.1Q sub-interfaces.

Example To set the maximum number of hops to 5 for packets received on interface eth1, use the commands:

```
awplus# configure terminal
awplus(config)# interface eth1
awplus(config-if)# ip dhcp-relay maxhops 5
```

Related commands [service dhcp-relay](#)

ip dhcp-relay max-message-length

Overview This command applies when the device is acting as a DHCP Relay Agent and DHCP Relay Agent Option 82 insertion is enabled. It sets the maximum DHCP message length (in bytes) for the DHCP packet with its DHCP Relay Agent Option 82 data inserted. From this value it calculates the maximum packet size that it will accept at its input. Packets that arrive greater than this value will be dropped.

The **no** variant of this command sets the maximum message length to its default of 1400 bytes.

For DHCP Relay Agent and DHCP Relay Agent Option 82 introductory information, see the [DHCP Feature Overview and Configuration Guide](#).

Syntax `ip dhcp-relay max-message-length <548-1472>`
`no ip dhcp-relay max-message-length`

Parameter	Description
<548-1472>	The maximum DHCP message length (this is the message header plus the inserted DHCP option fields in bytes).

Default The default is 1400 bytes.

Mode Interface Configuration for VLAN, Eth, WWAN, and bridge interfaces and 802.1Q sub-interfaces.

Usage notes When a DHCP Relay Agent (that has DHCP Relay Agent Option 82 insertion enabled) receives a request packet from a DHCP client, it will append the DHCP Relay Agent Option 82 component data, and forward the packet to the DHCP server. The DHCP client will sometimes issue packets containing pad option fields that can be overwritten with Option 82 data.

Where there are insufficient pad option fields to contain all the DHCP Relay Agent Option 82 data, the DHCP Relay Agent will increase the packet size to accommodate the DHCP Relay Agent Option 82 data. If the new (increased) packet size exceeds that defined by the **maximum-message-length** parameter, then the DHCP Relay Agent will drop the packet.

NOTE: Before setting this command, you must first run the `ip dhcp-relay agent-option` command. This will allow the DHCP Relay Agent Option 82 fields to be appended.

Example To set the maximum DHCP message length to 1200 bytes for packets arriving in interface eth1, use the commands:

```
awplus# configure terminal
awplus(config)# interface eth1
awplus(config-if)# ip dhcp-relay max-message-length 1200
```

To reset the maximum DHCP message length to the default of 1400 bytes for packets arriving in interface eth1, use the commands:

```
awplus# configure terminal
awplus(config)# interface eth1
awplus(config-if)# no ip dhcp-relay max-message-length
```

Related commands [service dhcp-relay](#)

ip dhcp-relay server-address

Overview This command adds a DHCP server for the DHCP Relay Agent to forward client DHCP packets to on a particular interface. You can add up to five DHCP servers on each device interface that the DHCP Relay Agent is listening on.

The **no** variant of this command deletes the specified DHCP server from the list of servers available to the DHCP relay agent.

The **no ip dhcp-relay** command removes all DHCP relay settings from the interface.

For DHCP Relay Agent and DHCP Relay Agent Option 82 introductory information, see the [DHCP Feature Overview and Configuration Guide](#).

Syntax

```
ip dhcp-relay server-address {<ipv4-address>|<ipv6-address>
<server-interface>}

no ip dhcp-relay server-address {<ipv4-address>|<ipv6-address>
<server-interface>}

no ip dhcp-relay
```

Parameter	Description
<ipv4-address>	Specify the IPv4 address of the DHCP server for the DHCP Relay Agent to forward client DHCP packets to, in dotted decimal notation. The IPv4 address uses the format A.B.C.D.
<ipv6-address>	Specify the IPv6 address of the DHCPv6 server for the DHCPv6 Relay Agent to forward client DHCP packets to, in hexadecimal notation.
<server-interface>	Specify the interface name of the DHCPv6 server. It is only required for a DHCPv6 server with an IPv6 address.

Mode Interface Configuration for VLAN, Eth, WWAN, and bridge interfaces and 802.1Q sub-interfaces.

Usage notes For a DHCP server with an IPv6 address you must specify the interface for the DHCP server. See examples below for configuration differences between IPv4 and IPv6 DHCP relay servers.

See also the [service dhcp-relay](#) command to enable the DHCP Relay Agent on your device. The [ip dhcp-relay server-address](#) command defines a relay destination on an interface on the device, needed by the DHCP Relay Agent to relay DHCP client packets to a DHCP server.

Examples: DHCP for IPv4 To enable the DHCP Relay Agent to relay DHCP packets on interface eth1 to the DHCP server with the IPv4 address 192.0.2.200, use the commands:

```
awplus# configure terminal
awplus(config)# service dhcp-relay
awplus(config)# interface eth1
awplus(config-if)# ip dhcp-relay server-address 192.0.2.200
```

To remove the DHCP server with the IPv4 address 192.0.2.200 from the list of servers available to the DHCP Relay Agent on interface eth1, use the commands:

```
awplus# configure terminal
awplus(config)# interface eth1
awplus(config-if)# no ip dhcp-relay server-address 192.0.2.200
```

Examples: DHCPv6 To enable the DHCP Relay Agent on your device to relay DHCP packets on interface eth1.2 to the DHCP server with the IPv6 address 2001:0db8:010d::1 on interface eth1.4, use the commands:

```
awplus# configure terminal
awplus(config)# service dhcp-relay
awplus(config)# interface eth1.2
awplus(config-if)# ip dhcp-relay server-address
2001:0db8:010d::1 eth1.4
```

To remove the DHCP server with the IPv6 address 2001:0db8:010d::1 on interface eth1.4 from the list of servers available to the DHCP Relay Agent on interface eth1.2, use the commands:

```
awplus# configure terminal
awplus(config)# interface eth1.2
awplus(config-if)# no ip dhcp-relay server-address
2001:0db8:010d::1 eth1.4
```

Example: disabling DHCP relay To disable DHCP relay on eth1, use the commands:

```
awplus# configure terminal
awplus(config)# interface eth1
awplus(config-if)# no ip dhcp-relay
```

Related commands [service dhcp-relay](#)

ipv6 address (DHCPV6 PD)

Overview Use this command to append an IPv6 address suffix to the IPv6 prefix provided by a DHCPV6 Prefix Delegation (PD) server.

Use the **no** variant of this command to remove the IPv6 address assigned and disable IPv6. Note that if no global addresses are left after removing the IPv6 address then IPv6 is disabled.

Syntax `ipv6 address [<ipv6-prefix-name>] <ipv6-addr/prefix-length> [eui64]`
`no ipv6 address [<ipv6-prefix-name>] <ipv6-addr/prefix-length> [eui64]`

Parameter	Description
<code><ipv6-prefix-name></code>	The IPv6 prefix name advertised on the router advertisement message sent from the device. The IPv6 prefix name is delegated from the DHCPV6 Server configured for DHCPV6 Prefix-Delegation.
<code><ipv6-addr/prefix-length></code>	Specifies the IPv6 address to be set, for example ::1/64. The IPv6 address uses the format X:X::X:X/Prefix-Length. The prefix-length is usually set between 0 and 64.
<code>eui64</code>	EUI-64 is a method of automatically deriving the lower 64 bits of an IPv6 address, based on the switch's MAC address.

Mode Interface Configuration for VLAN, Eth, WWAN, and bridge interfaces and 802.1Q sub-interfaces.

Usage notes When specifying the **eui64** parameter, the interface identifier of the IPv6 address is derived from the MAC address of the device.

For more information about EUI64, see the [IPv6 Feature Overview and Configuration Guide](#).

Examples To assign the IPv6 address 2001:0db8::a2/48 to the VLAN interface vlan2, use the following commands:

```
awplus# configure terminal
awplus(config)# interface vlan2
awplus(config-if)# ipv6 address 2001:0db8::a2/48
```

To remove the IPv6 address 2001:0db8::a2/48 from the VLAN interface vlan2, use the following commands:

```
awplus# configure terminal
awplus(config)# interface vlan2
awplus(config-if)# no ipv6 address 2001:0db8::a2/48
```

To assign the **eui64** derived address in the prefix 2001:0db8::/64 to VLAN interface vlan2, use the following commands:

```
awplus# configure terminal
awplus(config)# interface vlan2
awplus(config-if)# ipv6 address 2001:0db8::/64 eui64
```

To remove the **eui64** derived address in the prefix 2001:0db8::/64 from VLAN interface vlan2, use the following commands:

```
awplus# configure terminal
awplus(config)# interface vlan2
awplus(config-if)# no ipv6 address 2001:0db8::/64 eui64
```

To configure a PD prefix named 'prefix1' on interface vlan2 and then add an IPv6 address, use the following commands. In this example, the prefix will be assigned from the pool on the PD client. The host portion or suffix will be ::1 for the last 64 bits:

```
awplus# configure terminal
awplus(config)# interface vlan2
awplus(config-if)# ipv6 enable
awplus(config-if)# ipv6 dhcp client pd prefix1
awplus(config-if)# ipv6 address prefix1::1/64
```

**Related
commands**

- [ipv6 dhcp client pd](#)
- [ipv6 dhcp pool](#)
- [ipv6 local pool](#)
- [ipv6 nd prefix \(DHCPv6\)](#)
- [prefix-delegation pool](#)
- [show ipv6 dhcp binding](#)
- [show ipv6 interface](#)
- [show ipv6 route](#)
- [show running-config](#)

ipv6 address dhcp

Overview Use this command to activate the DHCPv6 client on the interface that you are configuring. This allows the interface to use the DHCPv6 client to obtain its IPv6 configuration details from a DHCPv6 server on its connected network.

The command also enables IPv6 on the interface, which creates an EUI-64 link-local address as well as enabling RA processing and SLAAC.

Use the **no** variant of this command to stop the interface from obtaining IPv6 configuration details from a DHCPv6 server.

The DHCPv6 client supports the following IP configuration options:

- Option 1—the subnet mask for your device.
- Option 3—a list of default routers.
- Option 6—a list of DNS servers. This list appends the DNS servers set on your device with the [dns-server \(DHCPv6\)](#) command.
- Option 15—a domain name used to resolve host names. This option replaces any domain name that you have set with the [domain-name \(DHCPv6\)](#) command.
- Option 51—lease expiration time.

Syntax `ipv6 address dhcp [default-route-to-server]`
`no ipv6 address dhcp`

Parameter	Description
<code>default-route-to-server</code>	Allow the automatic configuration of a default route to the DHCPv6 server. This option is not enabled by default when you enable the DHCP client on an interface.

Mode Interface Configuration for VLAN, Eth, WWAN, and bridge interfaces and 802.1Q sub-interfaces.

Usage notes Use the **default-route-to-server** option to allow the automatic configuration of a default route to the DHCPv6 server. Note that this option is not enabled by default when you enable the DHCP client on an interface.

Examples To set the interface `vlan2` to use DHCPv6 to obtain an IPv6 address, use the commands:

```
awplus# configure terminal
awplus(config)# interface vlan2
awplus(config-if)# ipv6 enable
awplus(config-if)# ipv6 address dhcp
```

To stop the interface vlan2 from using DHCPv6 to obtain its IPv6 address, use the commands:

```
awplus# configure terminal
awplus(config)# interface vlan2
awplus(config-if)# no ipv6 address dhcp
```

**Related
commands**

[clear ipv6 dhcp client](#)
[ipv6 address](#)
[ipv6 address \(DHCPv6 PD\)](#)
[show ipv6 dhcp interface](#)
[show running-config](#)

ipv6 dhcp client pd

Overview Use this command in Interface Configuration mode to enable the DHCPv6 client process and enable requests for prefix delegation through the interface that you are configuring.

Use the **no** variant of this command to disable requests for prefix delegation. This is the default setting.

For further information about DHCPv6 Prefix Delegation, which is used to automate the process of assigning prefixes, see the [DHCPv6 Feature Overview and Configuration Guide](#).

Syntax `ipv6 dhcp client pd <prefix-name> <default-route-to-server>`
`no ipv6 dhcp client pd`

Parameter	Description
<code><prefix-name></code>	Specify an IPv6 general prefix name. Valid characters are any printable character. If the name contains spaces then you must enclose it in "quotation marks".
<code><default-route-to-server></code>	Specify the default route to the DHCP server

Mode Interface Configuration for VLAN, Eth, WWAN, and bridge interfaces and 802.1Q sub-interfaces.

Default Prefix delegation is disabled by default on an interface.

Usage notes Entering the **ipv6 dhcp client pd** command starts the DHCPv6 client process if not already running, and enables requests for prefix delegation through the interface on which the command is configured.

When prefix delegation is enabled and a prefix is acquired, the prefix is stored in the IPv6 prefix pool with an internal name defined by the required `<prefix-name>` placeholder parameter. The [ipv6 address](#) command can then refer to the prefixes stored in the IPv6 prefix pool.

Examples To enable prefix delegation with the prefix name my-prefix-name on the interface eth1, use the following commands:

```
awplus# configure terminal
awplus(config)# interface eth1
awplus(config-if)# ipv6 enable
awplus(config-if)# ipv6 dhcp client pd my-prefix-name
```

To disable prefix delegation on the interface eth1, use the following commands:

```
awplus# configure terminal
awplus(config)# interface eth1
awplus(config-if)# no ipv6 dhcp client pd
```

**Related
commands**

- ipv6 enable
- clear ipv6 dhcp client
- ipv6 address (DHCPv6 PD)
- ipv6 nd prefix (DHCPv6)
- show ipv6 dhcp binding
- show ipv6 dhcp interface

ipv6 dhcp option

Overview Use this command in Global Configuration mode to create a user-defined DHCPv6 option. You can then use this option when configuring a DHCPv6 server address pool, by using the [option \(DHCPv6\)](#) command.

Options with the same number as one of the pre-defined options override the standard option definition. The pre-defined options use the option numbers 1, 3, 6, 15, and 51.

Use the **no** variant of this command to remove either the specified user-defined option. This also removes user-defined options from the associated DHCPv6 server address pools.

Syntax `ipv6 dhcp option <1-254> [name <option-name>] [<option-type>]`
`no ipv6 dhcp option <1-254>|<option-name>`

Parameter	Description										
<1-254>	The option number of the option. Options with the same number as one of the standard options overrides the standard option definition.										
<option-name>	Option name used to identify the option. You cannot use a number as the option name. Valid characters are any printable character. If the name contains spaces then you must enclose it in "quotation marks". Default: no default										
<option-type>	The option value. You must specify a value that is appropriate to the option type: <table border="1"><tbody><tr><td>ascii</td><td>An ASCII text string</td></tr><tr><td>hex</td><td>A hexadecimal string. Valid characters are the numbers 0–9 and letters a–f. Embedded spaces are not valid. The string must be an even number of characters, from 2 and 256 characters long.</td></tr><tr><td>ipv6</td><td>An IPv6 address or prefix that has hexadecimal notation in the format <code>HHHH : HHHH : : HHHH : HHHH</code>. To create a list of IPv6 addresses, you must add each IPv6 address individually by using the option command multiple times.</td></tr><tr><td>integer</td><td>A number from 0 to 4294967295.</td></tr><tr><td>flag</td><td>A value that either sets (to 1) or unsets (to 0) a flag: true, on, or enabled will set the flag. false, off or disabled will unset the flag.</td></tr></tbody></table>	ascii	An ASCII text string	hex	A hexadecimal string. Valid characters are the numbers 0–9 and letters a–f. Embedded spaces are not valid. The string must be an even number of characters, from 2 and 256 characters long.	ipv6	An IPv6 address or prefix that has hexadecimal notation in the format <code>HHHH : HHHH : : HHHH : HHHH</code> . To create a list of IPv6 addresses, you must add each IPv6 address individually by using the option command multiple times.	integer	A number from 0 to 4294967295.	flag	A value that either sets (to 1) or unsets (to 0) a flag: true , on , or enabled will set the flag. false , off or disabled will unset the flag.
ascii	An ASCII text string										
hex	A hexadecimal string. Valid characters are the numbers 0–9 and letters a–f. Embedded spaces are not valid. The string must be an even number of characters, from 2 and 256 characters long.										
ipv6	An IPv6 address or prefix that has hexadecimal notation in the format <code>HHHH : HHHH : : HHHH : HHHH</code> . To create a list of IPv6 addresses, you must add each IPv6 address individually by using the option command multiple times.										
integer	A number from 0 to 4294967295.										
flag	A value that either sets (to 1) or unsets (to 0) a flag: true , on , or enabled will set the flag. false , off or disabled will unset the flag.										

Mode Global Configuration

Examples To define a user-defined ASCII string option as option 66, without a name, use the following commands:

```
awplus# configure terminal
awplus(config)# ipv6 dhcp option 66 ascii
```

To define a user-defined hexadecimal string option as option 46, with the name "tcpip-node-type", use the following commands:

```
awplus# configure terminal
awplus(config)# ipv6 dhcp option 46 name tcpip-node-type hex
```

To define a user-defined IP address option as option 175, with the name special-address, use the following commands:

```
awplus# configure terminal
awplus(config)# ipv6 dhcp option 175 name special-address ip
```

To remove the specific user-defined option with the option number 12, use the following commands:

```
awplus# configure terminal
awplus(config)# no ipv6 dhcp option 12
```

To remove the specific user-defined option with the option name perform-router-discovery, use the following commands:

```
awplus# configure terminal
awplus(config)# no ipv6 dhcp option perform-router-discovery
```

Related commands

[dns-server \(DHCPv6\)](#)
[domain-name \(DHCPv6\)](#)
[option \(DHCPv6\)](#)
[show ipv6 dhcp](#)

ipv6 dhcp pool

Overview Use this command in Global Configuration mode to enter the DHCPv6 Configuration mode for the DHCPv6 server pool name as specified in the required command parameter. If the name specified is not associated with an existing pool, the device will create a new pool with this name, then enter the configuration mode for the new pool.

Once you have entered the DHCPv6 configuration mode, all commands executed before the next **exit** command will apply to this pool.

You can create multiple DHCPv6 server pools on devices with multiple interfaces. This allows the device to act as a DHCPv6 server on multiple interfaces to distribute different information to clients on the different networks.

Use the **no** variant of this command to delete the specific DHCPv6 pool.

Syntax `ipv6 dhcp pool <DHCPv6-poolname>`
`no ipv6 dhcp pool <DHCPv6-poolname>`

Parameter	Description
<code><DHCPv6-poolname></code>	Description used to identify this DHCPv6 server pool. Valid characters are any printable character. If the name contains spaces then you must enclose it in "quotation marks".

Mode Global Configuration

Usage All DHCPv6 prefix pool names must be unique. IPv6 prefix pools have a similar function to IPv4 address pools. Contrary to IPv4, a block of IPv6 addresses (an IPv6 address prefix) are assigned and not single IPv6 addresses. IPv6 prefix pools are not allowed to overlap.

Once a pool is configured, it cannot be changed. To change the configuration, you must remove then recreate a IPv6 prefix pool. All IPv6 prefixes already allocated are also freed.

Examples To create the DHCPv6 pool named P2 and enter DHCPv6 configuration mode, use the following commands:

```
awplus# configure terminal
awplus(config)# ipv6 dhcp pool P2
awplus(config-dhcp6)#
```

To delete the DHCPv6 pool named P2, use the following commands:

```
awplus# configure terminal
awplus(config)# no ipv6 dhcp pool P2
```

Related commands

- ipv6 local pool
- option (DHCPv6)
- prefix-delegation pool
- show ipv6 dhcp binding
- show ipv6 dhcp pool

ipv6 dhcp server

Overview Use this command in Interface Configuration mode to enable DHCPv6 server for the current IPv6 configured interface to use the specified DHCPv6 server pool name.

The DHCPv6 server service listens for DHCPv6 requests on the IPv6 configured interface. The DHCPv6 server service does not run on interfaces without IPv6 configured on them.

Use the **no** variant of this command to disable the DHCPv6 server.

Syntax `ipv6 dhcp-server [<DHCPv6-poolname>]`
`no ipv6 dhcp-server`

Parameter	Description
<DHCPv6-poolname>	Specify a named DHCPv6 server pool as defined with the <code>ipv6 dhcp pool</code> command. Valid characters are any printable character. If the name contains spaces then you must enclose it in "quotation marks".

Mode Interface Configuration for VLAN, Eth, and bridge interfaces and 802.1Q sub-interfaces.

Usage notes The **ipv6 dhcp server** command enables the DHCPv6 service on a specified interface using the pool for prefix delegation and configuration through the specified interface.

Note that DHCPv6 client, DHCPv6 server and DHCPv6 relay are mutually exclusive on an interface. When one of the DHCPv6 functions is enabled on an interface then another DHCPv6 function cannot be enabled on the same interface.

Examples To enable the DHCPv6 server service and use the DHCPv6 pool named P2 on VLAN interface `vlan2`, use the following commands:

```
awplus# configure terminal
awplus(config)# interface vlan2
awplus(config-if)# ipv6 dhcp server P2
```

To disable the DHCPv6 server on VLAN interface `vlan2`, use the following commands:

```
awplus# configure terminal
awplus(config)# interface vlan2
awplus(config-if)# no ipv6 dhcp server
```

Related commands `ipv6 dhcp pool`
 `show ipv6 dhcp binding`
 `show ipv6 dhcp pool`

ipv6 local pool

Overview Use this command in Global Configuration mode to configure a local DHCPv6 server prefix delegation pool specifying a poolname and a prefix/prefix length. You can optionally exclude the locally assigned prefix from the pool with the **exclude-local-prefix** keyword.

Use the **no** variant of this command to remove a local DHCPv6 server prefix delegation pool specifying the poolname.

Syntax `ipv6 local pool <DHCPv6-poolname> <delegated-prefix-name>
<ipv6-prefix/prefix-length> <assigned-length>
[exclude-local-prefix]`
`no ipv6 local pool`

Parameter	Description
<code><DHCPv6-poolname></code>	Description used to identify this DHCPv6 server pool. Valid characters are any printable character. If the name contains spaces then you must enclose it in "quotation marks".
<code><delegated-prefix-name></code>	Description used to identify the delegated prefix name from the parent PD (Prefix Delegation) server. If the name contains spaces then you must enclose it in "quotation marks".
<code><ipv6-prefix/prefix-length></code>	Specify an IPv6 prefix and prefix length. The prefix length indicates the length of the IPv6 prefix assigned to the pool. The IPv6 address uses the format X:X::X:X/Prefix-Length. The prefix-length is usually set between 0 and 64.
<code><assigned-length></code>	Specify an IPv6 prefix length assigned to the user from the pool in the range <1-128>. Note that the value of the <i>assigned-length</i> parameter entered cannot be less than or equal to the <i>prefix-length</i> parameter value entered. An assigned length must be longer than a prefix length.
<code>exclude-local-prefix</code>	Specify this keyword to exclude the locally assigned prefix from the pool.

Default No DHCPv6 server prefix delegation pool is configured by default.

Mode Global Configuration

Usage notes All IPv6 prefix pool names must be unique. IPv6 prefix pools have a similar function to IPv4 address pools. Contrary to IPv4, a block of IPv6 addresses (an IPv6 address prefix) are assigned and not single IPv6 addresses. IPv6 prefix pools are not allowed to overlap.

Once a pool is configured, it cannot be changed. To change the configuration, you must remove then recreate a IPv6 prefix pool. All IPv6 prefixes already allocated are also freed.

Examples To create a local DHCPv6 local pool named P2 with the IPv6 prefix and prefix length 2001:0db8::/32 with an assigned length of 64, use the following commands:

```
awplus# configure terminal
awplus(config)# ipv6 local pool P2 2001:0db8::/32 64
```

To remove a configured DHCPv6 local pool, use the following commands:

```
awplus# configure terminal
awplus(config)# no ipv6 local pool
```

Related commands [ipv6 dhcp pool](#)
[show ipv6 dhcp pool](#)

ipv6 nd prefix (DHCPv6)

Overview Use this command to specify IPv6 RA (Router Advertisement) prefix information generated from the DHCPv6 server for DHCPv6 prefix-delegation for an interface.

Use the **no** variant of this command to remove IPv6 RA prefix information from the DHCPv6 Server for DHCPv6 Prefix-Delegation for the interface. Use the **all** parameter with the **no** variant of this command to remove all prefix names and all prefixes for an interface.

Syntax

```
ipv6 nd prefix <ipv6-prefix-name>  
<ipv6-prefix/length>{<valid-lifetime>|infinite}  
{<preferred-lifetime>|infinite} {off-link|no-autoconfig}  
no ipv6 nd prefix {<ipv6-prefix-name>|<ipv6-prefix/length>|all}
```

Parameter	Description
<i><ipv6-prefix-name></i>	The IPv6 prefix name advertised on the router advertisement message sent from the device. The IPv6 prefix name is delegated from the DHCPv6 Server configured for DHCPv6 Prefix-Delegation.
<i><ipv6-prefix/length></i>	The IPv6 prefix and prefix length advertised on the router advertisement message sent from the device. The IPv6 address prefix uses the format X:X::/prefix-length. The prefix-length is usually set between 0 and 64.
<i><valid-lifetime></i>	The the period during which the specified IPv6 address prefix is valid. This can be set to a value between 5 and 315360000 seconds. Note that this period should be set to a value greater than that set for the prefix preferred-lifetime. See the Usage notes after this parameter table for a description of valid lifetime and how it determines invalid IPv6 addresses upon expiry.
infinite	Specifying this keyword instead of entering a value for the <i><valid-lifetime></i> parameter applies an infinite valid lifetime.
<i><preferred-lifetime></i>	Specifies the IPv6 prefix preferred lifetime. This is the period during which the IPv6 address prefix is considered current. Set this to a value between 0 and 315360000 seconds. Note that this period should be set to a value less than that set for the prefix valid-lifetime. See the Usage notes after this parameter table for a description of preferred lifetime and how it determines deprecated IPv6 addresses upon expiry.
infinite	Specifying this keyword instead of entering a value for the <i><preferred-lifetime></i> parameter applies an infinite valid lifetime.
off-link	Specify the IPv6 prefix off-link flag.
no-autoconfig	Specify the IPv6 prefix no autoconfiguration flag. Setting this flag indicates that the prefix is not to be used for autoconfiguration.
all	Specify all prefix names and all prefixes are removed when used with the no variant of this command.

Mode Interface Configuration for VLAN, Eth, WWAN, and bridge interfaces and 802.1Q sub-interfaces.

Usage notes This command specifies the IPv6 prefix flags that are advertised by the router advertisement message.

Preferred IPv6 addresses or prefixes are available to interfaces for unrestricted use and are deprecated when the preferred timer expires.

Deprecated IPv6 addresses and prefixes are available for use and are discouraged but not forbidden. A deprecated address or prefix should not be used as a source address or prefix, but packets sent from deprecated addresses or prefixes are delivered as expected.

An IPv6 address or prefix becomes invalid and is not available to an interface when the valid lifetime timer expires. Invalid addresses or prefixes should not appear as the source or destination for a packet.

Examples The following example configures the device to issue RAs (Router Advertisements) on the interface eth1, and advertises the DHCPv6 prefix name prefix1 and the IPv6 address prefix of 2001:0db8::/32.

```
awplus# configure terminal
awplus(config)# interface eth1
awplus(config-if)# ipv6 enable
awplus(config-if)# ipv6 dhcp client pd prefix1
awplus(config-if)# ipv6 nd prefix prefix1 2001:0db8::/32
```

The following example resets router advertisements on the interface eth1, so the address prefix of 2001:0db8::/32 is not advertised from the device.

```
awplus# configure terminal
awplus(config)# interface eth1
awplus(config-if)# no ipv6 nd prefix 2001:0db8::/32
```

The following example removes all prefix names and prefixes from interface eth1:

```
awplus# configure terminal
awplus(config)# interface eth1
awplus(config-if)# no ipv6 nd prefix all
```

Related commands

- [ipv6 address \(DHCPv6 PD\)](#)
- [ipv6 dhcp client pd](#)
- [ipv6 dhcp pool](#)
- [ipv6 local pool](#)
- [prefix-delegation pool](#)
- [show ipv6 dhcp binding](#)

link-address

Overview Use this command in DHCPv6 Configuration mode to specify a link-address prefix within a DHCPv6 Server pool.

Note that you can only configure one link address per DHCPv6 pool. Configuring another link address in the same DHCPv6 pool overwrites the previously configured link address.

Use the **no** variant of this command to remove the link-address prefix from the DHCPv6 Server pool.

Syntax `link-address <ipv6-prefix/prefix-length>`
`no link-address`

Parameter	Description
<code><ipv6-prefix/prefix-length></code>	Specify an IPv6 prefix and prefix length. The prefix length indicates the length of the IPv6 prefix assigned to the pool. The IPv6 address uses the format X:X::X/Prefix-Length. The prefix-length is usually set between 0 and 64.

Default No DHCPv6 Server pool configuration link address prefix is configured by default.

Mode DHCPv6 Configuration

Usage notes Link addresses are configured in DHCPv6 Server address pools when there are remote clients that communicate via intermediate relay(s).

RELAY-FORW and RELAY-REPL relay packets contain the requesting link address source.

This command is used to match incoming requests from PD (Prefix Delegation) clients (received via an intermediate relay) to a configured delegation pool.

When an address on the incoming interface of the DHCPv6 server or a link address set in the incoming delegation request packet from the prefix delegation client matches the link-address prefix configured in the delegation pool, the DHCPv6 server is able to match and use the appropriate delegation pool for relayed delegation request messages.

If there is no match between incoming delegation request packets from the prefix delegation client and the link-address prefix configured in the delegation pool, the DHCPv6 Server does not delegate an IPv6 prefix to the requesting device.

The link address should be set to the network prefix where the prefix delegation client resides. The prefix delegation server will also need a forwarding path (IPv6 route) back to the network prefix where the prefix delegation client resides.

For more information, see the [DHCPv6 Feature Overview and Configuration Guide](#).

Examples To configure the IPv6 prefix and prefix length 2001:0db8:1::/48 as the link address for pool P2, use the following commands:

```
awplus# configure terminal
awplus(config)# ipv6 dhcp pool P2
awplus(config-dhcp6)# address prefix 2001:0db8:2::/48
awplus(config-dhcp6)# link-address 2001:0db8:1::/48
```

To remove the link address, use the commands:

```
awplus# configure terminal
awplus(config)# ipv6 dhcp pool P2
awplus(config-dhcp6)# no link-address
```

Related commands [ipv6 dhcp pool](#)
[show ipv6 dhcp pool](#)

option (DHCPv6)

Overview Use this command in DHCPv6 Configuration mode to add a user-defined option to the DHCPv6 prefix pool you are configuring. For the **hex**, **integer**, and **flag** option types, if the option already exists, the new option overwrites the existing option's value.

Use the **no** variant of this command to remove the specified user-defined option from the DHCPv6 server pool, or to remove all user-defined options from the DHCPv6 server pool.

Syntax `option [<1-254>|<option-name>] <option-value>`
`no option [<1-254>|<option-value>]`

Parameter	Description	
<1-254>	The option number of the option. Options with the same number as one of the standard options overrides the standard option definition.	
<option-name>	Option name associated with the option.	
<option-value>	The option value. You must specify a value that is appropriate to the option type:	
	hex	A hexadecimal string. Valid characters are the numbers 0–9 and letters a–f. Embedded spaces are not valid. The string must be an even number of characters, from 2 and 256 characters long.
	ipv6	An IPv6 prefix that has the hexadecimal X:X::X:X notation. To create a list of IPv6 prefixes, you must add each IPv6 prefix individually using this command multiple times.
	integer	A number from 0 to 4294967295.
	flag	A value of either true, on, or enabled to set the flag, or false, off or disabled to unset the flag.

Mode DHCPv6 Configuration

Usage You must define a DHCPv6 option using the `ipv6 dhcp option` command before using the `option (DHCPv6)` command.

Note that options with an **ipv6** type can hold a list of IPv6 prefix (i.e. entries that have the X:X::X:X address format), so if the option already exists in the pool, then the new IP address is added to the list of existing IPv6 prefixes. Also note options with the same number as one of the pre-defined options override the standard option definition. The pre-defined options use the option numbers 1, 3, 6, 15, and 51.

Examples To add the IPv6 type option named `sntp-server-addr` to the pool P2 and give the option the value `ipv6`, use the following commands:

```
awplus# configure terminal
awplus(config)# ipv6 dhcp option 22 name sntp_server_addr ipv6
awplus(config)# ipv6 dhcp pool P2
awplus(config-dhcp6)# option sntp_server_addr ipv6
```

To add the ASCII-type option named `tftp-server-name` to the pool P2 and give the option the value `server1`, use the following commands:

```
awplus# configure terminal
awplus(config)# ipv6 dhcp pool P2
awplus(config-dhcp6)# option tftp-server-name server1
```

To add the hex-type option named `tcpip-node-type` to the pool P2 and give the option the value `08af`, use the following commands:

```
awplus# configure terminal
awplus(config)# ipv6 dhcp pool P2
awplus(config-dhcp6)# option tcpip-node-type 08af
```

To add multiple IP addresses for the ip-type option 175, use the following commands:

```
awplus(config-dhcp6)# option 175 2001:0db8:3001::/64
awplus(config-dhcp6)# option 175 2001:0db8:3002::/64
awplus(config-dhcp6)# option 175 2001:0db8:3003::/64
```

To add the option 179 to a pool, and give the option the value `123456`, use the following command:

```
awplus(config-dhcp6)# option 179 123456
```

To add a user-defined flag option with the name `perform-router-discovery`, use the following command:

```
awplus(config-dhcp6)# option perform-router-discovery yes
```

To clear all user-defined options from a DHCP address pool, use the following command:

```
awplus(config-dhcp6)# no option
```

To clear a user-defined option, named `tftp-server-name`, use the following command:

```
awplus(config-dhcp6)# no option tftp-server-name
```

Related commands

- [dns-server \(DHCPv6\)](#)
- [ipv6 dhcp option](#)
- [ipv6 dhcp pool](#)
- [show ipv6 dhcp pool](#)

prefix-delegation pool

Overview Use this command in DHCPv6 Configuration mode to add a DHCPv6 server prefix-delegation pool entry to the current DHCPv6 pool configuration. You must define a DHCPv6 server prefix-delegation pool using the `ipv6 dhcp pool` command before using this command.

Use the **no** variant of this command to remove a DHCPv6 server prefix-delegation pool from the current DHCPv6 pool configuration.

Syntax `prefix-delegation pool <DHCPv6-poolname> [lifetime {<valid-time>|infinite} {<preferred-time>|infinite}]`
`no prefix-delegation pool <DHCPv6-poolname>`

Parameter	Description
<code><DHCPv6-poolname></code>	Description used to identify this DHCPv6 server pool. Valid characters are any printable character. If the name contains spaces then you must enclose it in "quotation marks".
<code>lifetime</code>	Optional. Specify a time period for the hosts to remember router advertisements (RAs). If you specify this parameter then you must also specify a <i>valid-time</i> and a <i>preferred-time</i> value. See the Usage notes below this parameter table for a description of preferred and valid lifetimes and how these determine deprecated or invalid IPv6 addresses upon expiry.
<code><valid-time></code>	Specify a valid lifetime in seconds in the range <code><5-315360000></code> .
<code>infinite</code>	Specify an infinite valid lifetime or an infinite preferred lifetime, or both, when using this keyword.
<code><preferred-time></code>	Specify a valid lifetime in seconds in the range <code><5-315360000></code> .

Default No IPv6 local prefix pool is specified by default.

Mode DHCPv6 Configuration

Usage notes The DHCPv6 server assigns prefixes dynamically from an IPv6 local prefix pool, which is configured using the `ipv6 local pool` command and is associated with a DHCPv6 configuration pool using this command. When the server receives a prefix request from a client, it attempts to obtain unassigned prefixes from the pool. After the client releases the previously assigned prefixes, the server returns the prefixes to the pool for reassignment.

Preferred IPv6 addresses or prefixes are available to interfaces for unrestricted use and are deprecated when the preferred timer expires.

Deprecated IPv6 addresses and prefixes are available for use and are discouraged but not forbidden. A deprecated address or prefix should not be used as a source

address or prefix, but packets sent from deprecated addresses or prefixes are delivered as expected.

An IPv6 address or prefix becomes invalid and is not available to an interface when the valid lifetime timer expires. Invalid addresses or prefixes should not appear as the source or destination for a packet.

Example This example adds DHCPv6 Prefix Delegation pool pd_pool1 to DHCPv6 pool pool1:

```
awplus# configure terminal
awplus(config)# ipv6 local pool pd_pool1 2001:0db8::/48 56
awplus(config)# ipv6 dhcp pool pool1
awplus(config-dhcp6)# prefix-delegation pool pd_pool1
```

Related commands

- [ipv6 dhcp pool](#)
- [ipv6 local pool](#)
- [show ipv6 dhcp pool](#)

service dhcp-relay

Overview This command enables the DHCP Relay Agent on the device. However, on a given IP interface, no DHCP forwarding takes place until at least one DHCP server is specified to forward/relay all clients' DHCP packets to.

The **no** variant of this command disables the DHCP Relay Agent on the device for all interfaces.

Syntax `service dhcp-relay`
`no service dhcp-relay`

Mode Global Configuration

Usage notes A maximum number of 400 DHCP Relay Agents (one per interface) can be configured on the device. Once this limit has been reached, any further attempts to configure DHCP Relay Agents will not be successful.

Default The DHCP-relay service is enabled by default.

Examples To enable the DHCP relay global function, use the commands:

```
awplus# configure terminal
awplus(config)# service dhcp-relay
```

To disable the DHCP relay global function, use the commands:

```
awplus# configure terminal
awplus(config)# no service dhcp-relay
```

Related commands

- [ip dhcp-relay agent-option](#)
- [ip dhcp-relay agent-option checking](#)
- [ip dhcp-relay information policy](#)
- [ip dhcp-relay maxhops](#)
- [ip dhcp-relay server-address](#)

show counter dhcp-relay

Overview This command shows counters for the DHCP Relay Agent on your device.

For information on filtering and saving command output, see the [“Getting Started with AlliedWare Plus” Feature Overview and Configuration Guide](#).

Syntax show counter dhcp-relay

Syntax (VRF-lite) show counter dhcp-relay [vrf <vrf-name>|global]

Parameter	Description
vrf	Display the output for a VRF instance
<vrf-name>	The name of the specific VRF instance.
global	Display the output for the Global VRF instance

Mode User Exec and Privileged Exec

Examples To display counters for the DHCP Relay Agent on your device, use the following command:

```
awplus# show counter dhcp-relay
```

Output Figure 55-2: Example output from the **show counter dhcp-relay** command

```
awplus#show counter dhcp-relay

DHCP relay counters
Requests In           ..... 4
Replies In           ..... 4
Relayed To Server    ..... 4
Relayed To Client    ..... 4
Out To Server Failed ..... 0
Out To Client Failed ..... 0
Invalid hlen         ..... 0
Bogus giaddr         ..... 0
Corrupt Agent Option ..... 0
Missing Agent Option ..... 0
Bad Circuit ID       ..... 0
Missing Circuit ID   ..... 0
Bad Remote ID        ..... 0
Missing Remote ID    ..... 0
Option Insert Failed ..... 0
DHCPv6 Requests In  ..... 0
DHCPv6 Replies In   ..... 0
DHCPv6 Relayed to Server ..... 0
DHCPv6 Relayed to Client ..... 0
```

Output (VRF-lite) Figure 55-3: Example output from the **show counter dhcp-relay** command for VRF instance red

```
DHCP relay counters

[VRF red]
Requests In ..... 4
Replies In ..... 4
Relayed To Server ..... 4
Relayed To Client ..... 4
Out To Server Failed ..... 0
Out To Client Failed ..... 0
Invalid hlen ..... 0
Bogus giaddr ..... 0
Corrupt Agent Option ..... 0
Missing Agent Option ..... 0
Bad Circuit ID ..... 0
Missing Circuit ID ..... 0
Option Insert Failed ..... 0
```

Parameter	Description
Requests In	The number of DHCP Request messages received from clients.
Replies In	The number of DHCP Reply messages received from servers.
Relayed To Server	The number of DHCP Request messages relayed to servers.
Relayed To Client	The number of DHCP Reply messages relayed to clients.
Out To Server Failed	The number of failures when attempting to send request messages to servers. This is an internal debugging counter.
Out To Client Failed	The number of failures when attempting to send reply messages to clients. This is an internal debugging counter.
Invalid hlen	The number of incoming messages dropped due to an invalid hlen field.
Bogus giaddr	The number of incoming DHCP Reply messages dropped due to the bogus giaddr field.
Corrupt Agent Option	The number of incoming DHCP Reply messages dropped due to a corrupt relay agent information option field. Note that Agent Option counters only increment on errors occurring if the <code>ip dhcp-relay agent-option</code> command is configured for an interface. Messages generating the errors are only dropped if the <code>ip dhcp-relay agent-option checking</code> command is configured on the interface as well as the <code>ip dhcp-relay agent-option</code> command.

Parameter	Description
Missing Agent Option	The number of incoming DHCP Reply messages dropped due to a missing relay agent information option field. Note that Agent Option counters only increment on errors occurring if the <code>ip dhcp-relay agent-option</code> command is configured for an interface. Messages generating the errors are only dropped if the <code>ip dhcp-relay agent-option checking</code> command is configured on the interface as well as the <code>ip dhcp-relay agent-option</code> command.
Bad Circuit ID	The number of incoming DHCP Reply messages dropped due to a bad circuit ID. Note that Agent Option counters only increment on errors occurring if the <code>ip dhcp-relay agent-option</code> command is configured for an interface. Messages generating the errors are only dropped if the <code>ip dhcp-relay agent-option checking</code> command is configured on the interface as well as the <code>ip dhcp-relay agent-option</code> command.
Missing Circuit ID	The number of incoming DHCP Reply messages dropped due to a missing circuit ID. Note that Agent Option counters only increment on errors occurring if the <code>ip dhcp-relay agent-option</code> command is configured for an interface. Messages generating the errors are only dropped if the <code>ip dhcp-relay agent-option checking</code> command is configured on the interface as well as the <code>ip dhcp-relay agent-option</code> command.
Bad Remote ID	The number of incoming DHCP Reply messages dropped due to a bad remote ID. Note that Agent Option counters only increment on errors occurring if the <code>ip dhcp-relay agent-option</code> command is configured for an interface. Messages generating the errors are only dropped if the <code>ip dhcp-relay agent-option checking</code> command is configured on the interface as well as the <code>ip dhcp-relay agent-option</code> command.
Missing Remote ID	The number of incoming DHCP Reply messages dropped due to a missing remote ID. Note that Agent Option counters only increment on errors occurring if the <code>ip dhcp-relay agent-option</code> command is configured for an interface. Messages generating the errors are only dropped if the <code>ip dhcp-relay agent-option checking</code> command is configured on the interface as well as the <code>ip dhcp-relay agent-option</code> command.

Parameter	Description
Option Insert Failed	The number of incoming DHCP Request messages dropped due to an error adding the DHCP Relay Agent information (option-82). This counter increments when: <ul style="list-style-type: none">the DHCP Relay Agent is set to drop packets with the DHCP Relay Agent Option 82 field already filled by another DHCP Relay Agent. This policy is set with the <code>ip dhcp-relay information policy</code> command.there is a packet error that stops the DHCP Relay Agent from being able to append the packet with its DHCP Relay Agent Information Option (Option 82) field.
Note that the following parameters are only used on the Global VRF instance when DHCPv6 is running	
DHCPv6 Requests In	The number of incoming DHCPv6 Request messages.
DHCPv6 Replies In	The number of incoming DHCPv6 Reply messages.
DHCPv6 Relayed to Server	The number of DHCPv6 messages relayed to the server.
DHCPv6 Relayed to Client	The number of DHCPv6 messages relayed to the client.

show counter ipv6 dhcp-client

Overview Use this command in User Exec or Privilege Exec mode to show DHCPv6 client counter information. See [show counter ipv6 dhcp-server](#) for DHCPv6 server information.

For information on filtering and saving command output, see the [“Getting Started with AlliedWare Plus” Feature Overview and Configuration Guide](#).

Syntax `show counter ipv6 dhcp-client`

Mode User Exec and Privileged Exec

Example To display the DHCPv6 client counter information, use the command:

```
awplus# show counter ipv6 dhcp-client
```

Output Figure 55-4: Example output from the **show counter ipv6 dhcp-client** command

```
awplus#show counter ipv6 dhcp-client
SOLICIT out          ..... 20
ADVERTISE in         ..... 12
REQUEST out          ..... 1
CONFIRM out          ..... 0
RENEW out            ..... 0
REBIND out           ..... 0
REPLY in             ..... 0
RELEASE out          ..... 0
DECLINE out          ..... 0
INFORMATION-REQUEST out ..... 0
```

Table 1: Parameters in the output of the **show counter ipv6 dhcp-client** command

Parameter	Description
SOLICIT out	Displays the count of SOLICIT messages sent by the DHCPv6 client.
ADVERTISE in	Displays the count of ADVERTISE messages received by the DHCPv6 client.
REQUEST out	Displays the count of REQUEST messages sent by the DHCPv6 client.
CONFIRM out	Displays the count of CONFIRM messages sent by the DHCPv6 client.
RENEW out	Displays the count of RENEW messages sent by the DHCPv6 client.

Table 1: Parameters in the output of the **show counter ipv6 dhcp-client** command (cont.)

Parameter	Description
REBIND out	Displays the count of REBIND messages sent by the DHCPv6 client.
REPLY in	Displays the count of REPLY messages received by the DHCPv6 client.
RELEASE out	Displays the count of RELEASE messages sent by the DHCPv6 client.
DECLINE out	Displays the count of DECLINE messages sent by the DHCPv6 client.
INFORMATION-REQUEST out	Displays the count of INFORMATION-REQUEST messages sent by the DHCPv6 client.

Related commands [show counter ipv6 dhcp-server](#)

show counter ipv6 dhcp-server

Overview Use this command in User Exec or Privileged Exec mode to show DHCPv6 server counter information. See [show counter ipv6 dhcp-client](#) for DHCPv6 client information.

For information on filtering and saving command output, see the [“Getting Started with AlliedWare Plus” Feature Overview and Configuration Guide](#).

Syntax `show counter ipv6 dhcp-server`

Mode User Exec and Privileged Exec

Example To display the DHCPv6 server counter information, use the command:

```
awplus# show counter ipv6 dhcp-server
```

Output Figure 55-5: Example output from the **show counter ipv6 dhcp-server** command

```
awplus#show counter ipv6 dhcp-server
SOLICIT in          ..... 20
ADVERTISE out       ..... 12
REQUEST in          ..... 1
CONFIRM in          ..... 0
RENEW in            ..... 0
REBIND in           ..... 0
REPLY out           ..... 0
RELEASE in          ..... 0
DECLINE in          ..... 0
INFORMATION-REQUEST in ..... 0
RELAY FORWARD in   ..... 0
LEASEQUERY in      ..... 0
DHCPv4 QUERY in    ..... 0
```

Table 2: Parameters in the output of the **show counter ipv6 dhcp-server** command

Parameter	Description
SOLICIT in	Displays the count of SOLICIT messages received by the DHCPv6 server.
ADVERTISE out	Displays the count of ADVERTISE messages sent by the DHCPv6 server.
REQUEST in	Displays the count of REQUEST messages received by the DHCPv6 server.
CONFIRM in	Displays the count of CONFIRM messages received by the DHCPv6 server.

Table 2: Parameters in the output of the **show counter ipv6 dhcp-server** command (cont.)

Parameter	Description
RENEW in	Displays the count of RENEW messages received by the DHCPv6 server.
REBIND in	Displays the count of REBIND messages received by the DHCPv6 server.
REPLY out	Displays the count of REPLY messages sent by the DHCPv6 server.
RELEASE in	Displays the count of RELEASE messages received by the DHCPv6 server.
DECLINE in	Displays the count of DECLINE messages received by the DHCPv6 server.
INFORMATION-REQUEST in	Displays the count of INFORMATION-REQUEST messages received by the DHCPv6 server
RELAY FORWARD in	Displays the count of Relay forward in messages received by the DHCPv6 server
LEASEQUERY in	Displays the count of LEASE QUERY messages received by the DHCPv6 server
DHCPv4 QUERY in	Displays the count of DHCPv4 QUERY messages received by the DHCPv6 server

Related commands [show counter ipv6 dhcp-client](#)

show ip dhcp-relay

Overview This command shows the configuration of the DHCP Relay Agent on each interface.

For information on filtering and saving command output, see the [“Getting Started with AlliedWare Plus” Feature Overview and Configuration Guide](#).

Syntax `show ip dhcp-relay [interface <interface-name>]`

Syntax (VRF-lite) `show ip dhcp-relay [vrf <name>|global] [interface <interface-name>]`

Parameter	Description
<interface-name>	Name of a specific interface. This displays the DHCP configuration for the specified interface only.
vrf	Apply this command to a VRF instance.
<vrf-name>	The name of the VRF instance.
global	The Global VRF instance.

Mode User Exec and Privileged Exec

Example To display the DHCP Relay Agent’s configuration on the interface vlan2, use the command:

```
awplus# show ip dhcp-relay interface vlan2
```

Output Figure 55-6: Example output from the **show ip dhcp-relay** command

```
DHCP Relay Service is enabled

vlan2 is up, line protocol is up
Maximum hop count is 10
Insertion of Relay Agent Option is disabled
Checking of Relay Agent Option is disabled
The Remote Id string for Relay Agent Option is 0000.cd28.074c
Relay information policy is to append new relay agent
information
List of servers : 192.168.1.200
```

Output (VRF-lite) Figure 55-7: Example output from the **show ip dhcp-relay** command applied for VRF instance red

```
DHCP Relay Service is enabled

[VRF: red]
vlan2 is up, line protocol is up
Maximum hop count is 10
Maximum DHCP message length is 1400
Insertion of Relay Agent Option is enabled
Checking of Relay Agent Option is disabled
The Remote Id string for Relay Agent Option is 0000.cd28.074c
Relay Information policy is to replace existing relay agent
information
List of servers :    192.168.1.3
```

Related commands

- [ip dhcp-relay agent-option](#)
- [ip dhcp-relay agent-option checking](#)
- [ip dhcp-relay information policy](#)
- [ip dhcp-relay maxhops](#)
- [ip dhcp-relay server-address](#)

Command changes Version 5.4.6-2.1: VRF-lite support added.

show ipv6 dhcp

Overview Use this command in User Exec or Privileged Exec mode to show the DHCPv6 unique identifier (DUID) configured on your device.

For information on filtering and saving command output, see the [“Getting Started with AlliedWare Plus” Feature Overview and Configuration Guide](#).

Syntax `show ipv6 dhcp`

Mode User Exec and Privileged Exec

Usage notes The DUID is based on the link-layer address for both DHCPv6 client and DHCPv6 server identifiers. The device uses the MAC address from the lowest interface number for the DUID.

The DUID is used by a DHCPv6 client to obtain an IPv6 address from a DHCPv6 server. A DHCPv6 server compares the DUID with its database of DUIDs and sends configuration data for an IPv6 address plus the preferred and valid lease time values to a DHCPv6 client.

Example To display the DUID configured on your device, use the command:

```
awplus# show ipv6 dhcp
```

Output Figure 55-8: Example output from the **show ipv6 dhcp** command

```
awplus#show ipv6 dhcp
DHCPv6 Server DUID: 0001000117ab6876001577f7ba23
```

Related commands [ipv6 address dhcp](#)

show ipv6 dhcp binding

Overview Use this command in User Exec or Privileged Exec mode to show the IPv6 address entries that the DHCPv6 server leases to DHCPv6 clients. Note that applying this command with the optional *summary* keyword parameter displays the number of addresses per pool, but not the address or prefix entries per pool.

For information on filtering and saving command output, see the [“Getting Started with AlliedWare Plus” Feature Overview and Configuration Guide](#).

Syntax `show ipv6 dhcp binding [summary]`

Parameter	Description
<code>summary</code>	Optional. Specify the summary keyword to display summarized information for DHCPv6 server leases to client nodes, displaying the number of address entries per pool, not the addresses or prefixes.

Mode User Exec and Privileged Exec

Example 1 To display the total DHCPv6 leasing address entries for all pools, use the command:

```
awplus# show ipv6 dhcp binding summary
```

Output Figure 55-9: Example output from the **show ipv6 dhcp binding summary** command

```
awplus# show ipv6 dhcp binding summary
Pool Name                Number of Leased Addresses
-----
ia-na1                    3
ia-pd1                    5
Total in all Pools:      8
```

Table 3: Parameters in the output of the **show ipv6 dhcp binding summary** command

Parameter	Description
Pool Name	Displays a list of all the pool names.
Number of Leased Addresses	Displays the number of leased address entries for the pool.
Total in all Pools	Displays the total number of leased address entries for all pools.

Example 2 To display addresses, prefixes, and lifetimes for all DHCPv6 leasing entries by pool, enter:

```
awplus# show ipv6 dhcp binding
```

Output Figure 55-10: Example output from the **show ipv6 dhcp binding** command

```
awplus#show ipv6 dhcp binding
Pool ia-na1
  Address 2002:0:3c0::1
    client IAID 77f7ba23, DUID 0001000117c4bbb4001577f7ba23
    preferred lifetime 604800, valid lifetime 2592000
    starts at 20 Aug 2012 18:38:29
    expires at 19 Sep 2012 18:38:29
Pool ia-pd1
  Prefix 2002:0:3c0::/42
    client IAID 77f7ba23, DUID 0001000117c4bbb4001577f7ba23
    preferred lifetime 604800, valid lifetime 2592000
    starts at 20 Aug 2012 18:38:29
    expires at 19 Sep 2012 18:38:29
```

Table 4: Parameters in the output of the **show ipv6 dhcp binding** command

Parameter	Description
Address	Address delegated to the indicated IAID and DUID. See the IAID and DUID descriptions below for further information.
Prefix	Prefix delegated to the indicated IAID and DUID. See the IAID and DUID descriptions below for further information.
DUID	DHCPv6 unique identifier (DUID) (see RFC 3315). Each DHCPv6 client has as DUID. DHCPv6 servers use DUIDs to identify clients for the association of IAs (Identity Associations) with DHCPv6 clients. DHCPv6 clients use DUIDs to identify a DHCPv6 server.
IAID	Identify Association Identifier (IAID) (see RFC 3315). IAIDs are identifiers for IAs (Identity Associations), where an IA is a collection of IPv6 addresses assigned to a DHCPv6 client. Each IA has an associated IAD. Each DHCPv6 client may have more than one IA assigned to it. Each IA holds one type of address.
preferred lifetime	The preferred lifetime setting in seconds for the specified IAID and DUID. Preferred IPv6 addresses or prefixes are available to interfaces for unrestricted use and are deprecated when the preferred timer expires. Deprecated IPv6 addresses and prefixes are available for use and are discouraged but not forbidden. A deprecated address or prefix should not be used as a source address or prefix, but packets sent from deprecated addresses or prefixes are delivered as expected.
valid lifetime	The valid lifetime setting in seconds for the specified IAID and DUID. An IPv6 address or prefix becomes invalid and is not available to an interface when the valid lifetime timer expires. Invalid addresses or prefixes should not appear as the source or destination for a packet.

Table 4: Parameters in the output of the **show ipv6 dhcp binding** command

Parameter	Description
starts at	The date and time at which the valid lifetime expires.
expires at	The date and time at which the valid lifetime expires.

**Related
commands**

[clear ipv6 dhcp binding](#)
[ipv6 dhcp pool](#)
[show ipv6 dhcp pool](#)

show ipv6 dhcp interface

Overview Use this command in User Exec or Privileged Exec mode to display DHCPv6 information for a specified interface, or all interfaces when entered without the interface parameter.

For information on filtering and saving command output, see the [“Getting Started with AlliedWare Plus” Feature Overview and Configuration Guide](#).

Syntax `show ipv6 dhcp interface [<interface-name>]`

Parameter	Description
<interface-name>	Optional. Specify the name of the interface to show DHCPv6 information about. Omit this optional parameter to display DHCPv6 information for all interfaces DHCPv6 is configured on.

Mode User Exec and Privileged Exec

Example To display DHCPv6 information for all interfaces DHCPv6 is configured on, use the command:

```
awplus# show ipv6 dhcp interface
```

Output Figure 55-11: Example output from the **show ipv6 dhcp interface** command

```
awplus# show ipv6 dhcp interface
vlan1 is in client mode
Address 1001::3c0:1
    preferred lifetime 9000, valid lifetime 5000
    starts at 20 Jan 2021 09:21:35
    expires at 20 Jan 2021 10:25:32
```

Example 2 To display DHCPv6 information for interface vlan2, use the command:

```
awplus# show ipv6 dhcp interface vlan2
```

Output Figure 55-12: Example output from the **show ipv6 dhcp interface** command for a specific interface

```
awplus# show ipv6 dhcp interface vlan2
vlan2 is in client (Prefix-Delegation) mode
Prefix name pd1
    prefix 2002:0:3c0::/42
    preferred lifetime 604800, valid lifetime 2592000
    starts at 20 Aug 2021 09:21:33
    expires at 19 Sep 2021 09:21:33
```

Table 5: Parameters in the output of the **show counter dhcp-client** command

Parameter	Description
<interface> is in server/client/ (Prefix-Delegation) mode	Displays whether the specified interface is in server or client mode and whether prefix-delegation is applied to an interface.
Address	Displays the address of the DHCPv6 server on the interface.
Prefix name	Displays the IPv6 general prefix pool name, where prefixes are stored for the interface.
Using pool	Displays the name of the pool used by the interface.
Preference	Displays the preference value for the DHCPv6 server.

Related commands [ipv6 dhcp client pd](#)

show ipv6 dhcp pool

Overview Use this command in User Exec or Privileged Exec mode to display the configuration details and system usage of the DHCPv6 address pools configured on the device.

For information on filtering and saving command output, see the [“Getting Started with AlliedWare Plus” Feature Overview and Configuration Guide](#).

Syntax `show ipv6 dhcp pool [<DHCPv6-address-pool-name>]`

Parameter	Description
<DHCPv6-address-pool-name>	Name of a specific DHCPv6 address pool. This displays the configuration of the specified DHCPv6 address pool only.

Mode User Exec and Privileged Exec

Example `awplus# show ipv6 dhcp pool`

Output Figure 55-13: Example output from the **show ipv6 dhcp pool** command

```
awplus# show ipv6 dhcp pool
DHCPv6 Pool: ia-na
Address Prefix : 1001::/64
                Lifetime: 2592000(valid), 604800(preferred)
DNS Server: 2001::1
DNS Server: 2001::2
Domain Name: example.com
Domain Name: example.co.jp
SNTP Server: 2001::5
SNTP Server: 2001::6
Option Code : 150
                Value: [ASCII] test-test
DHCPv6 Pool: ia-pd
PD Pool Name: pd1
Prefix : 2002::/38-42
Lifetime : 2592000(valid), 604800(preferred)
```

Table 6: Parameters in the output of the **show ipv6dhcp pool** command

Parameter	Description
DHCPv6 Pool	Name of the DHCPv6 pool.
Address Prefix	Address prefix to the DHCPv6 pool.

Table 6: Parameters in the output of the **show ipv6dhcp pool** command (cont.)

Parameter	Description
Address Lifetime	Valid and preferred lifetimes to the DHCPv6 pool. Preferred IPv6 addresses or prefixes are available to interfaces for unrestricted use and are deprecated when the preferred timer expires. Deprecated IPv6 addresses and prefixes are available for use and are discouraged but not forbidden. A deprecated address or prefix should not be used as a source address or prefix, but packets sent from deprecated addresses or prefixes are delivered as expected. An IPv6 address or prefix becomes invalid and is not available to an interface when the valid lifetime timer expires. Invalid addresses or prefixes should not appear as the source or destination for a packet.
DNS Server	IPv6 address of the DNS Server
Domain name	URL for the domain name.
SNTP Server	IPv6 address of the SNTP (Simple Network Time Protocol) Server.
Option Code	DHCP Option code (see RFC 2132).
Option Value	DHCP Option value type (see RFC 2132).

Related commands [ipv6 dhcp pool](#)

sntp-address

Overview Use this command in DHCPv6 Configuration mode to add an SNTP Server IPv6 address to a DHCPv6 Server pool.

Use the **no** variant of this command to remove an SNTP Server IPv6 address from a DHCPv6 Server pool.

Syntax `sntp-address <ipv6-address>`
`no sntp-address <ipv6-address>`

Parameter	Description
<code><ipv6-address></code>	Specify an SNTP Server IPv6 address, in hexadecimal notation in the format X:X::X:X.

Mode DHCPv6 Configuration

Examples The following example adds an SNTP Server IPv6 address of 2001:0db8::/32 to the DHCPv6 pool named P2:

```
awplus# configure terminal
awplus(config)# ipv6 dhcp pool P2
awplus(config-dhcp6)# sntp-address 2001:0db8::/32
```

The following example removes an SNTP Server IPv6 address of 2001:0db8::/32 to the DHCPv6 pool named P2:

```
awplus# configure terminal
awplus(config)# ipv6 dhcp pool P2
awplus(config-dhcp6)# no sntp-address 2001:0db8::/32
```

Related commands

- [dns-server \(DHCPv6\)](#)
- [domain-name \(DHCPv6\)](#)
- [option \(DHCPv6\)](#)
- [show ipv6 dhcp pool](#)

56

NTP Commands

Introduction

Overview This chapter provides an alphabetical reference for commands used to configure the Network Time Protocol (NTP). For more information, see the [NTP Feature Overview and Configuration Guide](#).

The device can act as an NTP client to receive time from one or more NTP servers, and as an NTP server.

For information on filtering and saving command output, see the [“Getting Started with AlliedWare_Plus” Feature Overview and Configuration Guide](#).

- Command List**
- [“ntp authentication-key”](#) on page 3200
 - [“ntp broadcastdelay”](#) on page 3201
 - [“ntp master”](#) on page 3202
 - [“ntp peer”](#) on page 3203
 - [“ntp rate-limit”](#) on page 3205
 - [“ntp restrict”](#) on page 3206
 - [“ntp server”](#) on page 3208
 - [“ntp source”](#) on page 3210
 - [“show ntp associations”](#) on page 3212
 - [“show ntp counters”](#) on page 3214
 - [“show ntp counters associations”](#) on page 3215
 - [“show ntp status”](#) on page 3216

ntp authentication-key

Overview This command defines each of the authentication keys. Each key has a key number, a type (MD5 or SHA1), and a value.

The **no** variant of this disables the authentication key.

Syntax `ntp authentication-key <keynumber> md5 <key-string> [trusted]`
`ntp authentication-key <keynumber> sha1 <key-string> [trusted]`
`no ntp authentication-key <keynumber>`

Parameter	Description
<keynumber>	<1-4294967295> An identification number for the key.
md5	Define an MD5 key.
sha1	Define an SHA1 key.
<key-string>	The authentication key. For SHA1, this is a 20 hexadecimal character string. For MD5, this is a string of up to 31 ASCII characters.
trusted	Add this key to the list of authentication keys that this server trusts.

Mode Global Configuration

Examples To define an MD5 authentication key number 134343 and a key value 'mystring', use the commands:

```
awplus# configure terminal  
awplus(config)# ntp authentication-key 134343 md5 mystring
```

To disable the authentication key number 134343 with the key value 'mystring', use the commands:

```
awplus# configure terminal  
awplus(config)# no ntp authentication-key 134343
```

Command changes Version 5.4.9-2.1 sha1-encrypted parameter added.

ntp broadcastdelay

Overview Use this command to set the estimated round-trip delay for broadcast packets. Use the **no** variant of this command to reset the round-trip delay for broadcast packets to the default offset of 0 microseconds.

Syntax `ntp broadcastdelay <delay>`
`no ntp broadcastdelay`

Parameter	Description
<delay>	<1-999999> The broadcast delay in microseconds.

Default 0 microsecond offset, which can only be applied with the **no** variant of this command.

Mode Global Configuration

Examples To set the estimated round-trip delay to 23464 microseconds for broadcast packets, use these commands:

```
awplus# configure terminal
awplus(config)# ntp broadcastdelay 23464
```

To reset the estimated round-trip delay for broadcast packets to the default setting (0 microseconds), use these commands:

```
awplus# configure terminal
awplus(config)# no ntp broadcastdelay
```

ntp master

Overview Use this command to make the device to be an authoritative NTP server, even if the system is not synchronized to an outside time source.

Use the **no** variant of this command to stop the device being the designated NTP server.

Syntax `ntp master [<stratum>]`
`no ntp master`

Parameter	Description
<code><stratum></code>	<code><1-15></code> The stratum number defines the configured level that is set for this master within the NTP hierarchy. The default stratum number is 12.

Mode Global Configuration

Usage notes The stratum levels define the distance from the reference clock and exist to prevent cycles in the hierarchy. Stratum 1 is used to indicate time servers, which are more accurate than Stratum 2 servers. For more information on the Network Time Protocol go to: www.ntp.org

Examples To stop the device from being the designated NTP server, use the commands:

```
awplus# configure terminal  
awplus(config)# no ntp master
```

To make the device the designated NTP server with stratum number 2, use the commands:

```
awplus# configure terminal  
awplus(config)# ntp master 2
```

ntp peer

Overview Use this command to configure an NTP peer association. An NTP association is a peer association if this system is willing to either synchronize to the other system, or allow the other system to synchronize to it.

Use the **no** variant of this command to remove the configured NTP peer association.

Syntax `ntp peer {<peeraddress>|<peername>}`
`ntp peer {<peeraddress>|<peername>} [prefer] [key <key>]`
`[version <version>]`
`no ntp peer {<peeraddress>|<peername>}`

Parameter	Description
<peeraddress>	Specify the IP address of the peer, entered in the form A.B.C.D for an IPv4 address, or in the form X:X::X:X for an IPv6 address.
<peername>	Specify the peer hostname. The peer hostname can resolve to an IPv4 and an IPv6 address.
prefer	Prefer this peer when possible.
key <key>	<1-4294967295> Configure the peer authentication key.
version <version>	<1-4> Configure for this NTP version.

Mode Global Configuration

Examples See the following commands for options to configure NTP peer association, key and NTP version for the peer with an IPv4 address of 192.0.2.23:

```
awplus# configure terminal
awplus(config)# ntp peer 192.0.2.23
awplus(config)# ntp peer 192.0.2.23 prefer
awplus(config)# ntp peer 192.0.2.23 prefer version 4
awplus(config)# ntp peer 192.0.2.23 prefer version 4 key 1234
awplus(config)# ntp peer 192.0.2.23 version 4 key 1234
awplus(config)# ntp peer 192.0.2.23 version 4
awplus(config)# ntp peer 192.0.2.23 key 1234
```

To remove an NTP peer association for this peer with an IPv4 address of 192.0.2.23, use the following commands:

```
awplus# configure terminal
awplus(config)# no ntp peer 192.0.2.23
```

See the following commands for options to configure NTP peer association, key and NTP version for the peer with an IPv6 address of 2001:0db8:010d::1:

```
awplus# configure terminal
awplus(config)# ntp peer 2001:0db8:010d::1
awplus(config)# ntp peer 2001:0db8:010d::1 prefer
awplus(config)# ntp peer 2001:0db8:010d::1 prefer version 4
awplus(config)# ntp peer 2001:0db8:010d::1 prefer version 4 key
1234
awplus(config)# ntp peer 2001:0db8:010d::1 version 4 key 1234
awplus(config)# ntp peer 2001:0db8:010d::1 version 4
awplus(config)# ntp peer 2001:0db8:010d::1 key 1234
```

To remove an NTP peer association for this peer with an IPv6 address of 2001:0db8:010d::1, use the following commands:

```
awplus# configure terminal
awplus(config)# no ntp peer 2001:0db8:010d::1
```

**Related
commands** [ntp server](#)
[ntp source](#)

ntp rate-limit

Overview Use this command to enable NTP server response rate-limiting. Limiting NTP server responses can reduce network traffic when occurrences such as misconfigured or broken NTP clients poll the NTP server too frequently. Excessive polling can lead to network overload.

Use the **no** variant of this command to remove the rate-limit configuration.

Syntax `ntp rate-limit {interval<1-4096>|burst <1-255>|leak <2-16>}`
`no ntp rate-limit`

Parameter	Description
interval	The minimum interval between responses configured in seconds. The default interval is 8 seconds.
burst	The maximum number of responses that can be sent in a burst, temporarily exceeding the limit specified by the interval option. The default burst is 8 responses.
leak	The rate at which responses are randomly allowed even if the limits specified by the interval and burst options are exceeded. The default leak is 4, i.e. on average, every fourth request has a response.

Mode Global Configuration

Default Interval - 8 seconds.

Burst - 8 responses.

Leak - 4.

Example To configure an NTP rate-limiting interval of 30 seconds, use the following commands:

```
awplus# configure terminal
awplus(config)# ntp rate-limit interval 30
```

Related commands [ntp restrict](#)

Command changes Version 5.4.8-1.1: command added

ntp restrict

Overview Use this command to configure a restriction (allow or deny) on NTP packets or NTP functionality for a specific host/network or all hosts of a given IP family.

This means you can control host access to NTP service and NTP server status queries.

Use the **no** variant of this command to remove a restriction from one or more hosts.

Syntax

```
ntp restrict
{default-v4|default-v6|<host-address>|<host-subnet>}
{allow|deny}

ntp restrict
{default-v4|default-v6|<host-address>|<host-subnet>} query
{allow|deny}

ntp restrict
{default-v4|default-v6|<host-address>|<host-subnet>} serve
{allow|deny}

no ntp restrict
{default-v4|default-v6|<host-address>|<host-subnet>}
```

Parameter	Description
default-v4	Apply this restriction to all IPv4 hosts.
default-v6	Apply this restriction to all IPv6 hosts.
<host-address>	Apply this restriction to the specified IPv4 or IPv6 host. Enter an IPv4 address in the format A.B.C.D. Enter an IPv6 address in the format X::X:X.
<host-subnet>	Apply this restriction to the specified IPv4 subnet or IPv6 prefix. Enter an IPv4 subnet in the format A.B.C.D/M. Enter an IPv6 prefix in the format X::X/X.
query	Control NTP server status queries to matching hosts.
serve	Control NTP time service to matching hosts.
allow	Allow the configured restriction.
deny	Deny the configured restriction.

Default By default, time service is allowed to all hosts, and NTP server status querying is denied to all hosts.

Mode Global Configuration

Example To prevent all IPv4 hosts from accessing a device for NTP service, use the commands:

```
awplus# configure terminal
awplus(config)# ntp restrict default-v4 deny
```

To prevent the host 192.168.1.1 from accessing a device for NTP service, use the commands:

```
awplus# configure terminal
awplus(config)# ntp restrict 198.168.1.1 deny
```

To allow all hosts in the 10.10.10.0/24 subnet to access a device for NTP server status, use the commands:

```
awplus# configure terminal
awplus(config)# ntp restrict 10.10.10.0/24 query allow
```

Related commands [ntp rate-limit](#)

Command changes Version 5.4.8-1.1: command added

ntp server

Overview Use this command to configure an NTP server. This means that this system will synchronize to the other system, and not vice versa.

Use the **no** variant of this command to remove the configured NTP server.

Syntax

```
ntp server {<serveraddress>|<servername>}  
ntp server {<serveraddress>|<servername>} [prefer] [key <key>]  
[version <version>]  
no ntp server {<serveraddress>|<servername>}
```

Parameter	Description
<serveraddress>	Specify the IP address of the peer, entered in the form A.B.C.D for an IPv4 address, or in the form X:X::X.X for an IPv6 address.
<servername>	Specify the server hostname. The server hostname can resolve to an IPv4 and an IPv6 address.
prefer	Prefer this server when possible.
key <key>	<1-4294967295> Configure the server authentication key.
version <version>	<1-4> Configure for this NTP version.

Mode Global Configuration

Examples To obtain the time by synchronizing with the server at 192.0.1.23, use the commands:

```
awplus# configure terminal  
awplus(config)# ntp server 192.0.1.23
```

To obtain the time by synchronizing with the server at 192.0.1.23, and specify that this is the best server to use, use the commands:

```
awplus# configure terminal  
awplus(config)# ntp server 192.0.1.23 prefer
```

To obtain the time by synchronizing with the server at 2001:0db8:010e::2, use the commands:

```
awplus# configure terminal  
awplus(config)# ntp server 2001:0db8:010e::2
```

To obtain the time by synchronizing with the server at 2001:0db8:010e::2, and specify that this is the best server to use, use the commands:

```
awplus# configure terminal  
awplus(config)# ntp server 2001:0db8:010e::2 prefer
```

To stop using the time server at 2001:0db8:010e::2, use the commands:

```
awplus# configure terminal  
awplus(config)# no ntp server 2001:0db8:010e::2
```

**Related
commands** [ntp peer](#)
 [ntp source](#)

ntp source

Overview Use this command to configure an IPv4 or an IPv6 address for the NTP source interface. This command defines the socket used for NTP messages, and only applies to NTP client behavior.

Note that you cannot use this command when using AMF (Allied Telesis Management Framework).

Use the **no** variant of this command to remove the configured IPv4 or IPv6 address from the NTP source interface.

Syntax `ntp source <source-address>`
`no ntp source`

Parameter	Description
<code><source-address></code>	Specify the IP address of the NTP source interface, entered in the form A.B.C.D for an IPv4 address, or in the form X:X::X.X for an IPv6 address.

Default An IP address is selected based on the most appropriate egress interface used to reach the NTP peer if a configured NTP client source IP address is unavailable or invalid.

Mode Global Configuration

Usage notes Adding an IPv4 or an IPv6 address allows you to select which source interface NTP uses for peering. The IPv4 or IPv6 address configured using this command is matched to the interface.

When selecting a source IP address to use for NTP messages to the peer, if the configured NTP client source IP address is unavailable then default behavior will apply, and an alternative source IP address is automatically selected. This IP address is based on the most appropriate egress interface used to reach the NTP peer. The configured NTP client source IP may be unavailable if the interface is down, or an invalid IP address is configured that does not reside on the device.

Note that this command only applies to NTP client behavior. The egress interface that the NTP messages use to reach the NTP server is determined by the `ntp peer` and `ntp server` commands.

Examples To configure the NTP source interface with the IPv4 address 192.0.2.23, enter the commands:

```
awplus# configure terminal
awplus(config)# ntp source 192.0.2.23
```

To configure the NTP source interface with the IPv6 address 2001:0db8:010e::2, enter the commands:

```
awplus# configure terminal
awplus(config)# ntp source 2001:0db8:010e::2
```

To remove a configured address for the NTP source interface, use the following commands:

```
awplus# configure terminal
awplus(config)# no ntp source
```

Related commands

- [ntp peer](#)
- [ntp server](#)

show ntp associations

Overview Use this command to display the status of NTP associations.

Syntax show ntp associations

Mode User Exec and Privileged Exec

Example See the sample output of the **show ntp associations** command displaying the status of NTP associations.

Table 56-1: Example output from **show ntp associations**

```
awplus#show ntp associations
remote          refid          st t when poll reach  delay  offset disp
-----
*server1.example.com
                192.0.2.2      4 u  47  64  377  0.177  0.021  0.001
+192.168.1.10   10.32.16.80   5 u  46  64  377  0.241  -0.045 0.000
* system peer, # backup, + candidate, - outlier, x false ticker
```

Table 56-2: Parameters in the output from **show ntp associations**

Parameter	Description
* system peer	The peer that NTP uses to calculate variables like the offset and root dispersion of this AlliedWare Plus device. NTP passes these variables to the clients using this AlliedWare Plus device.
# backup	Peers that are usable, but are not among the first six peers sorted by synchronization distance. These peers may not be used.
+ candidate	Peers that the NTP algorithm has determined can be used, along with the system peer, to discipline the clock (i.e. to set the time on the AlliedWare Plus device).
- outlier	Peers that are not used because their time is significantly different from the other peers.
x false ticker	Peers that are not used because they are not consider trustworthy.
space	Peers that are not used because they are, for example, unreachable.
remote	The peer IP address
refid	The IP address of the reference clock, or an abbreviation indicating the type of clock (e.g. GPS indicates that the server uses GPS for the reference clock). INIT indicates that the reference clock is initializing, so it is not operational.

Table 56-2: Parameters in the output from **show ntp associations** (cont.)

Parameter	Description
st	The stratum, which is the number of hops between the server and the accurate time source such as an atomic clock.
t	Type, one of: u: unicast or anycast client b: broadcast or multicast client l: local reference clock s: symmetric peer A: anycast server B: broadcast server M: multicast server
when	When last polled (seconds ago, h hours ago, or d days ago).
poll	Time between NTP requests from the device to the server.
reach	An indication of whether or not the NTP server is responding to requests. 0 indicates there has never been a successful poll; 1 indicates that the last poll was successful; 3 indicates that the last two polls were successful; 377 indicates that the last 8 polls were successful.
delay	The round trip communication delay to the remote peer or server, in milliseconds.
offset	The mean offset (phase) in the times reported between this local host and the remote peer or server (root mean square, milliseconds).
disp	The amount of clock error (in milliseconds) of the server due to clock resolution, network congestion, etc.

show ntp counters

Overview This command displays packet counters for NTP.

Syntax show ntp counters

Mode Privileged Exec

Example To display counters for NTP use the command:

```
awplus# show ntp counters
```

Figure 56-1: Example output from **show ntp counters**

```
awplus#show ntp counters
Server Received          4
Server Dropped          0
Client Sent              90
Client Received          76
Client Valid Received    76
```

Table 56-3: Parameters in the output from **show ntp counters**

Parameter	Description
Server Received	Number of NTP packets received from NTP clients.
Server Dropped	Number of NTP packets received from NTP clients but dropped.
Client Sent	Number of NTP packets sent to servers.
Client Received	Number of NTP packets received from servers
Client Valid Received	Number of valid NTP packets received from servers.

show ntp counters associations

Overview Use this command to display NTP packet counters for individual servers and peers.

Syntax show ntp counters associations

Mode Privileged Exec

Examples To display packet counters for each NTP server and peer that is associated with a device, use the command:

```
awplus# show ntp counters associations
```

Output Figure 56-2: Example output from **show ntp counters associations**

```
awplus#show ntp counters associations
Peer 2001::1
  sent:          -
  received:      -
Peer 10.37.219.100
  sent:          7
  received:      7
```

Table 56-4: Parameters in the output from **show ntp counters associations**

Parameter	Description
Peer	An NTP peer or server that the device is associated with.
sent	The number of NTP packets that this device sent to the peer.
received	The number of NTP packets that this device received from the peer.

Related commands [ntp restrict](#)

show ntp status

Overview Use this command to display the status of the Network Time Protocol (NTP).

Syntax show ntp status

Mode User Exec and Privileged Exec

Example To see information about NTP status, use the command:

```
awplus# show ntp status
```

For information about the output displayed by this command, see ntp.org.

Figure 56-3: Example output from **show ntp status**

```
awplus#show ntp status
Reference ID   : COA8010A (192.168.1.10)
Stratum       : 4
Ref time (UTC) : Fri Jun 15 05:32:38 2018
System time   : 0.000002004 seconds fast of NTP time
Last offset   : -0.002578615 seconds
RMS offset    : 0.000928071 seconds
Frequency     : 5.099 ppm slow
Residual freq : -9.120 ppm
Skew          : 17.486 ppm
Precision     : -21 (0.000000477 seconds)
Root delay    : 0.031749818 seconds
Root dispersion : 0.133974627 seconds
Update interval : 65.3 seconds
Leap status   : Normal
```

57

SNMP Commands

Introduction

Overview This chapter provides an alphabetical reference for commands used to configure SNMP. For more information, see:

- the [Support for Allied Telesis Enterprise_MIBs in AlliedWare Plus](#), for information about which MIB objects are supported.
- the [SNMP Feature Overview and Configuration_Guide](#).

For information on filtering and saving command output, see the [“Getting Started with AlliedWare Plus” Feature Overview and Configuration Guide](#).

- Command List**
- [“alias \(interface\)”](#) on page 3219
 - [“debug snmp”](#) on page 3220
 - [“show counter snmp-server”](#) on page 3221
 - [“show debugging snmp”](#) on page 3225
 - [“show running-config snmp”](#) on page 3226
 - [“show snmp-server”](#) on page 3227
 - [“show snmp-server community”](#) on page 3228
 - [“show snmp-server group”](#) on page 3229
 - [“show snmp-server trap”](#) on page 3230
 - [“show snmp-server user”](#) on page 3231
 - [“show snmp-server view”](#) on page 3232
 - [“snmp trap link-status”](#) on page 3233
 - [“snmp trap link-status suppress”](#) on page 3235
 - [“snmp-server”](#) on page 3237
 - [“snmp-server community”](#) on page 3239
 - [“snmp-server contact”](#) on page 3240

- [“snmp-server enable trap”](#) on page 3241
- [“snmp-server engineID local”](#) on page 3244
- [“snmp-server engineID local reset”](#) on page 3246
- [“snmp-server group”](#) on page 3247
- [“snmp-server host”](#) on page 3249
- [“snmp-server legacy-ifadminstatus”](#) on page 3252
- [“snmp-server location”](#) on page 3253
- [“snmp-server source-interface”](#) on page 3254
- [“snmp-server startup-trap-delay”](#) on page 3255
- [“snmp-server user”](#) on page 3256
- [“snmp-server view”](#) on page 3259
- [“undebg snmp”](#) on page 3260

alias (interface)

Overview Use this command to set an alias name for a port, as returned by the SNMP ifMIB in OID 1.3.6.1.2.1.31.1.1.1.18.

Use the **no** variant of this command to remove an alias name from a port.

Syntax `alias <ifAlias>`
`no alias`

Parameter	Description
<code><ifAlias></code>	64 character name for an interface in a network management system. All printable characters are valid.

Default Not set.

Mode Interface Configuration

Usage notes The interface alias can also be set via SNMP.

Third-party management systems often use standard MIBs to access device information. Network managers can specify an alias interface name to provide a non-volatile way to access the interface.

Example To configure the alias interface name 'uplink_a' for port1.0.1, use the following commands:

```
awplus# configure terminal
awplus(config)# interface port1.0.1
awplus(config-if)# alias uplink_a
```

To remove an alias interface name from port1.0.1, use the following commands:

```
awplus# configure terminal
awplus(config)# interface port1.0.1
awplus(config-if)# no alias
```

Command changes Version 5.4.8-2.1: command added

debug snmp

Overview This command enables SNMP debugging.

The **no** variant of this command disables SNMP debugging.

Syntax

```
debug snmp  
[all|detail|error-string|process|receive|send|xdump]  
  
no debug snmp  
[all|detail|error-string|process|receive|send|xdump]
```

Parameter	Description
all	Enable or disable the display of all SNMP debugging information.
detail	Enable or disable the display of detailed SNMP debugging information.
error-string	Enable or disable the display of debugging information for SNMP error strings.
process	Enable or disable the display of debugging information for processed SNMP packets.
receive	Enable or disable the display of debugging information for received SNMP packets.
send	Enable or disable the display of debugging information for sent SNMP packets.
xdump	Enable or disable the display of hexadecimal dump debugging information for SNMP packets.

Mode Privileged Exec and Global Configuration

Example To start SNMP debugging, use the command:

```
awplus# debug snmp
```

To start SNMP debugging, showing detailed SNMP debugging information, use the command:

```
awplus# debug snmp detail
```

To start SNMP debugging, showing all SNMP debugging information, use the command:

```
awplus# debug snmp all
```

Related commands

- [show debugging snmp](#)
- [terminal monitor](#)
- [undebug snmp](#)

show counter snmp-server

Overview This command displays counters for SNMP messages received by the SNMP agent.

Syntax show counter snmp-server

Mode User Exec and Privileged Exec

Example To display the counters for the SNMP agent, use the command:

```
awplus# show counter snmp-server
```

Output Figure 57-1: Example output from the **show counter snmp-server** command

```
SNMP-SERVER counters
inPkts                ..... 11
inBadVersions         ..... 0
inBadCommunityNames  ..... 0
inBadCommunityUses   ..... 0
inASNParseErrs       ..... 0
inTooBigs             ..... 0
inNoSuchNames        ..... 0
inBadValues           ..... 0
inReadOnlys          ..... 0
inGenErrs             ..... 0
inTotalReqVars       ..... 9
inTotalSetVars       ..... 0
inGetRequests        ..... 2
inGetNexts           ..... 9
inSetRequests        ..... 0
inGetResponses       ..... 0
inTraps              ..... 0
outPkts              ..... 11
outTooBigs           ..... 0
outNoSuchNames       ..... 2
outBadValues         ..... 0
outGenErrs           ..... 0
outGetRequests       ..... 0
outGetNexts          ..... 0
outSetRequests       ..... 0
outGetResponses      ..... 11
outTraps             ..... 0
UnsupportedSecLevels ..... 0
NotInTimeWindows     ..... 0
UnknownUserNames     ..... 0
UnknownEngineIDs     ..... 0
WrongDigest          ..... 0
DecryptionErrors     ..... 0
UnknownSecModels     ..... 0
InvalidMsgs          ..... 0
UnknownPDUHandlers   ..... 0
```

Table 1: Parameters in the output of the **show counter snmp-server** command

Parameter	Meaning
inPkts	The total number of SNMP messages received by the SNMP agent.
inBadVersions	The number of messages received by the SNMP agent for an unsupported SNMP version. It drops these messages. The SNMP agent on your device supports versions 1, 2C, and 3.
inBadCommunityNames	The number of messages received by the SNMP agent with an unrecognized SNMP community name. It drops these messages.
inBadCommunityUses	The number of messages received by the SNMP agent where the requested SNMP operation is not permitted from SNMP managers using the SNMP community named in the message.
inASNParseErrs	The number of ASN.1 or BER errors that the SNMP agent has encountered when decoding received SNMP Messages.
inTooBig	The number of SNMP PDUs received by the SNMP agent where the value of the error-status field is 'tooBig'. This is sent by an SNMP manager to indicate that an exception occurred when processing a request from the agent.
inNoSuchNames	The number of SNMP PDUs received by the SNMP agent where the value of the error-status field is 'noSuchName'. This is sent by an SNMP manager to indicate that an exception occurred when processing a request from the agent.
inBadValues	The number of SNMP PDUs received by the SNMP agent where the value of the error-status field is 'badValue'. This is sent by an SNMP manager to indicate that an exception occurred when processing a request from the agent.
inReadOnly	The number of valid SNMP PDUs received by the SNMP agent where the value of the error-status field is 'readOnly'. The SNMP manager should not generate a PDU which contains the value 'readOnly' in the error-status field. This indicates that there is an incorrect implementation of the SNMP.
inGenErrs	The number of SNMP PDUs received by the SNMP agent where the value of the error-status field is 'genErr'.

Table 1: Parameters in the output of the **show counter snmp-server** command

Parameter	Meaning
inTotalReqVars	The number of MIB objects that the SNMP agent has successfully retrieved after receiving valid SNMP Get-Request and Get-Next PDUs.
inTotalSetVars	The number of MIB objects that the SNMP agent has successfully altered after receiving valid SNMP Set-Request PDUs.
inGetRequests	The number of SNMP Get-Request PDUs that the SNMP agent has accepted and processed.
inGetNexts	The number of SNMP Get-Next PDUs that the SNMP agent has accepted and processed.
inSetRequests	The number of SNMP Set-Request PDUs that the SNMP agent has accepted and processed.
inGetResponses	The number of SNMP Get-Response PDUs that the SNMP agent has accepted and processed.
inTraps	The number of SNMP Trap PDUs that the SNMP agent has accepted and processed.
outPkts	The number of SNMP Messages that the SNMP agent has sent.
outTooBig	The number of SNMP PDUs that the SNMP agent has generated with the value 'tooBig' in the error-status field. This is sent to the SNMP manager to indicate that an exception occurred when processing a request from the manager.
outNoSuchNames	The number of SNMP PDUs that the SNMP agent has generated with the value 'noSuchName' in the error-status field. This is sent to the SNMP manager to indicate that an exception occurred when processing a request from the manager.
outBadValues	The number of SNMP PDUs that the SNMP agent has generated with the value 'badValue' in the error-status field. This is sent to the SNMP manager to indicate that an exception occurred when processing a request from the manager.
outGenErrs	The number of SNMP PDUs that the SNMP agent has generated with the value 'genErr' in the error-status field. This is sent to the SNMP manager to indicate that an exception occurred when processing a request from the manager.
outGetRequests	The number of SNMP Get-Request PDUs that the SNMP agent has generated.

Table 1: Parameters in the output of the **show counter snmp-server** command

Parameter	Meaning
outGetNexts	The number of SNMP Get-Next PDUs that the SNMP agent has generated.
outSetRequests	The number of SNMP Set-Request PDUs that the SNMP agent has generated.
outGetResponses	The number of SNMP Get-Response PDUs that the SNMP agent has generated.
outTraps	The number of SNMP Trap PDUs that the SNMP agent has generated.
UnsupportedSecLevels	The number of received packets that the SNMP agent has dropped because they requested a securityLevel unknown or not available to the SNMP agent.
NotInTimeWindows	The number of received packets that the SNMP agent has dropped because they appeared outside of the authoritative SNMP agent's window.
UnknownUserNames	The number of received packets that the SNMP agent has dropped because they referenced an unknown user.
UnknownEngineIDs	The number of received packets that the SNMP agent has dropped because they referenced an unknown snmpEngineID.
WrongDigest	The number of received packets that the SNMP agent has dropped because they didn't contain the expected digest value.
DecryptionErrors	The number of received packets that the SNMP agent has dropped because they could not be decrypted.
UnknownSecModels	The number of messages received that contain a security model that is not supported by the server. Valid for SNMPv3 messages only.
InvalidMsgs	The number of messages received where the security model is supported but the authentication fails. Valid for SNMPv3 messages only.
UnknownPDUHandlers	The number of times the SNMP handler has failed to process a PDU. This is a system debugging counter.

Related commands [show snmp-server](#)

show debugging snmp

Overview This command displays whether SNMP debugging is enabled or disabled.

Syntax `show debugging snmp`

Mode User Exec and Privileged Exec

Example To display the status of SNMP debugging, use the command:

```
awplus# show debugging snmp
```

Output Figure 57-2: Example output from the **show debugging snmp** command

```
Sntp (SMUX) debugging status:  
Sntp debugging is on
```

Related commands [debug snmp](#)

show running-config snmp

Overview This command displays the current configuration of SNMP on your device.

Syntax `show running-config snmp`

Mode Privileged Exec

Example To display the current configuration of SNMP on your device, use the command:

```
awplus# show running-config snmp
```

Output Figure 57-3: Example output from the **show running-config snmp** command

```
snmp-server contact AlliedTelesis
snmp-server location Philippines
snmp-server group grou1 auth read view1 write view1 notify view1
snmp-server view view1 1 included
snmp-server community public
snmp-server user user1 group1 auth md5 password priv des
password
```

Related commands [show snmp-server](#)

show snmp-server

Overview This command displays the status and current configuration of the SNMP server.

Syntax `show snmp-server`

Mode Privileged Exec

Example To display the status of the SNMP server, use the command:

```
awplus# show snmp-server
```

Output Figure 57-4: Example output from the **show snmp-server** command

```
SNMP Server ..... Enabled
IP Protocol ..... IPv4
SNMPv3 Engine ID (configured name) ... Not set
SNMPv3 Engine ID (actual) ..... 0x80001f888021338e4747b8e607
```

Related commands

- [debug snmp](#)
- [show counter snmp-server](#)
- [snmp-server](#)
- [snmp-server engineID local](#)
- [snmp-server engineID local reset](#)

show snmp-server community

Overview This command displays the SNMP server communities configured on the device. SNMP communities are specific to v1 and v2c.

Syntax `show snmp-server community`

Mode Privileged Exec

Example To display the SNMP server communities, use the command:

```
awplus# show snmp-server community
```

Output Figure 57-5: Example output from the **show snmp-server community** command

```
SNMP community information:
Community Name ..... public
Access ..... Read-only
View ..... none
```

Related commands [show snmp-server](#)
[snmp-server community](#)

show snmp-server group

Overview This command displays information about SNMP server groups. This command is used with SNMP version 3 only.

Syntax `show snmp-server group`

Mode Privileged Exec

Example To display the SNMP groups configured on the device, use the command:

```
awplus# show snmp-server group
```

Output Figure 57-6: Example output from the **show snmp-server group** command

```
SNMP group information:
  Group name ..... guireadgroup
  Security Level ..... priv
  Read View ..... guiview
  Write View ..... none
  Notify View ..... none

  Group name ..... guiwritegroup
  Security Level ..... priv
  Read View ..... none
  Write View ..... guiview
  Notify View ..... none
```

Related commands [show snmp-server](#)
[snmp-server group](#)

show snmp-server trap

Overview Use this command to display the status of the SNMP traps.

Syntax show snmp-server trap

Mode Privileged Exec

Example To display the SNMP traps status, use the commands:

```
awplus# show snmp-server trap
```

Output Figure 57-7: Example output from **show snmp-server trap**

```
awplus#show snmp-server trap
ATMF traps ..... Disabled
ATMF Link traps ..... Disabled
ATMF Node traps ..... Disabled
ATMF Guest Node traps ..... Enabled
ATMF Reboot Rolling traps ..... Disabled
Authentication failure ..... Disabled
BGP traps ..... Disabled
CWM Access Point traps ..... Enabled
DHCP Snooping traps ..... Disabled
EPSR traps ..... Disabled
LLDP traps ..... Disabled
Loop Protection traps ..... Disabled
MSTP traps ..... Disabled
NSM traps ..... Disabled
OSPF traps ..... Disabled
PIM traps ..... Disabled
Power-inline traps ..... Disabled
QoS Storm Protection traps ..... Enabled
RMON traps ..... Disabled
MAC address Thrash Limiting traps .... Disabled
UDLD traps ..... Disabled
VCS traps ..... Disabled
VRRP traps ..... Disabled
Wireless traps ..... Disabled
```

Related commands [show snmp-server](#)
[snmp-server enable trap](#)

show snmp-server user

Overview This command displays the SNMP server users and is used with SNMP version 3 only.

Syntax `show snmp-server user`

Mode Privileged Exec

Example To display the SNMP server users configured on the device, use the command:

```
awplus# show snmp-server user
```

Output Figure 57-8: Example output from the **show snmp-server user** command

Name	Group name	Auth	Privacy
freddy	guireadgroup	none	none

Related commands [show snmp-server](#)
[snmp-server user](#)

show snmp-server view

Overview This command displays the SNMP server views and is used with SNMP version 3 only.

Syntax `show snmp-server view`

Mode Privileged Exec

Example To display the SNMP server views configured on the device, use the command:

```
awplus# show snmp-server view
```

Output Figure 57-9: Example output from the **show snmp-server view** command

```
SNMP view information:
View Name ..... view1
OID ..... 1
Type ..... included
```

Related commands [show snmp-server](#)
[snmp-server view](#)

snmp trap link-status

Overview Use this command to enable SNMP to send link status notifications (traps) for the interfaces when an interface goes up (linkUp) or down (linkDown).

Use the **no** variant of this command to disable the sending of link status notifications.

Syntax `snmp trap link-status [enterprise]`
`no snmp trap link-status`

Parameter	Description
enterprise	Send an Allied Telesis enterprise type of link trap.

Default Disabled

Mode Interface Configuration

Usage notes The link status notifications can be enabled for the following interface types:

- switch port (e.g. port1.0.1)
- VLAN (e.g. vlan2)
- Ethernet (e.g. eth1)
- static and dynamic link aggregation (e.g. sa2, po2)

To specify where notifications are sent, use the [snmp-server host](#) command. To configure the device globally to send other notifications, use the [snmp-server enable trap](#) command.

Examples To enable SNMP to send link status notifications for port1.0.1 to port1.0.3 use the following commands:

```
awplus# configure terminal
awplus(config)# interface port1.0.1-port1.0.3
awplus(config-if)# snmp trap link-status
```

To disable the sending of link status notifications for port1.0.1, use the following commands:

```
awplus# configure terminal
awplus(config)# interface port1.0.1
awplus(config-if)# no snmp trap link-status
```

Related commands

- show interface
- snmp trap link-status suppress
- snmp-server enable trap
- snmp-server host

snmp trap link-status suppress

Overview Use this command to enable the suppression of link status notifications (traps) for the interfaces beyond the specified threshold, in the specified interval.

Use the **no** variant of this command to disable the suppression of link status notifications for the ports.

Syntax `snmp trap link-status suppress {time {<1-60>|default}|threshold {<1-20>|default}}`

`no snmp trap link-status suppress`

Parameter	Description
time	Set the suppression timer for link status notifications.
<1-60>	The suppress time in seconds.
default	The default suppress time in seconds (60).
threshold	Set the suppression threshold for link status notifications. This is the number of link status notifications after which to suppress further notifications within the suppression timer interval.
<1-20>	The number of link status notifications.
default	The default number of link status notifications (20).

Default By default, if link status notifications are enabled (they are enabled by default), the suppression of link status notifications is enabled: notifications that exceed the notification threshold (default 20) within the notification timer interval (default 60 seconds) are not sent.

Mode Interface Configuration

Usage notes An unstable network can generate many link status notifications. When notification suppression is enabled, a suppression timer is started when the first link status notification of a particular type (linkUp or linkDown) is sent for an interface.

If the threshold number of notifications of this type is sent before the timer reaches the suppress time, any further notifications of this type generated for the interface during the interval are not sent. At the end of the interval, the sending of link status notifications resumes, until the threshold is reached in the next interval.

Examples To suppress link status notifications for port1.0.1 to port1.0.3 after 10 notifications in 40 seconds, use the following commands:

```
awplus# configure terminal
awplus(config)# interface port1.0.1-port1.0.3
awplus(config-if)# snmp trap link-status suppress time 40
threshold 10
```

To stop suppressing link status notifications for port1.0.1, use the following commands:

```
awplus# configure terminal
awplus(config)# interface port1.0.1
awplus(config-if)# no snmp trap link-status suppress
```

Related commands

- [show interface](#)
- [snmp trap link-status](#)

snmp-server

Overview Use this command to enable the SNMP agent (server) on the device. The SNMP agent receives and processes SNMP packets sent to the device, and generates notifications (traps) that have been enabled by the [snmp-server enable trap](#) command.

Use the **no** variant of this command to disable the SNMP agent on the device. When SNMP is disabled, SNMP packets received by the device are discarded, and no notifications are generated. This does not remove any existing SNMP configuration.

Syntax `snmp-server [ip|ipv6]`
`no snmp-server [ip|ipv6]`

Parameter	Description
ip	Enable or disable the SNMP agent for IPv4.
ipv6	Enable or disable the SNMP agent for IPv6.

Default By default, the SNMP agent is enabled for both IPv4 and IPv6. If neither the **ip** parameter nor the **ipv6** parameter is specified for this command, then SNMP is enabled or disabled for both IPv4 and IPv6.

Mode Global Configuration

Examples To enable SNMP on the device for both IPv4 and IPv6, use the commands:

```
awplus# configure terminal  
awplus(config)# snmp-server
```

To enable the SNMP agent for IPv4 on the device, use the commands:

```
awplus# configure terminal  
awplus(config)# snmp-server ip
```

To disable the SNMP agent for both IPv4 and IPv6 on the device, use the commands:

```
awplus# configure terminal  
awplus(config)# no snmp-server
```

To disable the SNMP agent for IPv4, use the commands:

```
awplus(config)# no snmp-server ipv4
```

Related commands

- show snmp-server
- show snmp-server community
- show snmp-server user
- snmp-server community
- snmp-server contact
- snmp-server enable trap
- snmp-server engineID local
- snmp-server group
- snmp-server host
- snmp-server location
- snmp-server view

snmp-server community

Overview This command creates an SNMP community, optionally setting the access mode for the community. The default access mode is read-only. If view is not specified, the community allows access to all the MIB objects. The SNMP communities are only valid for SNMPv1 and v2c and provide very limited security. Communities should not be used when operating SNMPv3.

The **no** variant of this command removes an SNMP community. The specified community must already exist on the device.

Syntax `snmp-server community <community-name> {view <view-name>|ro|rw}`
`no snmp-server community <community-name>`

Parameter	Description
<community-name>	Community name. The community name is a case sensitive string of up to 20 characters.
view	Configure SNMP view. If view is not specified, the community allows access to all the MIB objects.
<view-name>	View name. The view name is a string up to 20 characters long and is case sensitive.
ro	Read-only community.
rw	Read-write community.

Mode Global Configuration

Example Use the following commands to create an SNMP community called 'public' with read-only access to all MIB variables from any management station:

```
awplus# configure terminal
awplus(config)# snmp-server community public ro
```

Use the following commands to remove an SNMP community called 'public'

```
awplus# configure terminal
awplus(config)# no snmp-server community public
```

Related commands [show snmp-server](#)
[show snmp-server community](#)
[snmp-server view](#)

snmp-server contact

Overview This command sets the contact information for the system. The contact name is:

- displayed in the output of the [show system](#) command
- stored in the MIB object sysContact

The **no** variant of this command removes the contact information from the system.

Syntax `snmp-server contact <contact-info>`
`no snmp-server contact`

Parameter	Description
<code><contact-info></code>	The contact information for the system, from 0 to 255 characters long. Valid characters are any printable character and spaces.

Mode Global Configuration

Example To set the system contact information to "support@alliedtelesis.co.nz", use the command:

```
awplus# configure terminal
awplus(config)# snmp-server contact
support@alliedtelesis.co.nz
```

Related commands [show system](#)
[snmp-server location](#)
[snmp-server group](#)

snmp-server enable trap

Overview Use this command to enable the transmission of the specified notifications (traps) on your device.

Note that the Environmental Monitoring traps defined in the AT-ENVMONv2-MIB are enabled by default.

Use the **no** variant of this command to disable the transmission of the specified notifications.

Syntax `snmp-server enable trap <trap-list>`
`no snmp-server enable trap <trap-list>`

Depending on your device model, you can enable some or all of the traps in the following table:

Parameter	Description
atmf	AMF traps.
atmfguestnode	AMF guest node traps.
atmflink	AMF link traps.
atmfnode	AMF node traps.
atmfrr	AMF reboot-rolling traps.
auth	Authentication failure.
bgp	BGP traps.
chassis	Chassis traps.
cwmap	Access Point traps with the AWC wireless manager.
dhcpsnooping	DHCP snooping and ARP security traps. These notifications must also be set using the ip dhcp snooping violation command, and/or the arp security violation arp security violation command.
epsr	EPSR traps.
g8032	G.8032 ERP traps.
lldp	Link Layer Discovery Protocol (LLDP) traps. These notifications must also be enabled using the lldp notifications command, and/or the lldp med-notifications command.
loopprot	Loop Protection traps.
mac-change	MAC address changed.
mac-move	MAC address moved between interface.
mac-threshold	MAC address table reaches a threshold limit.
mstp	MSTP traps.

Parameter	Description
nsm	NSM traps.
ospf	OSPF traps.
pim	PIM traps.
power-inline	Power-inline traps (Power Ethernet MIB RFC 3621).
qsp	QoS Storm Protection.
rmon	RMON traps.
thrash-limit	MAC address Thrash Limiting traps.
vcs	VCS traps.
vrrp	Virtual Router Redundancy (VRRP) traps.
ufo	Upstream Forwarding Only (UFO) traps.

Default Disabled

Mode Global Configuration

Usage notes This command cannot be used to enable link status notifications globally. To enable link status notifications for particular interfaces, use the [snmp trap link-status](#) command.

To specify where notifications are sent, use the [snmp-server host](#) command.

Note that you can enable (or disable) multiple traps with a single command, by specifying a space-separated list of traps.

Examples To enable the device to send a notification if an AMF node changes its status, use the following commands:

```
awplus# configure terminal
awplus(config)# snmp-server enable trap atmfnode
```

To enable the device to send MAC address Thrash Limiting traps, use the following commands:

```
awplus# configure terminal
awplus(config)# snmp-server enable trap thrash-limit
```

To disable the device from sending MAC address Thrash Limiting traps, use the following commands:

```
awplus# configure terminal
awplus(config)# no snmp-server enable trap thrash-limit
```

To enable the device to send OSPF and VRRP-related traps, use the following commands:

```
awplus# configure terminal
awplus(config)# snmp-server enable trap ospf vrrp
```

To disable OSPF traps being sent out by the device, use the following commands:

```
awplus# configure terminal  
awplus(config)# no snmp-server enable trap ospf
```

**Related
commands**

[show snmp-server](#)
[snmp trap link-status](#)
[snmp-server host](#)

**Command
changes**

Version 5.4.7-2.1: **ufo** parameter added
Version 5.5.1-1.1: **atmfguestnode** and **cwmap** parameters added
Version 5.5.1-2.1: **mac-change**, **mac-move**, and **mac-threshold** parameters added

snmp-server engineID local

Overview Use this command to configure the SNMPv3 engine ID. The SNMPv3 engine ID is used to uniquely identify the SNMPv3 agent on a device when communicating with SNMP management clients. Once an SNMPv3 engine ID is assigned, this engine ID is permanently associated with the device until you change it.

Use the **no** variant of this command to set the user defined SNMPv3 engine ID to a system generated pseudo-random value by resetting the SNMPv3 engine. The **no snmp-server engineID local** command has the same effect as the **snmp-server engineID local default** command.

Note that the [snmp-server engineID local reset](#) command is used to force the system to generate a new engine ID when the current engine ID is also system generated.

Syntax `snmp-server engineID local {<engine-id>|default}`
`no snmp-server engineID local`

Parameter	Description
<code><engine-id></code>	Specify SNMPv3 Engine ID value, a string of up to 27 characters.
<code>default</code>	Set SNMPv3 engine ID to a system generated value by resetting the SNMPv3 engine, provided the current engine ID is user defined. If the current engine ID is system generated, use the snmp-server engineID local reset command to force the system to generate a new engine ID.

Mode Global Configuration

Usage notes All devices must have a unique engine ID which is permanently set unless it is configured by the user.

Example To set the SNMPv3 engine ID to 800000cf030000cd123456, use the following commands:

```
awplus# configure terminal
awplus(config)# snmp-server engineID local
800000cf030000cd123456
```

To set a user defined SNMPv3 engine ID back to a system generated value, use the following commands:

```
awplus# configure terminal
awplus(config)# no snmp-server engineID local
```

Output The following example shows the engine ID values after configuration:

```
awplus(config)#snmp-server engineid local asdgdh231234d
awplus(config)#exit
awplus#show snmp-server

SNMP Server ..... Enabled
IP Protocol ..... IPv4
SNMPv3 Engine ID (configured name) ... asdgdh231234d
SNMPv3 Engine ID (actual) ..... 0x80001f888029af52e149198483

awplus(config)#no snmp-server engineid local
awplus(config)#exit
awplus#show snmp-server

SNMP Server ..... Enabled
IP Protocol ..... IPv4
SNMPv3 Engine ID (configured name) ... Not set
SNMPv3 Engine ID (actual) ..... 0x80001f888029af52e149198483
```

Related commands

- [show snmp-server](#)
- [snmp-server engineID local reset](#)
- [snmp-server group](#)

snmp-server engineID local reset

Overview Use this command to force the device to generate a new pseudo-random SNMPv3 engine ID by resetting the SNMPv3 engine. If the current engine ID is user defined, use the [snmp-server engineID local](#) command to set SNMPv3 engine ID to a system generated value.

Syntax `snmp-server engineID local reset`

Mode Global Configuration

Example To force the SNMPv3 engine ID to be reset to a system generated value, use the commands:

```
awplus# configure terminal
awplus(config)# snmp-server engineID local reset
```

Related commands [snmp-server engineID local](#)
[show snmp-server](#)

snmp-server group

Overview This command is used with SNMP version 3 only, and adds an SNMP group, optionally setting the security level and view access modes for the group. The security and access views defined for the group represent the minimum required of its users in order to gain access.

The **no** variant of this command deletes an SNMP group, and is used with SNMPv3 only. The group with the specified authentication/encryption parameters must already exist.

Syntax `snmp-server group <groupname> {auth|noauth|priv} [read <readname>|write <writename>|notify <notifyname>]`
`no snmp-server group <groupname>`

Parameter	Description
<groupname>	Group name. The group name is a string up to 20 characters long and is case sensitive.
auth	Authentication.
noauth	No authentication and no encryption.
priv	Authentication and encryption.
read	Configure read view.
<readname>	Read view name.
write	Configure write view.
<writename>	Write view name. The view name is a string up to 20 characters long and is case sensitive.
notify	Configure notify view.
<notifyname>	Notify view name. The view name is a string up to 20 characters long and is case sensitive.

Mode Global Configuration

Examples To add SNMP group, for ordinary users, use the following commands:

```
awplus# configure terminal
awplus(config)# snmp-server group usergroup noauth read
useraccess write useraccess
```

To delete the SNMP group called 'usergroup', use the following commands:

```
awplus# configure terminal
awplus(config)# no snmp-server group usergroup
```

**Related
commands** `snmp-server`
`show snmp-server`
`show snmp-server group`
`show snmp-server user`

snmp-server host

Overview This command specifies an SNMP trap host destination to which Trap or Inform messages generated by the device are sent.

For SNMP version 1 and 2c you must specify the community name parameter. For SNMP version 3, specify the authentication/encryption parameters and the user name. If the version is not specified, the default is SNMP version 1. Inform messages can be sent instead of traps for SNMP version 2c and 3.

Use the **no** variant of this command to remove an SNMP trap host. The trap host must already exist.

The trap host is uniquely identified by:

- host IP address (IPv4 or IPv6),
- inform or trap messages,
- community name (SNMPv1 or SNMP v2c) or the authentication/encryption parameters and user name (SNMP v3).

Syntax

```
snmp-server host {<ipv4-address>|<ipv6-address>} [traps]
[version 1] <community-name>

snmp-server host {<ipv4-address>|<ipv6-address>}
[informs|traps] version 2c <community-name>

snmp-server host {<ipv4-address>|<ipv6-address>}
[informs|traps] version 3 {auth|noauth|priv} <user-name>

no snmp-server host {<ipv4-address>|<ipv6-address>} [traps]
[version 1] <community-name>

no snmp-server host {<ipv4-address>|<ipv6-address>}
[informs|traps] version 2c <community-name>

no snmp-server host {<ipv4-address>|<ipv6-address>}
[informs|traps] version 3 {auth|noauth|priv} <user-name>
```

Syntax (VRF-Lite)

```
snmp-server host {<ipv4-address>|<ipv6-address>} [vrf
<vrf-name>] [informs|traps] version 1|2c|3 {auth|noauth|priv}
<user-name> {<community-name>|<user-name>}

no snmp-server host {<ipv4-address>|<ipv6-address>} [vrf
<vrf-name>] [informs|traps] version 1|2c|3 {auth|noauth|priv}
<user-name> {<community-name>|<user-name>}
```

Parameter	Description
<ipv4-address>	IPv4 trap host address in the format A.B.C.D, for example, 192.0.2.2.
<ipv6-address>	IPv6 trap host address in the format x:x::x:x for example, 2001:db8::8a2e:7334.
vrf <vrf-name>	Specify the VRF instance to use. If you do not specify an instance it will use the global VRF.

Parameter	Description
informs	Send Inform messages to this host.
traps	Send Trap messages to this host (default).
version	SNMP version to use for notification messages. Default: version 1.
1	Use SNMPv1 (default).
2c	Use SNMPv2c.
3	Use SNMPv3.
auth	Authentication.
noauth	No authentication.
priv	Encryption.
<community-name>	The SNMPv1 or SNMPv2c community name.
<user-name>	SNMPv3 user name.

Mode Global Configuration

Examples To configure the device to send generated traps to the IPv4 host destination 192.0.2.5 with the SNMPv2c community name 'public', use the following commands:

```
awplus# configure terminal
awplus(config)# snmp-server host 192.0.2.5 version 2c public
```

To configure the device to send generated traps to the IPv6 host destination 2001:db8::8a2e:7334 with the SNMPv2c community name 'private', use the following commands:

```
awplus# configure terminal
awplus(config)# snmp-server host 2001:db8::8a2e:7334 version 2c
private
```

To remove a configured trap host of 192.0.2.5 with the SNMPv2c community name 'public', use the following commands:

```
awplus# configure terminal
awplus(config)# no snmp-server host 192.0.2.5 version 2c public
```

To configure the device to send generated traps to an IPv4 host destination 192.168.1.2 with the SNMPv2c community name 'public' and on a VRF named 'red', use the following commands:

```
awplus# configure terminal
awplus(config)# snmp-server host 192.0.1.2 vrf red version 2c
public
```

Related commands `snmp trap link-status`
`snmp-server enable trap`
`snmp-server view`

Command changes Version 5.5.2-1.1: **vrf** parameter added for products that support VRF

snmp-server legacy-ifadminstatus

Overview Use this command to set the ifAdminStatus to reflect the operational state of the interface, rather than the administrative state.

The **no** variant of this command sets the ifAdminStatus to reflect the administrative state of the interface.

Syntax `snmp-server legacy-ifadminstatus`
`no snmp-server legacy-ifadminstatus`

Default Legacy ifAdminStatus is turned off by default, so by default the SNMP ifAdminStatus reflects the administrative state of the interface.

Mode Global Configuration

Usage notes Note that if you enable Legacy ifAdminStatus, the ifAdminStatus will report a link's status as Down when the link has been blocked by a process such as loop protection.

Example To turn on Legacy ifAdminStatus, use the commands:

```
awplus# configure terminal
awplus(config)# snmp-server legacy-ifadminstatus
```

Related commands [show interface](#)

snmp-server location

Overview This command sets the location of the system. The location is:

- displayed in the output of the [show system](#) command
- stored in the MIB object sysLocation

The **no** variant of this command removes the configured location from the system.

Syntax `snmp-server location <location-name>`
`no snmp-server location`

Parameter	Description
<code><location-name></code>	The location of the system, from 0 to 255 characters long. Valid characters are any printable character and spaces.

Mode Global Configuration

Example To set the location to “server room 523”, use the following commands:

```
awplus# configure terminal
awplus(config)# snmp-server location server room 523
```

Related commands [show snmp-server](#)
[show system](#)
[snmp-server contact](#)

snmp-server source-interface

Overview Use this command to specify the originating interface for SNMP traps or informs. An interface specified by this command must already have an IP address assigned to it.

Use the **no** variant of this command to reset the interface to its default value (the originating egress interface).

Syntax `snmp-server source-interface {traps|informs} <interface-name>`
`no snmp-server source-interface {traps|informs}`

Parameter	Description
traps	SNMP traps.
informs	SNMP informs.
<interface-name>	Interface name (must already have an IP address assigned).

Default The originating egress interface of the traps and informs messages

Mode Global Configuration

Usage notes When an SNMP server sends an SNMP trap or inform message, the message carries the notification IP address of its originating interface. Use this command to assign this interface.

Example The following commands set vlan2 to be the interface whose IP address is used as the originating address in SNMP informs packets.

```
awplus# configure terminal
awplus(config)# snmp-server source-interface informs vlan2
```

The following commands reset the originating source interface for SNMP trap messages to be the default interface (the originating egress interface):

```
awplus# configure terminal
awplus(config)# no snmp-server source-interface traps
```

Validation Commands `show running-config`

snmp-server startup-trap-delay

Overview Use this command to set the time in seconds after following completion of the device startup sequence before the device sends any SNMP traps (or SNMP notifications).

Use the no variant of this command to restore the default startup delay of 30 seconds.

Syntax `snmp-server startup-trap-delay <delay-time>`
`no snmp-server startup-trap-delay`

Parameter	Description
<code><delay-time></code>	Specify an SNMP trap delay time in seconds in the range of 30 to 600 seconds.

Default The SNMP server trap delay time is 30 seconds. The no variant restores the default.

Mode Global Configuration

Example To delay the device sending SNMP traps until 60 seconds after device startup, use the following commands:

```
awplus# configure terminal
awplus(config)# snmp-server startup-trap-delay 60
```

To restore the sending of SNMP traps to the default of 30 seconds after device startup, use the following commands:

```
awplus# configure terminal
awplus(config)# no snmp-server startup-trap-delay
```

Validation Commands `show snmp-server`

snmp-server user

Overview Use this command to create or move users as members of specified groups. This command is used with SNMPv3 only.

The **no** variant of this command removes an SNMPv3 user. The specified user must already exist.

Syntax `snmp-server user <username> <groupname> [encrypted] [auth {md5|sha} <auth-password>] [priv {des|aes} <privacy-password>]`
`no snmp-server user <username>`

Parameter	Description
<username>	User name. The user name is a string up to 20 characters long and is case sensitive.
<groupname>	Group name. The group name is a string up to 20 characters long and is case sensitive.
encrypted	Use the encrypted parameter when you want to enter encrypted passwords.
auth	Authentication protocol.
md5	MD5 Message Digest Algorithms.
sha	SHA Secure Hash Algorithm.
<auth-password>	Authentication password. The password is a string of 8 to 20 characters long and is case sensitive.
priv	Privacy protocol.
des	DES: Data Encryption Standard.
aes	AES: Advanced Encryption Standards.
<privacy-password>	Privacy password. The password is a string of 8 to 20 characters long and is case sensitive.

Mode Global Configuration

Usage notes Additionally this command provides the option of selecting an authentication protocol and (where appropriate) an associated password. Similarly, options are offered for selecting a privacy protocol and password.

- Note that each SNMP user must be configured on both the manager and agent entities. Where passwords are used, these passwords must be the same for both entities.
- Use the **encrypted** parameter when you want to enter already encrypted passwords in encrypted form as displayed in the running and startup configs stored on the device. For example, you may need to move a user from one group to another group and keep the same passwords for the user instead of removing the user to apply new passwords.

- User passwords are entered using plaintext without the **encrypted** parameter and are encrypted according to the authentication and privacy protocols selected.
- User passwords are viewed as encrypted passwords in running and startup configs shown from **show running-config** and **show startup-config** commands respectively. Copy and paste encrypted passwords from running-configs or startup-configs to avoid entry errors.

Examples To add SNMP user authuser as a member of group 'usergroup', with authentication protocol MD5, authentication password 'Authpass', privacy protocol AES and privacy password 'Privpass' use the following commands:

```
awplus# configure terminal
awplus(config)# snmp-server user authuser usergroup auth md5
Authpass priv aes Privpass
```

Validate the user is assigned to the group using the **show snmp-server user** command:

```
awplus#show snmp-server user
Name                Group name          Auth                Privacy
-----            -
authuser            usergroup           md5                 aes
```

To enter existing SNMP user 'authuser' with existing passwords as a member of group 'newusergroup' with authentication protocol MD5 with the encrypted authentication password 0x1c74b9c22118291b0ce0cd883f8dab6b74, and privacy protocol AES with the encrypted privacy password 0x0e0133db5453ebd03822b004eeacb6608f, use the following commands:

```
awplus# configure terminal
awplus(config)# snmp-server user authuser newusergroup
encrypted auth md5 0x1c74b9c22118291b0ce0cd883f8dab6b74 priv
aes 0x0e0133db5453ebd03822b004eeacb6608f
```

NOTE: Copy and paste the encrypted passwords from the **running-config** or the **startup-config** displayed, using the **show running-config** and **show startup-config** commands respectively, into the command line to avoid key stroke errors issuing this command.

Validate the user has been moved from the first group using the **show snmp-server user** command:

```
awplus#show snmp-server user
Name                Group name          Auth                Privacy
-----            -
authuser            newusergroup       md5                 aes
```

To delete SNMP user 'authuser', use the following commands:

```
awplus# configure terminal
awplus(config)# no snmp-server user authuser
```

**Related
commands** [show snmp-server user](#)
[snmp-server view](#)

snmp-server view

Overview Use this command to create an SNMP view that specifies a sub-tree of the MIB. Further sub-trees can then be added by specifying a new OID to an existing view. Views can be used in SNMP communities or groups to control the remote manager's access.

NOTE: The object identifier must be specified in a sequence of integers separated by decimal points.

The **no** variant of this command removes the specified view on the device. The view must already exist.

Syntax `snmp-server view <view-name> <mib-name> {included|excluded}`
`no snmp-server view <view-name>`

Parameter	Description
<view-name>	SNMP server view name. The view name is a string up to 20 characters long and is case sensitive.
<mib-name>	Object identifier of the MIB.
included	Include this OID in the view.
excluded	Exclude this OID in the view.

Mode Global Configuration

Examples The following command creates a view called "loc" that includes the system location MIB sub-tree.

```
awplus(config)# snmp-server view loc 1.3.6.1.2.1.1.6.0 included
```

To remove the view "loc" use the following command

```
awplus(config)# no snmp-server view loc
```

Related commands [show snmp-server view](#)
[snmp-server community](#)

undebug snmp

Overview This command applies the functionality of the no `debug snmp` command.

58

LLDP Commands

Introduction

Overview LLDP and LLDP-MED can be configured using the commands in this chapter, or by using SNMP with the LLDP-MIB and LLDP-EXT-DOT1-MIB (see the [Support for Allied Telesis Enterprise MIBs in AlliedWare Plus](#)).

The Voice VLAN feature can be configured using commands in [VLAN Commands](#) chapter.

For more information about LLDP, see the [LLDP Feature Overview and Configuration Guide](#).

LLDP can transmit a lot of data about the network. Typically, the network information gathered using LLDP is transferred to a Network Management System by SNMP. For security reasons, we recommend using SNMPv3 for this purpose (see the [SNMP Feature Overview and Configuration Guide](#)).

LLDP operates over physical ports only. For example, it can be configured on switch ports that belong to static or dynamic channel groups, but not on the channel groups themselves.

- Command List**
- [“clear lldp statistics”](#) on page 3263
 - [“clear lldp table”](#) on page 3264
 - [“debug lldp”](#) on page 3265
 - [“lldp faststart-count”](#) on page 3266
 - [“lldp holdtime-multiplier”](#) on page 3267
 - [“lldp management-address”](#) on page 3268
 - [“lldp med-notifications”](#) on page 3269
 - [“lldp med-tlv-select”](#) on page 3270
 - [“lldp non-strict-med-tlv-order-check”](#) on page 3273
 - [“lldp notification-interval”](#) on page 3274
 - [“lldp notifications”](#) on page 3275

- ["lldp port-number-type"](#) on page 3276
- ["lldp reinit"](#) on page 3277
- ["lldp run"](#) on page 3278
- ["lldp timer"](#) on page 3279
- ["lldp tlv-select"](#) on page 3280
- ["lldp transmit receive"](#) on page 3282
- ["lldp tx-delay"](#) on page 3283
- ["location civic-location configuration"](#) on page 3284
- ["location civic-location identifier"](#) on page 3288
- ["location civic-location id"](#) on page 3289
- ["location coord-location configuration"](#) on page 3290
- ["location coord-location identifier"](#) on page 3292
- ["location coord-location id"](#) on page 3293
- ["location elin-location"](#) on page 3295
- ["location elin-location id"](#) on page 3296
- ["show debugging lldp"](#) on page 3297
- ["show lldp"](#) on page 3298
- ["show lldp interface"](#) on page 3300
- ["show lldp local-info"](#) on page 3302
- ["show lldp neighbors"](#) on page 3307
- ["show lldp neighbors detail"](#) on page 3308
- ["show lldp statistics"](#) on page 3312
- ["show lldp statistics interface"](#) on page 3314
- ["show location"](#) on page 3316

clear lldp statistics

Overview This command clears all LLDP statistics (packet and event counters) associated with specified ports. If no port list is supplied, LLDP statistics for all ports are cleared.

Syntax `clear lldp statistics [interface <port-list>]`

Parameter	Description
<port-list>	The ports for which the statistics are to be cleared.

Mode Privileged Exec

Examples To clear all LLDP statistics for all ports, use the command:

```
awplus# clear lldp statistics
```

Related commands [show lldp statistics](#)
[show lldp statistics interface](#)

Command changes Version 5.4.8-2.1: Command added to AR2050V, AR3050S, AR4050S

clear lldp table

Overview This command clears the table of LLDP information received from neighbors through specified ports. If no port list is supplied, neighbor information is cleared for all ports.

Syntax `clear lldp table [interface <port-list>]`

Parameter	Description
<code><port-list></code>	The ports for which the neighbor information table is to be cleared.

Mode Privileged Exec

Examples To clear the entire table of neighbor information received through all ports, use the command:

```
awplus# clear lldp table
```

Related commands [show lldp neighbors](#)

debug lldp

Overview This command enables specific LLDP debug for specified ports. When LLDP debugging is enabled, diagnostic messages are entered into the system log. If no port list is supplied, the specified debugging is enabled for all ports.

The **no** variant of this command disables specific LLDP debug for specified ports. If no port list is supplied, the specified debugging is disabled for all ports.

Syntax debug lldp {[rx][rxpkt][tx][txpkt]} [interface [<port-list>]]
debug lldp operation
no debug lldp {[rx][rxpkt][tx][txpkt]} [interface [<port-list>]]
no debug lldp operation
no debug lldp all

Parameter	Description
rx	LLDP receive debug.
rxpkt	Raw LLDPDUs received in hex format.
tx	LLDP transmit debug.
txpkt	Raw Tx LLDPDUs transmitted in hex format.
<port-list>	The ports for which debug is to be configured.
operation	Debug for LLDP internal operation on the switch.
all	Disables all LLDP debugging for all ports.

Default By default no debug is enabled for any ports.

Mode Privileged Exec

Examples To enable debugging of LLDP transmit with packet dump on all ports, use the command:

```
awplus# debug lldp tx txpkt
```

To turn off all LLDP debugging on all ports, use the command:

```
awplus# no debug lldp all
```

Related commands [show debugging lldp](#)
[show running-config lldp](#)
[terminal monitor](#)

lldp faststart-count

Overview Use this command to set the fast start count for LLDP-MED. The fast start count determines how many fast start advertisements LLDP sends from a port when it starts sending LLDP-MED advertisements from the port, for instance, when it detects a new LLDP-MED capable device.

The **no** variant of this command resets the LLDP-MED fast start count to the default (3).

Syntax `lldp faststart-count <1-10>`
`no lldp faststart-count`

Parameter	Description
<1-10>	The number of fast start advertisements to send.

Default The default fast start count is 3.

Mode Global Configuration

Examples To set the fast start count to 5, use the command:

```
awplus# configure terminal
awplus(config)# lldp faststart-count 5
```

To reset the fast start count to the default setting (3), use the command:

```
awplus# configure terminal
awplus(config)# no lldp faststart-count
```

Related commands [show lldp](#)

Ildp holdtime-multiplier

Overview This command sets the holdtime multiplier value. The transmit interval is multiplied by the holdtime multiplier to give the Time To Live (TTL) value that is advertised to neighbors.

The **no** variant of this command sets the multiplier back to its default.

Syntax `lldp holdtime-multiplier <2-10>`
`no lldp holdtime-multiplier`

Parameter	Description
<2-10>	The multiplier factor.

Default The default holdtime multiplier value is 4.

Mode Global Configuration

Usage The Time-To-Live defines the period for which the information advertised to the neighbor is valid. If the Time-To-Live expires before the neighbor receives another update of the information, then the neighbor discards the information from its database.

Examples To set the holdtime multiplier to 2, use the commands:

```
awplus# configure terminal
awplus(config)# lldp holdtime-multiplier 2
```

To set the holdtime multiplier back to its default, use the commands:

```
awplus# configure terminal
awplus(config)# no lldp holdtime-multiplier 2
```

Related commands [show lldp](#)

lldp management-address

Overview This command sets the IPv4 address to be advertised to neighbors (in the Management Address TLV) via the specified ports. This address will override the default address for these ports.

The **no** variant of this command clears the user-configured management IP address advertised to neighbors via the specified ports. The advertised address reverts to the default.

Syntax `lldp management-address <ipaddr>`
`no lldp management-address`

Parameter	Description
<code><ipaddr></code>	The IPv4 address to be advertised to neighbors, in dotted decimal format. This must be one of the IP addresses already configured on the device.

Default The local loopback interface primary IPv4 address if set, else the primary IPv4 interface address of the lowest numbered VLAN the port belongs to, else the MAC address of the device's baseboard if no VLAN IP addresses are configured for the port.

Mode Interface Configuration

Usage notes To see the management address that will be advertised, use the [show lldp interface](#) command or [show lldp local-info](#) command.

Examples To set the management address advertised by port1.0.1 and port1.0.2, to be 192.168.1.6, use the commands:

```
awplus# configure terminal
awplus(config)# interface port1.0.1,port1.0.2
awplus(config-if)# lldp management-address 192.168.1.6
```

To clear the user-configured management address advertised by port1.0.1 and port1.0.2, and revert to using the default address, use the commands:

```
awplus# configure terminal
awplus(config)# interface port1.0.1,port1.0.2
awplus(config-if)# no lldp management-address
```

Related commands [show lldp interface](#)
[show lldp local-info](#)

Command changes Version 5.4.8-2.1: Command added to AR2050V, AR3050S, AR4050S

lldp med-notifications

Overview Use this command to enable LLDP to send LLDP-MED Topology Change Detected SNMP notifications relating to the specified ports. The switch sends an SNMP event notification when a new LLDP-MED compliant IP Telephony device is connected to or disconnected from a port on the switch.

Use the **no** variant of this command to disable the sending of LLDP-MED Topology Change Detected notifications relating to the specified ports.

Syntax `lldp med-notifications`
`no lldp med-notifications`

Default The sending of LLDP-MED notifications is disabled by default.

Mode Interface Configuration

Examples To enable the sending of LLDP-MED Topology Change Detected notifications relating to ports port1.0.1 and port1.0.2, use the commands:

```
awplus# configure terminal
awplus(config)# interface port1.0.1,port1.0.2
awplus(config-if)# lldp med-notifications
```

To disable the sending of LLDP-MED notifications relating to port1.0.1 and port1.0.2, use the commands:

```
awplus# configure terminal
awplus(config)# interface port1.0.1,port1.0.2
awplus(config-if)# no lldp med-notifications
```

Related commands [lldp notification-interval](#)
[lldp notifications](#)
[snmp-server enable trap](#)
[show lldp interface](#)

Command changes Version 5.4.8-2.1: Command added to AR2050V, AR3050S, AR4050S

lldp med-tlv-select

Overview Use this command to enable LLDP-MED Organizationally Specific TLVs for transmission in LLDP advertisements via the specified ports. The LLDP-MED Capabilities TLV must be enabled before any of the other LLDP-MED Organizationally Specific TLVs are enabled.

Use the **no** variant of this command to disable the specified LLDP-MED Organizationally Specific TLVs for transmission in LLDP advertisements via these ports. In order to disable the LLDP-MED Capabilities TLV, you must also disable the rest of these TLVs. Disabling all these TLVs disables LLDP-MED advertisements.

Syntax

```
lldp med-tlv-select [capabilities] [network-policy] [location]
[inventory-management]

lldp med-tlv-select all

no lldp med-tlv-select [capabilities] [network-policy]
[location] [inventory-management]

no lldp med-tlv-select all
```

Parameter	Description
capabilities	LLDP-MED Capabilities TLV. When this is enabled, the MAC/PHY Configuration/Status TLV from IEEE 802.3 Organizationally Specific TLVs is also automatically included in LLDP-MED advertisements, whether or not it has been explicitly enabled by the <code>lldp tlv-select</code> command.
network-policy	Network Policy TLV. This TLV is transmitted if Voice VLAN parameters have been configured using the commands: <ul style="list-style-type: none"><code>switchport voice dscp</code><code>switchport voice vlan</code><code>switchport voice vlan priority</code>
location	Location Identification TLV. This TLV is transmitted if location information has been configured using the commands: <ul style="list-style-type: none"><code>location elin-location-id</code><code>location civic-location identifier</code><code>location civic-location configuration</code><code>location coord-location identifier</code><code>location coord-location configuration</code><code>location elin-location</code>

Parameter	Description
inventory-management	Inventory Management TLV Set, including the following TLVs: <ul style="list-style-type: none"> • Hardware Revision • Firmware Revision • Software Revision • Serial Number • Manufacturer Name • Model Name • Asset ID
all	All LLDP-MED Organizationally Specific TLVs.

Default By default LLDP-MED Capabilities, Network Policy, Location Identification and Extended Power-via-MDI TLVs are enabled. Therefore, if LLDP is enabled using the `lldp run` command, by default LLDP-MED advertisements are transmitted on ports that detect LLDP-MED neighbors connected to them.

Mode Interface Configuration

Usage notes LLDP-MED TLVs are only sent in advertisements via a port if there is an LLDP-MED-capable device connected to it. To see whether there are LLDP-MED capable devices connected to the ports, use the `show lldp neighbors` command.

Examples To enable inclusion of the Inventory TLV Set in advertisements transmitted via port1.0.1 and port1.0.2, use the commands:

```
awplus# configure terminal
awplus(config)# interface port1.0.1,port1.0.2
awplus(config-if)# lldp med-tlv-select inventory-management
```

To exclude the Inventory TLV Set in advertisements transmitted via port1.0.1 and port1.0.2, use the commands:

```
awplus# configure terminal
awplus(config)# interface port1.0.1,port1.0.2
awplus(config-if)# no lldp med-tlv-select inventory-management
```

To disable LLDP-MED advertisements transmitted via port1.0.1 and port1.0.2, disable all these TLVs using the commands:

```
awplus# configure terminal
awplus(config)# interface port1.0.1,port1.0.2
awplus(config-if)# no lldp med-tlv-select all
```

Related commands

- lldp tlv-select
- location elin-location-id
- location civic-location identifier
- location civic-location configuration
- location coord-location identifier
- location coord-location configuration
- location elin-location
- show lldp interface
- switchport voice dscp
- switchport voice vlan
- switchport voice vlan priority

Command changes Version 5.4.8-2.1: Command added to AR2050V, AR3050S, AR4050S

lldp non-strict-med-tlv-order-check

Overview Use this command to enable non-strict order checking for LLDP-MED advertisements it receives. That is, use this command to enable LLDP to receive and store TLVs from LLDP-MED advertisements even if they do not use standard TLV order.

Use the **no** variant of this command to disable non-strict order checking for LLDP-MED advertisements, that is, to set strict TLV order checking, so that LLDP discards any LLDP-MED TLVs that occur before the LLDP-MED Capabilities TLV in an advertisement.

Syntax `lldp non-strict-med-tlv-order-check`
`no lldp non-strict-med-tlv-order-check`

Default By default TLV non-strict order checking for LLDP-MED advertisements is disabled. That is, strict order checking is applied to LLDP-MED advertisements, according to ANSI/TIA-1057, and LLDP-MED TLVs in non-standard order are discarded.

Mode Global Configuration

Usage notes The ANSI/TIA-1057 specifies standard order for TLVs in LLDP-MED advertisements, and specifies that if LLDP receives LLDP advertisements with non-standard LLDP-MED TLV order, the TLVs in non-standard order should be discarded. This implementation of LLDP-MED follows the standard: it transmits TLVs in the standard order, and by default discards LLDP-MED TLVs that occur before the LLDP-MED Capabilities TLV in an advertisement. However, some implementations of LLDP transmit LLDP-MED advertisements with non-standard TLV order. To receive and store the data from these non-standard advertisements, enable non-strict order checking for LLDP-MED advertisements using this command.

Examples To enable strict TLV order checking, use the commands:

```
awplus# configure terminal
awplus(config)# lldp tlv-order-check
```

To disable strict TLV order checking, use the commands:

```
awplus# configure terminal
awplus(config)# no lldp tlv-order-check
```

Related commands [show running-config lldp](#)

lldp notification-interval

Overview This command sets the notification interval. This is the minimum interval between LLDP SNMP notifications (traps) of each kind (LLDP Remote Tables Change Notification and LLDP-MED Topology Change Notification).

The **no** variant of this command sets the notification interval back to its default.

Syntax `lldp notification-interval <5-3600>`
`no lldp notification-interval`

Parameter	Description
<5-3600>	The interval in seconds.

Default The default notification interval is 5 seconds.

Mode Global Configuration

Examples To set the notification interval to 20 seconds, use the commands:

```
awplus# configure terminal
awplus(config)# lldp notification-interval 20
```

To set the notification interval back to its default, use the commands:

```
awplus# configure terminal
awplus(config)# no lldp notification-interval
```

Related commands [lldp notifications](#)
[show lldp](#)

Ildp notifications

Overview This command enables the sending of LLDP SNMP notifications (traps) relating to specified ports.

The **no** variant of this command disables the sending of LLDP SNMP notifications for specified ports.

Syntax `lldp notifications`
`no lldp notifications`

Default The sending of LLDP SNMP notifications is disabled by default.

Mode Interface Configuration

Examples

Related commands `lldp notification-interval`
`show lldp interface`
`snmp-server enable trap`

lldp port-number-type

Overview This command sets the type of port identifier used to enumerate, that is to count, the LLDP MIB local port entries. The LLDP MIB (IEEE Standard 802.1AB-2005, Section 12, LLDP MIB Definitions.) requires the port number value to count LLDP local port entries.

This command also enables you to optionally set an interface index to enumerate the LLDP MIB local port entries, if required by your management system.

The **no** variant of this command resets the type of port identifier back to the default setting (number).

Syntax `lldp port-number-type [number|ifindex]`
`no lldp port-number-type`

Parameter	Description
number	Set the type of port identifier to a port number to enumerate the LLDP MIB local port entries.
ifindex	Set the type of port identifier to an interface index to enumerate the LLDP MIB local port entries.

Default The default port identifier type is number. The no variant of this command sets the port identifier type to the default.

Mode Global Configuration

Examples To set the type of port identifier used to enumerate LLDP MIB local port entries to port numbers, use the commands:

```
awplus# configure terminal
awplus(config)# lldp port-number-type number
```

To set the type of port identifier used to enumerate LLDP MIB local port entries to interface indexes, use the commands:

```
awplus# configure terminal
awplus(config)# lldp port-number-type ifindex
```

To reset the type of port identifier used to enumerate LLDP MIB local port entries the default (port numbers), use the commands:

```
awplus# configure terminal
awplus(config)# no lldp port-number-type
```

Related commands [show lldp](#)

Ildp reinit

Overview This command sets the value of the reinitialization delay. This is the minimum time after disabling LLDP on a port before it can reinitialize.

The **no** variant of this command sets the reinitialization delay back to its default setting.

Syntax `lldp reinit <1-10>`
`no lldp reinit`

Parameter	Description
<1-10>	The delay in seconds.

Default The default reinitialization delay is 2 seconds.

Mode Global Configuration

Examples To set the reinitialization delay to 3 seconds, use the commands:

```
awplus# configure terminal
awplus(config)# lldp reinit 3
```

To set the reinitialization delay back to its default, use the commands:

```
awplus# configure terminal
awplus(config)# no lldp reinit
```

Related commands [show lldp](#)

lldp run

Overview This command enables the operation of LLDP on the device.
The **no** variant of this command disables the operation of LLDP on the device. The LLDP configuration remains unchanged.

Syntax lldp run
no lldp run

Default LLDP is disabled by default.

Mode Global Configuration

Examples To enable LLDP operation, use the commands:

```
awplus# configure terminal  
awplus(config)# lldp run
```

To disable LLDP operation, use the commands:

```
awplus# configure terminal  
awplus(config)# no lldp run
```

Related commands [show lldp](#)

Ildp timer

Overview This command sets the value of the transmit interval. This is the interval between regular transmissions of LLDP advertisements.

The **no** variant of this command sets the transmit interval back to its default.

Syntax `lldp timer <5-32768>`
`no lldp timer`

Parameter	Description
<code><5-32768></code>	The transmit interval in seconds. The transmit interval must be at least four times the transmission delay timer (lldp tx-delay command).

Default The default transmit interval is 30 seconds.

Mode Global Configuration

Examples To set the transmit interval to 90 seconds, use the commands:

```
awplus# configure terminal
awplus(config)# lldp timer 90
```

To set the transmit interval back to its default, use the commands:

```
awplus# configure terminal
awplus(config)# no lldp timer
```

Related commands [lldp tx-delay](#)
[show lldp](#)

lldp tlv-select

Overview This command enables one or more optional TLVs, or all TLVs, for transmission in LLDP advertisements via the specified ports. The TLVs can be specified in any order; they are placed in LLDP frames in a fixed order (as described in IEEE 802.1AB). The mandatory TLVs (Chassis ID, Port ID, Time To Live, End of LLDPDU) are always included in LLDP advertisements.

In LLDP-MED advertisements the MAC/PHY Configuration/Status TLV will be always be included regardless of whether it is selected by this command.

The **no** variant of this command disables the specified optional TLVs, or all optional TLVs, for transmission in LLDP advertisements via the specified ports.

Syntax

```
lldp tlv-select { [<tlv>]... }
lldp tlv-select all
no lldp tlv-select { [<tlv>]... }
no lldp tlv-select all
```

Parameter	Description
<tlv>	The TLV to transmit in LLDP advertisements. One of these keywords: <ul style="list-style-type: none"> port-description (specified by the description (interface) command) system-name (specified by the hostname command) system-description system-capabilities management-address port-vlan port-and-protocol-vlans vlan-names protocol-ids mac-phy-config power-management (Power Via MDI TLV) link-aggregation max-frame-size
all	All TLVs.

Default By default no optional TLVs are included in LLDP advertisements. The MAC/PHY Configuration/Status TLV (**mac-phy-config**) is included in LLDP-MED advertisements whether or not it is selected by this command.

Mode Interface Configuration

Examples

Related commands

- description (interface)
- hostname
- lldp med-tlv-select
- show lldp interface
- show lldp local-info

Ildp transmit receive

Overview This command enables transmission and/or reception of LLDP advertisements to or from neighbors through the specified ports.

The **no** variant of this command disables transmission and/or reception of LLDP advertisements through specified ports.

Syntax `lldp {[transmit] [receive]}`
`no lldp {[transmit] [receive]}`

Parameter	Description
transmit	Enable or disable transmission of LLDP advertisements via this port or ports.
receive	Enable or disable reception of LLDP advertisements via this port or ports.

Default LLDP advertisement transmission and reception are enabled on all ports by default.

Mode Interface Configuration

Examples To enable transmission of LLDP advertisements on port1.0.1 and port1.0.2, use the commands:

```
awplus# configure terminal
awplus(config)# interface port1.0.1,port1.0.2
awplus(config-if)# lldp transmit
```

To enable LLDP advertisement transmission and reception on port1.0.1 and port1.0.2, use the commands:

```
awplus# configure terminal
awplus(config)# interface port1.0.1,port1.0.2
awplus(config-if)# lldp transmit receive
```

To disable LLDP advertisement transmission and reception on port1.0.1 and port1.0.2, use the commands:

```
awplus# configure terminal
awplus(config)# interface port1.0.1,port1.0.2
awplus(config-if)# no lldp transmit receive
```

Related commands [show lldp interface](#)

Command changes Version 5.4.8-2.1: Command added to AR2050V, AR3050S, AR4050S

lldp tx-delay

Overview This command sets the value of the transmission delay timer. This is the minimum time interval between transmitting LLDP advertisements due to a change in LLDP local information.

The **no** variant of this command sets the transmission delay timer back to its default setting.

Syntax `lldp tx-delay <1-8192>`
`no lldp tx-delay`

Parameter	Description
<code><1-8192></code>	The transmission delay in seconds. The transmission delay cannot be greater than a quarter of the transmit interval (lldp timer command).

Default The default transmission delay timer is 2 seconds.

Mode Global Configuration

Examples To set the transmission delay timer to 12 seconds, use the commands:

```
awplus# configure terminal
awplus(config)# lldp tx-delay 12
```

To set the transmission delay timer back to its default, use the commands:

```
awplus# configure terminal
awplus(config)# no lldp tx-delay
```

Related commands [lldp timer](#)
[show lldp](#)

location civic-location configuration

Overview Use these commands to configure a civic address location. The country parameter must be specified first, and at least one of the other parameters must be configured before the location can be assigned to a port.

Use the **no** variants of this command to delete civic address parameters from the location.

Syntax

```
country <country>
state <state>
no state
county <county>
no county
city <city>
no city
division <division>
no division
neighborhood <neighborhood>
no neighborhood
street-group <street-group>
no street-group
leading-street-direction <leading-street-direction>
no leading-street-direction
trailing-street-suffix <trailing-street-suffix>
no trailing-street-suffix
street-suffix <street-suffix>
no street-suffix
house-number <house-number>
no house-number
house-number-suffix <house-number-suffix>
no house-number-suffix
landmark <landmark>
no landmark
additional-information <additional-information>
no additional-information
```

Syntax (cont.) name <name>
no name
postalcode <postalcode>
no postalcode
building <building>
no building
unit <unit>
no unit
floor <floor>
no floor
room <room>
no room
place-type <place-type>
no place-type
postal-community-name <postal-community-name>
no postal-community-name
post-office-box <post-office-box>
no post-office-box
additional-code <additional-code>
no additional-code
seat <seat>
no seat
primary-road-name <primary-road-name>
no primary-road-name
road-section <road-section>
no road-section
branch-road-name <branch-road-name>
no branch-road-name
sub-branch-road-name <sub-branch-road-name>
no sub-branch-road-name
street-name-pre-modifier <street-name-pre-modifier>
no street-name-pre-modifier
streetname-post-modifier <streetname-post-modifier>
no streetname-post-modifier

Parameter	Description
<country>	Upper-case two-letter country code, as specified in ISO 3166.
<state>	State (Civic Address (CA) Type 1): national subdivisions (state, canton, region).
<county>	County (CA Type 2): County, parish, gun (JP), district (IN).
<city>	City (CA Type 3): city, township, shi (JP).
<division>	City division (CA Type 4): City division, borough, city district, ward, chou (JP).
<neighborhood>	Neighborhood (CA Type 5): neighborhood, block.
<street-group>	Street group (CA Type 6): group of streets below the neighborhood level.
<leading-street-direction>	Leading street direction (CA Type 16).
<trailing-street-suffix>	Trailing street suffix (CA Type 17).
<street-suffix>	Street suffix (CA Type 18): street suffix or type.
<house-number>	House number (CA Type 19).
<house-number-suffix>	House number suffix (CA Type 20).
<landmark>	Landmark or vanity address (CA Type 21).
<additional-information>	Additional location information (CA Type 22).
<name>	Name (CA Type 23): residence and office occupant.
<postal-code>	Postal/zip code (CA Type 24).
<building>	Building (CA Type 25): structure.
<unit>	Unit (CA Type 26): apartment, suite.
<floor>	Floor (CA Type 27).
<room>	Room (CA Type 28).
<place-type>	Type of place (CA Type 29).
<postal-community-name>	Postal community name (CA Type 30).
<post-office-box>	Post office box (P.O. Box) (CA Type 31).
<additional-code>	Additional code (CA Type 32).
<seat>	Seat (CA Type 33): seat (desk, cubicle, workstation).
<primary-road-name>	Primary road name (CA Type 34).
<road-section>	Road section (CA Type 35).

Parameter	Description
<code><branch-road-name></code>	Branch road name (CA Type 36).
<code><sub-branch-road-name></code>	Sub-branch road name (CA Type 37).
<code><street-name-pre-modifier></code>	Street name pre-modifier (CA Type 38).
<code><street-name-post-modifier></code>	Street name post-modifier (CA Type 39).

Default By default no civic address location information is configured.

Mode Civic Address Location Configuration

Usage notes The **country** parameter must be configured before any other parameters can be configured; this creates the location. The country parameter cannot be deleted. One or more of the other parameters must be configured before the location can be assigned to a port. The country parameter must be entered as an upper-case two-letter country code, as specified in ISO 3166. All other parameters are entered as alpha-numeric strings. Do not configure all the civic address parameters (this would generate TLVs that are too long). Configure a subset of these parameters—enough to consistently and precisely identify the location of the device. If the location is to be used for Emergency Call Service (ECS), the particular ECS application may have guidelines for configuring the civic address location. For more information about civic address format, see the [LLDP Feature Overview and Configuration Guide](#).

To specify the civic address location, use the [location civic-location identifier](#) command. To delete the civic address location, use the **no** variant of the **location civic-location identifier** command. To assign the civic address location to particular ports, so that it can be advertised in TLVs from those ports, use the command [location civic-location-id](#) command.

Examples To configure civic address location 1 with location "27 Nazareth Avenue, Christchurch, New Zealand" in civic-address format, use the commands:

```
awplus# configure terminal
awplus(config)# location civic-location identifier 1
awplus(config-civic)# country NZ
awplus(config-civic)# city Christchurch
awplus(config-civic)# primary-road-name Nazareth
awplus(config-civic)# street-suffix Avenue
awplus(config-civic)# house-number 27
```

Related commands

- [location civic-location-id](#)
- [location civic-location identifier](#)
- [show lldp local-info](#)
- [show location](#)

location civic-location identifier

Overview Use this command to enter the Civic Address Location Configuration mode to configure the specified location.

Use the **no** variant of this command to delete a civic address location. This also removes the location from any ports it has been assigned to.

Syntax `location civic-location identifier <civic-loc-id>`
`no location civic-location identifier <civic-loc-id>`

Parameter	Description
<code><civic-loc-id></code>	A unique civic address location ID, in the range 1 to 4095.

Default By default there are no civic address locations.

Mode Global Configuration

Usage notes To configure the location information for this civic address location identifier, use the [location civic-location configuration](#) command. To associate this civic location identifier with particular ports, use the [location elin-location-id](#) command.

Up to 400 locations can be configured on the switch for each type of location information, up to a total of 1200 locations.

Examples To enter Civic Address Location Configuration mode for the civic address location with ID 1, use the commands:

```
awplus# configure terminal
awplus(config)# location civic-location identifier 1
awplus(config-civic)#
```

To delete the civic address location with ID 1, use the commands:

```
awplus# configure terminal
awplus(config)# no location civic-location identifier 1
```

Related commands

- [location civic-location-id](#)
- [location civic-location configuration](#)
- [show location](#)
- [show running-config lldp](#)

location civic-location-id

Overview Use this command to assign a civic address location to the ports. The civic address location must already exist. This replaces any previous assignment of civic address location for the ports. Up to one location of each type can be assigned to a port.

Use the **no** variant of this command to remove a location identifier from the ports.

Syntax `location civic-location-id <civic-loc-id>`
`no location civic-location-id [<civic-loc-id>]`

Parameter	Description
<code><civic-loc-id></code>	Civic address location ID, in the range 1 to 4095.

Default By default no civic address location is assigned to ports.

Mode Interface Configuration

Usage notes The civic address location associated with a port can be transmitted in Location Identification TLVs via the port.

Before using this command, create the location using the following commands:

- [location civic-location identifier](#) command
- [location civic-location configuration](#) command

If a civic-address location is deleted using the **no** variant of the [location civic-location identifier](#) command, it is automatically removed from all ports.

Examples To assign the civic address location 1 to port1.0.1, use the commands:

```
awplus# configure terminal
awplus(config)# interface port1.0.1
awplus(config-if)# location civic-location-id 1
```

To remove a civic address location from port1.0.1, use the commands:

```
awplus# configure terminal
awplus(config)# interface port1.0.1
awplus(config-if)# no location civic-location-id
```

Related commands [lldp med-tlv-select](#)
[location civic-location identifier](#)
[location civic-location configuration](#)
[show location](#)

Command changes Version 5.4.8-2.1: Command added to AR2050V, AR3050S, AR4050S

location coord-location configuration

Overview Use this command to configure a coordinate-based location. All parameters must be configured before assigning this location identifier to a port.

Syntax

```
latitude <latitude>  
lat-resolution <lat-resolution>  
longitude <longitude>  
long-resolution <long-resolution>  
altitude <altitude> {meters|floor}  
alt-resolution <alt-resolution>  
datum {wgs84|nad83-navd|nad83-mllw}
```

Parameter	Description
<lat-resolution>	Latitude resolution, as a number of valid bits, in the range 0 to 34.
<latitude>	Latitude value in degrees in the range -90.0 to 90.0
<long-resolution>	Longitude resolution, as a number of valid bits, in the range 0 to 34.
<longitude>	Longitude value in degrees, in the range -180.0 to 180.0.
<alt-resolution>	Altitude resolution, as a number of valid bits, in the range 0 to 30. A resolution of 0 can be used to indicate an unknown value.
<altitude>	Altitude value, in meters or floors.
meters	The altitude value is in meters.
floors	The altitude value is in floors.
datum	The geodetic system (or datum) that the specified coordinate values are based on.
wgs84	World Geodetic System 1984.
nad83-navd	North American Datum 1983 - North American Vertical Datum.
nad83-mllw	North American Datum 1983 - Mean Lower Low Water vertical datum.

Default By default no coordinate location information is configured.

Mode Coordinate Configuration

Usage Latitude and longitude values are always stored internally, and advertised in the Location Identification TLV, as 34-bit fixed-point binary numbers, with a 25-bit fractional part, irrespective of the number of digits entered by the user. Likewise

altitude is stored as a 30-bit fixed point binary number, with an 8-bit fractional part. Because the user-entered decimal values are stored as fixed point binary numbers, they cannot always be represented exactly—the stored binary number is converted to a decimal number for display in the output of the [show location](#) command. For example, a user-entered latitude value of “2.77” degrees is displayed as “2.7699999809265136718750000”.

The **lat-resolution**, **long-resolution**, and **alt-resolution** parameters allow the user to specify the resolution of each coordinate element as the number of valid bits in the internally-stored binary representation of the value. These resolution values can be used by emergency services to define a search area.

To specify the coordinate identifier, use the [location coord-location identifier](#) command. To remove coordinate information, delete the coordinate location by using the **no** variant of that command. To associate the coordinate location with particular ports, so that it can be advertised in TLVs from those ports, use the [location elin-location-id](#) command.

Example To configure the location for the White House in Washington DC, which has the coordinates based on the WGS84 datum of 38.89868 degrees North (with 22 bit resolution), 77.03723 degrees West (with 22 bit resolution), and 15 meters height (with 9 bit resolution), use the commands:

```
awplus# configure terminal
awplus(config)# location coord-location identifier 1
awplus(config-coord)# la-resolution 22
awplus(config-coord)# latitude 38.89868
awplus(config-coord)# lo-resolution 22
awplus(config-coord)# longitude -77.03723
awplus(config-coord)# alt-resolution 9
awplus(config-coord)# altitude 15 meters
awplus(config-coord)# datum wgs84
```

Related commands

- [location coord-location-id](#)
- [location coord-location identifier](#)
- [show lldp local-info](#)
- [show location](#)

location coord-location identifier

Overview Use this command to enter Coordinate Location Configuration mode for this coordinate location.

Use the **no** variant of this command to delete a coordinate location. This also removes the location from any ports it has been assigned to.

Syntax `location coord-location identifier <coord-loc-id>`
`no location coord-location identifier <coord-loc-id>`

Parameter	Description
<code><coord-loc-id></code>	A unique coordinate location identifier, in the range 1 to 4095.

Default By default there are no coordinate locations.

Mode Global Configuration

Usage Up to 400 locations can be configured on the switch for each type of location information, up to a total of 1200 locations.

To configure this coordinate location, use the [location coord-location configuration](#) command. To associate this coordinate location with particular ports, so that it can be advertised in TLVs from those ports, use the [location coord-location-id](#) command.

Examples To enter Coordinate Location Configuration mode to configure the coordinate location with ID 1, use the commands:

```
awplus# configure terminal
awplus(config)# location coord-location identifier 1
awplus(config-coord)#
```

To delete coordinate location 1, use the commands:

```
awplus# configure terminal
awplus(config)# no location coord-location identifier 1
```

Related commands [location coord-location-id](#)
[location coord-location configuration](#)
[show lldp local-info](#)
[show location](#)

location coord-location-id

Overview Use this command to assign a coordinate location to the ports. The coordinate location must already exist. This replaces any previous assignment of coordinate location for the ports. Up to one location of each type can be assigned to a port.

Use the **no** variant of this command to remove a location from the ports.

Syntax `location coord-location-id <coord-loc-id>`
`no location coord-location-id [<coord-loc-id>]`

Parameter	Description
<code><coord-loc-id></code>	Coordinate location ID, in the range 1 to 4095.

Default By default no coordinate location is assigned to ports.

Mode Interface Configuration

Usage notes The coordinate location associated with a port can be transmitted in Location Identification TLVs via the port.

Before using this command, configure the location using the following commands:

- [location coord-location identifier](#) command
- [location coord-location configuration](#) command

If a coordinate location is deleted using the **no** variant of the [location coord-location identifier](#) command, it is automatically removed from all ports.

Examples To assign coordinate location 1 to port1.0.1, use the commands:

```
awplus# configure terminal
awplus(config)# interface port1.0.1
awplus(config-if)# location coord-location-id 1
```

To remove a coordinate location from port1.0.1, use the commands:

```
awplus# configure terminal
awplus(config)# interface port1.0.1
awplus(config-if)# no location coord-location-id
```

Related commands

- [lldp med-tlv-select](#)
- [location coord-location identifier](#)
- [location coord-location configuration](#)
- [show location](#)

Command changes Version 5.4.8-2.1: Command added to AR2050V, AR3050S, AR4050S

location elin-location

Overview Use this command to create or modify an ELIN location.

Use the **no** variant of this command to delete an ELIN location, and remove it from any ports it has been assigned to.

Syntax `location elin-location <elin> identifier <elin-loc-id>`
`no location elin-location identifier <elin-loc-id>`

Parameter	Description
<code><elin></code>	Emergency Location Identification Number (ELIN) for Emergency Call Service (ECS), in the range 10 to 25 digits long. In North America, ELINs are typically 10 digits long.
<code><elin-loc-id></code>	A unique ELIN location identifier, in the range 1 to 4095.

Default By default there are no ELIN location identifiers.

Mode Global Configuration

Usage Up to 400 locations can be configured on the switch for each type of location information, up to a total of 1200 locations.

To assign this ELIN location to particular ports, so that it can be advertised in TLVs from those ports, use the [location elin-location-id](#) command.

Examples To create a new ELIN location with ID 1, and configure it with ELIN "1234567890", use the commands:

```
awplus# configure terminal
awplus(config)# location elin-location 1234567890 identifier 1
```

To delete existing ELIN location with ID 1, use the commands:

```
awplus# configure terminal
awplus(config)# no location elin-location identifier 1
```

Related commands [location elin-location-id](#)
[show lldp local-info](#)
[show location](#)

location elin-location-id

Overview Use this command to assign an ELIN location to the ports. The ELIN location must already exist. This replaces any previous assignment of ELIN location for the ports. Up to one location of each type can be assigned to a port.

Use the **no** variant of this command to remove a location identifier from the ports.

Syntax `location elin-location-id <elin-loc-id>`
`no location elin-location-id [<elin-loc-id>]`

Parameter	Description
<code><elin-loc-id></code>	ELIN location identifier, in the range 1 to 4095.

Default By default no ELIN location is assigned to ports.

Mode Interface Configuration

Usage notes An ELIN location associated with a port can be transmitted in Location Identification TLVs via the port.

Before using this command, configure the location using the [location elin-location](#) command.

If an ELIN location is deleted using the **no** variant of one of the [location elin-location](#) command, it is automatically removed from all ports.

Examples To assign ELIN location 1 to port1.0.1, use the commands:

```
awplus# configure terminal
awplus(config)# interface port1.0.1
awplus(config-if)# location elin-location-id 1
```

To remove ELIN location 1 from port1.0.1, use the commands:

```
awplus# configure terminal
awplus(config)# interface port1.0.1
awplus(config-if)# no location elin-location-id 1
```

Related commands [lldp med-tlv-select](#)
[location elin-location](#)
[show location](#)

Command changes Version 5.4.8-2.1: Command added to AR2050V, AR3050S, AR4050S

show debugging lldp

Overview This command displays LLDP debug settings for specified ports. If no port list is supplied, LLDP debug settings for all ports are displayed.

Syntax `show debugging lldp [interface <port-list>]`

Parameter	Description
<port-list>	The ports for which the LLDP debug settings are shown.

Mode User Exec and Privileged Exec

Examples To display LLDP debug settings for all ports, use the command:

```
awplus# show debugging lldp
```

Output Figure 58-1: Example output from the **show debugging lldp** command

Table 1: Parameters in the output of the **show debugging lldp** command

Parameter	Description
Port	Port name.
Rx	Whether debugging of LLDP receive is enabled on the port.
RxPkt	Whether debugging of LLDP receive packet dump is enabled on the port.
Rx	Whether debugging of LLDP transmit is enabled on the port.
RxPkt	Whether debugging of LLDP transmit packet dump is enabled on the port.

Related commands [debug lldp](#)

show lldp

Overview This command displays LLDP status and global configuration settings.

Syntax show lldp

Mode User Exec and Privileged Exec

Example To display LLDP status and global configuration settings, use the command:

```
awplus# show lldp
```

Output

Table 2: Example output from the **show lldp** command

```
awplus# show lldp

LLDP Global Configuration:                [Default Values]
LLDP Status ..... Enabled                [Disabled]
Notification Interval ..... 5 secs       [5]
Tx Timer Interval ..... 30 secs          [30]
Hold-time Multiplier ..... 4             [4]
(Computed TTL value ..... 120 secs)
Reinitialization Delay .... 2 secs       [2]
Tx Delay ..... 2 secs                    [2]

Port Number Type..... Ifindex           [Port-Number]
Fast Start Count ..... 5                 [3]

LLDP Global Status:
Total Neighbor Count ..... 47
Neighbors table last updated 0 hrs 0 mins 43 secs ago
```

Table 3: Parameters in the output of the **show lldp** command

Parameter	Description
LLDP Status	Whether LLDP is enabled. Default is disabled.
Notification Interval	Minimum interval between LLDP notifications.
Tx Timer Interval	Transmit interval between regular transmissions of LLDP advertisements.
Hold-time Multiplier	The holdtime multiplier. The transmit interval is multiplied by the holdtime multiplier to give the Time To Live (TTL) value that is advertised to neighbors.
Reinitialization Delay	The reinitialization delay. This is the minimum time after disabling LLDP transmit on a port before it can reinitialize again.

Table 3: Parameters in the output of the **show lldp** command (cont.)

Parameter	Description
Tx Delay	The transmission delay. This is the minimum time interval between transmitting advertisements due to a change in LLDP local information.
Port Number Type	The type of port identifier used to enumerate LLDP MIB local port entries, as set by the lldp port-number-type command.
Fast Start Count	The number of times fast start advertisements are sent for LLDP-MED.
Total Neighbor Count	Number of LLDP neighbors discovered on all ports.
Neighbors table last updated	The time since the LLDP neighbor table was last updated.

Related commands [show lldp interface](#)
[show running-config lldp](#)

show lldp interface

Overview This command displays LLDP configuration settings for specified ports. If no port list is specified, LLDP configuration for all ports is displayed.

Syntax `show lldp interface [<port-list>]`

Parameter	Description
<port-list>	The ports for which the LLDP configuration settings are to be shown.

Mode User Exec and Privileged Exec

Examples To display LLDP configuration settings for all ports, use the command:

```
awplus# show lldp interface
```

Output Figure 58-2: Example output from the **show lldp interface** command

Table 4: Parameters in the output of the **show lldp interface** command

Parameter	Description
Port	Port name.
Rx	Whether reception of LLDP advertisements is enabled on the port.
Tx	Whether transmission of LLDP advertisements is enabled on the port.
Notif	Whether sending SNMP notification for LLDP is enabled on the port: <ul style="list-style-type: none">• RM = Remote Tables Change Notification• TP = LLDP-MED Topology Change Notification
Management Addr	Management address advertised to neighbors.
Base TLVs Enabled for Tx	List of optional Base TLVs enabled for transmission: <ul style="list-style-type: none">• Pd = Port Description• Sn =System Name• Sd = System Description• Sc =System Capabilities• Ma = Management Address

Table 4: Parameters in the output of the **show lldp interface** command (cont.)

Parameter	Description
802.1 TLVs Enabled for Tx	List of optional 802.1 TLVs enabled for transmission: <ul style="list-style-type: none">• Pv = Port VLAN ID• Pp = Port And Protocol VLAN ID• Vn = VLAN Name• Pi =Protocol Identity
802.3 TLVs Enabled for Tx	List of optional 802.3 TLVs enabled for transmission: <ul style="list-style-type: none">• Mp = MAC/PHY Configuration/Status• Po = Power Via MDI (PoE)• La = Link Aggregation• Mf = Maximum Frame Size
MED TLVs Enabled for Tx	List of optional LLDP-MED TLVs enabled for transmission: <ul style="list-style-type: none">• Mc = LLDP-MED Capabilities• Np = Network Policy• Lo = Location Information,• Pe = Extended Power-Via-MDI• In = Inventory

Related commands [show lldp](#)
[show running-config lldp](#)

show lldp local-info

Overview This command displays local LLDP information that can be transmitted through specified ports. If no port list is entered, local LLDP information for all ports is displayed.

Syntax `show lldp local-info [base] [dot1] [dot3] [med] [interface <port-list>]`

Parameter	Description
base	Information for base TLVs.
dot1	Information for 802.1 TLVs.
dot3	Information for 802.3 TLVs.
med	Information for LLDP-MED TLVs.
<port-list>	The ports for which the local information is to be shown.

Mode User Exec and Privileged Exec

Usage notes Whether and which local information is transmitted in advertisements via a port depends on:

- whether the port is set to transmit LLDP advertisements ([lldp transmit receive](#) command)
- which TLVs it is configured to send ([lldp tlv-select](#) command, [lldp med-tnv-select](#) command)

Examples To display local information transmitted via all ports, use the command:

```
awplus# show lldp local-info
```

Output Figure 58-3: Example output from **show lldp local-info**

```
LLDP Local Information:

Local port1.0.1:
  Chassis ID Type ..... MAC address
  Chassis ID ..... 0015.77c9.7453
  Port ID Type ..... Interface alias
  Port ID ..... port1.0.1
  TTL ..... 120
  Port Description ..... [not configured]
```

```
System Name ..... awplus
System Description ..... Allied Telesis router/switch, AW+
                          v5.4.6
System Capabilities - Supported .. Bridge, Router
                    - Enabled .... Bridge, Router
Management Address ..... 192.168.1.6
Port VLAN ID (PVID) ..... 1
Port & Protocol VLAN - Supported . Yes
                    - Enabled ... No
                    - VIDs ..... 0
VLAN Names ..... default
Protocol IDs ..... 9000, 0026424203000000, 888e01, aaaa03,
                    88090101, 00540000e302, 0800, 0806, 86dd
MAC/PHY Auto-negotiation ..... Supported, Enabled
  Advertised Capability ..... 1000BaseTFD, 100BaseTXFD, 100BaseTX,
                              10BaseTFD, 10BaseT
  Operational MAU Type ..... 1000BaseTFD (30)
Power Via MDI (PoE) ..... Supported, Enabled
  Port Class ..... PSE
  Pair Control Ability ..... Disabled
  Power Class ..... Unknown
Link Aggregation ..... Supported, Disabled
Maximum Frame Size ..... 1522
LLDP-MED Device Type ..... Network Connectivity
LLDP-MED Capabilities ..... LLDP-MED Capabilities, Network Policy,
                              Location Identification,
                              Extended Power - PSE, Inventory
Network Policy ..... [not configured]
Location Identification ..... Civic Address
  Country Code ..... NZ
  City ..... Christchurch
  Street Suffix ..... Avenue
  House Number ..... 27
  Primary Road Name ..... Nazareth
Location Identification ..... ELIN
  ELIN ..... 123456789012
LLDP-MED Device Type ..... Network Connectivity
LLDP-MED Capabilities ..... LLDP-MED Capabilities, Network Policy,
                              Location Identification,
                              Extended Power - PSE, Inventory
Extended Power Via MDI (PoE) ..... PSE
  Power Source ..... Primary Power
  Power Priority ..... Low
  Power Value ..... 4.4 Watts
Inventory Management:
  Hardware Revision ..... A-0
  Firmware Revision ..... 1.1.0
  Software Revision ..... v5.4.6
  Serial Number ..... G1Q78900B
  Manufacturer Name ..... Allied Telesis Inc.
  Model Name ..... AT-x930-52GPX
  Asset ID ..... [zero length]
```

Table 58-1: Parameters in the output of **show lldp local-info**

Parameter	Description
Chassis ID Type	Type of the Chassis ID.
Chassis ID	Chassis ID that uniquely identifies the local device.
Port ID Type	Type of the Port ID.
Port ID	Port ID of the local port through which advertisements are sent.
TTL	Number of seconds that the information advertised by the local port remains valid.
Port Description	Port description of the local port, as specified by the description (interface) command.
System Name	System name, as specified by the hostname command.
System Description	System description.
System Capabilities (Supported)	Capabilities that the local port supports.
System Capabilities (Enabled)	Enabled capabilities on the local port.
Management Addresses	Management address associated with the local port. To change this, use the lldp management-address command.
Port VLAN ID (PVID)	VLAN identifier associated with untagged or priority tagged frames received via the local port.
Port & Protocol VLAN (Supported)	Whether Port & Protocol VLANs (PPV) is supported on the local port.
Port & Protocol VLAN (Enabled)	Whether the port is in one or more Port & Protocol VLANs.
Port & Protocol VLAN (VIDs)	List of identifiers for Port & Protocol VLANs that the port is in.
VLAN Names	List of VLAN names for VLANs that the local port is assigned to.
Protocol IDs	List of protocols that are accessible through the local port.
MAC/PHY Auto-negotiation	Auto-negotiation support and current status of the 802.3 LAN on the local port.

Table 58-1: Parameters in the output of **show lldp local-info** (cont.)

Parameter	Description
Power Via MDI (PoE)	PoE-capability and current status on the local port.
Port Class	Whether the device is a PSE (Power Sourcing Entity) or a PD (Powered Device)
Pair Control Ability	Whether power pair selection can be controlled
Power Pairs	Which power pairs are selected for power ("Signal Pairs" or "Spare Pairs") if pair selection can be controlled
Power Class	The power class of the PD device on the port (class 0, 1, 2, 3 or 4)
Link Aggregation	Whether the link is capable of being aggregated and it is currently in an aggregation.
Aggregated Port-ID	Aggregated port identifier.
Maximum Frame Size	The maximum frame size capability of the implemented MAC and PHY.
LLDP-MED Device Type	LLDP-MED device type
LLDP-MED Capabilities	Capabilities LLDP-MED capabilities supported on the local port.
Network Policy	List of network policies configured on the local port.
VLAN ID	VLAN identifier for the port for the specified application type
Tagged Flag	Whether the VLAN ID is to be used as tagged or untagged
Layer-2 Priority:	Layer 2 User Priority (in the range 0 to 7)
DSCP Value	Diffserv codepoint (in the range 0 to 63)
Location Identification	Location configured on the local port.
Extended Power Via MDI (PoE)	PoE-capability and current status of the PoE parameters for Extended Power-Via-MDI TLV on the local port.
Power Source	The power source the switch currently uses; either primary power or backup power.
Power Priority	The power priority configured on the port; either critical, high or low.

Table 58-1: Parameters in the output of **show lldp local-info** (cont.)

Parameter	Description
Power Value	The total power the switch can source over a maximum length cable to a PD device on the port. The value shows the power value in Watts from the PD side.
Inventory Management	Inventory information for the device.

Related commands

- [description \(interface\)](#)
- [hostname](#)
- [lldp transmit receive](#)

show lldp neighbors

Overview This command displays a summary of information received from neighbors via specified ports. If no port list is supplied, neighbor information for all ports is displayed.

Syntax `show lldp neighbors [interface <port-list>]`

Parameter	Description
<port-list>	The ports for which the neighbor information is to be shown.

Mode User Exec and Privileged Exec

Examples To display neighbor information received via all ports, use the command:

```
awplus# show lldp neighbors
```

Output Figure 58-4: Example output from the **show lldp neighbors** command

Table 59: Parameters in the output of the **show lldp neighbors** command

Parameter	Description
Local Port	Local port on which the neighbor information was received.
Neighbor Chassis ID	Chassis ID that uniquely identifies the neighbor.
Neighbor Port Name	Port ID of the neighbor.
Neighbor Sys Name	System name of the LLDP neighbor.
Neighbor Capability	Capabilities that are supported and enabled on the neighbor.
System Capability	System Capabilities of the LLDP neighbor.
MED Device Type	LLDP-MED Device class (Class I, II, III or Network Connectivity)
MED Power Source	LLDP-MED Power Source

Related commands [show lldp neighbors detail](#)

show lldp neighbors detail

Overview This command displays in detail the information received from neighbors via specified ports. If no port list is supplied, detailed neighbor information for all ports is displayed.

Syntax `show lldp neighbors detail [base] [dot1] [dot3] [med] [interface <port-list>]`

Parameter	Description
base	Information for base TLVs.
dot1	Information for 802.1 TLVs.
dot3	Information for 803.1 TLVs.
med	Information for LLDP-MED TLVs.
<port-list>	The ports for which the neighbor information is to be shown.

Mode User Exec and Privileged Exec

Examples To display detailed neighbor information received via all ports, use the command:

```
awplus# show lldp neighbors detail
```

Output Figure 58-5: Example output from the **show lldp neighbors detail** command

```
awplus#show lldp neighbors detail interface port1.0.1
LLDP Detailed Neighbor Information:

Local port1.0.1:
  Neighbors table last updated 0 hrs 0 mins 40 secs ago
  Chassis ID Type ..... MAC address
  Chassis ID ..... 0004.cd28.8754
  Port ID Type ..... Interface alias
  Port ID ..... port1.0.6
  TTL ..... 120 (secs)
  Port Description ..... [zero length]
  System Name ..... awplus
  System Description ..... Allied Telesis router/switch, AW+ v5.4.6
  System Capabilities - Supported .. Bridge, Router
                    - Enabled .... Bridge, Router
  Management Addresses ..... 0004.cd28.8754
  Port VLAN ID (PVID) ..... 1
  Port & Protocol VLAN - Supported . Yes
                    - Enabled ... Yes
                    - VIDs ..... 5
  VLAN Names ..... default, vlan5
  Protocol IDs ..... 9000, 0026424203000000, 888e01, 8100,
                    88090101, 00540000e302, 0800, 0806, 86dd
  MAC/PHY Auto-negotiation ..... Supported, Enabled
    Advertised Capability ..... 1000BaseTFD, 100BaseTXFD, 100BaseTX,
                                10BaseTFD, 10BaseT
    Operational MAU Type ..... 1000BaseTFD (30)
  Power Via MDI (PoE) ..... [not advertised]
  Link Aggregation ..... Supported, Disabled
  Maximum Frame Size ..... 1522 (Octets)
  LLDP-MED Device Type ..... Network Connectivity
  LLDP-MED Capabilities ..... LLDP-MED Capabilities, Network Policy,
                                Location Identification,
                                Extended Power - PSE, Inventory
  Network Policy ..... [not advertised]
  Location Identification ..... [not advertised]
  Extended Power Via MDI (PoE) ..... PD
    Power Source ..... PSE
    Power Priority ..... High
    Power Value ..... 4.4 Watts
  Inventory Management:
    Hardware Revision ..... X1-0
    Firmware Revision ..... 1.1.0
    Software Revision ..... v5.4.6
    Serial Number ..... M1NB73008
    Manufacturer Name ..... Allied Telesis Inc.
    Model Name ..... x230-28GP
    Asset ID ..... [zero length]
```

Table 60: Parameters in the output of the **show lldp neighbors detail** command

Parameter	Description
Chassis ID Type	Type of the Chassis ID.
Chassis ID	Chassis ID that uniquely identifies the neighbor.
Port ID Type	Type of the Port ID.
Port ID	Port ID of the neighbor.
TTL	Number of seconds that the information advertised by the neighbor remains valid.
Port Description	Port description of the neighbor's port.
System Name	Neighbor's system name.
System Description	Neighbor's system description.
System Capabilities (Supported)	Capabilities that the neighbor supports.
System Capabilities (Enabled)	Capabilities that are enabled on the neighbor.
Management Addresses	List of neighbor's management addresses.
Port VLAN ID (PVID)	VLAN identifier associated with untagged or priority tagged frames for the neighbor port.
Port & Protocol VLAN (Supported)	Whether Port & Protocol VLAN is supported on the LLDP neighbor.
Port & Protocol VLAN (Enabled)	Whether Port & Protocol VLAN is enabled on the LLDP neighbor.
Port & Protocol VLAN (VIDs)	List of Port & Protocol VLAN identifiers.
VLAN Names	List of names of VLANs that the neighbor's port belongs to.
Protocol IDs	List of protocols that are accessible through the neighbor's port.
MAC/PHY Auto-negotiation	Auto-negotiation configuration and status
Power Via MDI (PoE)	PoE configuration and status of 802.3 Power-Via-MDI TLV
Link Aggregation	Link aggregation information

Table 60: Parameters in the output of the **show lldp neighbors detail** command (cont.)

Parameter	Description
Maximum Frame Size	The maximum frame size capability
LLDP-MED Device Type	LLDP-MED Device type
LLDP-MED Capabilities	LLDP-MED capabilities supported
Network Policy	List of network policies
Location Identification	Location information
Extended Power Via MDI (PoE)	PoE-capability and current status
Inventory Management	Inventory information

Related commands [show lldp neighbors](#)

show lldp statistics

Overview This command displays the global LLDP statistics (packet and event counters).

Syntax show lldp statistics

Mode User Exec and Privileged Exec

Example To display global LLDP statistics information, use the command:

```
awplus# show lldp statistics
```

Output

Table 61: Example output from the **show lldp statistics** command

```
awplus# show lldp statistics

Global LLDP Packet and Event counters:

Frames:   Out ..... 345
          In ..... 423
          In Errored ..... 0
          In Dropped ..... 0
TLVs:    Unrecognized ..... 0
          Discarded ..... 0
Neighbors: New Entries ..... 20
           Deleted Entries ..... 20
           Dropped Entries ..... 0
           Entry Age-outs ..... 20
```

Table 62: Parameters in the output of the **show lldp statistics** command

Parameter	Description
Frames Out	Number of LLDPDU frames transmitted.
Frames In	Number of LLDPDU frames received.
Frames In Errored	Number of invalid LLDPDU frames received.
Frames In Dropped	Number of LLDPDU frames received and discarded for any reason.
TLVs Unrecognized	Number of LLDP TLVs received that are not recognized but the TLV type is in the range of reserved TLV types.
TLVs Discarded	Number of LLDP TLVs discarded for any reason.
Neighbors New Entries	Number of times the information advertised by neighbors has been inserted into the neighbor table.

Table 62: Parameters in the output of the **show lldp statistics** command (cont.)

Parameter	Description
Neighbors Deleted Entries	Number of times the information advertised by neighbors has been removed from the neighbor table.
Neighbors Dropped Entries	Number of times the information advertised by neighbors could not be entered into the neighbor table because of insufficient resources.
Neighbors Entry Age-outs Entries	Number of times the information advertised by neighbors has been removed from the neighbor table because the information TTL interval has expired.

Related commands

- [clear lldp statistics](#)
- [show lldp statistics interface](#)

show lldp statistics interface

Overview This command displays the LLDP statistics (packet and event counters) for specified ports. If no port list is supplied, LLDP statistics for all ports are displayed.

Syntax `show lldp statistics interface [<port-list>]`

Parameter	Description
<port-list>	The ports for which the statistics are to be shown.

Mode User Exec and Privileged Exec

Examples To display LLDP statistics information for all ports, use the command:

```
awplus# show lldp statistics interface
```

Output

Table 63: Example output from the **show lldp statistics interface** command

--

Table 64: Parameters in the output of the **show lldp statistics interface** command

Parameter	Description
Frames Out	Number of LLDPDU frames transmitted.
Frames In	Number of LLDPDU frames received.
Frames In Errored	Number of invalid LLDPDU frames received.
Frames In Dropped	Number of LLDPDU frames received and discarded for any reason.
TLVs Unrecognized	Number of LLDP TLVs received that are not recognized but the TLV type is in the range of reserved TLV types.
TLVs Discarded	Number of LLDP TLVs discarded for any reason.
Neighbors New Entries	Number of times the information advertised by neighbors has been inserted into the neighbor table.
Neighbors Deleted Entries	Number of times the information advertised by neighbors has been removed from the neighbor table.

Table 64: Parameters in the output of the **show lldp statistics interface** command (cont.)

Parameter	Description
Neighbors Dropped Entries	Number of times the information advertised by neighbors could not be entered into the neighbor table because of insufficient resources.
Neighbors Entry Age-outs Entries	Number of times the information advertised by neighbors has been removed from the neighbor table because the information TTL interval has expired.

Related commands [clear lldp statistics](#)
[show lldp statistics](#)

show location

Overview Use this command to display selected location information configured on the switch.

Syntax

```
show location {civic-location|coord-location|elin-location}
show location {civic-location|coord-location|elin-location}
identifier {<civic-loc-id>|<coord-loc-id>|<elin-loc-id>}
show location {civic-location|coord-location|elin-location}
interface <port-list>
```

Parameter	Description
civic-location	Display civic location information.
coord-location	Display coordinate location information.
elin-location	Display ELIN (Emergency Location Identifier Number) information.
<civic-loc-id>	Civic address location identifier, in the range 1 to 4095.
<coord-loc-id>	Coordinate location identifier, in the range 1 to 4095.
<elin-loc-id>	ELIN location identifier, in the range 1 to 4095.
<port-list>	Ports to display information about.

Mode User Exec and Privileged Exec

Examples To display a civic address location configured on port 1.0.1, use the command:

```
awplus# show location civic-location interface port1.0.1
```

Table 65: Example output from the **show location** command

```
awplus# show location civic-location interface port1.0.1
Port      ID      Element Type      Element Value
-----
1.0.1    1      Country           NZ
          City           Christchurch
          Street-suffix  Avenue
          House-number   27
          Primary-road-name Nazareth
```

To display coordinate location information configured on the identifier 1, use the command:

```
awplus# show location coord-location identifier 1
```

Table 66: Example output from the **show location** command

```
awplus# show location coord-location identifier 1
  ID  Element Type                Element Value
-----
  1   Latitude Resolution         15 bits
      Latitude                    38.8986481130123138427734375 degrees
      Longitude Resolution        15 bits
      Longitude                    130.2323232293128967285156250 degrees
      Altitude Resolution         10 bits
      Altitude                    2.50000000 meters
      Map Datum                   WGS 84
```

The coordinate location information displayed may differ from the information entered because it is stored in binary format. For more information, see the [location coord-location configuration](#) command.

To display all ELIN location information configured on the switch, use the command:

```
awplus# show location elin-location
```

Table 67: Example output from the **show location elin-location** command

```
awplus# show location elin-location
  ID  ELIN
-----
  1   1234567890
  2   5432154321
```

Related commands

- [location elin-location-id](#)
- [location civic-location identifier](#)
- [location civic-location configuration](#)
- [location coord-location identifier](#)
- [location coord-location configuration](#)
- [location elin-location](#)

Command changes

Version 5.4.8-2.1: Command added to AR2050V, AR3050S, AR4050S

59

Mail (SMTP) Commands

Introduction

Overview This chapter provides an alphabetical reference for commands used to configure mail. The mail feature uses Simple Mail Transfer Protocol (SMTP) to transfer mail from an internal email client operating within the AlliedWare Plus device. This feature is typically used to email event notifications to an external email server from the AlliedWare Plus device.

For information on using the mail feature, see the [Mail \(SMTP\) Feature Overview and Configuration Guide](#).

- Command List**
- [“debug mail”](#) on page 3319
 - [“delete mail”](#) on page 3320
 - [“mail”](#) on page 3321
 - [“mail from”](#) on page 3323
 - [“mail smtpserver”](#) on page 3324
 - [“mail smtpserver authentication”](#) on page 3325
 - [“mail smtpserver port”](#) on page 3327
 - [“show counter mail”](#) on page 3329
 - [“show mail”](#) on page 3330
 - [“undebug mail”](#) on page 3331

debug mail

Overview This command turns on debugging for sending emails.
The **no** variant of this command turns off debugging for sending emails.

Syntax debug mail
no debug mail

Mode Privileged Exec

Examples To turn on debugging for sending emails, use the command:

```
awplus# debug mail
```

To turn off debugging for sending emails, use the command:

```
awplus# no debug mail
```

Related commands

- delete mail
- mail
- mail from
- mail smtpserver
- show counter mail
- show mail
- undebug mail

delete mail

Overview This command deletes mail from the queue.

You need the *mail-id* from the **show mail** command output to delete specific emails, or use the **all** parameter to clear all messages in the queue completely.

Syntax `delete mail [mail-id <mail-id>|all]`

Parameter	Description
mail-id	Deletes a single mail from the mail queue.
	<mail-id> A unique mail ID number. Use the show mail command to display this for an item of mail.
all	Delete all the mail in the queue.

Mode Privileged Exec

Examples To delete the unique mail item "20060912142356.1234" from the queue, use the command:

```
awplus# delete mail 20060912142356.1234
```

To delete all mail from the queue, use the command:

```
awplus# delete mail all
```

Related commands

- [debug mail](#)
- [mail](#)
- [mail from](#)
- [mail smtpserver](#)
- [show mail](#)

mail

Overview This command sends an email using the SMTP protocol. If you specify a file the text inside the file is sent in the message body.

If you do not specify the **to**, **file**, or **subject** parameters, the CLI prompts you for the missing information.

Before you can send mail using this command, you must specify the sending email address using the [mail from](#) command and a mail server using the [mail smtpserver](#) command.

Syntax mail [to <to>] [subject <subject>] [file <filename>]

Parameter	Description
to	The email recipient. <to> Email address.
subject	Description of the subject of this email. Use quote marks when the subject text contains spaces. <subject> String.
file	File to insert as text into the message body. <filename> String.

Mode Privileged Exec

Usage notes When you use the **mail** command you can use parameter substitutions in the subject field. The following table lists the parameters that can be substituted and their descriptions:

Parameter	Description
<%N>	When this parameter is specified, the %N is replaced by the host name of your device.
<%S>	When this parameter is specified, the %S is replaced by the serial number of your device.
<%D> <%L> <%T>	When any of these parameters is specified, they are replaced by the current date and time (local time) on your device.
<%U>	When this parameter is specified, the %U is replaced by the current date and time (UTC time) on your device.

NOTE: If no local time is configured, it will use UTC.

Examples To send an email to "admin@example.com" with the subject "test email" and with the message body inserted from the file "test.conf", use the command:

```
awplus# mail to admin@example.com subject "test email" filename  
test.conf
```

To send an email using parameter substitutions for the host name, serial number and date, use the commands:

```
awplus# mail to admin@example.com subject "Sending email from  
Hostname:%N Serial Number:%S Date:%T"
```

**Related
commands**

[debug mail](#)

[delete mail](#)

[mail from](#)

[mail smtpserver](#)

[mail smtpserver authentication](#)

[mail smtpserver port](#)

[show counter mail](#)

[show mail](#)

mail from

Overview This command sets an email address as the sender. You must specify a sending email address with this command before you can send email.

Use the **no** variant of this command to remove the “mail from” address.

Syntax mail from <from>
no mail from

Parameter	Description
<from>	The email address that the mail is sent from (also known as the hostname).

Mode Global Configuration

Example To set up your email address as the sender “kaji@nerv.com”, use the command:

```
awplus(config)# mail from kaji@nerv.com
```

Related commands

- debug mail
- delete mail
- mail
- mail smtpserver
- show counter mail
- show mail
- undebug mail

mail smtpserver

Overview This command specifies the IP address or domain name of the SMTP server that your device sends email to. You must specify a mail server with this command before you can send email.

Use the **no** variant of this command to remove the configured mail server.

Syntax mail smtpserver {<ip-address>|<name>}
no mail smtpserver

Parameter	Description
<ip-address>	Internet Protocol (IP) address for the mail server.
<name>	Domain name (FQDN) for the mail server (also known as the host name).

Mode Global Configuration

Usage notes If you specify the server by specifying its domain name, you must also ensure that the DNS client on your device is enabled. It is enabled by default but if it has been disabled, you can re-enable it by using the [ip domain-lookup](#) command.

Examples To specify a mail server at "192.168.0.1", use the command:

```
awplus(config)# mail smtpserver 192.168.0.1
```

To specify a mail server that has a host name of "smtp.example.com", use the command:

```
awplus(config)# mail smtpserver smtp.example.com
```

To remove the configured mail server, use the command:

```
awplus(config)# no mail smtpserver
```

Related commands

- [debug mail](#)
- [delete mail](#)
- [mail](#)
- [mail from](#)
- [show counter mail](#)
- [show mail](#)

mail smtpserver authentication

Overview Use this command to configure SMTP mail server authentication.

Use the **no** variant of this command to remove the configured SMTP mail server authentication.

Syntax mail smtpserver authentication {crammd5|login|plain} username <username> password [8] <password>
no mail smtpserver authentication

Parameter	Description
crammd5	This is a Challenge Request Authentication Mechanism based on the HMAC-MD5 mechanism and is the most secure option.
login	A BASE64 encryption method
plain	A BASE64 encryption method
<username>	Registered user name
8	The registered user password is presented in an already encrypted format. This is how the running configuration stores the plain text password and is not for general use.
<password>	Registered user password

Default No authentication option is set by default.

Mode Global Configuration

Usage notes You cannot change the IP address or Domain Name of the SMTP server if authentication is configured. If you attempt to change it when authentication is configured, the following error message is displayed:

```
% Error: authentication configuration still exists
```

Examples To configure the SMTP mail server authentication to crammd5, use the commands:

```
awplus# configure terminal  
awplus(config)# mail smtpserver authentication crammd5 username  
admin password unguessablePassword
```

To remove SMTP mail server authentication, use the commands:

```
awplus# configure terminal  
awplus(config)# no mail smtpserver authentication
```

Output Figure 59-1: Example output from **show mail**:

```
awplus#show mail
Mail Settings
-----
State                : Alive
SMTP Server          : 1.2.3.4
Host Name            : admin@example.com
Authentication       : crammd5
Username             : admin
Debug                : Disabled

awplus#show running-config
!
mail smtpserver authentication plain username admin password 8
aF0a9pkjbmXGfl6TlSk/GakeIK5tMYN6LqMYT8Ia2qw=
!
```

**Related
commands**

[debug mail](#)
[delete mail](#)
[mail](#)
[mail from](#)
[mail smtpserver](#)
[mail smtpserver port](#)
[show counter mail](#)
[show mail](#)

**Command
changes**

Version 5.4.8-1.1: command added

mail smtpserver port

Overview Use this command to configure the SMTP mail client/server communication port. Use the **no** variant of this command to remove the configured port and set it back to the default port 25.

Syntax mail smtpserver port <port>
no mail smtpserver port

Parameter	Description
<port>	Port number from the range 1 to 65535

Default Port 25 is the default port.

Mode Global Configuration

Examples To configure the mail server communication over port 587, use the commands:

```
awplus# configure terminal  
awplus(config)# mail smtpserver port 587
```

To remove the configured port and set it back to the default port 25, use the commands:

```
awplus# configure terminal  
awplus(config)# no mail smtpserver port
```

Output Figure 59-2: Example output from **show mail**:

```
awplus#show mail  
Mail Settings  
-----  
State                : Alive  
SMTP Server          : 10.24.165.4  
Host Name             : admin@example.com  
Authentication       : plain  
Username              : admin  
Port                  : 587  
Debug                 : Disabled  
  
awplus#show running-config  
!  
mail smtpserver port 587  
!
```

Related commands [debug mail](#)
[delete mail](#)
[mail](#)

mail from
mail smtpserver
mail smtpserver authentication
show counter mail
show mail

Command changes Version 5.4.8-1.1: command added

show counter mail

Overview This command displays the mail counters.

Syntax `show counter mail`

Mode User Exec and Privileged Exec

Example To show the emails in the queue use the command:

```
awplus# show counter mail
```

Output Figure 59-3: Example output from the **show counter mail** command

```
Mail Client (SMTP) counters
Mails Sent           ..... 2
Mails Sent Fails     ..... 1
```

Table 1: Parameters in the output of the **show counter mail** command

Parameter	Description
Mails Sent	The number of emails sent successfully since the last device restart.
Mails Sent Fails	The number of emails the device failed to send since the last device restart.

- Related commands**
- [debug mail](#)
 - [delete mail](#)
 - [mail](#)
 - [mail from](#)
 - [show mail](#)

show mail

Overview This command displays the emails in the queue.

Syntax show mail

Mode Privileged Exec

Example To display the emails in the queue use the command:

```
awplus# show mail
```

Output Figure 59-4: Example output from the **show mail** command:

```
awplus#show mail
Mail Settings
-----
State                : Alive
SMTP Server          : example.net
Host Name             : test@example.com
Debug                 : Enabled

Messages
-----
To                   : rei@nerv.com
Subject              : The WAN is down
Message-ID           : 20180615121150.8663

To                   : rei@nerv.com
Subject              : WAN is not connecting in lab
Message-ID           : 20180614142502.19308

To                   : rei@nerv.com
Subject              : The LAN is not functioning
Message-ID           : 20180614141911.29709
```

Related commands [delete mail](#)

[mail](#)

[mail from](#)

[mail smtpserver](#)

[show counter mail](#)

[undebug mail](#)

undebug mail

Overview This command applies the functionality of the no [debug mail](#) command.

60

RMON Commands

Introduction

Overview This chapter provides an alphabetical reference for commands used to configure Remote Monitoring (RMON).

For an introduction to RMON and an RMON configuration example, see the [RMON Feature Overview and Configuration Guide](#).

RMON is disabled by default in AlliedWare Plus™. No RMON alarms or events are configured.

For information on filtering and saving command output, see the [“Getting Started with AlliedWare Plus” Feature Overview and Configuration Guide](#).

- Command List**
- [“rmon alarm”](#) on page 3333
 - [“rmon collection history”](#) on page 3336
 - [“rmon collection stats”](#) on page 3337
 - [“rmon event”](#) on page 3338
 - [“show rmon alarm”](#) on page 3339
 - [“show rmon event”](#) on page 3340
 - [“show rmon history”](#) on page 3342
 - [“show rmon statistics”](#) on page 3344

rmon alarm

Overview Use this command to configure an RMON alarm to monitor the value of an SNMP object, and to trigger specified events when the monitored object crosses specified thresholds.

To specify the action taken when the alarm is triggered, use the event index of an event defined by the [rmon event](#) command.

Use the **no** variant of this command to remove the alarm configuration.

NOTE: You can only configure alarms for Eth, tunnel and switch port interfaces.

Syntax **User-defined alarm:**

```
rmon alarm <alarm-index> <oid.index> interval <1-2147483647>
{delta|absolute} rising-threshold <1-2147483647> event
<rising-event-index> falling-threshold <1-2147483647> event
<falling-event-index> [alarmstartup {1|2|3}] [owner <owner>]
```

Eventwatch alarm, do not use (used by Vista Manager EX only):

```
rmon alarm <alarm-index> <oid.index> interval <1-4294967295>
{delta|absolute} rising-threshold <1-2147483647> event
eventwatch falling-threshold <1-2147483647> event eventwatch
[owner <owner>]
```

```
no rmon alarm <alarm-index>
```

Parameter	Description
<alarm-index>	Alarm entry index value from the range 1 to 65535 seconds.
<oid.index>	The variable SNMP MIB Object Identifier (OID) name to be monitored, for either etherStats or etherHistory entries. The entries can be either of the following formats: - etherStatsEntry.<field>.<stats-index> or etherHistoryEntry.<field>.<history-index>, or - etherStatsFieldName.<stats-index> or etherHistoryFieldName.<history-index>. To define the <stats-index>, use the rmon collection stats command. To define the <history-index>, use the rmon collection history command.
interval <1-2147483647>	Polling interval in seconds from the range 1 to 2147483647.
delta	The RMON MIB alarmSampleType: the change in the monitored MIB object value between the beginning and end of the polling interval.
absolute	The RMON MIB alarmSampleType: the value of the monitored MIB object.

Parameter	Description
rising-threshold <1-2147483647>	Rising threshold value of the alarm entry in seconds from the range 1 to 2147483647.
<rising-event-index>	From the range 1 to 65535 seconds. The event to be triggered when the monitored object value reaches the rising threshold value. This is the event index of an event specified by the <code>rmon event</code> command.
eventwatch	The alarm triggers an eventwatch event. This mechanism is used by Vista Manager EX, the Allied Telesis network management and monitoring tool. Do not use this parameter; use the <code><rising-event-index></code> parameter instead.
falling-threshold <1-2147483647>	Falling threshold value of the alarm entry in seconds from the range 1 to 2147483647.
<falling-event-index>	From the range 1 to 65535 seconds. The event to be triggered when the monitored object value reaches the falling threshold value. This is an event index of an event specified by the <code>rmon event</code> command.
eventwatch	The alarm triggers an eventwatch event. This mechanism is used by Vista Manager EX, the Allied Telesis network management and monitoring tool. Do not use this parameter; use the <code><rising-event-index></code> parameter instead.
alarmstartup {1 2 3}	Whether RMON can trigger a falling alarm (1), a rising alarm (2) or either (3) when you first start monitoring. See the Usage section for more information. The default is setting 3 (either).
owner <owner>	Arbitrary owner name to identify the alarm entry.

Default By default, there are no alarms.

Mode Global Configuration

Usage notes RMON alarms have a rising and falling threshold. Once the alarm monitoring is operating, you cannot have a falling alarm unless there has been a rising alarm and vice versa.

However, when you start RMON alarm monitoring, an alarm must be generated without the other type of alarm having first been triggered. The **alarmstartup** parameter allows this. It is used to say whether RMON can generate a rising alarm (1), a falling alarm (2) or either alarm (3) as the first alarm.

Note that you specify the SNMP MIB Object Identifier (OID) as a dotted decimal value, using one of the following forms:

- etherStatsEntry.<field>.<stats-index> or
etherHistoryEntry.<field>.<history-index>.
For example, etherHistoryEntry.8.8

- or, etherStatsFieldName.<stats-index> or etherHistoryFieldName.<history-index>. For example, etherHistoryMulticastPkts.8

If you enter the first form (etherHistoryEntry.8.8), the device will save it as the second form (etherHistoryMulticastPkts.8) in the running-config.

Example To configure an alarm to:

- monitor the change per minute in the etherStatsPkt value for interface 22 (defined by stats-index 22 in the [rmon collection stats](#) command)
- and trigger event 2 (defined by the [rmon event](#) command) when the change reaches the rising threshold 400
- and trigger event 3 when it reaches the falling threshold 200
- and identify this alarm as belonging to the user with username Maria

use the following commands:

```
awplus# configure terminal
awplus(config)# rmon alarm 229 etherStatsEntry.22.5 interval 60
delta rising-threshold 400 event 2 falling-threshold 200 event
3 alarmstartup 3 owner maria
```

To configure an alarm that:

- every 10 seconds, checks the number of multicast packets
- in the latest history control table entry controlled by history-index 8
- to see if the number of packets has increased to 15 or dropped to 5
- and if it has, trigger event 10

use either of the following commands:

```
awplus(config)# rmon alarm 56 etherHistoryMulticastPkts.8
interval 10 absolute rising-threshold 15 event 10
falling-threshold 5 event 10

awplus(config)# rmon alarm 56 etherHistoryEntry.8.8 interval 10
absolute rising-threshold 15 event 10 falling-threshold 5 event
10
```

Related commands [rmon collection history](#)
[rmon collection stats](#)
[rmon event](#)

rmon collection history

Overview Use this command to create a history statistics control group to store a specified number of snapshots (buckets) of the standard RMON statistics for the switch port, and to collect these statistics at specified intervals. If there is sufficient memory available, then the device will allocate memory for storing the set of buckets that comprise this history control.

Use the **no** variant of this command to remove the specified history control configuration.

NOTE: A history can only be collected for tunnels, eth interfaces and switch port interfaces.

Syntax `rmon collection history <history-index> [buckets <1-65535>]
[interval <1-3600>] [owner <owner>]
no rmon collection history <history-index>`

Parameter	Description
<history-index>	A unique RMON history control entry index value from the range 1 to 65535.
buckets <1-65535>	Number of requested buckets to store snapshots from the range 1 to 65535. The default is 50 buckets.
interval <1-3600>	Polling interval in seconds. Default 1800 second polling interval from the range 1 to 3600.
owner <owner>	Owner name to identify the entry.

Default The default interval is 1800 seconds and the default number of buckets is 50.

Mode Interface Configuration

Example To create a history statistics control group with ID 200 to store 500 snapshots with an interval of 600 seconds, use the commands:

```
awplus# configure terminal  
awplus(config-if)# rmon collection history 200 buckets 500  
interval 600 owner herbert
```

To disable the history statistics control group, use the commands:

```
awplus# configure terminal  
awplus(config-if)# no rmon collection history 200
```

Related commands

- [rmon alarm](#)
- [rmon collection stats](#)
- [rmon event](#)

rmon collection stats

Overview Use this command to enable the collection of RMON statistics on a switch port, and assign an index number by which to access these collected statistics.

Use the **no** variant of this command to stop collecting RMON statistics on this switch port.

NOTE: *Statistics can only be collected for tunnels, eth interfaces and switch port interfaces.*

Syntax `rmon collection stats <collection-index> [owner <owner>]`
`no rmon collection stats <collection-index>`

Parameter	Description
<code><collection-index></code>	Give this collection of statistics an index number to uniquely identify it. This is the index to use to access the statistics collected for this switch port. Use a number in the range of 1 to 65535.
<code>owner <owner></code>	An arbitrary owner name to identify this statistics collection entry.

Default RMON statistics are not enabled by default.

Mode Interface Configuration

Example To enable the collection of RMON statistics with a statistics index of 200, use the commands:

```
awplus# configure terminal  
awplus(config-if)# rmon collection stats 200 owner myrtle
```

To stop collecting RMON statistics, use the commands:

```
awplus# configure terminal  
awplus(config-if)# no rmon collection stats 200
```

Related commands [rmon alarm](#)
[rmon collection history](#)
[rmon event](#)

rmon event

Overview Use this command to create an event definition for a log or a trap or both. Then you can use this event index in the [rmon alarm](#) command to indicate whether to send an SNMP trap or log message (or both) when an alarm is triggered.

Use the **no** variant of this command to remove the event definition.

Syntax

```
rmon event <event-index> [description <description>|owner <owner>| trap <trap>]
rmon event <event-index> [log [description <description>|owner <owner>|trap <trap>] ]
rmon event <event-index> [log trap [description <description>|owner <owner>] ]
no rmon event <event-index>
```

Parameter	Description
<event-index>	<1-65535> Unique event entry index value.
log	Log event type.
trap	Trap event type.
log trap	Log and trap event type.
description<description>	Event entry description.
owner <owner>	Owner name to identify the entry.

Default No event is configured by default.

Mode Global Configuration

Example To create an event definition with an index of 299 for a log, use this command:

```
awplus# configure terminal
awplus(config)# rmon event 299 log description cond3 owner
alfred
```

To remove the event definition, use the command:

```
awplus# configure terminal
awplus(config)# no rmon event 299
```

Related commands [rmon alarm](#)

show rmon alarm

Overview Use this command to display the alarms and threshold configured for the RMON probe.

Syntax `show rmon alarm`

Mode User Exec and Privileged Exec

Example To display the alarms and threshold, use this command:

```
awplus# show rmon alarm
```

Related commands [rmon alarm](#)

show rmon event

Overview Use this command to display the events configured for the RMON probe.

Syntax show rmon event

Mode User Exec and Privileged Exec

Output Figure 60-1: Example output from the **show rmon event** command

```
awplus#sh rmon event
event Index = 787
  Description TRAP
  Event type log & trap
  Event community name gopher
  Last Time Sent = 0
  Owner RMON_SNMP

event Index = 990
  Description TRAP
  Event type trap
  Event community name teabo
  Last Time Sent = 0
  Owner RMON_SNMP
```

NOTE: The following etherStats counters are not currently available for Layer 3 interfaces:

- etherStatsBroadcastPkts
- etherStatsCRCAlignErrors
- etherStatsUndersizePkts
- etherStatsOversizePkts
- etherStatsFragments
- etherStatsJabbers
- etherStatsCollisions
- etherStatsPkts64Octets
- etherStatsPkts65to127Octets
- etherStatsPkts128to255Octets
- etherStatsPkts256to511Octets
- etherStatsPkts512to1023Octets
- etherStatsPkts1024to1518Octets

Example To display the events configured for the RMON probe, use this command:

```
awplus# show rmon event
```

**Related
commands** [rmon event](#)

show rmon history

Overview Use this command to display the parameters specified on all the currently defined RMON history collections on the device.

Syntax `show rmon history`

Mode User Exec and Privileged Exec

Output Figure 60-2: Example output from the **show rmon history** command

```
awplus#sh rmon history
history index = 56
    data source ifindex = 4501
    buckets requested = 34
    buckets granted = 34
    Interval = 2000
    Owner Andrew

history index = 458
    data source ifindex = 5004
    buckets requested = 400
    buckets granted = 400
    Interval = 1500
    Owner trev
=====
```

NOTE: The following etherStats counters are not currently available for Layer 3 interfaces:

- etherStatsBroadcastPkts
- etherStatsCRCAlignErrors
- etherStatsUndersizePkts
- etherStatsOversizePkts
- etherStatsFragments
- etherStatsJabbers
- etherStatsCollisions
- etherStatsPkts64Octets
- etherStatsPkts65to127Octets
- etherStatsPkts128to255Octets
- etherStatsPkts256to511Octets
- etherStatsPkts512to1023Octets
- etherStatsPkts1024to1518Octets

Example To display the parameters specified on all the currently defined RMON history collections, use the commands:

```
awplus# show rmon history
```

Related commands [rmon collection history](#)

show rmon statistics

Overview Use this command to display the current values of the statistics for all the RMON statistics collections currently defined on the device.

Syntax `show rmon statistics`

Mode User Exec and Privileged Exec

Example To display the current values of the statistics for all the RMON statistics collections, use the commands:

```
awplus# show rmon statistics
```

Output Figure 60-3: Example output from the **show rmon statistics** command

```
awplus#show rmon statistics
rmon collection index 45
stats->ifindex = 4501
input packets 1279340, bytes 85858960, dropped 00, multicast packets 1272100
output packets 7306090, bytes 268724, multicast packets 7305660 broadcast
packets 290
rmon collection index 679
stats->ifindex = 5013
input packets 00, bytes 00, dropped 00, multicast packets 00
output packets 8554550, bytes 26777324, multicast packets 8546690 broadcast
packets 7720
```

NOTE: The following etherStats counters are not currently available for Layer 3 interfaces:

- etherStatsBroadcastPkts
- etherStatsCRCAlignErrors
- etherStatsUndersizePkts
- etherStatsOversizePkts
- etherStatsFragments
- etherStatsJabbers
- etherStatsCollisions
- etherStatsPkts64Octets
- etherStatsPkts65to127Octets
- etherStatsPkts128to255Octets
- etherStatsPkts256to511Octets
- etherStatsPkts512to1023Octets
- etherStatsPkts1024to1518Octets

**Related
commands** [rmon collection stats](#)

61

Secure Shell (SSH) Commands

Introduction

Overview This chapter provides an alphabetical reference for commands used to configure Secure Shell (SSH). For more information, see the [SSH Feature Overview and Configuration Guide](#).

- Command List**
- “[banner login \(SSH\)](#)” on page 3348
 - “[clear ssh](#)” on page 3349
 - “[crypto key destroy hostkey](#)” on page 3350
 - “[crypto key destroy userkey](#)” on page 3351
 - “[crypto key generate hostkey](#)” on page 3352
 - “[crypto key generate userkey](#)” on page 3354
 - “[crypto key pubkey-chain knownhosts](#)” on page 3355
 - “[crypto key pubkey-chain userkey](#)” on page 3357
 - “[debug ssh client](#)” on page 3359
 - “[debug ssh server](#)” on page 3360
 - “[service ssh](#)” on page 3361
 - “[show banner login](#)” on page 3363
 - “[show crypto key hostkey](#)” on page 3364
 - “[show crypto key pubkey-chain knownhosts](#)” on page 3366
 - “[show crypto key pubkey-chain userkey](#)” on page 3368
 - “[show crypto key userkey](#)” on page 3369
 - “[show running-config ssh](#)” on page 3370
 - “[show ssh](#)” on page 3372
 - “[show ssh client](#)” on page 3374

- [“show ssh server”](#) on page 3375
- [“show ssh server allow-users”](#) on page 3377
- [“show ssh server deny-users”](#) on page 3378
- [“ssh”](#) on page 3379
- [“ssh client”](#) on page 3381
- [“ssh server”](#) on page 3383
- [“ssh server vrf”](#) on page 3385
- [“ssh server allow-users”](#) on page 3386
- [“ssh server authentication”](#) on page 3388
- [“ssh server deny-users”](#) on page 3390
- [“ssh server max-auth-tries”](#) on page 3392
- [“ssh server resolve-host”](#) on page 3393
- [“ssh server scp”](#) on page 3394
- [“ssh server secure-algs”](#) on page 3395
- [“ssh server secure-ciphers”](#) on page 3396
- [“ssh server secure-kex”](#) on page 3397
- [“ssh server secure-mac”](#) on page 3398
- [“ssh server sftp”](#) on page 3399
- [“ssh server tcpforwarding”](#) on page 3400
- [“undebg ssh client”](#) on page 3401
- [“undebg ssh server”](#) on page 3402

banner login (SSH)

Overview This command configures a login banner on the SSH server. This displays a message on the remote terminal of the SSH client before the login prompt. SSH client version 1 does not support this banner.

To add a banner, first enter the command **banner login**, and hit [Enter]. Write your message. You can use any character and spaces. Use Ctrl+D at the end of your message to save the text and re-enter the normal command line mode.

The banner message is preserved if the device restarts.

The **no** variant of this command deletes the login banner from the device.

Syntax banner login
no banner login

Default No banner is defined by default.

Mode Global Configuration

Examples To set a login banner message, use the commands:

```
awplus# configure terminal  
awplus(config)# banner login
```

The screen will prompt you to enter the message:

Type CNTL/D to finish.

... banner message comes here ...

Enter the message. Use Ctrl+D to finish, like this:

```
^D  
awplus(config)#
```

To remove the login banner message, use the commands:

```
awplus# configure terminal  
awplus(config)# no banner login
```

Related commands [show banner login](#)

clear ssh

Overview This command deletes Secure Shell sessions currently active on the device. This includes both incoming and outgoing sessions. The deleted sessions are closed. You can only delete an SSH session if you are a system manager or the user who initiated the session. If **all** is specified then all active SSH sessions are deleted.

Syntax `clear ssh {<1-65535>|all}`

Parameters	Description
<1-65535>	Specify a session ID in the range 1 to 65535 to delete a specific session.
all	Delete all SSH sessions.

Mode Privileged Exec

Examples To stop the current SSH session 123, use the command:

```
awplus# clear ssh 123
```

To stop all SSH sessions active on the device, use the command:

```
awplus# clear ssh all
```

Related commands [service ssh](#)
[ssh](#)

crypto key destroy hostkey

Overview This command deletes the existing public and private keys of the SSH server.

Syntax `crypto key destroy hostkey {dsa|ecdsa|rsa|rsa1}`

Parameters	Description
dsa	Deletes the existing DSA public and private keys.
ecdsa	Deletes the existing ECDSA public and private keys.
rsa	Deletes the existing RSA public and private keys configured for SSH version 2 connections.
rsa1	Deletes the existing RSA public and private keys configured for SSH version 1 connections. From AlliedWare Plus version 5.5.1-1.1 onwards, SSH version 1 is not supported.

Mode Global Configuration

Example To destroy the RSA host key used for SSH version 2 connections, use the commands:

```
awplus# configure terminal
awplus(config)# crypto key destroy hostkey rsa
```

Related commands [crypto key generate hostkey](#)
[service ssh](#)

crypto key destroy userkey

Overview This command destroys the existing public and private keys of an SSH user configured on the device.

Syntax `crypto key destroy userkey <username> {dsa|rsa|rsa1}`

Parameters	Description
<code><username></code>	Name of the user whose userkey you are destroying. The username must begin with a letter. Valid characters are all numbers, letters, and the underscore, hyphen and full stop symbols.
<code>dsa</code>	Deletes the existing DSA userkey.
<code>rsa</code>	Deletes the existing RSA userkey configured for SSH version 2 connections.
<code>rsa1</code>	Deletes the existing RSA userkey for SSH version 1 connections.

Mode Global Configuration

Example To destroy the RSA user key for the SSH user `remoteuser`, use the commands:

```
awplus# configure terminal
awplus(config)# crypto key destroy userkey remoteuser rsa
```

Related commands

- [crypto key generate hostkey](#)
- [show ssh](#)
- [show crypto key hostkey](#)

crypto key generate hostkey

Overview This command generates public and private keys for the SSH server.

When you enable the SSH server, if no host keys exist, the server automatically generates SSHv2 host key pairs using ECDSA with a curve length of 384, and RSA with a 2048-bit key.

If you need a key with different parameters than this, you can use this command to generate that key before you enable the SSH server. If a host key exists with the same cryptography algorithm, this command replaces the old host key with the new key.

This command is not saved in the device configuration. However, the device saves the keys generated by this command in the non-volatile memory.

Syntax `crypto key generate hostkey rsa [<1024-16384>]`
`crypto key generate hostkey ecdsa [<256|384|521>]`

Parameters	Description
rsa	Creates an RSA hostkey.
ecdsa	Creates an ECDSA hostkey.
<1024-16384>	The length in bits of the generated key.
<256 384 521>	The ECDSA key size in bits.

Default The default key length for RSA is 2048 bits.

The default key size for ECDSA is 384 bits.

Mode Global Configuration

Examples To generate an RSA host key that is 4096 bits in length, use the commands:

```
awplus# configure terminal
awplus(config)# crypto key generate hostkey rsa 4096
```

To generate an ECDSA host key with an elliptic curve size of 521 bits, use the commands:

```
awplus# configure terminal
awplus(config)# crypto key generate hostkey ecdsa 521
```

Related commands [crypto key destroy hostkey](#)
[service ssh](#)
[show crypto key hostkey](#)

Command changes Version 5.5.2-0.1: changes to key length and key size ranges and defaults

Version 5.5.1-1.1: support removed for the ssh-rsa algorithm in OpenSSH and for SSH protocol v1

crypto key generate userkey

Overview This command generates public and private keys for an SSH user using either an RSA or ECDSA cryptography algorithm. To use public key authentication, copy the public key of the user onto the remote SSH server.

This command is not saved in the device configuration. However, the device saves the keys generated by this command in the non-volatile memory.

Syntax `crypto key generate userkey <username> rsa [<1024-16384>]`
`crypto key generate userkey <username> ecdsa [<256|384|521>]`

Parameters	Description
<username>	Name of the user that the user key is generated for. The username must begin with a letter. Valid characters are all numbers, letters, and the underscore, hyphen and full stop symbols.
rsa	Creates an RSA userkey for SSH version 2 connections.
ecdsa	Creates an ECDSA hostkey. Both SSH version 1 and 2 connections can use the ECDSA hostkey.
<1024-16384>	The length in bits of the generated key. The default is 2048 bits.
<256 384 521>	The ECDSA key size in bits. The default is 384.

Default The default key length for RSA is 2048 bits.
The default key size for ECDSA is 384 bits.

Mode Global Configuration

Examples To generate a 4096-bit RSA user key for SSH version 2 connections for the user 'bob', use the commands:

```
awplus# configure terminal  
awplus(config)# crypto key generate userkey bob rsa 4096
```

To generate an ECDSA user key of key size 521 for the user 'lapo', use the commands:

```
awplus# configure terminal  
awplus(config)# crypto key generate userkey lapo ecdsa 521
```

Related commands [crypto key pubkey-chain userkey](#)
[show crypto key userkey](#)

Command changes Version 5.5.2-0.1: changes to key length and key size ranges and defaults
Version 5.5.1-1.1: support removed for the ssh-rsa algorithm in OpenSSH and for SSH protocol v1

crypto key pubkey-chain knownhosts

Overview This command adds a public key of the specified SSH server to the known host database on your device. The SSH client on your device uses this public key to verify the remote SSH server.

The key is retrieved from the server. Before adding a key to this database, check that the key sent to you is correct.

If the server's key changes, or if your SSH client does not have the public key of the remote SSH server, then your SSH client will inform you that the public key of the server is unknown or altered.

The **no** variant of this command deletes the public key of the specified SSH server from the known host database on your device.

Syntax `crypto key pubkey-chain knownhosts [ip|ipv6] <hostname> [ecdsa|rsa]`
`no crypto key pubkey-chain knownhosts <1-65535>`

Syntax (VRF-lite) `crypto key pubkey-chain knownhosts [vrf <vrf-name>] [ip|ipv6] <hostname> [ecdsa|rsa]`
`no crypto key pubkey-chain knownhosts [vrf <vrf-name>] <1-65535>`

Parameter	Description
vrf	Apply this command to the specified VRF instance.
<vrf-name>	The VRF instance name
ip	Keyword used prior to specifying an IPv4 address
ipv6	Keyword used prior to specifying an IPv6 address
<hostname>	IPv4/IPv6 address or hostname of a remote server in the format a.b.c.d for an IPv4 address, or in the format x:x::x:x for an IPv6 address.
ecdsa	Specify the ECDSA public key of the server to be added to the known host database.
rsa	Specify the RSA public key of the server to be added to the known host database.
<1-65535>	Specify a key identifier when removing a key using the no parameter.

Default If no cryptography algorithm is specified, then **rsa** is used as the default cryptography algorithm.

Mode Privilege Exec

Usage notes This command adds a public key of the specified SSH server to the known host database on the device. The key is retrieved from the server. The remote SSH server is verified by using this public key. The user is requested to check the key is correct before adding it to the database.

If the remote server's host key is changed, or if the device does not have the public key of the remote server, then SSH clients will inform the user that the public key of the server is altered or unknown.

Examples To add the RSA host key of the remote SSH host IPv4 address 192.0.2.11 to the known host database, use the command:

```
awplus# crypto key pubkey-chain knownhosts 192.0.2.11
```

To delete the second entry in the known host database, use the command:

```
awplus# no crypto key pubkey-chain knownhosts 2
```

Examples (VRF-lite) To add the RSA host key of the remote SSH host IPv4 address 192.0.2.11 in VRF 'red' to the known host database, use the command:

```
awplus# crypto key pubkey-chain knownhosts vrf red 192.0.2.11
```

To delete the second entry in the known host database in VRF 'red', use the command:

```
awplus# no crypto key pubkey-chain knownhosts vrf red 2
```

Validation Commands [show crypto key pubkey-chain knownhosts](#)

Command changes Version 5.4.6-2.1: VRF-lite support added.

crypto key pubkey-chain userkey

Overview This command adds a public key for an SSH user on the SSH server. This allows the SSH server to support public key authentication for the SSH user. When configured, the SSH user can access the SSH server without providing a password from the remote host.

The **no** variant of this command removes a public key for the specified SSH user that has been added to the public key chain. When a SSH user's public key is removed, the SSH user can no longer login using public key authentication.

Syntax `crypto key pubkey-chain userkey <username> [<filename>]`
`no crypto key pubkey-chain userkey <username> <1-65535>`

Parameters	Description
<username>	Name of the user that the SSH server associates the key with. The username must begin with a letter. Valid characters are all numbers, letters, and the underscore, hyphen and full stop symbols. Default: no default
<filename>	Filename of a key saved in flash. Valid characters are any printable character. You can add a key as a hexadecimal string directly into the terminal if you do not specify a filename.
<1-65535>	The key ID number of the user's key. Specify the key ID to delete a key.

Mode Global Configuration

Usage notes You should import the public key file from the client node. The device can read the data from a file on the flash or user terminal.

Or you can add a key as text into the terminal. To add a key as text into the terminal, first enter the command **crypto key pubkey-chain userkey <username>**, and hit [Enter]. Enter the key as text. Note that the key you enter as text must be a valid SSH RSA key, not random ASCII text. Use [Ctrl]+D after entering it to save the text and re-enter the normal command line mode.

Note you can generate a valid SSH RSA key on the device first using the **crypto key generate host rsa** command. View the SSH RSA key generated on the device using the **show crypto hostkey rsa** command. Copy and paste the displayed SSH RSA key after entering the **crypto key pubkey-chain userkey <username>** command. Use [Ctrl]+D after entering it to save it.

Examples To generate a valid SSH RSA key on the device and add the key, use the following commands:

```
awplus# configure terminal
awplus(config)# crypto key generate host rsa
awplus(config)# exit

awplus# show crypto key hostkey
rsaAAAAB3NzaC1yc2EAAAABIwAAAIEAr1s7SokW5aW2fcOw1TStpb9J20bWluhnUC768EoWhyPW6FZ2t5360O5M29EpKBmGq1kQaz5V0mU9IQe66+5YyD4UxOKSDtTI+7jtjDcoGWHb2u4sFwRpXwJZcgYrXW16+6NvNbk+h+c/pqGDijj4SvfZZfeITzvvyZW4/I4pbN8=

awplus# configure terminal
awplus(config)# crypto key pubkey-chain userkey joeType CNTRL/D
to
finish:AAAAB3NzaC1yc2EAAAABIwAAAIEAr1s7SokW5aW2fcOw1TStpb9J20bWluhnUC768EoWhyPW6FZ2t5360O5M29EpKBmGq1kQaz5V0mU9IQe66+5YyD4UxOKSDtTI+7jtjDcoGWHb2u4sFwRpXwJZcgYrXW16+6NvNbk+h+c/pqGDijj4SvfZZfeITzvvyZW4/I4pbN8=control-D

awplus(config)#
```

To add a public key for the user `graydon` from the file `key.pub`, use the commands:

```
awplus# configure terminal
awplus(config)# crypto key pubkey-chain userkey graydon key.pub
```

To add a public key for the user `tamara` from the terminal, use the commands:

```
awplus# configure terminal
awplus(config)# crypto key pubkey-chain userkey tamara
```

and enter the key. Use Ctrl+D to finish.

To remove the first key entry from the public key chain of the user `john`, use the commands:

```
awplus# configure terminal
awplus(config)# no crypto key pubkey-chain userkey john 1
```

Related commands [show crypto key pubkey-chain userkey](#)

debug ssh client

Overview This command enables the SSH client debugging facility. When enabled, any SSH, SCP and SFTP client sessions send diagnostic messages to the login terminal.

The **no** variant of this command disables the SSH client debugging facility. This stops the SSH client from generating diagnostic debugging message.

Syntax `debug ssh client [brief|full]`
`no debug ssh client`

Parameter	Description
brief	Enables brief debug mode.
full	Enables full debug mode.

Default SSH client debugging is disabled by default.

Mode Privileged Exec and Global Configuration

Examples To start SSH client debugging, use the command:

```
awplus# debug ssh client
```

To start SSH client debugging with extended output, use the command:

```
awplus# debug ssh client full
```

To disable SSH client debugging, use the command:

```
awplus# no debug ssh client
```

Related commands [debug ssh server](#)
[show ssh client](#)
[undebug ssh client](#)

debug ssh server

Overview This command enables the SSH server debugging facility. When enabled, the SSH server sends diagnostic messages to the system log. To display the debugging messages on the terminal, use the **terminal monitor** command.

The **no** variant of this command disables the SSH server debugging facility. This stops the SSH server from generating diagnostic debugging messages.

Syntax `debug ssh server [brief|full]`
`no debug ssh server`

Parameter	Description
brief	Enables brief debug mode.
full	Enables full debug mode.

Default SSH server debugging is disabled by default.

Mode Privileged Exec and Global Configuration

Examples To start SSH server debugging, use the command:

```
awplus# debug ssh server
```

To start SSH server debugging with extended output, use the command:

```
awplus# debug ssh server full
```

To disable SSH server debugging, use the command:

```
awplus# no debug ssh server
```

Related commands [debug ssh client](#)
[show ssh server](#)
[undebug ssh server](#)

service ssh

Overview Use this command to enable the Secure Shell server on the device. Once enabled, connections coming from SSH clients are accepted.

When you enable the SSH server, if no host keys exist, the server automatically generates SSHv2 host key pairs using ECDSA with a curve length of 384, and RSA with a 1024-bit key.

If you need a key with different parameters than this, you can use the [crypto key generate hostkey](#) command to generate that key before you enable the SSH server.

Use the **no** variant of this command to disable the Secure Shell server. When the Secure Shell server is disabled, connections from SSH, SCP, and SFTP clients are not accepted. This command does not affect existing SSH sessions. To terminate existing sessions, use the [clear ssh](#) command.

Syntax `service ssh [ip|ipv6]`
`no service ssh [ip|ipv6]`

Default The Secure Shell server is disabled by default. Both IPv4 and IPv6 Secure Shell server are enabled when you issue **service ssh** without specifying the optional **ip** or **ipv6** parameters.

Mode Global Configuration

Examples To enable both the IPv4 and the IPv6 Secure Shell server, use the commands:

```
awplus# configure terminal
awplus(config)# service ssh
```

To enable the IPv4 Secure Shell server only, use the commands:

```
awplus# configure terminal
awplus(config)# service ssh ip
```

To enable the IPv6 Secure Shell server only, use the commands:

```
awplus# configure terminal
awplus(config)# service ssh ipv6
```

To disable both the IPv4 and the IPv6 Secure Shell server, use the commands:

```
awplus# configure terminal
awplus(config)# no service ssh
```

To disable the IPv4 Secure Shell server only, use the commands:

```
awplus# configure terminal
awplus(config)# no service ssh ip
```

To disable the IPv6 Secure Shell server only, use the commands:

```
awplus# configure terminal  
awplus(config)# no service ssh ipv6
```

**Related
commands**

[crypto key generate hostkey](#)
[show running-config ssh](#)
[show ssh server](#)
[ssh server allow-users](#)
[ssh server deny-users](#)

**Command
changes**

Version 5.5.1-1.1: support removed for the ssh-rsa algorithm in OpenSSH and for SSH protocol v1

show banner login

Overview This command displays the banner message configured on the device. The banner message is displayed to the remote user before user authentication starts.

Syntax `show banner login`

Mode User Exec, Privileged Exec, Global Configuration, Interface Configuration, Line Configuration

Example To display the current login banner message, use the command:

```
awplus# show banner login
```

Related commands [banner login \(SSH\)](#)

show crypto key hostkey

Overview This command displays the public keys generated on the device for the SSH server.

When you enable the SSH server, if no host keys exist, the server automatically generates SSHv2 host key pairs using ECDSA with a curve length of 384, and RSA with a 1024-bit key.

The private key remains on the device secretly. The public key is copied to SSH clients to identify the server. This command displays the public key.

Syntax `show crypto key hostkey [dsa|ecdsa|rsa|rsa1]`

Parameter	Description
dsa	Displays the DSA algorithm public key.
ecdsa	Displays the ECDSA algorithm public key.
rsa	Displays the RSA algorithm public key for SSH version 2 connections.
rsa1	Displays the RSA algorithm public key for SSH version 1 connections. From AlliedWare Plus 5.5.1-1.1 onwards, SSH version 1 is not supported.

Mode User Exec, Privileged Exec and Global Configuration

Examples To show the public keys generated on the device for SSH server, use the command:

```
awplus# show crypto key hostkey
```

To display the RSA public key of the SSH server, use the command:

```
awplus# show crypto key hostkey rsa
```

Output Figure 61-1: Example output from the **show crypto key hostkey** command

```
Type Bits Fingerprint
-----
rsa 1024 SHA256:T/sVz5OoA1HHXcov9dXzGGQg8avRUYh1psxNSUcSOvs
ecdsa 384 SHA256:qVn/KpN5X5ct5CJakxE40mPWmPvW2vIbBjF4SA2bZkM
```

Table 1: Parameters in output of the **show crypto key hostkey** command

Parameter	Description
Type	Algorithm used to generate the key.
Bits	Length in bits of the key.
Fingerprint	Checksum value for the public key.

Related commands [crypto key destroy hostkey](#)
[crypto key generate hostkey](#)

show crypto key pubkey-chain knownhosts

Overview This command displays the list of public keys maintained in the known host database on the device.

Syntax `show crypto key pubkey-chain knownhosts [<1-65535>]`

Syntax (VRF-lite) `show crypto key pubkey-chain knownhosts [vrf <vrf-name> | global] [<1-65535>]`

Parameter	Description
global	When VRF-lite is configured, apply the command to the global routing and forwarding table.
vrf	Apply the command to the specified VRF instance.
<i><vrf-name></i>	The name of the VRF instance.
<i><1-65535></i>	Key identifier for a specific key. Displays the public key of the entry if specified.

Default Display all keys.

Mode User Exec, Privileged Exec and Global Configuration

Usage When VRF-lite is configured:

- If **vrf** is specified, this command displays the known host database from the specified VRF instance.
- If **global** is specified, this command displays the known host database from the global routing environment.
- If neither **vrf** nor **global** is specified, this command displays the known host database from the global routing environment and each configured VRF.

For more information about VRF, see the [VRF Lite Feature Overview and Configuration Guide](#).

Examples To display public keys of known SSH servers, use the command:

```
awplus# show crypto key pubkey-chain knownhosts
```

To display the key data of the first entry in the known host data, use the command:

```
awplus# show crypto key pubkey-chain knownhosts 1
```

Output Figure 61-2: Example output from the **show crypto key public-chain knownhosts** command

No	Hostname	Type	Fingerprint
1	172.16.23.1	rsa	c8:33:b1:fe:6f:d3:8c:81:4e:f7:2a:aa:a5:be:df:18
2	172.16.23.10	rsa	c4:79:86:65:ee:a0:1d:a5:6a:e8:fd:1d:d3:4e:37:bd
3	5ffe:1053:ac21:ff00:0101:bcdf:ffff:0001	rsal	af:4e:b4:a2:26:24:6d:65:20:32:d9:6f:32:06:ba:57

Table 2: Parameters in the output of the **show crypto key public-chain knownhosts** command

Parameter	Description
No	Number ID of the key.
Hostname	Host name of the known SSH server.
Type	The algorithm used to generate the key.
Fingerprint	Checksum value for the public key.

Related commands [crypto key pubkey-chain knownhosts](#)

Command changes Version 5.4.6-2.1: VRF-lite support added.

show crypto key pubkey-chain userkey

Overview This command displays the public keys registered with the SSH server for SSH users. These keys allow remote users to access the device using public key authentication. By using public key authentication, users can access the SSH server without providing password.

Syntax `show crypto key pubkey-chain userkey <username> [<1-65535>]`

Parameter	Description
<username>	User name of the remote SSH user whose keys you wish to display. The username must begin with a letter. Valid characters are all numbers, letters, and the underscore, hyphen and full stop symbols.
<1-65535>	Key identifier for a specific key.

Default Display all keys.

Mode User Exec, Privileged Exec and Global Configuration

Example To display the public keys for the user `manager` that are registered with the SSH server, use the command:

```
awplus# show crypto key pubkey-chain userkey manager
```

Output Figure 61-3: Example output from the **show crypto key public-chain userkey** command

No	Type	Bits	Fingerprint
1	dsa	1024	2b:cc:df:a8:f8:2e:8f:a4:a5:4f:32:ea:67:29:78:fd
2	rsa	2048	6a:ba:22:84:c1:26:42:57:2c:d7:85:c8:06:32:49:0e

Table 3: Parameters in the output of the **show crypto key userkey** command

Parameter	Description
No	Number ID of the key.
Type	The algorithm used to generate the key.
Bits	Length in bits of the key.
Fingerprint	Checksum value for the key.

Related commands [crypto key pubkey-chain userkey](#)

show crypto key userkey

Overview This command displays the public keys created on this device for the specified SSH user.

Syntax `show crypto key userkey <username> [dsa|rsa|rsa1]`

Parameter	Description
<username>	User name of the local SSH user whose keys you wish to display. The username must begin with a letter. Valid characters are all numbers, letters, and the underscore, hyphen and full stop symbols.
dsa	Displays the DSA public key.
rsa	Displays the RSA public key used for SSH version 2 connections.
rsa1	Displays the RSA key used for SSH version 1 connections.

Mode User Exec, Privileged Exec and Global Configuration

Examples To show the public key generated for the user, use the command:

```
awplus# show crypto key userkey manager
```

To store the RSA public key generated for the user manager to the file "user.pub", use the command:

```
awplus# show crypto key userkey manager rsa > manager-rsa.pub
```

Output Figure 61-4: Example output from the **show crypto key userkey** command

Type	Bits	Fingerprint
rsa	2048	e8:d6:1b:c0:f4:b6:e6:7d:02:2e:a9:d4:a1:ca:3b:11
rsa1	1024	12:25:60:95:64:08:8e:a1:8c:3c:45:1b:44:b9:33:9b

Table 4: Parameters in the output of the **show crypto key userkey** command

Parameter	Description
Type	The algorithm used to generate the key.
Bits	Length in bits of the key.
Fingerprint	Checksum value for the key.

Related commands [crypto key generate userkey](#)

show running-config ssh

Overview This command displays the current running configuration of Secure Shell (SSH).

Syntax `show running-config ssh`

Mode Privileged Exec and Global Configuration

Example To display the current configuration of SSH, use the command:

```
awplus# show running-config ssh
```

Output Figure 61-5: Example output from the **show running-config ssh** command

```
!  
ssh server session-timeout 600  
ssh server login-timeout 30  
ssh server allow-users manager 192.168.1.*  
ssh server allow-users john  
ssh server deny-user john*.a-company.com  
ssh server
```

Table 5: Parameters in the output of the **show running-config ssh** command

Parameter	Description
<code>ssh server</code>	SSH server is enabled.
<code>ssh server v2</code>	SSH server is enabled and only support SSHv2.
<code>ssh server<port></code>	SSH server is enabled and listening on the specified TCP port.
<code>no ssh server scp</code>	SCP service is disabled.
<code>no ssh server sftp</code>	SFTP service is disabled.
<code>ssh server session-timeout</code>	Configure the server session timeout.
<code>ssh server login-timeout</code>	Configure the server login timeout.
<code>ssh server max-startups</code>	Configure the maximum number of concurrent sessions waiting authentication.
<code>no ssh server authentication password</code>	Password authentication is disabled.
<code>no ssh server authentication publickey</code>	Public key authentication is disabled.

Table 5: Parameters in the output of the **show running-config ssh** command

Parameter	Description
ssh server allow-users	Add the user (and hostname) to the allow list.
ssh server deny-users	Add the user (and hostname) to the deny list.

Related commands

- [service ssh](#)
- [show ssh server](#)

show ssh

Overview This command displays the active SSH sessions on the device, both incoming and outgoing.

Syntax `show ssh`

Mode User Exec, Privileged Exec and Global Configuration

Example To display the current SSH sessions on the device, use the command:

```
awplus# show ssh
```

Output Figure 61-6: Example output from the **show ssh** command

```
Secure Shell Sessions:
ID  Type  Mode   Peer Host      Username      State      Filename
-----
414 ssh   server 172.16.23.1   root         open
456 ssh   client 172.16.23.10 manager      user-auth
459 scp   client 172.16.23.12 root         download   example.awd
463 ssh   client 5ffe:33fe:5632:ffbb:bc35:ddee:0101:ac51
                                manager      user-auth
```

Table 6: Parameters in the output of the **show ssh** command

Parameter	Description
ID	Unique identifier for each SSH session.
Type	Session type; either SSH, SCP, or SFTP.
Mode	Whether the device is acting as an SSH client (client) or SSH server (server) for the specified session.
Peer Host	The hostname or IP address of the remote server or client.
Username	Login user name of the server.

Table 6: Parameters in the output of the **show ssh** command (cont.)

Parameter	Description	
State	The current state of the SSH session. One of:	
	connecting	The device is looking for a remote server.
	connected	The device is connected to the remote server.
	accepted	The device has accepted a new session.
	host-auth	host-to-host authentication is in progress.
	user-auth	User authentication is in progress.
	authenticated	User authentication is complete.
	open	The session is in progress.
	download	The user is downloading a file from the device.
	upload	The user is uploading a file from the device.
	closing	The user is terminating the session.
	closed	The session is closed.
Filename	Local filename of the file that the user is downloading or uploading.	

Related commands [clear ssh](#)

show ssh client

Overview This command displays the current configuration of the Secure Shell client.

Syntax `show ssh client`

Mode User Exec, Privileged Exec and Global Configuration

Example To display the current configuration for SSH clients on the login shell, use the command:

```
awplus# show ssh client
```

Output Figure 61-7: Example output from the **show ssh client** command

```
Secure Shell Client Configuration
-----
Port                               : 22
Version                             : 2,1
Connect Timeout                     : 30 seconds
Session Timeout                     : 0 (off)
Debug                               : NONE
```

Table 7: Parameters in the output of the **show ssh client** command

Parameter	Description
Port	SSH server TCP port where the SSH client connects to. The default is port 22.
Version	SSH server version, either "2" or "2,1". From AlliedWare Plus 5.5.1-1.1 onwards, SSH version 1 is not supported.
Connect Timeout	Time in seconds that the SSH client waits for an SSH session to establish. If the value is 0, the connection is terminated when it reaches the TCP timeout.
Debug	Whether debugging is active on the client.

Related commands [show ssh server](#)

show ssh server

Overview This command displays the current configuration of the Secure Shell server.

Note that changes to the SSH configuration affects only new SSH sessions coming from remote hosts, and does not affect existing sessions.

Syntax `show ssh server`

Mode User Exec, Privileged Exec, and Global Configuration

Example To display the current configuration of the Secure Shell server, use the command:

```
awplus# show ssh server
```

Output Figure 61-8: Example output from the **show ssh server** command

```
Secure Shell Server Configuration
-----
SSH Server           : Enabled
Protocol            : IPv4,IPv6
Port                : 22
Version             : 2
Services            : scp, sftp
User Authentication : publickey, password
Resolve Hosts       : Disabled
Session Timeout     : 0 (Off)
Login Timeout       : 60 seconds
Maximum Authentication Tries : 6
Maximum Startups    : 10
Debug               : NONE
Ciphers             : aes128-cbc,aes128-ctr,aes192-ctr,aes256-ctr
KEX                 : curve25519-sha256@libssh.org,
                    ecdh-sha2-nistp256,ecdh-sha2-nistp384,
                    ecdh-sha2-nistp521,
                    diffie-hellman-group-exchange-sha256,
                    diffie-hellman-group-exchange-sha1,
                    diffie-hellman-group14-sha1
```

Table 8: Parameters in the output of the **show ssh server** command

Parameter	Description
SSH Server	Whether the Secure Shell server is enabled or disabled.
Port	TCP port where the Secure Shell server listens for connections. The default is port 22.
Version	SSH server version; either '2' or '2,1'. From AlliedWare Plus 5.5.1-1.1 onwards, SSH version 1 is not supported.
Services	List of the available Secure Shell services; one or more of SHELL, SCP or SFTP.

Table 8: Parameters in the output of the **show ssh server** command (cont.)

Parameter	Description
User Authentication	List of available authentication methods.
Login Timeout	Time (in seconds) that the SSH server will wait the SSH session to establish. If the value is 0, the client login will be terminated when TCP timeout reaches.
Idle Timeout	Time (in seconds) that the SSH server will wait to receive data from the SSH client. The server disconnects if this timer limit is reached. If set at 0, the idle timer remains off.
Maximum Startups	The maximum number of concurrent connections that are waiting authentication. The default is 10.
Debug	Whether debugging is active on the server.
Ciphers	List of ciphers permitted.
KEX	List of available Key Exchange algorithms.

Related commands [show ssh](#)
[show ssh client](#)

show ssh server allow-users

Overview This command displays the user entries in the allow list of the SSH server.

Syntax `show ssh server allow-users`

Mode User Exec, Privileged Exec and Global Configuration

Example To display the user entries in the allow list of the SSH server, use the command:

```
awplus# show ssh server allow-users
```

Output Figure 61-9: Example output from the **show ssh server allow-users** command

Username	Remote Hostname (pattern)
awplus	192.168.*
john	
manager	*.alliedtelesis.com

Table 9: Parameters in the output of the **show ssh server allow-users** command

Parameter	Description
Username	User name that is allowed to access the SSH server.
Remote Hostname (pattern)	IP address or hostname pattern of the remote client. The user is allowed requests from a host that matches this pattern. If no hostname is specified, the user is allowed from all hosts.

Related commands [ssh server allow-users](#)
[ssh server deny-users](#)

show ssh server deny-users

Overview This command displays the user entries in the deny list of the SSH server. The user in the deny list is rejected to access the SSH server. If a user is not included in the access list of the SSH server, the user is also rejected.

Syntax `show ssh server deny-users`

Mode User Exec, Privileged Exec and Global Configuration

Example To display the user entries in the deny list of the SSH server, use the command:

```
awplus# show ssh server deny-users
```

Output Figure 61-10: Example output from the **show ssh server deny-users** command

Username	Remote Hostname (pattern)
john	*.b-company.com
manager	192.168.2.*

Table 10: Parameters in the output of the **show ssh server deny-user** command

Parameter	Description
Username	The user that this rule applies to.
Remote Hostname (pattern)	IP address or hostname pattern of the remote client. The user is denied requests from a host that matches this pattern. If no hostname is specified, the user is denied from all hosts.

Related commands [ssh server allow-users](#)
[ssh server deny-users](#)

ssh

Overview Use this command to initiate a Secure Shell connection to a remote SSH server.

If the server requests a password to login, you need to type in the correct password at the "Password:" prompt.

An SSH client identifies the remote SSH server by its public key registered on the client device. If the server identification is changed, server verification fails. If the public key of the server has been changed, the public key of the server must be explicitly added to the known host database.

NOTE: A hostname specified with SSH cannot begin with a hyphen (-) character.

Syntax `ssh [ip|ipv6] [user <username>|port <1-65535>|version 2] <remote-device> [<command>]`

Syntax (VRF-lite) `ssh vrf <vrf-name> [ip|ipv6] [user <username>|port <1-65535>|version 2] <remote-device> [<command>]`

Parameter	Description
vrf	Apply the command to the specified VRF instance. When using VRF, specifying a VRF name means the command will apply to that VRF instance, and not specifying a VRF name means the command will apply to the global VRF.
<vrf-name>	The name of the VRF instance.
ip	Specify IPv4 SSH.
ipv6	Specify IPv6 SSH.
user	Login user. If user is specified, the username is used for login to the remote SSH server when user authentication is required. Otherwise the current user name is used. <username> User name to login on the remote server.
port	SSH server port. If port is specified, the SSH client connects to the remote SSH server with the specified TCP port. Otherwise, the client port configured by "ssh client" command or the default TCP port (22) is used. <1-65535> TCP port.
version	SSH client version. From 5.5.1-1.1 onwards, SSH only supports version 2.
<remote-device>	IPv4/IPv6 address or hostname of a remote server. The address is in the format A.B.C.D for an IPv4 address, or in the format X:X::X:X for an IPv6 address. Note that a hostname specified with SSH cannot begin with a hyphen (-) character.
<command>	A command to execute on the remote server. If a command is specified, the command is executed on the remote SSH server and the session is disconnected when the remote command finishes.

Mode User Exec and Privileged Exec

Examples To login to the remote SSH server at 192.0.2.5, use the command:

```
awplus# ssh ip 192.0.2.5
```

To login to the remote SSH server at 192.0.2.5 as user 'manager', use the command:

```
awplus# ssh ip user manager 192.0.2.5
```

To login to the remote SSH server at 192.0.2.5 that is listening on TCP port 2000, use the command:

```
awplus# ssh port 2000 192.0.2.5
```

To login to the remote SSH server 'example_host' using an IPv6 session, use the command:

```
awplus# ssh ipv6 example_host
```

To run the **cmd** command on the remote SSH server at 192.0.2.5, use the command:

```
awplus# ssh ip 192.0.2.5 cmd
```

Example (VRF-lite) To login to the remote SSH server at 192.168.1.1 on VRF "red", use the command:

```
awplus# ssh vrf red 192.168.1.1
```

Related commands

- [crypto key generate userkey](#)
- [crypto key pubkey-chain knownhosts](#)
- [debug ssh client](#)
- [ssh client](#)

Command changes

- Version 5.4.6-2.1: VRF-lite support added for AR-Series devices.
- Version 5.4.8-1.2: secure mode syntax added for x220, x930, x550, XS900MX.
- Version 5.4.8-2.1: secure mode syntax added for x950, SBx908 GEN2.
- Version 5.5.1-1.1: support removed for SSH protocol v1

ssh client

Overview This command modifies the default configuration parameters of the Secure Shell (SSH) client. The configuration is used for any SSH client on the device to connect to remote SSH servers. Any parameters specified on SSH client explicitly override the default configuration parameters.

The change affects the current user shell only. When the user exits the login session, the configuration does not persist. This command does not affect existing SSH sessions.

The **no** variant of this command resets configuration parameters of the Secure Shell (SSH) client changed by the `ssh client` command, and restores the defaults.

This command does not affect the existing SSH sessions.

Syntax

```
ssh client {port <1-65535>|version 2|session-timeout <0-3600>|connect-timeout <1-600>}
no ssh client {port|version|session-timeout|connect-timeout}
```

Syntax (VRF-lite)

```
ssh client {port <1-65535>|version 2|session-timeout <0-3600>|connect-timeout <1-600>|vrf <vrf-name>}
no ssh client
{port|version|session-timeout|connect-timeout|vrf}
```

Parameter	Description
port	The default TCP port of the remote SSH server. If an SSH client specifies an explicit port of the server, it overrides the default TCP port. Default: 22 <1-65535> TCP port number.
version	The SSH version used by the client for SSH sessions. From 5.5.1-1.1 onwards, the SSH client supports only version 2
session-timeout	The global session timeout for SSH sessions. If the session timer lapses since the last time an SSH client received data from the remote server, the session is terminated. If the value is 0, then the client does not terminate the session. Instead, the connection is terminated when it reaches the TCP timeout. Default: 0 (session timer remains off) <0-3600> Timeout in seconds.
connect-timeout	The maximum time period that an SSH session can take to become established. The SSH client terminates the SSH session if this timeout expires and the session is still not established. Default: 30 <1-600> Timeout in seconds.
vrf <vrf-name>	The VRF to use for SSH clients. Default: the global VRF.

Mode Privileged Exec

Examples To configure the default TCP port for SSH clients to 2200, and the session timer to 10 minutes, use the command:

```
awplus# ssh client port 2200 session-timeout 600
```

To configure the connect timeout of SSH client to 10 seconds, use the command:

```
awplus# ssh client connect-timeout 10
```

To restore the connect timeout to its default, use the command:

```
awplus# no ssh client connect-timeout
```

Example (VRF-lite) To configure SSH clients to use the VRF named 'red', use the command:

```
awplus# ssh client vrf red
```

Related commands [show ssh client](#)
[ssh](#)

Command changes Version 5.5.2-1.1: **vrf** parameter added for products that support VRF
Version 5.5.1-1.1: support removed for the ssh-rsa algorithm in OpenSSH and for SSH protocol v1

ssh server

Overview Use this command to modify the configuration of the SSH server. Changing these parameters affects new SSH sessions connecting to the device.

Use the **no** variant of this command to restore the configuration of a specified parameter to its default. The change affects the SSH server immediately if the server is running. Otherwise, the configuration is used when the server starts.

To enable the SSH server, use the [service ssh](#) command.

Syntax

```
ssh server <1-65535>  
ssh server {[session-timeout <0-3600>] [login-timeout <1-600>]  
[max-startups <1-128>]}  
no ssh server {[session-timeout] [login-timeout]  
[max-startups]}
```

Parameter	Description
<1-65535>	The TCP port number that the server listens to for incoming SSH sessions. Default: 22
session-timeout	The maximum time period that the server waits before deciding that a session is inactive and should be terminated. The server considers the session inactive when it has not received any data from the client, and when the client does not respond to keep alive messages. Default: 0 (session timer remains off). Enter a timeout between 0-3600 seconds.
login-timeout	The maximum time period the server waits before disconnecting an unauthenticated client. Default: 60 Enter a timeout between 1- 600 seconds.
max-startups	The maximum number of concurrent unauthenticated connections the server accepts. When the number of SSH connections awaiting authentication reaches the limit, the server drops any additional connections until authentication succeeds or the login timer expires for a connection. Default: 10 Enter a number of sessions in the range of 1-128.

Mode Global Configuration

Examples To set the session timer of the SSH server to 10 minutes (600 seconds), use the commands:

```
awplus# configure terminal  
awplus(config)# ssh server session-timeout 600
```

To set the login timeout of the SSH server to 30 seconds, use the commands:

```
awplus# configure terminal
awplus(config)# ssh server login-timeout 30
```

To limit the number of SSH client connections waiting for authentication from the SSH server to 3, use the commands:

```
awplus# configure terminal
awplus(config)# ssh server max-startups 3
```

To return the limit on the number of waiting connections to the default of 10, use the commands:

```
awplus# configure terminal
awplus(config)# no ssh server max-startups
```

To support the SSH server with TCP port 2200, use the commands:

```
awplus# configure terminal
awplus(config)# ssh server 2200
```

Related commands

- [show ssh server](#)
- [ssh client](#)
- [ssh server vrf](#)

Command changes Version 5.5.1-1.1: support removed for the ssh-rsa algorithm in OpenSSH and for SSH protocol v1

ssh server vrf

Overview Use this command to specify a VRF for the SSH server to operate within.
Use the **no** variant of this command to return the SSH server to the default VRF.

Syntax `ssh server vrf [<vrf-name>]`
`no ssh server vrf`

Parameter	Description
<vrf-name>	The name of the VRF instance

Default The global VRF

Mode Global Configuration

Example To configure the SSH server to operate within the VRF instance named 'red', use the command:

```
awplus# configure terminal
awplus(config)# ssh server vrf red
```

To return the SSH server to operating within the global VRF instance, use the command:

```
awplus# configure terminal
awplus(config)# no ssh server vrf
```

Related commands [show ssh server](#)
[ssh](#)
[ssh server](#)

Command changes Version 5.5.2-1.1: command added

ssh server allow-users

Overview This command adds a username pattern to the allow list of the SSH server. If the user of an incoming SSH session matches the pattern, the session is accepted.

When there are no registered users in the server's database of allowed users, the SSH server does not accept SSH sessions even when enabled.

SSH server also maintains the deny list. The server checks the user in the deny list first. If a user is listed in the deny list, then the user access is denied even if the user is listed in the allow list.

The **no** variant of this command deletes a username pattern from the allow list of the SSH server. To delete an entry from the allow list, the username and hostname pattern should match exactly with the existing entry.

Syntax `ssh server allow-users <username-pattern> [<hostname-pattern>]`
`no ssh server allow-users <username-pattern>`
 `[<hostname-pattern>]`

Parameter	Description
<code><username-pattern></code>	The username pattern that users can match to. An asterisk acts as a wildcard character that matches any string of characters.
<code><hostname-pattern></code>	The host name pattern that hosts can match to. If specified, the server allows the user to connect only from hosts matching the pattern. An asterisk acts as a wildcard character that matches any string of characters.

Mode Global Configuration

Examples To allow the user `john` to create an SSH session from any host, use the commands:

```
awplus# configure terminal
awplus(config)# ssh server allow-users john
```

To allow the user `john` to create an SSH session from a range of IP address (from 192.168.1.1 to 192.168.1.255), use the commands:

```
awplus# configure terminal
awplus(config)# ssh server allow-users john 192.168.1.*
```

To allow the user `john` to create a SSH session from `a-company.com` domain, use the commands:

```
awplus# configure terminal
awplus(config)# ssh server allow-users john *.a-company.com
```

To delete the existing user entry `john 192.168.1.*` in the allow list, use the commands:

```
awplus# configure terminal
```

```
awplus(config)# no ssh server allow-users john 192.168.1.*
```

Related commands

- [show running-config ssh](#)
- [show ssh server allow-users](#)
- [ssh server deny-users](#)

ssh server authentication

Overview This command enables RSA public-key or password user authentication for SSH Server. Apply the **password** keyword with the **ssh server authentication** command to enable password authentication for users. Apply the **publickey** keyword with the **ssh server authentication** command to enable RSA public-key authentication for users.

Use the **no** variant of this command to disable RSA public-key or password user authentication for SSH Server. Apply the **password** keyword with the **no ssh authentication** command to disable password authentication for users. Apply the required **publickey** keyword with the **no ssh authentication** command to disable RSA public-key authentication for users.

Syntax `ssh server authentication {password|publickey}`
`no ssh server authentication {password|publickey}`

Parameter	Description
<code>password</code>	Specifies user password authentication for SSH server.
<code>publickey</code>	Specifies user publickey authentication for SSH server.

Default Both RSA public-key authentication and password authentication are enabled by default.

Mode Global Configuration

Usage For password authentication to authenticate a user, password authentication for a user must be registered in the local user database or on an external RADIUS server, before using the **ssh server authentication password** command.

For RSA public-key authentication to authenticate a user, a public key must be added for the user, before using the **ssh server authentication publickey** command.

Examples To enable `password` authentication for users connecting through SSH, use the commands:

```
awplus# configure terminal
awplus(config)# ssh server authentication password
```

To enable `publickey` authentication for users connecting through SSH, use the commands:

```
awplus# configure terminal
awplus(config)# ssh server authentication publickey
```

To disable `password` authentication for users connecting through SSH, use the commands:

```
awplus# configure terminal
awplus(config)# no ssh server authentication password
```

To disable `publickey` authentication for users connecting through SSH, use the commands:

```
awplus# configure terminal
awplus(config)# no ssh server authentication publickey
```

**Related
commands**

`crypto key pubkey-chain userkey`
`service ssh`
`show ssh server`

ssh server deny-users

Overview This command adds a username pattern to the deny list of the SSH server. If the user of an incoming SSH session matches the pattern, the session is rejected.

SSH server also maintains the allow list. The server checks the user in the deny list first. If a user is listed in the deny list, then the user access is denied even if the user is listed in the allow list.

If a hostname pattern is specified, the user is denied from the hosts matching the pattern.

The **no** variant of this command deletes a username pattern from the deny list of the SSH server. To delete an entry from the deny list, the username and hostname pattern should match exactly with the existing entry.

Syntax `ssh server deny-users <username-pattern> [<hostname-pattern>]`
`no ssh server deny-users <username-pattern>`
`[<hostname-pattern>]`

Parameter	Description
<code><username-pattern></code>	The username pattern that users can match to. The username must begin with a letter. Valid characters are all numbers, letters, and the underscore, hyphen, full stop and asterisk symbols. An asterisk acts as a wildcard character that matches any string of characters.
<code><hostname-pattern></code>	The host name pattern that hosts can match to. If specified, the server denies the user only when they connect from hosts matching the pattern. An asterisk acts as a wildcard character that matches any string of characters.

Mode Global Configuration

Examples To deny the user `john` to access SSH login from any host, use the commands:

```
awplus# configure terminal
awplus(config)# ssh server deny-users john
```

To deny the user `john` to access SSH login from a range of IP address (from 192.168.2.1 to 192.168.2.255), use the commands:

```
awplus# configure terminal
awplus(config)# ssh server deny-users john 192.168.2.*
```

To deny the user `john` to access SSH login from `b-company.com` domain, use the commands:

```
awplus# configure terminal
awplus(config)# ssh server deny-users john*.b-company.com
```

To delete the existing user entry `john 192.168.2.*` in the deny list, use the commands:

```
awplus# configure terminal
awplus(config)# no ssh server deny-users john 192.168.2.*
```

Related commands

- [show running-config ssh](#)
- [show ssh server deny-users](#)
- [ssh server allow-users](#)

ssh server max-auth-tries

Overview Use this command to specify the maximum number of SSH authentication attempts that the device will allow.

Use the **no** variant of this command to return the maximum number of attempts to its default value of 6.

Syntax `ssh server max-auth-tries <1-32>`
`no ssh server max-auth-tries`

Parameter	Description
<1-32>	Maximum number of SSH authentication attempts the device will allow.

Default 6 attempts

Mode Global Configuration

Usage By default, users must wait one second after a failed login attempt before trying again. You can increase this gap by using the command [aaa login fail-delay](#).

Example To set the maximum number of SSH authentication attempts to 3, use the commands:

```
awplus# configure terminal
awplus(config)# ssh server max-auth-tries 3
```

Related commands [show ssh server](#)

ssh server resolve-host

Overview This command enables resolving an IP address from a host name using a DNS server for client host authentication.

The **no** variant of this command disables this feature.

Syntax `ssh server resolve-hosts`
`no ssh server resolve-hosts`

Default This feature is disabled by default.

Mode Global Configuration

Usage notes Your device has a DNS Client that is enabled automatically when you add a DNS server to your device. Use the [ip name-server](#) command to add a DNS server to the list of servers that the device queries.

Example To resolve a host name using a DNS server, use the commands:

```
awplus# configure terminal
awplus(config)# ssh server resolve-hosts
```

Related commands

- [ip name-server](#)
- [show ssh server](#)
- [ssh server allow-users](#)
- [ssh server deny-users](#)

ssh server scp

Overview This command enables the Secure Copy (SCP) service on the SSH server. Once enabled, the server accepts SCP requests from remote clients.

You must enable the SSH server as well as this service before the device accepts SCP connections. The SCP service is enabled by default as soon as the SSH server is enabled.

The **no** variant of this command disables the SCP service on the SSH server. Once disabled, SCP requests from remote clients are rejected.

Syntax `ssh server scp`
`no ssh server scp`

Mode Global Configuration

Examples To enable the SCP service, use the commands:

```
awplus# configure terminal
awplus(config)# ssh server scp
```

To disable the SCP service, use the commands:

```
awplus# configure terminal
awplus(config)# no ssh server scp
```

Related commands [show running-config ssh](#)
[show ssh server](#)

ssh server secure-algs

Overview Use this command to force the SSH server to only use ciphers, key exchange algorithms and Message Authentication Code (MAC) algorithms that are currently considered best-practice.

This command is the same as using all of the commands [ssh server secure-ciphers](#), [ssh server secure-mac](#), and [ssh server secure-kex](#).

Use the **no** variant of this command to stop forcing the SSH server to use this restricted set of algorithms.

Syntax `ssh server secure-algs`
`no ssh server secure-algs`

Default Disabled.

Mode Global Configuration

Usage notes To see the list of algorithms, use the [show ssh server](#) command.

Example To force the SSH server to use best-practice algorithms, use the commands:

```
awplus# configure terminal
awplus(config)# ssh server secure-algs
```

Related commands [show ssh server](#)
[ssh server](#)
[ssh server secure-ciphers](#)
[ssh server secure-kex](#)
[ssh server secure-mac](#)

Command changes Version 5.5.1-1.1: command added

ssh server secure-ciphers

Overview Use this command to force the SSH server to only negotiate ciphers regarded as current best-practice.

Use the **no** variant of this command to stop forcing the SSH server to use this restricted set of ciphers.

Syntax `ssh server secure-ciphers`
`no ssh server secure-ciphers`

Default Not set

Mode Global Configuration

Usage notes To see the list of ciphers, use the [show ssh server](#) command.

Example To configure the SSH server to use best-practice ciphers, use the commands:

```
awplus# configure terminal
awplus(config)# ssh server secure-ciphers
```

Related commands [show ssh server](#)
[ssh server](#)
[ssh server secure-algs](#)
[ssh server secure-kex](#)
[ssh server secure-mac](#)

Command changes Version 5.5.0-1.1: command added

ssh server secure-kex

Overview Use this command to force the SSH server to only use key exchange algorithms that are currently considered best-practice.

For example, using this command stops the device from using the diffie-hellman-group-exchange-sha1 key exchange algorithm.

Use the **no** variant of this command to stop forcing the SSH server to use this restricted set of key-exchange algorithms.

Syntax `ssh server secure-kex`
`no ssh server secure-kex`

Default Disabled.

Mode Global Configuration

Usage notes To see the list of key exchange algorithms, use the [show ssh server](#) command.

Example To force the SSH server to use best-practice key-exchange algorithms, use the commands:

```
awplus# configure terminal
awplus(config)# ssh server secure-kex
```

Related commands [show ssh server](#)
[ssh server](#)
[ssh server secure-algs](#)
[ssh server secure-ciphers](#)
[ssh server secure-mac](#)

Command changes Version 5.5.0-2.3: command added

ssh server secure-mac

Overview Use this command to force the SSH server to only use Message Authentication Code (MAC) algorithms that are currently considered best-practice.

Use the **no** variant of this command to stop forcing the SSH server to use this restricted set of MAC algorithms.

Syntax `ssh server secure-mac`
`no ssh server secure-mac`

Default Disabled.

Mode Global Configuration

Usage notes To see the list of MAC algorithms, use the [show ssh server](#) command.

Example To force the SSH server to use best-practice MAC algorithms, use the commands:

```
awplus# configure terminal
awplus(config)# ssh server secure-mac
```

Related commands [show ssh server](#)
[ssh server](#)
[ssh server secure-algs](#)
[ssh server secure-ciphers](#)
[ssh server secure-kex](#)

Command changes Version 5.5.1-1.1: command added

ssh server sftp

Overview This command enables the Secure FTP (SFTP) service on the SSH server. Once enabled, the server accepts SFTP requests from remote clients.

You must enable the SSH server as well as this service before the device accepts SFTP connections. The SFTP service is enabled by default as soon as the SSH server is enabled. If the SSH server is disabled, SFTP service is unavailable.

The **no** variant of this command disables SFTP service on the SSH server. Once disabled, SFTP requests from remote clients are rejected.

Syntax ssh server sftp
no ssh server sftp

Mode Global Configuration

Examples To enable the SFTP service, use the commands:

```
awplus# configure terminal  
awplus(config)# ssh server sftp
```

To disable the SFTP service, use the commands:

```
awplus# configure terminal  
awplus(config)# no ssh server sftp
```

Related commands [show running-config ssh](#)
[show ssh server](#)

ssh server tcpforwarding

Overview Use this command to enable TCP port forwarding on the SSH server. It is disabled by default, to enhance security.

Use the **no** variant of this command to disable TCP port forwarding again.

Syntax `ssh server tcpforwarding`
`no ssh server tcpforwarding`

Default Disabled

Mode Global Configuration

Example To enable TCP port forwarding, use the commands:

```
awplus# configure terminal
awplus(config)# ssh server tcpforwarding
```

To disable it again, use the commands:

```
awplus# configure terminal
awplus(config)# no ssh server tcpforwarding
```

Related commands [show ssh server](#)

Command changes Version 5.5.2-1.1: command added

undebug ssh client

Overview This command applies the functionality of the **no debug ssh client** command.

undebug ssh server

Overview This command applies the functionality of the **no debug ssh server** command.

62

Trigger Commands

Introduction

Overview This chapter provides an alphabetical reference for commands used to configure Triggers. For more information, see the [Triggers Feature Overview and Configuration Guide](#).

For information on filtering and saving command output, see the [“Getting Started with AlliedWare Plus” Feature Overview and Configuration Guide](#).

- Command List**
- [“active \(trigger\)”](#) on page 3405
 - [“day”](#) on page 3406
 - [“debug trigger”](#) on page 3408
 - [“description \(trigger\)”](#) on page 3409
 - [“repeat”](#) on page 3410
 - [“script”](#) on page 3411
 - [“show debugging trigger”](#) on page 3413
 - [“show running-config trigger”](#) on page 3414
 - [“show trigger”](#) on page 3415
 - [“test”](#) on page 3420
 - [“time \(trigger\)”](#) on page 3421
 - [“trap”](#) on page 3423
 - [“trigger”](#) on page 3424
 - [“trigger activate”](#) on page 3425
 - [“type atmf guest”](#) on page 3426
 - [“type atmf node”](#) on page 3427
 - [“type cpu”](#) on page 3429
 - [“type env-sensor”](#) on page 3430

- [“type interface”](#) on page 3432
- [“type linkmon-probe”](#) on page 3433
- [“type log”](#) on page 3435
- [“type memory”](#) on page 3436
- [“type periodic”](#) on page 3437
- [“type ping-poll”](#) on page 3438
- [“type reboot”](#) on page 3439
- [“type time”](#) on page 3440
- [“type usb”](#) on page 3441
- [“undebug trigger”](#) on page 3442

active (trigger)

Overview This command enables a trigger. This allows the trigger to activate when its trigger conditions are met.

The **no** variant of this command disables a trigger. While in this state the trigger cannot activate when its trigger conditions are met.

Syntax active
no active

Default Active, which means that triggers are enabled by default

Mode Trigger Configuration

Usage notes Configure a trigger first before you use this command to activate it.

For information about configuring a trigger, see the [Triggers_Feature Overview and Configuration Guide](#).

Examples To enable trigger 172, so that it can activate when its trigger conditions are met, use the commands:

```
awplus# configure terminal
awplus(config)# trigger 172
awplus(config-trigger)# active
```

To disable trigger 182, preventing it from activating when its trigger conditions are met, use the commands:

```
awplus# configure terminal
awplus(config)# trigger 182
awplus(config-trigger)# no active
```

Related commands [show trigger](#)
[trigger](#)
[trigger activate](#)

day

Overview This command specifies the days or date that the trigger can activate on. You can specify one of:

- A specific date
- A specific day of the week
- A list of days of the week
- A day of any month of any year
- A day of a specific month in any year
- Every day

By default, the trigger can activate on any day.

Syntax `day every-day`
`day <1-31>`
`day <1-31> <month>`
`day <1-31> <month> <year>`
`day <weekday>`

Parameter	Description
<code>every-day</code>	Sets the trigger so that it can activate on any day.
<code><1-31></code>	Day of the month the trigger is permitted to activate on.
<code><month></code>	Sets the month that the trigger is permitted to activate on. Valid keywords are: january, february, march, april, may, june, july, august, september, october, november, and december.
<code><year></code>	Sets the year that the trigger is permitted to activate in, between 2000 and 2035.
<code><weekday></code>	Sets the days of the week that the trigger can activate on. You can specify one or more week days in a space separated list. Valid keywords are: monday, tuesday, wednesday, thursday, friday, saturday, and sunday.

Default **every-day**, so by default, the trigger can activate on any day.

Mode Trigger Configuration

Usage notes For example trigger configurations that use the **day** command, see “Restrict Internet Access” and “Turn off Power to Port LEDs” in the [Triggers Feature Overview and Configuration Guide](#).

Examples To permit trigger 55 to activate on the 1 June 2019, use the commands:

```
awplus# configure terminal
awplus(config)# trigger 55
awplus(config-trigger)# day 1 jun 2019
```

To permit trigger 12 to activate on Mondays, Wednesdays and Fridays, use the commands:

```
awplus# configure terminal
awplus(config)# trigger 12
awplus(config-trigger)# day monday wednesday friday
```

To permit trigger 17 to activate on the 5th day of any month, in any year, use the commands:

```
awplus# configure terminal
awplus(config)# trigger 17
awplus(config-trigger)# day 5
```

To permit trigger 6 to activate on the 20th day of September, in any year, use the commands:

```
awplus# configure terminal
awplus(config)# trigger 6
awplus(config-trigger)# day 20 september
```

To permit trigger 14 to activate on the 1st day of each month, in any year, at 11.00am, use the commands:

```
awplus# configure terminal
awplus(config)# trigger 14
awplus(config-trigger)# day 1
awplus(config-trigger)# type time 11:00
```

Related commands [show trigger](#)
[type time](#)
[trigger](#)

Command changes Version 5.4.8-2.1: day of the month functionality added

debug trigger

Overview This command enables trigger debugging. This generates detailed messages about how your device is processing the trigger commands and activating the triggers.

The **no** variant of this command disables trigger debugging.

Syntax `debug trigger`
`no debug trigger`

Mode Privilege Exec

Examples To start trigger debugging, use the command:

```
awplus# debug trigger
```

To stop trigger debugging, use the command:

```
awplus# no trigger
```

Related commands [show debugging trigger](#)
[show trigger](#)
[test](#)
[trigger](#)
[undebug trigger](#)

description (trigger)

Overview This command adds an optional description to help you identify the trigger. This description is displayed in show command outputs and log messages.

The **no** variant of this command removes a trigger's description. The show command outputs and log messages stop displaying a description for this trigger.

Syntax `description <description>`
`no description`

Parameter	Description
<code><description></code>	A word or phrase that uniquely identifies this trigger or its purpose. Valid characters are any printable character and spaces, up to a maximum of 40 characters.

Mode Trigger Configuration

Examples To give trigger 240 the description `daily status report`, use the commands:

```
awplus# configure terminal
awplus(config)# trigger 240
awplus(config-trigger)# description daily status report
```

To remove the description from trigger 36, use the commands:

```
awplus# configure terminal
awplus(config)# trigger 36
awplus(config-trigger)# no description
```

Related commands [show trigger](#)
[test](#)
[trigger](#)

repeat

Overview This command specifies the number of times that a trigger is permitted to activate. This allows you to specify whether you want the trigger to activate:

- only the first time that the trigger conditions are met
- a limited number of times that the trigger conditions are met
- an unlimited number of times

Once the trigger has reached the limit set with this command, the trigger remains in your configuration but cannot be activated. Use the **repeat** command again to reset the trigger so that it is activated when its trigger conditions are met.

By default, triggers can activate an unlimited number of times. To reset a trigger to this default, specify either **yes** or **forever**.

Syntax `repeat { forever | no | once | yes | <1-4294967294> }`

Parameter	Description
<code>yes forever</code>	The trigger repeats indefinitely, or until disabled.
<code>no once</code>	The trigger activates only once.
<code><1-4292967294></code>	The trigger repeats the specified number of times.

Mode Trigger Configuration

Examples To allow trigger 21 to activate only once, use the commands:

```
awplus# configure terminal
awplus(config)# trigger 21
awplus(config-trigger)# repeat no
```

To allow trigger 22 to activate an unlimited number of times whenever its trigger conditions are met, use the commands:

```
awplus# configure terminal
awplus(config)# trigger 22
awplus(config-trigger)# repeat forever
```

To allow trigger 23 to activate only the first 10 times the conditions are met, use the commands:

```
awplus# configure terminal
awplus(config)# trigger 23
awplus(config-trigger)# repeat 10
```

Related commands [show trigger](#)
[trigger](#)

script

Overview This command specifies one or more scripts that are to be run when the trigger activates. You can add up to five scripts to a single trigger.

The sequence in which the trigger runs the scripts is specified by the number you set before the name of the script file. One script is executed completely before the next script begins.

Scripts may be either ASH shell scripts, indicated by a **.sh** filename extension suffix, or AlliedWare Plus™ scripts, indicated by a **.scp** filename extension suffix. AlliedWare Plus™ scripts only need to be readable.

The **no** variant of this command removes one or more scripts from the trigger's script list. The scripts are identified by either their name, or by specifying their position in the script list. The **all** parameter removes all scripts from the trigger.

Syntax `script <1-5> {<filename>}`
`no script {<1-5>|<filename>|all}`

Parameter	Description
<1-5>	The position of the script in execution sequence. The trigger runs the lowest numbered script first.
<filename>	The path to the script file.

Mode Trigger Configuration

Examples To configure trigger 71 to run the script `flash:/cpu_trig.sh` in position 3 when the trigger activates, use the commands:

```
awplus# configure terminal
awplus(config)# trigger 71
awplus(config-trigger)# script 3 flash:/cpu_trig.sh
```

To configure trigger 99 to run the scripts **flash:reconfig.scp**, **flash:cpu_trig.sh** and **flash:email.scp** in positions 2, 3 and 5 when the trigger activates, use the following commands:

```
awplus# configure terminal
awplus(config)# trigger 99
awplus(config-trigger)# script 2 flash:/reconfig.scp 3
flash:/cpu_trig.sh 5 flash:/email.scp
```

To remove the scripts 1, 3 and 4 from trigger 71's script list, use the commands:

```
awplus# configure terminal
awplus(config)# trigger 71
awplus(config-trigger)# no script 1 3 4
```

To remove the script flash:/cpu_trig.sh from trigger 71's script list, use the commands:

```
awplus# configure terminal
awplus(config)# trigger 71
awplus(config-trigger)# no script flash:/cpu_trig.sh
```

To remove all the scripts from trigger 71's script list, use the commands:

```
awplus# configure terminal
awplus(config)# trigger 71
awplus(config-trigger)# no script all
```

Related commands [show trigger](#)
[trigger](#)

show debugging trigger

Overview This command displays the current status for trigger utility debugging. Use this command to show when trigger debugging has been turned on or off from the [debug trigger](#) command.

Syntax `show debugging trigger`

Mode User Exec and Privileged Exec

Example To display the current configuration of trigger debugging, use the command:

```
awplus# show debugging trigger
```

Output Figure 62-1: Example output from the **show debugging trigger** command

```
awplus#debug trigger
awplus#show debugging trigger
Trigger debugging status:
  Trigger debugging is on

awplus#no debug trigger
awplus#show debugging trigger
Trigger debugging status:
  Trigger debugging is off
```

Related commands [debug trigger](#)

show running-config trigger

Overview This command displays the current running configuration of the trigger utility.

Syntax `show running-config trigger`

Mode Privileged Exec

Example To display the current configuration of the trigger utility, use the command:

```
awplus# show running-config trigger
```

Figure 62-2: Example output from the **show running-config trigger** command

```
trigger 1
  type card in

type usb in
  trigger 2

type usb out
!
```

Related commands [show trigger](#)

show trigger

Overview This command displays configuration and diagnostic information about the triggers configured on the device. Specify the **show trigger** command without any options to display a summary of the configuration of all triggers.

Syntax `show trigger [<1-250>|counter|full]`

Parameter	Description
<1-250>	Displays detailed information about a specific trigger, identified by its trigger ID.
counter	Displays statistical information about all triggers.
full	Displays detailed information about all triggers.

Mode Privileged Exec

Example To get summary information about all triggers, use the following command:

```
awplus# show trigger
```

Table 62-1: Example output from **show trigger**

```
awplus#show trigger
TR# Type & Details      Name                Ac Te Repeat      #Scr Days/Date
-----
001 CPU (80% any)      Busy CPU            Y  N  5              1  smtwtfS
005 Periodic (30 min)  Regular status check Y  N  Continuous     1  -mtwtf-
007 Memory (85% up)   High mem usage      Y  N  8              1  smtwtfS
011 Time (00:01)      Weekend access      Y  N  Continuous     1  -----s
013 Reboot            Y  N  Continuous     2  smtwtfS
019 Ping-poll (5 up)  Connection to svr1  Y  N  Continuous     1  smtwtfS
-----
```

Table 62-2: Parameters in the output of **show trigger**

Parameter	Description
TR#	Trigger identifier (ID).
Type & Details	The trigger type, followed by the trigger details in brackets.
Name	Descriptive name of the trigger configured with the description (trigger) command.
Ac	Whether the trigger is active (Y), or inactive (N).
Te	Whether the trigger is in test mode (Y) or not (N).

Table 62-2: Parameters in the output of **show trigger** (cont.)

Parameter	Description
Repeat	Whether the trigger repeats continuously, and if not, the configured repeat count for the trigger. To see the number of times a trigger has activated, use the show trigger <1-250> command.
#Scr	Number of scripts associated with the trigger.
Days/Date	Days or date when the trigger may be activated. For the days options, the days are shown as a seven character string representing Sunday to Saturday. A hyphen indicates days when the trigger cannot be activated.

To display detailed information about trigger 3, use the command:

```
awplus# show trigger 3
```

Figure 62-3: Example output from **show trigger** for a specific trigger

```
awplus#show trigger 1
Trigger Configuration Details
-----
Trigger ..... 1
Name ..... display cpu usage when pass 80%
Type and details ..... CPU (80% up)
Days ..... smtwfss
Active ..... Yes
Test ..... No
Trap ..... Yes
Repeat ..... Continuous
Modified ..... Fri Feb 3 17:18:44 2017
Number of activations ..... 0
Last activation ..... not activated
Number of scripts ..... 1
1. shocpu.scp
2.
3.
4.
5.
-----
```

To display detailed information about all triggers, use the command:

```
awplus# show trigger full
```

Table 62-3: Example output from show trigger full

```
awplus#show trigger full
Trigger Configuration Details
-----
Trigger ..... 1
Name ..... Busy CPU
Type and details ..... CPU (80% up)
Days ..... smtwtfS
Active ..... Yes
Test ..... No
Trap ..... Yes
Repeat ..... Continuous
Modified ..... Fri Feb 3 17:05:16 2017
Number of activations ..... 0
Last activation ..... not activated
Number of scripts ..... 2
  1. flash:/cpu_alert.sh
  2. flash:/reconfig.scp
  3.
  4.
  5.
Trigger ..... 5
Name ..... Regular status check
Type and details ..... Periodic (30 min)
Days ..... smtwtfS
Active ..... Yes
Test ..... No
Trap ..... Yes
Repeat ..... 5 (2)
Modified ..... Fri Feb 3 17:18:44 2017
Number of activations ..... 0
Last activation ..... Fri Feb 10 18:00:00 2017
Number of scripts ..... 1
  1. flash:/stat_check.scp
  2.
  3.
  4.
  5.
-----
```

Table 63: Parameters in the output of **show trigger full** and **show trigger** for a specific trigger

Parameter	Description
Trigger	The ID of the trigger.
Name	Descriptive name of the trigger.
Type and details	The trigger type and its activation conditions.
Days	The days on which the trigger is permitted to activate.

Table 63: Parameters in the output of **show trigger full** and **show trigger** for a specific trigger (cont.)

Parameter	Description
Date	The date on which the trigger is permitted to activate. Only displayed if configured, in which case it replaces "Days".
Active	Whether or not the trigger is permitted to activate.
Test	Whether or not the trigger is operating in diagnostic mode.
Trap	Whether or not the trigger is enabled to send SNMP traps.
Repeat	Whether the trigger repeats an unlimited number of times (Continuous) or for a set number of times. When the trigger can repeat only a set number of times, then the number of times the trigger has been activated is displayed in brackets.
Modified	The date and time of the last time that the trigger was modified.
Number of activations	Number of times the trigger has been activated since the last restart of the device.
Last activation	The date and time of the last time that the trigger was activated.
Number of scripts	How many scripts are associated with the trigger, followed by the names of the script files in the order in which they run.

To display counter information about all triggers use the command:

```
awplus# show trigger counter
```

Figure 62-4: Example output from **show trigger counter**

```
awplus# show trigger counter
Trigger Module Counters
-----
Trigger activations                4
Last trigger activated             55
Time triggers activated today      0
Periodic triggers activated today  0
Interface triggers activated today  1
CPU triggers activated today       2
Memory triggers activated today    1
Reboot triggers activated today    0
Ping-poll triggers activated today  0
USB event triggers activated today  0
Stack master fail triggers activated today  0
Stack member triggers activated today  0
Stack link triggers activated today  0
ATMF node triggers activated today  0
ATMF guest triggers activated today  0
Log triggers activated today       0
-----
```

**Related
commands** active (trigger)
 debug trigger
 script
 trigger
 trigger activate

test

Overview This command puts the trigger into a diagnostic mode. In this mode the trigger may activate but when it does it will not run any of the trigger's scripts. A log message will be generated to indicate when the trigger has been activated.

The **no** variant of this command takes the trigger out of diagnostic mode, restoring normal operation. When the trigger activates, the scripts associated with the trigger will be run, as normal.

Syntax test
no test

Mode Trigger Configuration

Usage notes Configure a trigger first before you use this command to diagnose it. For information about configuring a trigger, see the [Triggers_Feature Overview and Configuration Guide](#).

Examples To put trigger 5 into diagnostic mode, where no scripts will be run when the trigger activates, use the commands:

```
awplus# configure terminal
awplus(config)# trigger 5
awplus(config-trigger)# test
```

To take trigger 205 out of diagnostic mode, restoring normal operation, use the commands:

```
awplus# configure terminal
awplus(config)# trigger 205
awplus(config-trigger)# no test
```

Related commands [show trigger](#)
[trigger](#)

time (trigger)

Overview This command specifies the time of day when the trigger is permitted to activate. The **after** parameter specifies the start of a time period that extends to midnight during which trigger may activate. By default the value of this parameter is 00:00:00 (am); that is, the trigger may activate at any time. The **before** parameter specifies the end of a time period beginning at midnight during which the trigger may activate. By default the value of this parameter is 23:59:59; that is, the trigger may activate at any time. If the value specified for **before** is later than the value specified for **after**, a time period from “after” to “before” is defined, during which the trigger may activate. This command is not applicable to time triggers (**type time**).

The following figure illustrates how the **before** and **after** parameters operate.

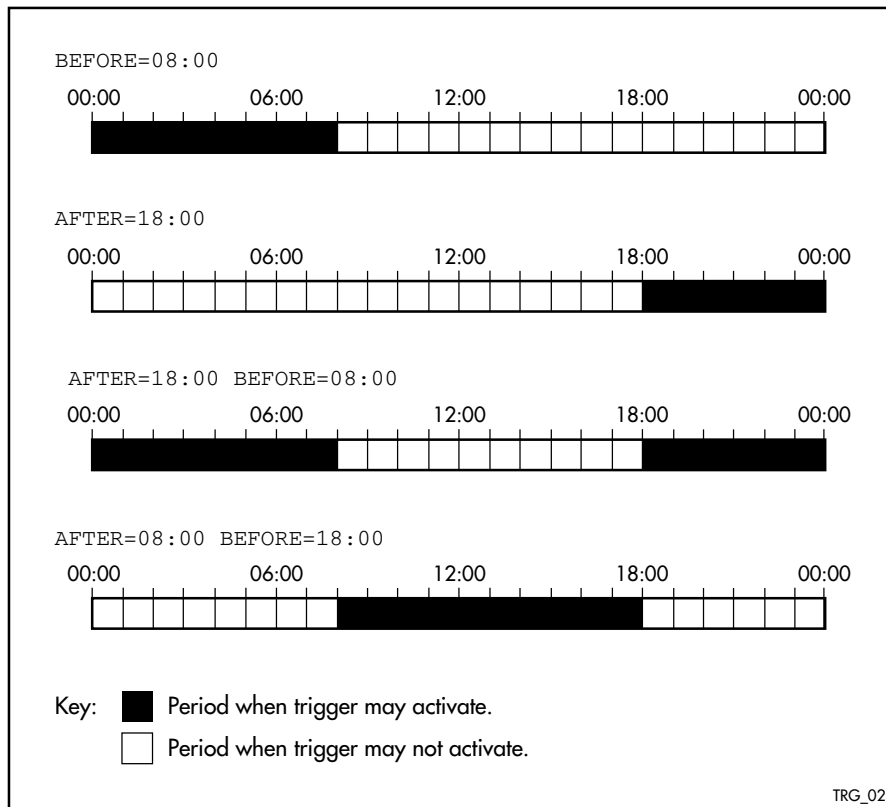

Syntax `time {[after <hh:mm:ss>] [before <hh:mm:ss>]}`

Parameter	Description
<code>after<hh:mm:ss></code>	The earliest time of day when the trigger may be activated.
<code>before<hh:mm:ss></code>	The latest time of day when the trigger may be activated.

Mode Trigger Configuration

Usage notes For example trigger configurations that use the **time (trigger)** command, see “Restrict Internet Access” and “Turn off Power to Port LEDs” in the [Triggers Feature Overview and Configuration Guide](#).

Examples To allow trigger 63 to activate between midnight and 10:30am, use the commands:

```
awplus# configure terminal
awplus(config)# trigger 63
awplus(config-trigger)# time before 10:30:00
```

To allow trigger 64 to activate between 3:45pm and midnight, use the commands:

```
awplus# configure terminal
awplus(config)# trigger 64
awplus(config-trigger)# time after 15:45:00
```

To allow trigger 65 to activate between 10:30am and 8:15pm, use the commands:

```
awplus# configure terminal
awplus(config)# trigger 65
awplus(config-trigger)# time after 10:30:00 before 20:15:00
```

Related commands [show trigger](#)
[trigger](#)

trap

Overview This command enables the specified trigger to send SNMP traps.

Use the **no** variant of this command to disable the sending of SNMP traps from the specified trigger.

Syntax trap
no trap

Default SNMP traps are enabled by default for all defined triggers.

Mode Trigger Configuration

Usage notes You must configure SNMP before using traps with triggers. For more information, see:

- [Support for Allied Telesis Enterprise_MIBs_in_AlliedWare Plus](#), for information about which MIB objects are supported.
- the [SNMP Feature Overview and Configuration_Guide](#).
- the [SNMP Commands](#) chapter.

Since SNMP traps are enabled by default for all defined triggers, a common usage will be for the **no** variant of this command to disable SNMP traps from a specified trap if the trap is only periodic. Refer in particular to AT-TRIGGER-MIB in the [Support for Allied Telesis Enterprise_MIBs_in AlliedWare Plus](#) for further information about the relevant SNMP MIB.

Examples To enable SNMP traps to be sent from trigger 5, use the commands:

```
awplus# configure terminal
awplus(config)# trigger 5
awplus(config-trigger)# trap
```

To disable SNMP traps being sent from trigger 205, use the commands:

```
awplus# configure terminal
awplus(config)# trigger 205
awplus(config-trigger)# no trap
```

Related commands [trigger](#)
[show trigger](#)

trigger

Overview This command is used to access the Trigger Configuration mode for the specified trigger. Once Trigger Configuration mode has been entered the trigger type information can be configured and the trigger scripts and other operational parameters can be specified. At a minimum the trigger type information must be specified before the trigger can become active.

The **no** variant of this command removes a specified trigger and all configuration associated with it.

Syntax trigger <1-250>
no trigger <1-250>

Parameter	Description
<1-250>	A trigger ID.

Mode Global Configuration

Examples To enter trigger configuration mode for trigger 12, use the commands:

```
awplus# configure terminal  
awplus(config)# trigger 12
```

To completely remove all configuration associated with trigger 12, use the commands:

```
awplus# configure terminal  
awplus(config)# no trigger 12
```

Related commands [show trigger](#)
[trigger activate](#)

trigger activate

Overview This command is used to manually activate a specified trigger from the Privileged Exec mode, which has been configured with the **trigger** command from the Global Configuration mode.

Syntax `trigger activate <1-250>`

Parameter	Description
<1-250>	A trigger ID.

Mode Privileged Exec

Usage notes This command manually activates a trigger without the normal trigger conditions being met.

The trigger is activated even if it has been configured as inactive by using the command **no active**. The scripts associated with the trigger will be executed even if the trigger is in the diagnostic test mode.

Triggers activated manually do not have their repeat counts decremented or their 'last triggered' time updated, and do not result in updates to the '[type] triggers today' counters.

Example To manually activate trigger 12 use the command:

```
awplus# trigger activate 12
```

Related commands

- [active \(trigger\)](#)
- [show trigger](#)
- [trigger](#)

type atmf guest

Overview This command configures a trigger to activate when an AMF guest node joins or leaves.

Syntax `type atmf guest {join|leave}`

Parameter	Description
join	AMF guest node joins.
leave	AMF guest node leaves.

Mode Trigger Configuration

Example To configure trigger 86 to activate when an AMF guest node leaves, use the following commands:

```
awplus(config)# trigger 86  
awplus(config-trigger)# type atmf guest leave
```

Related commands [show trigger](#)

Command changes Version 5.5.1-1.1: command added

type atmf node

Overview This command configures a trigger to activate when an AMF node joins or leaves.

Syntax type atmf node {join|leave}

Parameter	Description
join	AMF node joins.
leave	AMF node leaves.

Mode Trigger Configuration

Example 1 To configure trigger 5 to activate when an AMF node leaves, use the following commands. In this example the command is entered on node-1:

```
node1(config)# trigger 5
node1(config-trigger)# type atmf node leave
```

Example 2 The following commands will configure trigger 5 to activate if an AMF node join event occurs on any node within the working set:

```
node1# atmf working-set group all
```

This command returns the following display:

```
=====
node1, node2, node3:
=====

Working set join
```

Note that the running the above command changes the prompt from the name of the local node, to the name of the AMF-Network followed, in square brackets, by the number of member nodes in the working set.

```
AMF-Net[3]# conf t
AMF-Net[3](config)# trigger 5
AMF-Net[3](config-trigger)# type atmf node leave
AMF-Net[3](config-trigger)# description "E-mail on AMF Exit"
AMF-Net[3](config-trigger)# active
```

Enter the name of the script to run at the trigger event.

```
AMF-Net[3](config-trigger)# script 1 email_me.scp
AMF-Net[3](config-trigger)# end
```

Display the trigger configurations

```
AMF-Net[3]# show trigger
```

This command returns the following display:

```
=====
node1:
=====

TR# Type & Details      Description          Ac Te Tr Repeat      #Scr Days/Date
-----
001 Periodic (2 min)    Periodic Status Chk  Y  N  Y Continuous    1  smtwtfS
005 ATMF node (leave)  E-mail on ATMF Exit  Y  N  Y Continuous    1  smtwtfS
-----

=====
Node2, Node3,
=====

TR# Type & Details      Description          Ac Te Tr Repeat      #Scr Days/Date
-----
005 ATMF node (leave)  E-mail on ATMF Exit  Y  N  Y Continuous    1  smtwtfS
-----
```

Display the triggers configured on each of the nodes in the AMF Network.

```
AMF-Net[3]# show running-config trigger
```

This command returns the following display:

```
=====
Node1:
=====

trigger 1
  type periodic 2
  script 1 atmf.scp
trigger 5
  type atmf node leave
description "E-mail on ATMF Exit"
  script 1 email_me.scp
!

=====
Node2, Node3:
=====

trigger 5
  type atmf node leave
description "E-mail on ATMF Exit"
  script 1 email_me.scp
!
```

Related commands [show trigger](#)

type cpu

Overview This command configures a trigger to activate based on CPU usage level. Selecting the **up** option causes the trigger to activate when the CPU usage exceeds the specified usage level. Selecting the **down** option causes the trigger to activate when CPU usage drops below the specified usage level. Selecting **any** causes the trigger to activate in both situations. The default is **any**.

Syntax `type cpu <1-100> [up|down|any]`

Parameter	Description
<1-100>	The percentage of CPU usage at which to trigger.
up	Activate when CPU usage exceeds the specified level.
down	Activate when CPU usage drops below the specified level
any	Activate when CPU usage passes the specified level in either direction

Mode Trigger Configuration

Usage notes For an example trigger configuration that uses the **type cpu** command, see “Capture Unusual CPU and RAM Activity” in the [Triggers Feature Overview and Configuration Guide](#).

Examples To configure trigger 28 to be a CPU trigger that activates when CPU usage exceeds 80% use the following commands:

```
awplus# configure terminal
awplus(config)# trigger 28
awplus(config-trigger)# type cpu 80 up
```

To configure trigger 5 to be a CPU trigger that activates when CPU usage either rises above or drops below 65%, use the following commands:

```
awplus# configure terminal
awplus(config)# trigger 5
awplus(config-trigger)# type cpu 65

or

awplus# configure terminal
awplus(config)# trigger 5
awplus(config-trigger)# type cpu 65 any
```

Related commands [show trigger](#)
[trigger](#)

type env-sensor

Overview Use this command to create a trigger that will run a script when the device's environment sensors detect an event. Environment sensors are shown in the output of the command [show system environment](#), and include things like device temperature, power settings and voltage.

Depending on the device and sensor, you can create a trigger to run when:

- the sensor's state changes, for example when a loss of power is detected for a power supply, or when power is restored, or both.
- the sensor's reading crosses a high or low threshold, for example when the device temperature becomes too high, or returns to normal, or both.

Syntax when a sensor changes state

```
type env-sensor resource <resource-id> sensor <sensor-id> state {true|false|any}
```

Parameter	Description
resource <resource-id>	The 'Resource ID' for the device, as shown in output of the command show system environment .
sensor <sensor-id>	The 'ID' for the sensor, as shown in output of the command show system environment .
state true	The trigger will activate if this sensor reading changes to 'Yes' or 'Open' in the output of show system environment .
state false	The trigger will activate if this sensor reading changes to 'No' or 'Closed' in the output of show system environment .
state any	The trigger will activate if this sensor reading changes to any of 'Yes', 'Open', 'No', or 'Closed'.

Syntax when a sensor crosses a threshold

```
type env-sensor resource <resource-id> sensor <sensor-id> {low-limit|high-limit} {exceeded|cleared|any}
```

Parameter	Description
resource <resource-id>	The 'Resource ID' for the device, as shown in output of the command show system environment .
sensor <sensor-id>	The 'ID' for the sensor, as shown in output of the command show system environment .
low-limit	The trigger will activate when the sensor reading falls below the 'Low Limit' alarm threshold shown in show system environment , or returns to an acceptable value after being too low, or both. The alarm threshold values are pre-defined within the device and cannot be changed.

Parameter	Description
high-limit	The trigger will activate when the sensor reading rises above the 'High Limit' alarm threshold shown in show system environment , or returns to an acceptable value after being too high, or both. The alarm threshold values are pre-defined within the device and cannot be changed.
exceeded	If you chose low-limit, the trigger will trigger if the sensor's reading falls below the low limit. If you chose high-limit, the trigger will trigger if the sensor's reading goes above the high limit.
cleared	If you chose low-limit, the trigger will trigger if the sensor's reading rises to above the low limit again. If you chose high-limit, the trigger will trigger if the sensor's reading falls below the high limit again. Some temperature sensors include a hysteresis value and will not clear until the temperature has changed significantly. For example, if a sensor has a high alarm threshold of 75 degrees Celsius, the hysteresis value may mean that the alarm clears when the temperature falls to 63 degrees Celsius.
any	The trigger will trigger if the low or high limit is either exceeded or cleared.

Mode Global Configuration

Example To configure trigger 1, which will activate when the internal temperature becomes too high or drops to a low-enough value after being too high, use the following commands. In this example, the monitored temperature has a resource ID of 4 and a sensor ID of 6:

```
awplus# configure terminal
awplus(config)# trigger 1
awplus(config)# type env-sensor resource 4 sensor 6 high-limit
any
```

Related commands [show system environment](#)
[show trigger](#)
[trigger](#)

Command changes Version 5.5.2-1.1: command added

type interface

Overview This command configures a trigger to activate based on the link status of an interface. The trigger can be activated when the interface becomes operational by using the **up** option, or when the interface closes by using the **down** option. The trigger can also be configured to activate when either one of these events occurs by using the **any** option.

Syntax `type interface <interface> {up|down|any}`

Parameter	Description
<interface>	Interface name.
up	Activate when interface becomes operational.
down	Activate when the interface closes.
any	Activate when any interface link status event occurs.

Mode Trigger Configuration

Example To configure trigger 19 to be an interface trigger that activates when port1.0.1 becomes operational, use the following commands:

```
awplus# configure terminal
awplus(config)# trigger 19
awplus(config-trigger)# type interface port1.0.1 up
```

Related commands [show trigger](#)
[trigger](#)

type linkmon-probe

Overview Use this command to create a trigger that will run a script when a Link Health Monitoring probe reports that a link becomes “good”, “bad”, or “unreachable”.

Syntax `type linkmon-probe <probename> <profilename>
{good|bad|unreachable|any}`

Parameter	Description
<probename>	The name of the Link Health Monitoring probe that will be used for executing the trigger.
<profilename>	The name of the Link Health Monitoring performance profile that will be used for determine if the Link Health Monitoring probe is good, bad, or unreachable.
good	If the Link Health Monitoring probe becomes 'good' according to the Link Health Monitoring performance profile then the trigger will be executed.
bad	If the Link Health Monitoring probe goes 'bad' according to the Link Health Monitoring performance profile then the trigger will be executed.
unreachable	If the Link Health Monitoring probe becomes 'unreachable' according to the Link Health Monitoring performance profile then the trigger will be executed.
any	If the Link Health Monitoring probe changes state according to the Link Health Monitoring performance profile then the trigger will be executed.

Mode Trigger Configuration

Example When the Link Health Monitoring probes sent to the “test-probe” destination no longer meet the performance profile “test-profile” the link will be deemed “bad”. To create a trigger that will run a script when a Link Health Monitoring probe is deemed “bad”, use the following commands:

```
awplus# trigger 1  
awplus(config)# script 1 link-bad.scp  
awplus(config)# type linkmon-probe test-probe test-profile bad
```

To create a trigger that will run a script when the link is deemed “good” again, use the following commands:

```
awplus# trigger 2  
awplus(config)# script 1 link-good.scp  
awplus(config)# type linkmon-probe test-probe test-profile good
```

Related commands [trigger](#)

Command changes Version 5.4.8-1.1: command added

type log

Overview Use this command to configure a trigger to activate based on the content of log messages matching a string or regular expression.

Syntax `type log <log-message-string>`

Parameter	Description
<code><log-message-string></code>	A string or a regular expression (PCRE) to match a log message or part of a log message.

Default There is no type or log message string set by default.

Mode Trigger Configuration

Usage notes Log type triggers fully support regular expressions using PCRE (Perl-Compatible Regular Expression) syntax.

Only log messages of severity level notice or higher can activate a trigger.

Note that any command executed by the script will generate a log message with level notice, and will include '[SCRIPT]' before the command string. Therefore, if something in the script matches the configured log message trigger string, it will retrigger indefinitely.

Example To configure trigger 6 to activate when a log message of level notice or higher indicates that any port has 'failed', use the commands:

```
awplus# configure terminal
awplus(config)# trigger 6
awplus(config-trigger)# type log port.+ failed
```

Related commands [show trigger](#)
[trigger](#)

Command changes Version 5.4.7-2.1: command added

type memory

Overview This command configures a trigger to activate based on RAM usage level. Selecting the **up** option causes the trigger to activate when memory usage exceeds the specified level. Selecting the **down** option causes the trigger to activate when memory usage drops below the specified level. Selecting **any** causes the trigger to activate in both situations. The default is **any**.

Syntax `type memory <1-100> [up|down|any]`

Parameter	Description
<1-100>	The percentage of memory usage at which to trigger.
up	Activate when memory usage exceeds the specified level.
down	Activate when memory usage drops below the specified level.
any	Activate when memory usage passes the specified level in either direction.

Mode Trigger Configuration

Examples To configure trigger 12 to be a memory trigger that activates when memory usage exceeds 50% use the following commands:

```
awplus# configure terminal
awplus(config)# trigger 12
awplus(config-trigger)# type memory 50 up
```

To configure trigger 40 to be a memory trigger that activates when memory usage either rises above or drops below 65%, use the following commands:

```
awplus# configure terminal
awplus(config)# trigger 40
awplus(config-trigger)# type memory 65
```

or

```
awplus# configure terminal
awplus(config)# trigger 40
awplus(config-trigger)# type memory 65 any
```

Related commands [show trigger](#)
[trigger](#)

type periodic

Overview This command configures a trigger to be activated at regular intervals. The time period between activations is specified in minutes.

Syntax `type periodic <1-1440>`

Parameter	Description
<code><1-1440></code>	The number of minutes between activations.

Mode Trigger Configuration

Usage notes A combined limit of 10 triggers of the type periodic and time can be configured. If you attempt to add more than 10 triggers the following error message is displayed:

```
% Cannot configure more than 10 triggers with the type time or periodic
```

For an example trigger configuration that uses the **type periodic** command, see "See Daily Statistics" in the [Triggers_Feature Overview and Configuration Guide](#).

Example To configure trigger 44 to activate periodically at 10 minute intervals use the following commands:

```
awplus# configure terminal
awplus(config)# trigger 44
awplus(config-trigger)# type periodic 10
```

Related commands [show trigger](#)
[trigger](#)

type ping-poll

Overview This command configures a trigger that activates when Ping Polling identifies that a target device's status has changed. This allows you to run a configuration script when a device becomes reachable or unreachable.

Syntax `type ping-poll <1-100> {up|down}`

Parameter	Description
<1-100>	The ping poll ID.
up	The trigger activates when ping polling detects that the target is reachable.
down	The trigger activates when ping polling detects that the target is unreachable.

Mode Trigger Configuration

Example To configure trigger 106 to activate when ping poll 12 detects that its target device is now unreachable, use the following commands:

```
awplus# configure terminal
awplus(config)# trigger 106
awplus(config-trigger)# type ping-poll 12 down
```

Related commands [show trigger](#)
[trigger](#)

type reboot

Overview This command configures a trigger that activates when your device is rebooted.

Syntax type reboot

Mode Trigger Configuration

Example To configure trigger 32 to activate when your device reboots, use the following commands:

```
awplus# configure terminal
awplus(config)# trigger 32
awplus(config-trigger)# type reboot
```

Related commands [show trigger](#)
[trigger](#)

type time

Overview This command configures a trigger that activates at a specified time of day.

Syntax `type time <hh:mm>`

Parameter	Description
<code><hh:mm></code>	The time to activate the trigger.

Mode Trigger Configuration

Usage A combined limit of 10 triggers of the type time and type periodic can be configured. If you attempt to add more than 10 triggers the following error message is displayed:

```
% Cannot configure more than 10 triggers with the type time or
periodic
```

Example To configure trigger 86 to activate at 15:53, use the following commands:

```
awplus# configure terminal
awplus(config)# trigger 86
awplus(config-trigger)# type time 15:53
```

Related commands [show trigger](#)
[trigger](#)

type usb

Overview Use this command to configure a trigger that activates on either the removal or the insertion of a USB storage device.

Syntax `type usb {in|out}`

Parameter	Description
in	Trigger activates on insertion of a USB storage device.
out	Trigger activates on removal of a USB storage device.

Mode Trigger Configuration

Usage notes USB triggers cannot execute script files from a USB storage device.

Examples To configure trigger 1 to activate on the insertion of a USB storage device, use the commands:

```
awplus# configure terminal
awplus(config)# trigger 1
awplus(config-trigger)# type usb in
```

Related commands [trigger](#)
[show running-config trigger](#)
[show trigger](#)

undebbug trigger

Overview This command applies the functionality of the **no debug trigger** command.

63

Ping-Polling Commands

Introduction

Overview This chapter provides an alphabetical reference for commands used to configure Ping Polling. For more information, see the [Ping Polling Feature Overview and Configuration Guide](#).

For information on filtering and saving command output, see the [“Getting Started with AlliedWare Plus” Feature Overview and Configuration Guide](#).

Table 63-1: The following table lists the default values when configuring a ping poll

Default	Value
Critical-interval	1 second
Description	No description
Fail-count	5
Length	32 bytes
Normal-interval	30 seconds
Sample-size	5
Source-ip	The IP address of the interface from which the ping packets are transmitted
Time-out	1 second
Up-count	30

- Command List**
- [“active \(ping-polling\)”](#) on page 3445
 - [“clear ping-poll”](#) on page 3446
 - [“critical-interval”](#) on page 3447
 - [“debug ping-poll”](#) on page 3448

- [“description \(ping-polling\)”](#) on page 3449
- [“fail-count”](#) on page 3450
- [“ip \(ping-polling\)”](#) on page 3451
- [“length \(ping-poll data\)”](#) on page 3452
- [“normal-interval”](#) on page 3453
- [“ping-poll”](#) on page 3454
- [“sample-size”](#) on page 3455
- [“show counter ping-poll”](#) on page 3457
- [“show ping-poll”](#) on page 3459
- [“source-ip”](#) on page 3463
- [“timeout \(ping polling\)”](#) on page 3465
- [“up-count”](#) on page 3466
- [“undebug ping-poll”](#) on page 3467

active (ping-polling)

Overview This command enables a ping-poll instance. The polling instance sends ICMP echo requests to the device with the IP address specified by the [ip \(ping-polling\)](#) command.

By default, polling instances are disabled. When a polling instance is enabled, it assumes that the device it is polling is unreachable.

The **no** variant of this command disables a ping-poll instance. The polling instance no longer sends ICMP echo requests to the polled device. This also resets all counters for this polling instance.

Syntax active
no active

Mode Ping-Polling Configuration

Examples To activate the ping-poll instance 43, use the commands:

```
awplus# configure terminal
awplus(config)# ping-poll 43
awplus(config-ping-poll)# active
```

To disable the ping-poll instance 43 and reset its counters, use the commands:

```
awplus# configure terminal
awplus(config)# ping-poll 43
awplus(config-ping-poll)# no active
```

Related commands [debug ping-poll](#)
[ip \(ping-polling\)](#)
[ping-poll](#)
[show ping-poll](#)

clear ping-poll

Overview This command resets the specified ping poll, or all ping poll instances. This clears the ping counters, and changes the status of polled devices to unreachable. The polling instance changes to the polling frequency specified with the [critical-interval](#) command. The device status changes to reachable once the device responses have reached the [up-count](#).

Syntax `clear ping-poll {<1-100>|all}`

Parameter	Description
<1-100>	A ping poll ID number. The specified ping poll instance has its counters cleared, and the status of the device it polls is changed to unreachable.
all	Clears the counters and changes the device status of all polling instances.

Mode Privileged Exec

Examples To reset the ping poll instance 12, use the command:

```
awplus# clear ping-poll 12
```

To reset all ping poll instances, use the command:

```
awplus# clear ping-poll all
```

Related commands

- [active \(ping-polling\)](#)
- [ping-poll](#)
- [show ping-poll](#)

critical-interval

Overview This command specifies the time period in seconds between pings when the polling instance has not received a reply to at least one ping, and when the device is unreachable.

This command enables the device to quickly observe changes in state, and should be set to a much lower value than the [normal-interval](#) command.

The **no** variant of this command sets the critical interval to the default of one second.

Syntax `critical-interval <1-65536>`
`no critical-interval`

Parameter	Description
<code><1-65536></code>	Time in seconds between pings, when the device has failed to a ping, or the device is unreachable.

Default The default is 1 second.

Mode Ping-Polling Configuration

Examples To set the critical interval to 2 seconds for the ping-polling instance 99, use the commands:

```
awplus# configure terminal
awplus(config)# ping-poll 99
awplus(config-ping-poll)# critical-interval 2
```

To reset the critical interval to the default of one second for the ping-polling instance 99, use the commands:

```
awplus# configure terminal
awplus(config)# ping-poll 99
awplus(config-ping-poll)# no critical-interval
```

Related commands

[fail-count](#)
[normal-interval](#)
[sample-size](#)
[show ping-poll](#)
[timeout \(ping polling\)](#)
[up-count](#)

debug ping-poll

Overview This command enables ping poll debugging for the specified ping-poll instance. This generates detailed messages about ping execution.

The **no** variant of this command disables ping-poll debugging for the specified ping-poll.

Syntax `debug ping-poll <1-100>`
`no debug ping-poll {<1-100>|all}`

Parameter	Description
<1-100>	A unique ping poll ID number.
all	Turn off all ping-poll debugging.

Mode Privileged Exec

Examples To enable debugging for ping-poll instance 88, use the command:

```
awplus# debug ping-poll 88
```

To disable all ping poll debugging, use the command:

```
awplus# no debug ping-poll all
```

To disable debugging for ping-poll instance 88, use the command:

```
awplus# no debug ping-poll 88
```

Related commands

- [active \(ping-polling\)](#)
- [clear ping-poll](#)
- [ping-poll](#)
- [show ping-poll](#)
- [undebug ping-poll](#)

description (ping-polling)

Overview This command specifies a string to describe the ping-polling instance. This allows the ping-polling instance to be recognized easily in show commands. Setting this command is optional.

By default ping-poll instances do not have a description.

Use the **no** variant of this command to delete the description set.

Syntax `description <description>`
`no description`

Parameter	Description
<code><description></code>	The description of the target. Valid characters are any printable character and spaces. There is no maximum character length.

Mode Ping-Polling Configuration

Examples To add the text "Primary Gateway" to describe the ping-poll instance 45, use the commands:

```
awplus# configure terminal
awplus(config)# ping-poll 45
awplus(config-ping-poll)# description Primary Gateway
```

To delete the description set for the ping-poll instance 45, use the commands:

```
awplus# configure terminal
awplus(config)# ping-poll 45
awplus(config-ping-poll)# no description
```

Related commands [ping-poll](#)
[show ping-poll](#)

fail-count

Overview This command specifies the number of pings that must be unanswered, within the total number of pings specified by the [sample-size](#) command, for the ping-polling instance to consider the device unreachable.

If the number set by the [sample-size](#) command and the **fail-count** commands are the same, then the unanswered pings must be consecutive. If the number set by the [sample-size](#) command is greater than the number set by the **fail-count** command, then a device that does not always reply to pings may be declared unreachable.

The **no** variant of this command resets the fail count to the default.

Syntax `fail-count <1-100>`
`no fail-count`

Parameter	Description
<code><1-100></code>	The number of pings within the sample size that a reachable device must fail to respond to before it is classified as unreachable.

Default The default is 5.

Mode Ping-Polling Configuration

Examples To specify the number of pings that must fail within the sample size to determine that a device is unreachable for ping-polling instance 45, use the commands:

```
awplus# configure terminal
awplus(config)# ping-poll 45
awplus(config-ping-poll)# fail-count 5
```

To reset the fail-count to its default of 5 for ping-polling instance 45, use the commands:

```
awplus# configure terminal
awplus(config)# ping-poll 45
awplus(config-ping-poll)# no fail-count
```

Related commands

- [critical-interval](#)
- [normal-interval](#)
- [ping-poll](#)
- [sample-size](#)
- [show ping-poll](#)
- [timeout \(ping polling\)](#)
- [up-count](#)

ip (ping-polling)

Overview This command specifies the IPv4 address of the device you are polling.

Syntax `ip {<ip-address>|<ipv6-address>}`

Parameter	Description
<code><ip-address></code>	An IPv4 address in dotted decimal notation A.B.C.D
<code><ipv6-address></code>	An IPv6 address in hexadecimal notation X:X::X:X

Mode Ping-Polling Configuration

Examples To set ping-poll instance 5 to poll the device with the IP address 192.168.0.1, use the commands:

```
awplus# configure terminal
awplus(config)# ping-poll 5
awplus(config-ping-poll)# ip 192.168.0.1
```

To set ping-poll instance 10 to poll the device with the IPv6 address 2001:db8::, use the commands:

```
awplus# configure terminal
awplus(config)# ping-poll 10
awplus(config-ping-poll)# ip 2001:db8::
```

Related commands

- [ping-poll](#)
- [source-ip](#)
- [show ping-poll](#)

length (ping-poll data)

Overview This command specifies the number of data bytes to include in the data portion of the ping packet. This allows you to set the ping packets to a larger size if you find that larger packet types in your network are not reaching the polled device, while smaller packets are getting through. This encourages the polling instance to change the device's status to unreachable when the network is dropping packets of the size you are interested in.

The **no** variant of this command resets the data bytes to the default of 32 bytes.

Syntax length <4-1500>
no length

Parameter	Description
<4-1500>	The number of data bytes to include in the data portion of the ping packet.

Default The default is 32.

Mode Ping-Polling Configuration

Examples To specify that ping-poll instance 12 sends ping packet with a data portion of 56 bytes, use the commands:

```
awplus# configure terminal
awplus(config)# ping-poll 12
awplus(config-ping-poll)# length 56
```

To reset the number of data bytes in the ping packet to the default of 32 bytes for ping-poll instance 3, use the commands:

```
awplus# configure terminal
awplus(config)# ping-poll 12
awplus(config-ping-poll)# length
```

Related commands ping-poll
show ping-poll

normal-interval

Overview This command specifies the time period between pings when the device is reachable.

The **no** variant of this command resets the time period to the default of 30 seconds.

Syntax `normal-interval <1-65536>`
`no normal-interval`

Parameter	Description
<code><1-65536></code>	Time in seconds between pings when the target is reachable.

Default The default is 30 seconds.

Mode Ping-Polling Configuration

Examples To specify a time period of 60 seconds between pings when the device is reachable for ping-poll instance 45, use the commands:

```
awplus# configure terminal
awplus(config)# ping-poll 45
awplus(config-ping-poll)# normal-interval 60
```

To reset the interval to the default of 30 seconds for ping-poll instance 45, use the commands:

```
awplus# configure terminal
awplus(config)# ping-poll 45
awplus(config-ping-poll)# no normal-interval
```

Related commands

- [critical-interval](#)
- [fail-count](#)
- [ping-poll](#)
- [sample-size](#)
- [show ping-poll](#)
- [timeout \(ping polling\)](#)
- [up-count](#)

ping-poll

Overview This command enters the ping-poll configuration mode. If a ping-poll exists with the specified number, then this command enters its configuration mode. If no ping-poll exists with the specified number, then this command creates a new ping poll with this ID number.

To configure a ping-poll, create a ping poll using this command, and use the [ip \(ping-polling\)](#) command to specify the device you want the polling instance to poll. It is not necessary to specify any further commands unless you want to change a command's default.

The **no** variant of this command deletes the specified ping poll.

Syntax `ping-poll <1-100>`
`no ping-poll <1-100>`

Parameter	Description
<1-100>	A unique ping poll ID number.

Mode Global Configuration

Examples To create ping-poll instance 3 and enter ping-poll configuration mode, use the commands:

```
awplus# configure terminal
awplus(config)# ping-poll 3
awplus(config-ping-poll)#
```

To delete ping-poll instance 3, use the commands:

```
awplus# configure terminal
awplus(config)# no ping-poll 3
```

Related commands

- [active \(ping-polling\)](#)
- [clear ping-poll](#)
- [debug ping-poll](#)
- [description \(ping-polling\)](#)
- [ip \(ping-polling\)](#)
- [length \(ping-poll data\)](#)
- [show ping-poll](#)
- [source-ip](#)

sample-size

Overview This command sets the total number of pings that the polling instance inspects when determining whether a device is unreachable. If the number of pings specified by the **fail-count** command go unanswered within the inspected sample, then the device is declared unreachable.

If the numbers set in this command and **fail-count** command are the same, the unanswered pings must be consecutive. If the number set by this command is greater than that set with the **fail-count** command, a device that does not always reply to pings may be declared unreachable.

You cannot set this command's value lower than the **fail-count** value.

The polling instance uses the number of pings specified by the **up-count** command to determine when a device is reachable.

The **no** variant of this command resets this command to the default.

Syntax `sample-size <1-100>`
`no sample size`

Parameter	Description
<1-100>	Number of pings that determines critical and up counts.

Default The default is 5.

Mode Ping-Polling Configuration

Examples To set the sample-size to 50 for ping-poll instance 43, use the commands:

```
awplus# configure terminal
awplus(config)# ping-poll 43
awplus(config-ping-poll)# sample-size 50
```

To reset sample-size to the default of 5 for ping-poll instance 43, use the commands:

```
awplus# configure terminal
awplus(config)# ping-poll 43
awplus(config-ping-poll)# no sample-size
```

**Related
commands**

- critical-interval
- fail-count
- normal-interval
- ping-poll
- show ping-poll
- timeout (ping polling)
- up-count

show counter ping-poll

Overview This command displays the counters for ping polling.

Syntax show counter ping-poll [*<1-100>*]

Parameter	Description
<i><1-100></i>	A unique ping poll ID number. This displays the counters for the specified ping poll only. If you do not specify a ping poll, then this command displays counters for all ping polls.

Mode User Exec and Privileged Exec

Output Figure 63-1: Example output from the **show counter ping-poll** command

```
Ping-polling counters
Ping-poll: 1
PingsSent          ..... 15
PingsFailedUpState ..... 0
PingsFailedDownState ..... 0
ErrorSendingPing   ..... 2
CurrentUpCount     ..... 13
CurrentFailCount   ..... 0
UpStateEntered     ..... 0
DownStateEntered   ..... 0

Ping-poll: 2
PingsSent          ..... 15
PingsFailedUpState ..... 0
PingsFailedDownState ..... 0
ErrorSendingPing   ..... 2
CurrentUpCount     ..... 13
CurrentFailCount   ..... 0
UpStateEntered     ..... 0
DownStateEntered   ..... 0

Ping-poll: 5
PingsSent          ..... 13
PingsFailedUpState ..... 0
PingsFailedDownState ..... 2
ErrorSendingPing   ..... 2
CurrentUpCount     ..... 9
CurrentFailCount   ..... 0
UpStateEntered     ..... 0
DownStateEntered   ..... 0
```

Table 64: Parameters in output of the **show counter ping-poll** command

Parameter	Description
Ping-poll	The ID number of the polling instance.
PingsSent	The total number of pings generated by the polling instance.
PingsFailedUpState	The number of unanswered pings while the target device is in the Up state. This is a cumulative counter for multiple occurrences of the Up state.
PingsFailedDownState	Number of unanswered pings while the target device is in the Down state. This is a cumulative counter for multiple occurrences of the Down state.
ErrorSendingPing	The number of pings that were not successfully sent to the target device. This error can occur when your device does not have a route to the destination.
CurrentUpCount	The current number of sequential ping replies.
CurrentFailCount	The number of ping requests that have not received a ping reply in the current sample-size window.
UpStateEntered	Number of times the target device has entered the Up state.
DownStateEntered	Number of times the target device has entered the Down state.

Example To display counters for the polling instances, use the command:

```
awplus# show counter ping-poll
```

Related commands

- [debug ping-poll](#)
- [ping-poll](#)
- [show ping-poll](#)

show ping-poll

Overview This command displays the settings and status of ping polls.

Syntax `show ping-poll [<1-100>|state {up|down}] [brief]`

Parameter	Description	
<1-100>	Displays settings and status for the specified polling instance.	
state	Displays polling instances based on whether the device they are polling is currently reachable or unreachable.	
	up	Displays polling instance where the device state is reachable.
	down	Displays polling instances where the device state is unreachable.
brief	Displays a summary of the state of ping polls, and the devices they are polling.	

Mode User Exec and Privileged Exec

Output Figure 63-2: Example output from the **show ping-poll brief** command

```
Ping Poll Configuration
-----
Id Enabled State Destination
-----
1 Yes Down 192.168.0.1
2 Yes Up 192.168.0.100
```

Table 65: Parameters in output of the **show ping-poll brief** command

Parameter	Meaning
Id	The ID number of the polling instance, set when creating the polling instance with the <code>ping-poll</code> command.
Enabled	Whether the polling instance is enabled or disabled.

Table 65: Parameters in output of the **show ping-poll brief** command (cont.)

Parameter	Meaning
State	The current status of the device being polled:
Up	The device is reachable.
Down	The device is unreachable.
Critical Up	The device is reachable but recently the polling instance has not received some ping replies, so the polled device may be going down.
Critical Down	The device is unreachable but the polling instance received a reply to the last ping packet, so the polled device may be coming back up.
Destination	The IP address of the polled device, set with the <code>ip (ping-polling)</code> command.

Figure 63-3: Example output from the **show ping-poll** command

```

Ping Poll Configuration
-----

Poll 1:
Description                : Primary Gateway
Destination IP address     : 192.168.0.1
Status                     : Down
Enabled                    : Yes
Source IP address         : 192.168.0.10
Critical interval         : 1
Normal interval           : 30
Fail count                : 10
Up count                  : 5
Sample size               : 50
Length                    : 32
Timeout                   : 1
Debugging                 : Enabled
  
```



```

Poll 2:
Description                : Secondary Gateway
Destination IP address     : 192.168.0.100
Status                     : Up
Enabled                   : Yes
Source IP address         : Default
Critical interval         : 5
Normal interval           : 60
Fail count                : 20
Up count                  : 30
Sample size               : 100
Length                    : 56
Timeout                   : 2
Debugging                 : Enabled
    
```

Table 66: Parameters in output of the **show ping-poll** command

Parameter	Description	
Description	Optional description set for the polling instance with the description (ping-polling) command.	
Destination IP address	The IP address of the polled device, set with the ip (ping-polling) command.	
Status	The current status of the device being polled:	
	Up	The device is reachable.
	Down	The device is unreachable.
	Critical Up	The device is reachable but recently the polling instance has not received some ping replies, so the polled device may be going down.
	Critical Down	The device is unreachable but the polling instance received a reply to the last ping packet, so the polled device may be coming back up.
Enabled	Whether the polling instance is enabled or disabled. The active (ping-polling) and active (ping-polling) commands enable and disable a polling instance.	
Source IP address	The source IP address sent in the ping packets. This is set using the source-ip command.	
Critical interval	The time period in seconds between pings when the polling instance has not received a reply to at least one ping, and when the device is unreachable. This is set with the critical-interval command.	
Normal interval	The time period between pings when the device is reachable. This is set with the normal-interval command.	

Table 66: Parameters in output of the **show ping-poll** command (cont.)

Parameter	Description
Fail count	The number of pings that must be unanswered, within the total number of pings specified by the sample-size command, for the polling instance to consider the device unreachable. This is set using the fail-count command.
Up count	The number of consecutive pings that the polling instance must receive a reply to before classifying the device reachable again. This is set using the up-count command.
Sample size	The total number of pings that the polling instance inspects when determining whether a device is unreachable. This is set using the sample-size command.
Length	The number of data bytes to include in the data portion of the ping packet. This is set using the length (ping-poll data) command.
Timeout	The time in seconds that the polling instance waits for a response to a ping packet. This is set using the timeout (ping polling) command.
Debugging	Indicates whether ping polling debugging is Enabled or Disabled . This is set using the debug ping-poll command.

Examples To display the ping poll settings and the status of all the polls, use the command:

```
awplus# show ping-poll
```

To display a summary of the ping poll settings, use the command:

```
awplus# show ping-poll brief
```

To display the settings for ping poll 6, use the command:

```
awplus# show ping-poll 6
```

To display a summary of the state of ping poll 6, use the command:

```
awplus# show ping-poll 6 brief
```

To display the settings of ping polls that have reachable devices, use the command:

```
awplus# show ping-poll state up
```

To display a summary of ping polls that have unreachable devices, use the command:

```
awplus# show ping-poll state down brief
```

Related commands [debug ping-poll](#)
[ping-poll](#)

source-ip

Overview This command specifies the source IP address to use in ping packets.

By default, the polling instance uses the address of the interface through which it transmits the ping packets. It uses the device's local interface IP address when it is set. Otherwise, the IP address of the interface through which it transmits the ping packets is used.

The **no** variant of this command resets the source IP in the packets to the device's local interface IP address.

Syntax `source-ip {<ip-address>|<ipv6-address>}`
`no source-ip`

Parameter	Description
<code><ip-address></code>	An IPv4 address in dotted decimal notation A.B.C.D
<code><ipv6-address></code>	An IPv6 address in hexadecimal notation X:X::X:X

Mode Ping-Polling Configuration

Examples To configure the ping-polling instance 43 to use the source IP address 192.168.0.1 in ping packets, use the commands:

```
awplus# configure terminal
awplus(config)# ping-poll 43
awplus(config-ping-poll)# source-ip 192.168.0.1
```

To configure the ping-polling instance 43 to use the source IPv6 address 2001:db8:: in ping packets, use the commands:

```
awplus# configure terminal
awplus(config)# ping-poll 43
awplus(config-ping-poll)# source-ip 2001:db8::
```

To reset the source IP address to the device's local interface IP address for ping-poll instance 43, use the commands:

```
awplus# configure terminal
awplus(config)# ping-poll 43
awplus(config-ping-poll)# no source-ip
```

Related commands

- description (ping-polling)
- ip (ping-polling)
- length (ping-poll data)
- ping-poll
- show ping-poll

timeout (ping polling)

Overview This command specifies the time in seconds that the polling instance waits for a response to a ping packet. You may find a higher time-out useful in networks where ping packets have a low priority.

The **no** variant of this command resets the set time out to the default of one second.

Syntax `timeout <1-30>`
`no timeout`

Parameter	Description
<1-30>	Length of time, in seconds, that the polling instance waits for a response from the polled device.

Default The default is 1 second.

Mode Ping-Polling Configuration

Examples To specify the timeout as 5 seconds for ping-poll instance 43, use the commands:

```
awplus# configure terminal
awplus(config)# ping-poll 43
awplus(config-ping-poll)# timeout 5
```

To reset the timeout to its default of 1 second for ping-poll instance 43, use the commands:

```
awplus# configure terminal
awplus(config)# ping-poll 43
awplus(config-ping-poll)# no timeout
```

Related commands

- [critical-interval](#)
- [fail-count](#)
- [normal-interval](#)
- [ping-poll](#)
- [sample-size](#)
- [show ping-poll](#)
- [up-count](#)

up-count

Overview This command sets the number of consecutive pings that the polling instance must receive a reply to before classifying the device reachable again.

The **no** variant of this command resets the up count to the default of 30.

Syntax `up-count <1-100>`
`no up-count`

Parameter	Description
<code><1-100></code>	Number of replied pings before an unreachable device is classified as reachable.

Default The default is 30.

Mode Ping-Polling Configuration

Examples To set the upcount to 5 consecutive pings for ping-polling instance 45, use the commands:

```
awplus# configure terminal
awplus(config)# ping-poll 45
awplus(config-ping-poll)# up-count 5
```

To reset the upcount to the default value of 30 consecutive pings for ping-polling instance 45, use the commands:

```
awplus# configure terminal
awplus(config)# ping-poll 45
awplus(config-ping-poll)# no up-count
```

Related commands

- [critical-interval](#)
- [fail-count](#)
- [normal-interval](#)
- [ping-poll](#)
- [sample-size](#)
- [show ping-poll](#)
- [timeout \(ping polling\)](#)

undebug ping-poll

Overview This command applies the functionality of the no `debug ping-poll` command.

Part 8: Firewall and Network Address Translation (NAT)

64

Firewall Commands

Introduction

Overview This chapter provides an alphabetical reference of commands used to configure AlliedWare Plus Firewall. For more information see the [Firewall_and Network Address Translation \(NAT\) Feature Overview and Configuration_Guide](#).

The table below lists the firewall commands and their applicable modes.

Figure 64-1: Firewall commands and applicable modes

Mode	Command
Privileged Exec	<code>clear firewall connections</code>
	<code>debug firewall</code>
	<code>show debugging firewall</code>
	<code>show firewall</code>
	<code>show firewall connections</code>
	<code>show firewall rule</code>
	<code>show firewall rule config-check</code>
	<code>show running-config firewall</code>
Global Configuration	<code>firewall</code>
Firewall Configuration	<code>protect (firewall)</code>
	<code>rule (firewall)</code>
	<code>move rule (firewall)</code>

- Command List**
- “[clear firewall connections](#)” on page 3471
 - “[connection-limit \(firewall\)](#)” on page 3472
 - “[connection-log events](#)” on page 3474

- [“firewall”](#) on page 3475
- [“debug firewall”](#) on page 3476
- [“ip tcp timeout established”](#) on page 3477
- [“move rule \(firewall\)”](#) on page 3478
- [“protect \(firewall\)”](#) on page 3479
- [“rule \(firewall\)”](#) on page 3480
- [“show connection-log events”](#) on page 3483
- [“show firewall”](#) on page 3484
- [“show firewall connections”](#) on page 3485
- [“show firewall connections limits”](#) on page 3486
- [“show firewall connections limits config-check”](#) on page 3487
- [“show firewall rule”](#) on page 3488
- [“show firewall rule config-check”](#) on page 3490
- [“show debugging firewall”](#) on page 3491
- [“show running-config firewall”](#) on page 3492

clear firewall connections

Overview Use this command to clear firewall connections.

Syntax `clear firewall connections`

Mode Privileged Exec

Usage notes Removing the Network Address Translation (NAT) rule by using the **no nat rule** command for an actively translated flow does not stop translating immediately. This means subsequent packets in the flow are continued to be translated.

The continued translation after associated NAT rule is removed will only stop when:

- You use the **clear firewall connections** command to manually stop translations immediately, when the associated rule has been deleted regardless whether the firewall feature is actually configured with NAT or not.
- The traffic flow ends naturally, for example, when it is stopped from the source. If the flow is re-initiated from a host, it will not be translated by the firewall, as the rule is deleted after the first flow stopped.

Examples To clear firewall connections, use the command:

```
awplus# clear firewall connections
```

Validation commands [show firewall connections](#)

Related commands [rule \(nat\)](#)

connection-limit (firewall)

Overview Use this command to limit firewall connections for an entity. The limit imposed by a connection-limit rule applies to the sum of TCP and UDP flows that match the rule.

You can use the tab key to auto-complete entity names.

Use the **no** variant of this command to remove the limit.

Syntax `connection-limit [<1-65535>] from <entity-name> with limit <0-100000>`
`no connection-limit {<1-65535>|all}`

Parameter	Description
<1-65535>	Unique numeric identifier for the limit.
<entity-name>	An entity represents a logical grouping of subnets, hosts or interfaces. For more information about entity, see the Application and Entity Commands .
<0-100000>	The maximum number of permitted connections for the entity.
all	Delete all limits.

Default The limiting is disabled by default and the number of connections will not be limited. However, the number is up to the maximum total number of allowed connections.

Mode Firewall Configuration

Usage notes This command allows you to limit the number of firewall sessions associated with a specific entity. The limit will be applied to each host on that entity. This means connection limits applied to an entity with multiple addresses will apply the limit to individual hosts, not the total connections for the entity. The limit applies to both IPv4 and IPv6.

If a connection limit rule is removed, any running connections are not stopped. Changes to limits only affect new connections. Adding a lower limit will not affect existing connections.

Examples To set a connection limit for entity DMZ, use the following command:

```
awplus(config-firewall)# connection-limit 1 from DMZ with limit 10000
```

To remove the connection limit, use the following command:

```
awplus(config-firewall)# no connection-limit 1
```

Validation commands `show firewall connections`
`show firewall connections limits`

Command changes Version 5.5.0-1.1: Firewall session limiting rules apply to UDP connections, where previously the limiting rules only applied to TCP connections.

connection-log events

Overview Use this command to enable extra logging for indicating the start and the end of connections passing through the firewall.

Use the **no** variant of this command to turn off the extra logging of connections passing through the firewall.

Syntax `connection-log events [new|end|all]`
`no connection-log events [new|end|all]`

Parameter	Description
new	New connection
end	Connections closed
all	All new connections and connections closed. Default.

Default Connection logging is not enabled by default.

Mode Global Configuration.

Usage notes There are two types of messages you can log: new connections and connections that ended. You can control the amount of messages you log by choosing to log either type of message or all of the message types.

Messages contain the following information:

- time
- source and destination addresses (NATed and unNATed)
- protocol
- source and destination ports (NATed and unNATed)
- bytes and packets passed (found in the connection end message)

Example To log all of the new connections and all of the closed connections, use the commands:

```
awplus# configure terminal
awplus(config)# connection-log events all
```

Related commands [show connection-log events](#)

Command changes Version 5.4.7-1.1: command added.

firewall

Overview Use this command to configure the firewall.
Use the **no** variant of this command to remove all firewall configuration.

Syntax `firewall`
`no firewall`

Mode Global Configuration

Usage notes This command allows you to enter the Firewall Configuration mode. The command prompt for this mode is **awplus(config-firewall)#**

In the Firewall Configuration mode, you can:

- Enable or disable firewall protection, see the [protect \(firewall\)](#) command.
- Create, move, or delete rules for the firewall, see the [rule \(firewall\)](#) command and the [move rule \(firewall\)](#) command.

Examples To configure the firewall, use the commands:

```
awplus# configure terminal
awplus(config)# firewall
awplus(config-firewall)#
```

To remove all firewall configuration, use the commands:

```
awplus# configure terminal
awplus(config)# no firewall
```

Validation commands [show firewall](#)
[show running-config firewall](#)

debug firewall

Overview Use this command to enable firewall debugging and Network Address Translation (NAT) debugging. This will cause additional detailed debugging information to be logged at the “informational” and “debugging” levels.

Use the **no** variant of this command to disable firewall debugging and NAT debugging.

For more information about NAT, see the [Firewall_and Network Address Translation \(NAT\) Feature Overview and Configuration_Guide](#).

Syntax debug firewall
no debug firewall

Default Firewall debugging and NAT debugging are disabled by default.

Mode Privileged Exec

Examples To enable firewall debugging and NAT debugging, use the command:

```
awplus# debug firewall
```

To disable firewall debugging and NAT debugging, use the command:

```
awplus# no debug firewall
```

Validation commands [show debugging firewall](#)

ip tcp timeout established

Overview Use this command to set the idle timeout for all established TCP connections. Use the **no** variant of this command to set the idle timeout back to the default of 3600 seconds.

Syntax `ip tcp timeout established <1-31536000>`
`no ip tcp timeout established`

Parameter	Description
<code><1-31536000></code>	Idle timeout for established TCP connections in seconds from 1 to 3153600.

Default 3600 seconds (1 hour)

Mode Global Configuration

Usage notes By default, when a TCP session is successfully established through the firewall, when the session goes idle, it automatically times out of the firewall connection tracking table after 3600 seconds. In some situations it may be beneficial to time out unused established TCP sessions earlier.

For example, in a busy environment where there is an excessive number of sessions being established, the firewall connection tracking table could become oversubscribed, with new connections being blocked until older sessions are timed out.

Example To set a non-default TCP session timeout for established idle sessions of 1800 seconds (30 minutes), use the commands:

```
awplus# configure terminal
awplus(config)# ip tcp timeout established 1800
```

Example To set the TCP session timeout for established idle sessions back to the default setting of 3600 seconds, use the commands:

```
awplus# configure terminal
awplus(config)# no ip tcp timeout established
```

Related commands [show running-config](#)

Command changes Version 5.4.6-1.1: command added

move rule (firewall)

Overview Use this command to change the order of firewall rules.

Firewall rules are applied in rule ID order. When rules match the same application, source entity and destination entity, only the rule with the lowest ID is applied.

Note that you can move an existing rule ID only to an ID that is not assigned to any rule; otherwise you will be given an error message. Also note that a change to the rule order may change the rule results.

Syntax `move rule <1-65535> to <1-65535>`

Parameter	Description
<code>move rule <1-65535></code>	Move the ID of a given rule. The rule ID of the given rule must exist. Each rule has an ID which is either designated by the user or automatically generated when the rule is created. The rule ID is an integer from 1 to 65535.
<code>to <1-65535></code>	New rule ID to assign. The new rule ID must not be used by any existing rule.

Mode Firewall Configuration

Examples To change the rule ID from 20 to 10, use the commands:

```
awplus# configure terminal
awplus(config)# firewall
awplus(config-firewall)# move rule 20 to 10
```

Validation commands `show firewall rule`
`show running-config firewall`

Related commands `rule (firewall)`

protect (firewall)

Overview Use this command to enable firewall protection.

Use the **no** variant of this command to disable firewall protection without losing the existing firewall configuration.

Syntax `protect`
`no protect`

Default Firewall protection is disabled by default.

Mode Firewall Configuration

Usage notes Firewall protection is disabled by default and all traffic can pass through the firewall. When the firewall is enabled and no rules are added, all traffic will be blocked by default. You can use the [rule \(firewall\)](#) command to configure rules to allow traffic to pass through the firewall.

Examples To enable firewall protection, use the commands:

```
awplus# configure terminal
awplus(config)# firewall
awplus(config-firewall)# protect
```

To disable firewall protection, use the commands:

```
awplus# configure terminal
awplus(config)# firewall
awplus(config-firewall)# no protect
```

Validation commands [show firewall](#)
[show running-config firewall](#)

rule (firewall)

Overview Use this command to create a rule for the firewall. Firewall security policy is specified in the form of firewall rules. Each rule defines the appropriate processing of a type of traffic passing through the firewall.

Use the **no** variant of this command to remove a rule.

Syntax rule [*<1-65535>*] {permit|deny|reject|log} *<application-name>*
from *<source-entity>* to *<destination-entity>*
[no-state-enforcement] [log]
no rule {*<1-65535>*|all}

Parameter	Description
<i><1-65535></i>	Rule ID is an integer in the range <i><1-65535></i> . If you don't designate a rule ID, a rule ID will be automatically generated and it will be greater than the current highest rule ID.
permit	Permit connections that match the application, source entity and destination entity specified with this command.
deny	Drop connections that match the application, source entity and destination entity specified with this command. No error message is sent back to the source host.
reject	Reject connections that match the application, source entity and destination entity specified with this command. An error message (for instance, a TCP reset for a rejected TCP connection, or a destination unreachable message for an ICMP connection, etc.) is sent back to the source host.
log	When 'log' is the action for the rule, log an event each time the rule is hit. The traffic will also be processed by subsequent firewall rules which may permit, deny or reject the connection.
<i><application-name></i>	Application name. You can either specify an application name or use the word any , which stands for all applications. For more information about applications, see Application and Entity Commands. You can use the tab key to auto-complete application names.

Parameter	Description
<code><source-entity></code>	Source entity name. An entity represents a logical grouping of subnets, hosts or interfaces. For more information about entities, see Application and Entity Commands. You can use the tab key to auto-complete entity names.
<code><destination-entity></code>	Destination entity name.
<code>no-state-enforcement</code>	Optionally disable state enforcement for this rule. Use this option with caution as it will allow reverse path connection initiation. It should be used only when the traffic forward and reverse paths must be different and there is no alternative approach available. This option is disabled by default.
<code>log</code>	When 'log' is appended to a rule, the action is applied and a log message is also generated each time the rule is hit.
<code>all</code>	Delete all rules.

Mode Firewall Configuration

Usage notes When the firewall is enabled and no rules are added, all traffic is blocked by default, you can use this command to create rules for permitting packets between entities.

The rule is not valid and cannot be hit if either the application, source entity or destination entity the rule applies to is not properly configured, for example, the application does not exist or does not have a protocol configured or the entity does not exist. To configure applications and entities, see Application and Entity Commands. You can also use the [show firewall rule config-check](#) command to check rule configuration validity.

You can change the rule order by using the [move rule \(firewall\)](#) command.

Examples To create a rule for permitting application ping between 'public' and 'private', use the command:

```
awplus(config-firewall)# rule 10 permit
ping from public to private
```

To create a rule for denying application http between 'public.wan' and 'private.lan', use the command:

```
awplus(config-firewall)# rule 20 deny
http from public.wan to private.lan
```

To create a firewall rule to permit application 'ping' between 'public' and 'dmz' entities and to log the results, use the commands:

```
awplus(config-firewall)# rule 30 permit
ping from public to dmz log
```

Related commands `move rule (firewall)`
 `show firewall rule`
 `show firewall rule config-check`

Command changes Version 5.4.7-0.1: **no-state-enforcement** option added.

show connection-log events

Overview This command displays the configuration state (enabled or disabled) for the logging of connections passing through the firewall, as configured by the [connection-log events](#) command.

Syntax `show connection-log events`

Mode User Exec

Example To show the logging configuration state for the connections passing through the firewall, use the command:

```
awplus# show connection-log events
```

Output Figure 64-2: Example output from **show connection-log events**

```
awplus#show connection-log events
Log new connection events:      Disabled
Log connection end events:     Enabled
```

Related commands [connection-log events](#)

Command changes Version 5.4.7-1.1: command added.

show firewall

Overview Use this command to show the protection state of the firewall and the number of active connections being handled by the firewall.

You can use the [protect \(firewall\)](#) command to enable firewall protection.

Syntax `show firewall`

Mode Privileged Exec

Examples To show the state of the firewall, use the command:

```
awplus# show firewall
```

Output Figure 64-3: Example output from the **show firewall** command

```
awplus#show firewall
Firewall protection is enabled
Active connections: 9
```

Related commands [protect \(firewall\)](#)

show firewall connections

Overview Use this command to show the connections currently being tracked by the firewall.

Syntax show firewall connections

Mode Privileged Exec

Examples To show the connections currently being tracked by the firewall, use the command:

```
awplus# show firewall connections
```

Output Figure 64-4: Example output from the **show firewall connections** command

```
awplus#show firewall connections
tcp ESTABLISHED src=192.168.1.2 dst=172.16.1.2 sport=58616
dport=23 packets=16
bytes=867 src=172.16.1.2 dst=172.16.1.1 sport=23 dport=58616
packets=11 bytes=636
[ASSURED]
icmpv6 src=2001:db8::2 dst=2001:db8::1 type=128 code=0 id=1416
packets=34
bytes=3536 src=2001:db8::1 dst=2001:db8::2 type=129 code=0 id=1416
packets=34
bytes=3536
tcp TIME_WAIT src=2001:db8:1::2 dst=2001:db8:2::2 sport=42532
dport=80 packets=7
bytes=597 src=2001:db8:2::2 dst=2001:db8:1::2 sport=80 dport=42532
packets=5
bytes=651 [ASSURED]
tcp TIME_WAIT src=2001:db8:1::2 dst=2001:db8:2::2 sport=48740
dport=80 packets=5
bytes=564 src=2001:db8:2::2 dst=2001:db8:1::2 sport=80 dport=48740
packets=5
bytes=594 [ASSURED]
```

Related commands [clear firewall connections](#)

show firewall connections limits

Overview Use this command to show the configured firewall connection-limits for a given entity.

Syntax `show firewall connections limits`

Mode Privileged Exec

Examples To show the information about all the firewall connection limits, use the command:

```
awplus# show firewall connections limits
```

Output Figure 64-5: Example output from the **show firewall connections limits** command

```
awplus#show firewall connections limits
```

ID	Entity	Limit	Hit Count
10	DMZ	100	42

Related commands [show firewall connections limits config-check](#)

show firewall connections limits config-check

Overview Use this command to check configuration validity of firewall connection limits.

An invalid rule will not be active and cannot be hit. This command also shows the reasons why a limit configuration is not valid.

Syntax `show firewall connections limits config-check`

Mode Privileged Exec

Usage notes Firewall limits are applied to entities only. A limit is not valid if the source entity (zone) is not configured properly. This command checks if the entity exists at all, and if it does it also checks if the entity (zone) has a valid subnet.

Examples To check configuration validity of connection-limit rules, use the command:

```
awplus# show firewall connections limits  
config-check
```

Output Figure 64-6: Example output from the **show firewall connections limits config-check** command on the console if rule configuration errors are detected. Connection-limit 10 uses an entity that exists; however no subnet has been specified. Connection-limit 20 uses an entity that doesn't exist.

```
awplus#show firewall connections limits config-check  
Connection-limit 10:  
  "From" entity has no subnet or host addresses  
Connection-limit 20:  
  "From" entity does not exist
```

Output Figure 64-7: Example output from the **show firewall connections limits config-check** command if all limit rules are valid

```
awplus#show firewall connection limits config-check  
All rules are valid
```

Related commands [show firewall connections limits](#)

show firewall rule

Overview Use this command to show information about firewall rules.

Syntax show firewall rule [*<1-65535>*]

Parameter	Description
<i><1-65535></i>	Rule ID

Mode Privileged Exec

Examples To show information about all firewall rules, use the command:

```
awplus# show firewall rule
```

Output Figure 64-8: Example output from the **show firewall rule** command

```
awplus#show firewall rule

[* = Rule is not valid - see "show firewall rule config-check"]
  ID    Action  App      From      To        Hits
-----
  10    permit  ping     public    private    0
  20    permit  ping     public    dmz        0
  40    permit  ping     private   dmz        0
 * 50    permit  voice    public    private    0
```

To show information about a specific firewall rule, use the command:

```
awplus# show firewall rule 10
```

Output Figure 64-9: Example output from the **show firewall rule** command

```
awplus#show firewall rule 10

[* = Rule is not valid - see "show firewall rule config-check"]
  ID    Action  App      From      To        Hits
-----
  10    permit  ping     public    private    0
```

Output Parameter	Description
*	Indicates the rule is not valid and cannot be hit. See the show firewall rule config-check command.
Action	The rule action set by the rule (firewall) command.
App	Application name.

Output Parameter	Description
From	Source entity.
To	Destination entity.
Hits	The number of times the firewall rule has been hit.

Related commands [rule \(firewall\)](#)

show firewall rule config-check

Overview Use this command to check configuration validity of firewall rules.
An invalid rule will not be active and cannot be hit. This command also shows the reasons why a rule is not valid.

Syntax `show firewall rule config-check`

Mode Privileged Exec

Usage notes Firewall rules are applied to applications and entities. A rule is not valid if either the application, source entity or destination entity the rule applies to is not configured properly.

To configure applications and entities, see Application and Entity Commands.

Examples To check configuration validity of firewall rules, use the command:

```
awplus# show firewall rule config-check
```

Output Figure 64-10: Example output from the **show firewall rule config-check** command if rule configuration errors are detected

```
awplus#show firewall rule config-check
Rule 10:
  Application does not have a protocol configured
  "From" entity does not exist
  "To" entity has no subnet or host addresses
```

Output Figure 64-11: Example output from the **show firewall rule config-check** command if all rules are valid

```
awplus#show firewall rule config-check
All rules are valid
```

Related commands [rule \(firewall\)](#)
[show firewall rule](#)

show debugging firewall

Overview Use this command to see what debugging is turned on for firewall and Network Address Translation (NAT).

You can use the [debug firewall](#) command to enable firewall and NAT debugging.

For more information about NAT, see the [Firewall_and Network Address Translation \(NAT\) Feature Overview and Configuration_Guide](#).

Syntax `show debugging firewall`

Mode Privileged Exec

Examples To show the firewall and NAT debugging status, use the command:

```
awplus# show debugging firewall
```

Output Figure 64-12: Example output from the **show debugging firewall** command

```
awplus#show debugging firewall
Firewall Debugging Status: on
```

Related commands [debug firewall](#)

show running-config firewall

Overview Use this command to show the configuration commands that have been used to configure the firewall.

Syntax `show running-config firewall`

Mode Privileged Exec

Examples To show the configuration commands that have been used to configure the firewall, use the command:

```
awplus# show running-config firewall
```

Output Figure 64-13: Example output from the **show running-config firewall** command

```
awplus#show running-config firewall
firewall
  rule 10 permit ping from public to private
  protect
!
```

65

Application and Entity Commands

Introduction

Overview This chapter provides an alphabetical reference of commands used to configure application and entity. For more information, see the [Firewall_and Network Address Translation \(NAT\) Feature Overview and Configuration_Guide](#).

The table below lists the application commands and their applicable modes.

Figure 65-1: Application commands and applicable modes

Mode	Command
Privileged Exec	<code>show application</code>
	<code>show application detail</code>
Global Configuration	<code>application</code>
Application Mode	<code>protocol</code>
	<code>icmp-type</code>
	<code>icmp-code</code>
	<code>sport</code>
	<code>dport</code>

The table below lists the entity commands and their applicable modes.

Figure 65-2: Entity commands

Mode	Command
Privileged Exec	<code>show entity</code>
Global Configuration	<code>zone</code>
Zone Mode	<code>network (zone)</code>

Mode	Command
Network Mode	<code>ip subnet</code>
	<code>ipv6 subnet</code>
	<code>host (network)</code>
Host Mode	<code>ip address (host)</code>
	<code>ipv6 address (host)</code>

- Command List**
- `"application"` on page 3495
 - `"dport"` on page 3497
 - `"dscp"` on page 3499
 - `"host (network)"` on page 3501
 - `"icmp-code"` on page 3503
 - `"icmp-type"` on page 3505
 - `"ip address (host)"` on page 3507
 - `"ip subnet"` on page 3509
 - `"ipv6 address (host)"` on page 3511
 - `"ipv6 subnet"` on page 3513
 - `"network (zone)"` on page 3515
 - `"protocol"` on page 3517
 - `"show application"` on page 3518
 - `"show application detail"` on page 3519
 - `"show entity"` on page 3521
 - `"sport"` on page 3524
 - `"zone"` on page 3526

application

Overview Use this command to create or modify a custom application.

An application is a high level abstraction of application packets being transported by network traffic. Traffic matching for applications can be achieved by using several techniques, for example, matching packets to port numbers or searching for application signatures in flows of packets.

You can use the tab key to auto-complete application names.

Use the **no** variant of this command to delete a custom application.

Syntax `application <application-name>`
`no application <application-name>`

Parameter	Description
<code><application-name></code>	Application name. You can use all alphanumeric ASCII characters, and the dash (-) and underscore (_) characters. The name can be 1 to 64 characters long. The application name is case-sensitive. If you create two application names with the same spelling but one in upper case and the other one in lower case, the last overwrites the first entry.

Mode Global Configuration

Usage notes Use this command to enter the Application Configuration mode, to create a custom application or configure an existing application. You can configure the source port, destination port, protocol, ICMP code and ICMP type for the application. An application is invalid if its protocol, source or destination are not properly configured, for example, if the application has no protocol configured, or source and destination ports are applied to protocols that are not TCP, UDP or SCTP.

There are 40 predefined applications with protocols, source and destination ports.

You can change the protocol, source and destination ports of the predefined applications. You can only delete the predefined application when you change either its protocol, source or destination port.

Use the [show application](#) command to show all the custom and predefined applications.

Examples To create a custom application named 'isakmp', use the commands:

```
awplus# configure terminal
awplus(config)# application isakmp
awplus(config-application)#
```

To delete the custom application named 'isakmp', use the commands:

```
awplus# configure terminal  
awplus(config)# no application isakmp
```

**Related
commands**

dport
icmp-code
icmp-type
protocol
show application
sport

dport

Overview Use this command to specify a destination port or port range for an application.

A port number is part of the addressing information used to identify a specific process to which a network message is to be forwarded between a sender and a receiver. For the full list of port numbers and their assignment, you can visit the Internet Assigned Numbers Authority (IANA) website at www.iana.org.

Use the **no** variant of this command to delete a port or a port range from an application. Note that the port or port range that you want to delete must match exactly the existing port or port range. You cannot remove a port range that is part of an existing port range.

Syntax `dport {<destination-port>|any|<start-range> to <end-range>}`
`no dport {<destination-port>|any|<start-range> to <end-range>}`

Parameter	Description
<code><destination-port></code>	The destination port number, either TCP or UDP, specified as an integer in the range <1-65535>.
<code>any</code>	Any port number in the range <1-65535>. This equals to a range of 1 to 65535.
<code><start-range></code>	Starting port number in the range <1-65535>.
<code>to <end-range></code>	Ending port number in the range <1-65535> or max .

Mode Application Mode

Usage notes You can have up to 15 **dports** per application. This is counted as follows:

- a single **dport** counts as 1 port
- a range counts as 2 ports
- the keyword **any** counts as 2 ports.

Examples To specify destination port 500 for the application named isakmp, use the commands:

```
awplus# configure terminal
awplus(config)# application isakmp
awplus(config-application)# dport 500
```

To specify destination port 500 and a range of ports for the application named **isakmp**, use the commands:

```
awplus# configure terminal
awplus(config)# application isakmp
awplus(config-application)# dport 500
awplus(config-application)# dport 60000 to max
```

To specify the destination port **any** (a port number range of 1-65535) for the application named **isakmp**, use the commands:

```
awplus# configure terminal
awplus(config)# application isakmp
awplus(config-application)# dport any
```

To remove destination port 500 from the application named **isakmp**, use the commands:

```
awplus# configure terminal
awplus(config)# application isakmp
awplus(config-application)# no dport 500
```

To remove port **any** from the application **isakmp**, use the commands:

```
awplus# configure terminal
awplus(config)# application isakmp
awplus(config-application)# no dport 1 to 65535
```

**Related
commands**

[application](#)
[sport](#)
[show application](#)

dscp

Overview Use this command to specify one or more DSCP values used by an application.

Use the **no** variant of this command to remove one or more DSCP values from an application.

Syntax

```
dscp <dscp-list>

dscp {af11|af12|af13|af21|af22|af23|af31|af32|af33|af41|af42|af43|ef|be}

dscp {cs0|cs1|cs2|cs3|cs4|cs5|cs6|cs7}

no dscp

no dscp <dscp-list>

no dscp {af11|af12|af13|af21|af22|af23|af31|af32|af33|af41|af42|af43|ef|be}

no dscp {cs0|cs1|cs2|cs3|cs4|cs5|cs6|cs7}
```

Parameter	Description
<dscp-list>	One or more DSCP values, in the range 0-63. Use spaces to separate values.
af11 ... be	One or more DSCP values specified according to the Assured Forwarding group, as defined in RFC 2597 and RFC 3260. See the table below for values. "ef" means expedited forwarding (DSCP 46) and "be" means best effort (DSCP 0). Voice traffic is typically given a value of ef.
cs0 ... cs7	One or more DSCP values specified according to the Class Selector group. This is equivalent to TOS IP precedence values, so that CS0 is equivalent to an IP precedence value of 0, CS1 is equivalent to an IP precedence value of 1, and so on.

Table 65-1: Assured Forwarding (AF) behavior group

	Class 1	Class 2	Class 3	Class 4
Low drop probability	AF11 (DSCP 10)	AF21 (DSCP 18)	AF31 (DSCP 26)	AF41 (DSCP 34)
Medium drop probability	AF12 (DSCP 12)	AF22 (DSCP 20)	AF32 (DSCP 28)	AF42 (DSCP 36)
High drop probability	AF13 (DSCP 14)	AF23 (DSCP 22)	AF33 (DSCP 30)	AF43 (DSCP 38)

Mode Application Mode

Usage notes You can specify only one set of DSCP values for an application. The newly specified list will replace the existing one; it will not be added to the existing one.

Example To specify a DSCP of **ef** for the application named **voice**, use the commands:

```
awplus# configure terminal
awplus(config)# application voice
awplus(config-application)# dscp ef
```

To specify DSCPs of 12 and 13 for the application named **test**, use the commands:

```
awplus# configure terminal
awplus(config)# application test
awplus(config-application)# dscp 12 13
```

To remove DSCP12 from the application named **test**, use the commands:

```
awplus# configure terminal
awplus(config)# application test
awplus(config-application)# no dscp 12
```

To stop the application named **test** from using DSCP values, use the commands:

```
awplus# configure terminal
awplus(config)# application test
awplus(config-application)# no dscp
```

Related commands

- [application](#)
- [show application](#)
- [show application detail](#)

host (network)

Overview Use this command to add a host to a network entity or to configure an existing host.

Host is a high level abstraction of a single node in a network. This is commonly used if a particular device, for example a server, has a static IP address that needs to be specified in a firewall policy.

Use the **no** variant of this command to remove a host from a network entity.

Syntax `host <host-name>`
`no host <host-name>`

Parameter	Description
<code><host-name></code>	Host name. You can use all alphanumeric ASCII characters, and the dash (-) and underscore (_) characters. The name can be 1 to 64 characters in long.

Mode Network Mode

Usage notes You can create multiple hosts for a network. A host entity is identified by its parent network using the dot notation, for example, `ZoneName.NetworkName.HostName`.

This commands allows you to enter the Host Mode with the prompt **awplus(config-host)#**. The Host Mode enables you to configure IPv4 address and IPv6 address for the host. For more information about host IPv4 address and IPv6 address, see [ip address \(host\)](#) command and [ipv6 address \(host\)](#) command respectively.

Example To create a host entity named `ftp` under network entity `servers`, use the commands:

```
awplus# configure terminal
awplus(config)# zone dmz
awplus(config-zone)# network servers
awplus(config-network)# host ftp
awplus(config-host)#
```

To remove host entity `ftp` and its IP address configuration from network entity `servers`, use the commands:

```
awplus# configure terminal
awplus(config)# zone dmz
awplus(config-zone)# network servers
awplus(config-network)# no host ftp
```

**Validation
commands** show entity

**Related
commands** ip address (host)
 ipv6 address (host)
 network (zone)

icmp-code

Overview Use this command to configure an ICMP message code for an application.

ICMP has many messages that are identified by a “type” field and many of these ICMP types have a “code” field. Use the `icmp-type` command to specify the ICMP type. For the full list of the ICMP code assignments, you can visit the Internet Assigned Numbers Authority (IANA) website at www.iana.org.

Use the **no** variant of this command to restore the ICMP message code to its default, which is **any**.

Syntax `icmp-code {<code-number>|any}`
`no icmp-code`

Parameter	Description
<code><code-number></code>	Specify an ICMP message code number in the range of 0 to 255.
<code>any</code>	Any ICMP message code in the range of 0 to 255.

Default The default ICMP code number is **any**.

Mode Application Mode

Usage notes You should configure the ICMP code only for applications that use protocol ICMP. To configure the application protocol, see the `protocol` command.

You can specify only one ICMP message code for an application. The newly specified code will replace the previous one.

Examples To specify ICMP code 5 (redirect) for the application named `icmp`, use the commands:

```
awplus# configure terminal
awplus(config)# application icmp
awplus(config-application)# icmp-code 5
```

To specify the ICMP code as **any** for the application named `icmp`, use the commands:

```
awplus# configure terminal
awplus(config)# application icmp
awplus(config-application)# icmp-code any
```

To restore the ICMP message code to its default of **any** for the application named `icmp`, use the commands:

```
awplus# configure terminal
awplus(config)# application icmp
awplus(config-application)# no icmp-code
```

**Related
commands** application
icmp-type
protocol
show application

icmp-type

Overview Use this command to configure an ICMP message type for an application.

The ICMP protocol has many messages that are identified by a “type” field. For the full list of the ICMP type assignments, you can visit the Internet Assigned Numbers Authority (IANA) website at www.iana.org.

Use the **no** variant of this command to restore the ICMP message type to its default, which is **any**.

Syntax icmp-type {<type-number>|any}
no icmp-type

Parameter	Description
<type-number>	Specify an ICMP message type number in the range of 0 to 255.
any	Any ICMP message type in the range of 0 to 255.

Default The default ICMP type is **any**.

Mode Application Mode

Usage notes You should configure the ICMP type only for applications that use protocol ICMP. To configure the application protocol, see the [protocol](#) command.

You can specify only one ICMP message type for an application. The newly specified type will replace the previous one.

Examples To specify ICMP message type 8 (echo) for the application named icmp, use the commands:

```
awplus# configure terminal
awplus(config)# application icmp
awplus(config-application)# icmp-type 8
```

To specify the ICMP message type as **any** for the application named icmp, use the commands:

```
awplus# configure terminal
awplus(config)# application icmp
awplus(config-application)# icmp-type any
```

To restore the ICMP message type to its default of **any** for the application named icmp, use the commands:

```
awplus# configure terminal
awplus(config)# application icmp
awplus(config-application)# no icmp-type
```

**Related
commands** application
icmp-code
network (zone)
show application

ip address (host)

Overview Use this command to assign an IPv4 address to a host entity.
Use the **no** variant of this command to remove an IPv4 address from the host.

Syntax

```
ip address <ipv4-address>
ip address dynamic fqdn <domain_name>
ip address dynamic interface <interface_name>
no ip address <ipv4-address>
no ip address dynamic fqdn <domain_name>
no ip address dynamic interface <interface_name>
```

Parameter	Description
<ipv4-address>	The IPv4 address uses the format A.B.C.D.
dynamic	Dynamic IP address, for example, obtained from a DHCP server.
<domain_name>	The FQDN to resolve IP addresses for.
<interface_name>	Interface to acquire IP addresses from.

Mode Host

Usage notes You can add multiple IP addresses to a host entity. If the IP address is not in the scope of any of its parent network's IPv4 subnets, a warning message will be given. Such an IP address is still acceptable because in the future the user may assign a network subnet that contains the host's IP address. Firewall policy rules will not apply to an IP address that is not in at least one of the network's subnets.

If you are adding an FQDN, DNS Relay cache and **ip domain-lookup via-relay** must be enabled for this command to work. DNS requests passing through the router are inspected for matching FQDNs. Because of this, the DNS cache is cleared when this command is entered so that the IP addresses can be picked up.

You can add multiple dynamic FQDNs for a host entity.

Examples To add an IP address to host ftp, use the commands:

```
awplus# configure terminal
awplus(config)# zone dmz
awplus(config-zone)# network servers
awplus(config-network)# ip subnet 192.168.1.0/24
awplus(config-network)# host ftp
awplus(config-host)# ip address 192.168.1.5
```

To add multiple IP addresses to host ftp, use the commands:

```
awplus# configure terminal
awplus(config)# zone dmz
awplus(config-zone)# network servers
awplus(config-network)# ip subnet 192.168.1.0/24
awplus(config-network)# host ftp
awplus(config-host)# ip address 192.168.1.8
awplus(config-host)# ip address 192.168.1.9
awplus(config-host)# ip address 192.168.1.10
```

To add the IPv4 addresses of the FQDN "google.com" to a zone, use the following commands:

```
awplus# configure terminal
awplus(config)# zone Public
awplus(config-zone)# network Router
awplus(config-network)# ip subnet 0.0.0.0/0
awplus(config-network)# host google
awplus(config-host)# ip address dynamic fqdn google.com
```

To remove an IP address from host ftp, use the commands:

```
awplus# configure terminal
awplus(config)# zone dmz
awplus(config-zone)# network servers
awplus(config-network)# host ftp
awplus(config-host)# no ip address 192.168.1.5
```

Validation commands [show entity](#)

Related commands [host \(network\)](#)
[ip domain-lookup](#)

Command changes Version 5.4.8-1.1: FQDN parameter and output added

ip subnet

Overview Use this command to add an IPv4 subnet to a network entity.
Use the **no** variant of this command to remove a subnet from a network entity.

Syntax `ip subnet <ip-network/m> [interface <interface-name>]`
`no ip subnet <ip-network/m> [interface <interface-name>]`

Parameter	Description
<code><ip-network/m></code>	IP address of the network, entered in the form A.B.C.D/M. Dotted decimal notation followed by a forward slash, and then the subnet mask length.
<code>interface</code>	Specify an interface name. An interface may be specified to add a further restriction on the subnet. No interface configured indicates that any matching address from any interface is a member of this network.
<code><interface-name></code>	Interface name. Any AlliedWare Plus interface type (eth, vlan, ppp, tunnel, lo, etc.) followed by any character. A warning message is given if the interface does not match an existing interface on the device.

Mode Network Mode

Usage notes You can create multiple subnets to a network entity.

Examples To add a subnet to network 'servers', use the commands:

```
awplus# configure terminal
awplus(config)# zone dmz
awplus(config-zone)# network servers
awplus(config-network)# ip subnet 192.168.2.0/24
```

To add a subnet and an interface to network 'servers', use the commands:

```
awplus# configure terminal
awplus(config)# zone dmz
awplus(config-zone)# network servers
awplus(config-network)# ip subnet 192.168.2.0/24 interface eth1
```

To add multiple subnets to network 'servers', use the commands:

```
awplus# configure terminal
awplus(config)# zone dmz
awplus(config-zone)# network servers
awplus(config-network)# ip subnet 192.168.2.0/24 interface eth1
awplus(config-network)# ip subnet 10.1.0.0/16 interface eth1
```

To remove a subnet from network 'servers', use the commands:

```
awplus# configure terminal
awplus(config)# zone dmz
awplus(config-zone)# network servers
awplus(config-network)# no ip subnet 192.168.2.0/24
```

Related commands [network \(zone\)](#)
[show entity](#)

ipv6 address (host)

Overview Use this command to assign an IPv6 address to a host entity.
Use the **no** variant of this command to remove an IPv6 address from an host entity.

Syntax

```
ipv6 address <ipv6-address>  
ipv6 address dynamic fqdn <domain_name>  
ipv6 address dynamic interface <interface_name>  
no ipv6 address <ipv6-address>  
no ipv6 address dynamic fqdn <domain_name>  
no ipv6 address dynamic interface <interface_name>
```

Parameter	Description
<ipv6-address>	The IPv6 address in the format x:x::x:x.
dynamic	Dynamic IPv6 address, for example, obtained from a DHCP server.
<domain_name>	The FQDN to resolve IP addresses for.
<interface_name>	Interface to acquire IP addresses from.

Mode Host Mode

Usage notes You can add multiple IPv6 addresses to a host entity. If the IPv6 address is not in the scope of any of its parent network's IPv6 subnets, a warning message will be given. Such an IP address is still acceptable because in the future the user may assign a network subnet that contains the host's IPv6 address. Firewall policy rules will not apply to an IPv6 address that is not in at least one of the network's subnets.

If you are adding an FQDN, DNS Relay cache and **ip domain-lookup via-relay** must be enabled for this command to work. DNS requests passing through the router are inspected for matching FQDNs. Because of this, the DNS cache is cleared when this command is entered so that the IPv6 addresses can be picked up.

You can add multiple dynamic FQDNs for a host entity.

Examples To add an IPv6 address to host `web-server`, use the commands:

```
awplus# configure terminal  
awplus(config)# zone dmz  
awplus(config-zone)# network servers  
awplus(config-network)# ipv6 subnet 2001:db8:24:100::/64  
awplus(config-network)# host web-server  
awplus(config-host)# ipv6 address 2001:db8:24:100::1
```

To add multiple IP addresses to host `web-server`, use the commands:

```
awplus# configure terminal
awplus(config)# zone dmz
awplus(config-zone)# network servers
awplus(config-network)# ipv6 subnet 2001:db8:24:100::/64
awplus(config-network)# host web-server
awplus(config-host)# ipv6 address 2001:db8:24:100::2
awplus(config-host)# ipv6 address 2001:db8:24:100::3
awplus(config-host)# ipv6 address 2001:db8:24:100::4
```

To add the IPv6 addresses of the FQDN "google.com" to a zone, use the following commands:

```
awplus# configure terminal
awplus(config)# zone Public
awplus(config-zone)# network Router
awplus(config-network)# ip subnet ::/0
awplus(config-network)# host google
awplus(config-host)# ip address dynamic fqdn google.com
```

To remove an IPv6 address from host `web-server`, use the commands:

```
awplus# configure terminal
awplus(config)# zone dmz
awplus(config-zone)# network servers
awplus(config-network)# host web-server
awplus(config-host)# no ipv6 address 2001:db8:24:100::2
```

Validation commands [show entity](#)

Related commands [host \(network\)](#)
[ip domain-lookup](#)

Command changes Version 5.4.8-1.1: FQDN parameter and output added

ipv6 subnet

Overview Use this command to assign an IPv6 subnet to a network entity.
Use the **no** variant of this command to remove a IPv6 subnet from a network entity.

Syntax `ipv6 subnet <ip-network/m> [interface <interface-name>]`
`no ipv6 subnet <ip-network/m> [interface <interface-name>]`

Parameter	Description
<code><ip-network/m></code>	IPv6 address of the network, entered in the form X:X::X/M, followed by the prefix length in slash notation.
<code>interface</code>	Specify an interface name. An interface may be specified to add a further restriction on the subnet. No interface configured indicates that any matching address from any interface is a member of this network.
<code><interface-name></code>	Interface name. Any AlliedWare Plus interface type (eth, vlan, ppp, tunnel, lo, etc.) followed by any character. A warning message is given if the interface does not match an existing interface on the device.

Mode Network Mode

Usage notes You can create multiple subnets for a network entity.

Examples To add a subnet to network 'servers', use the commands:

```
awplus# configure terminal
awplus(config)# zone dmz
awplus(config-zone)# network servers
awplus(config-network)# ipv6 subnet 2001:db8::/32
```

To add a subnet and an interface to network 'servers', use the commands:

```
awplus# configure terminal
awplus(config)# zone dmz
awplus(config-zone)# network servers
awplus(config-network)# ipv6 subnet 2001:db8::/32 interface eth1
```

To add multiple subnets to network 'servers', use the commands:

```
awplus# configure terminal
awplus(config)# zone dmz
awplus(config-zone)# network servers
awplus(config-network)# ipv6 subnet 2001:db8::7/32 interface
eth1
awplus(config-network)# ipv6 subnet 2001:db8::8/32 interface
eth1
```

To remove a subnet from network 'servers', use the commands:

```
awplus# configure terminal
awplus(config)# zone dmz
awplus(config-zone)# network servers
awplus(config-network)# no ipv6 subnet 2001:db8::/32
```

Related commands [network \(zone\)](#)
[show entity](#)

network (zone)

Overview Use this command to add a network to a zone entity or configure an existing network.

A network is a high level abstraction of a logical network in a zone. This consists of the IP subnets and interfaces over which it is reachable. Subnets are grouped into networks to apply a common set of rules among the subnets.

Use the **no** variant of this command to destroy a network entity.

Syntax `network <network-name>`
`no network <network-name>`

Parameter	Description
<code><network-name></code>	Network name. You can use all alphanumeric ASCII characters, and the dash (-) and underscore (_) characters. The name can be 1 to 64 characters in long.

Mode Zone Mode

Usage notes A network is a member of a zone. You can create multiple networks in a zone. A network entity is identified with its parent zone using the dot notation, for example, `ZoneName.NetworkName`.

This commands allows you to enter the Network Mode with the prompt **awplus(config-network)#**. In the Network Mode, you can:

- Configure subnets and interfaces for the network entity
- Create and delete host entities in the network

A network must have at least one valid network address for it to result in functioning rules using that network entity. For more information about how to add network address, see the [ip subnet](#) command and the [ipv6 subnet](#) command.

Note that if the network entity is destroyed, the subnets and hosts in the network entity will be destroyed as well.

Example To create a network entity named `servers`, use the commands:

```
awplus# configure terminal
awplus(config)# zone dmz
awplus(config-zone)# network servers
awplus(config-network)#
```

To destroy a network entity named `servers`, use the commands:

```
awplus# configure terminal
awplus(config)# zone dmz
awplus(config-zone)# no network servers
```

**Validation
commands** `show entity`

**Related
commands** `host (network)`
`ip subnet`
`ipv6 subnet`
`zone`

protocol

Overview Use this command to specify a protocol used by an application.

Protocol numbers are used to configure firewalls, routers, and proxy servers. The protocol number is in the protocol field of the IPv4 header and the next header field of IPv6 header. For the full list of the IP Protocol assignments, you can visit the Internet Assigned Numbers Authority (IANA) website at www.iana.org.

Use the **no** variant of this command to unset the protocol in an application.

Syntax `protocol {tcp|udp|icmp|ipv6-icmp|<protocol-number>}`
`no protocol`

Parameter	Description
tcp	Transmission Control Protocol. The protocol number is 6.
udp	User Datagram Protocol. The protocol number is 17.
icmp	Internet Control Message Protocol for Internet Protocol version 4. The protocol number is 1.
ipv6-icmp	Internet Control Message Protocol for Internet Protocol version 6. The protocol number is 58.
<protocol-number>	Protocol number in the range of 0 to 255.

Mode Application Mode

Usage notes You can specify only one protocol for an application. The newly specified protocol will replace the previous one.

Examples To specify protocol `udp` for the application named `isakmp`, use the commands:

```
awplus# configure terminal
awplus(config)# application isakmp
awplus(config-application)# protocol udp
```

To unset the protocol in the application named `isakmp`, use the commands:

```
awplus# configure terminal
awplus(config)# application isakmp
awplus(config-application)# no protocol
```

Related commands [application](#)
[show application](#)

show application

Overview Use this command to show the custom and predefined applications currently configured.

You can use the [show application detail](#) command to show detailed information of the applications.

Syntax `show application`

Mode Privileged Exec

Examples To show all applications currently configured, use the command:

```
awplus# show application
```

Output Figure 65-3: Example output from **show application**

```
awplus#show application
aim          cvs          dns          ftp
http        https       icq          ident
imap        imaps       irc          jabber
l2tp        ldap        lisa        msn
mysql       news        nfs-tcp     nfs-udp
ntp         openvpn     pcanywhere  udp
...
```

Related commands [show application detail](#)

show application detail

Overview Use this command to show detailed information about applications that the device is aware of. For custom and predefined applications, the protocol, destination port, source port, ICMP code, ICMP type, DSCP and the name of the applications will be displayed.

For applications defined by DPI, a description of the application is displayed.

Syntax `show application detail [<name>|custom|dpi]`

Parameter	Description
<name>	The name of a specific application.
custom	User-defined application.
dpi	DPI applications. For DPI applications to be displayed by this command, you must first enable DPI by using the enable (dpi) command and the provider (dpi) command.

Mode Privileged Exec

Examples To show the information about all applications, use the command:

```
awplus# show application detail
```

Output To show the information about the application ping, use the command:

```
awplus# show application detail ping
```

Figure 65-4: Example output from **show application detail** for an application

```
awplus#show application detail ping
Name           Mark    Detail
-----
ping           -       proto=ICMP type=8 code=0
```

Figure 65-5: Example output from **show application detail** with provider **built-in**

```
area3[1]#show application detail
Name           Mark      Detail
-----
afp             0x6A     DPI: Apple Filing Protocol, formerly AppleTalk
              (Cat=File transfer)
aim            -        proto=TCP sport=1024-65535 dport=9898
aimini         0x6C     DPI: Aimini P2P real-time communicatings
              (Cat=Messaging)
ajp            0x94     DPI: Apache JServ Protocol (Cat=Networking)
amazon         0xBB     DPI: Amazon online shopping (Cat=Web Services)
amazonvideo    0xF9     DPI: Amazon on-demand video streaming service
              (Cat=Streaming Media)
amqp           0xC9     DPI: Advanced Message Queuing Protocol
              (Cat=Networking)
apple          0x95     DPI: Apple Inc website (Cat=Networking)
appleicloud    0x98     DPI: A cloud storage and cloud computing service from
              Apple Inc (Cat=File transfer)
appleitunes    0x9A     DPI: A media streaming, broadcasting, and device
              management application from Apple Inc
              (Cat=Streaming Media)
applejuice     0x21     DPI: A defunct file sharing protocol (Cat=File
              transfer)
...

```

Table 65-2: Parameters in the output from **show application detail**

Parameter	Description
Name	Application name—the short name used when referenced from application-aware features (for instance firewall).
Mark	Application mark—the hexadecimal DPI application index representing each protocol or application. This value appears in Firewall log messages, indicating which application the packet or flow was identified as by DPI.
Detail	For custom and pre-defined applications—the IP protocol and port numbers associated with the application. For DPI applications— a longer description of the application.
Cat	Category—a general and high-level category for the application.

Related commands [show application](#)

Command changes Version 5.4.7-2.1: More detail added to the output for DPI commands.
Version 5.4.9-1.1: Category added to output for built-in provider

show entity

Overview Use this command to show entity information.

Entity is a high level abstraction of a network device, a group of networks or subnets. It is the instance that firewall policy can be applied to. There are three types of entity:

- zone
- network
- host

Syntax `show entity [<entity>]`

Parameter	Description
<entity>	Specific entity in dot notation.

Mode Privileged Exec

Examples To show the information about all entities, use the command:

```
awplus# show entity
```

Output Figure 65-6: Example output from the **show entity** command

```
awplus#show entity
Zone:      zone1
Network:   zone1.network1
Subnet:    1:db8:24:100::/64
Subnet:    2001:db8:24:100::/64
Host:      zone1.network1.host1
Address:   2001:db8:24:100::1

Zone:      zone2
Network:   zone2.network2
Host:      zone2.network2.host1
```

To show information associated with the network entity `zone1.network1`, use the command:

```
awplus# show entity zone1.network1
```

Output Figure 65-7: Example output from the **show entity** command

```
awplus#show entity zone1.network1
Network:    zone1.network1
Subnet:     1:db8:24:100::/64
Subnet:     2001:db8:24:100::/64
Host:       zone1.network1.host1
Address:    2001:db8:24:100::1
```

To show information associated with the host entity `zone1.network1.host1`, use the command:

```
awplus# show entity zone1.network1.host1
```

Output Figure 65-8: Example output from the **show entity** command

```
awplus#show entity zone1.network1.host1
Host:      zone1.network1.host1
Address:   192.168.1.5
```

When the entity is using dynamic interface addresses, this will be shown in the output:

Output Figure 65-9: Example output from the **show entity** command

```
awplus#show entity Public
Zone:      Public
Network:   Public.Router
Subnet:    0.0.0.0/0 via ppp0
Host:      Public.Router.ppp0
Address:   10.0.6.1 (dynamic)
```

When the entity is using dynamic FQDN addresses, this will be shown in the output:

Output Figure 65-10: Example output from the **show entity** command using dynamic FQDN addresses on the console

```
awplus#show entity Public
Zone:      Public
Network:   Public.FQDNs
Subnet:    0.0.0.0/0
Subnet:    ::/0
Host:      Public.FQDNs.alliedtelesis
FQDN IPv4: alliedtelesis.com
FQDN IPv6: alliedtelesis.com
Address:   54.66.120.42 (dynamic)
```

```
Host:      Public.FQDNs.facebook
FQDN IPv4: facebook.com
FQDN IPv6: facebook.com
Address:   157.240.8.35 (dynamic)
Address:   2a03:2880:f119:8083:face:b00c:0:25de (dynamic)
Host:      Public.FQDNs.google
FQDN IPv4: google.com
FQDN IPv6: google.com
Address:   216.58.196.142 (dynamic)
Address:   2404:6800:4006:809::200e (dynamic)
Host:      Public.FQDNs.microsoft
FQDN IPv4: microsoft.com
FQDN IPv6: microsoft.com
Address:   23.96.52.53 (dynamic)
Address:   23.100.122.175 (dynamic)
Address:   104.40.211.35 (dynamic)
Address:   104.43.195.251 (dynamic)
Address:   191.239.213.197 (dynamic)
```

Command changes Version 5.4.8-1.1: added output for dynamic interface and FQDN addresses.

sport

Overview Use this command to specify a source port or a port range used for an application.

A port number is part of the addressing information used to identify a specific process to which a network message is to be forwarded between a sender and a receiver. For the full list of port numbers and their assignment, you can visit the Internet Assigned Numbers Authority (IANA) Web site: www.iana.org.

Use the **no** variant of this command to delete ports or port ranges from an application.

NOTE:

The port or port range that you want to delete must match exactly the existing port or port range. You cannot remove a port range that is part of an existing port range.

Syntax `sport {<source-port>|any|<start-range> to <end-range>}`
`no sport {<source-port>|any|<start-range> to <end-range>}`

Parameter	Description
<code><source-port></code>	The source port number, either TCP or UDP, specified as an integer between 1 and 65535.
<code>any</code>	Any port number in the range <code><1-65535></code> . This equals to a range of 1 to 65535.
<code><start-range></code>	Starting port number in the range <code><1-65535></code> .
<code>to</code> <code><end-range></code>	Ending port number in the range <code><1-65535></code> or max.

Mode Application Mode

Usage notes You can have up to 15 **sports** per application. This is counted as follows:

- a single **sport** counts as 1 port
- a range counts as 2 ports
- the keyword **any** counts as 2 ports.

Examples To specify source port 500 for the application named isakmp, use the commands:

```
awplus# configure terminal
awplus(config)# application isakmp
awplus(config-application)# sport 500
```

To specify source port 500 and a range of ports for the application named isakmp, use the commands:

```
awplus# configure terminal
awplus(config)# application isakmp
awplus(config-application)# sport 500
awplus(config-application)# sport 60000 to max
```

To specify the source port **any** (a port number range of 1-65535) for the application named isakmp, use the commands:

```
awplus# configure terminal
awplus(config)# application isakmp
awplus(config-application)# sport any
```

To remove source port 500 from the application named isakmp, use the commands:

```
awplus# configure terminal
awplus(config)# application isakmp
awplus(config-application)# no sport 500
```

To remove all source ports from the application named isakmp, use the commands:

```
awplus# configure terminal
awplus(config)# application isakmp
awplus(config-application)# no sport 1 to 65535
```

**Related
commands**

[application](#)
[dport](#)
[show application](#)

zone

Overview Use this command to create a zone entity or configure an existing zone.

Zone is a high level abstraction for a logical grouping or segmentation of physical networks. This is the highest level of partitioning that firewall policy can be applied to. Zone establishes the security border of your networks. A zone defines a boundary where traffic is subjected to policy restrictions as it crosses to another region of your networks. The minimum zones normally implemented would be a trusted zone for the private network behind the firewall and a untrusted zone for the Internet. Other common zones are a Demilitarized Zone (DMZ) for publicly visible web servers and a Virtual Private Network (VPN) zone for remote access users or tunnels to other networks.

Use the **no** variant of this command to destroy a zone entity.

Syntax `zone <zone-name>`
`no zone <zone-name>`

Parameter	Description
<code><zone-name></code>	Zone name. You can use all alphanumeric ASCII characters, and the dash (-) and underscore (_) characters. The name can be 1 to 64 characters long.

Mode Global Configuration

Usage notes This command allows you to enter the Zone Mode with the prompt **awplus(config-category)#**. The Zone Mode enables you to create, configure and delete network entities. For more information about network entity, see the [network \(zone\)](#) command.

A zone entity must have at least one network entity for it to result in functioning rules using that zone entity. For more information about how to add network entities, see the [network \(zone\)](#) command.

Note that if the zone entity is destroyed, the networks and hosts of this zone will be destroyed as well.

Examples To create a zone named `private`, use the commands:

```
awplus# configure terminal
awplus(config)# zone private
awplus(config-zone)#
```

To destroy zone `private` and all its networks, subnets and hosts, use the commands:

```
awplus# configure terminal
awplus(config)# no zone private
```

Validation show entity
commands

66

NAT Commands

Introduction

Overview This chapter provides an alphabetical reference of commands used to configure Network Address Translation (NAT). For more information about NAT introduction and configuration example, see the [Firewall_and Network Address Translation \(NAT\) Feature Overview and Configuration_Guide](#).

The following figure lists the NAT commands and their applicable modes.

Figure 66-1: NAT commands and applicable modes

Mode	Command
Privileged Exec	<code>show nat</code>
	<code>show nat rule</code>
	<code>show nat rule config-check</code>
	<code>show running-config nat</code>
Global Configuration	<code>nat</code>
NAT Configuration	<code>enable (nat)</code>
	<code>move rule (nat)</code>
	<code>rule (nat)</code>

- Command List**
- [“enable \(nat\)”](#) on page 3530
 - [“ip limited-local-proxy-arp”](#) on page 3531
 - [“local-proxy-arp”](#) on page 3533
 - [“move rule \(nat\)”](#) on page 3534
 - [“nat”](#) on page 3535
 - [“rule \(nat\)”](#) on page 3536

- [“show nat”](#) on page 3540
- [“show nat rule”](#) on page 3541
- [“show nat rule config-check”](#) on page 3543
- [“show running-config nat”](#) on page 3544

enable (nat)

Overview Use this command to enable NAT .

Use the **no** variant of this command to disable NAT without losing existing NAT configuration.

Syntax enable
no enable

Default NAT is disabled by default.

Mode NAT Configuration

Examples To enable NAT, use the commands:

```
awplus# configure terminal
awplus(config)# nat
awplus(config-nat)# enable
```

To disable NAT, use the commands:

```
awplus# configure terminal
awplus(config)# nat
awplus(config-nat)# no enable
```

Validation commands show nat
show running-config nat

ip limited-local-proxy-arp

Overview Use this command to enable local proxy ARP, but only for a specified set of IP addresses. This makes the device respond to ARP requests for those IP addresses when the addresses are reachable via the interface you are configuring.

To specify the IP addresses, use the command [local-proxy-arp](#).

Use the **no** variant of this command to disable limited local proxy ARP. This stops your device from intercepting and responding to ARP requests for the specified hosts. This allows the hosts to use MAC address resolution to communicate directly with one another.

Syntax `ip limited-local-proxy-arp`
`no ip limited-local-proxy-arp`

Default Limited local proxy ARP is disabled by default.

Mode Interface Configuration for VLAN, Eth, WWAN, L2TP tunnel, Multipoint VPN GRE, and bridge interfaces and 802.1Q sub-interfaces.

Usage Limited local proxy ARP supports Static NAT configurations in which the NAT configuration's public address is different to the Ethernet interface's address.

On such Ethernet interfaces, the device needs to respond to ARP requests for the public address so that it will receive packets targeted at that address.

Limited local proxy ARP makes this possible. It is especially useful when you have a number of 1-1 NAT configurations and each public address falls within the public interface's subnet. If you enable limited local proxy ARP on the public interface and specify suitable addresses, the device will respond to ARP requests for those addresses, as long as the addresses are routed out the interface the ARP requests are received on. The device responds with its own MAC address.

Example The following configuration snippet shows how to use limited local proxy ARP, if you are using NAT for an HTTP server with an address of 172.22.0.3 connected via eth1, and eth1 has an address of 172.22.0.1:

```
! Create a private zone for the HTTP server with address 172.22.200.3:
zone private
network vlan1
ip subnet 172.22.200.0/24
host http_server
ip address 172.22.200.3
!
! Create a public zone for the HTTP server with address 172.22.0.3:
zone public
network eth1
ip subnet 0.0.0.0/0 interface eth1
host http_server
ip address 172.22.0.3
!
! Create a NAT rule to map from the public to the private zone:
nat
rule 10 portfwd http from public.eth1 to public.eth1.http_server with dst
private.vlan1.http_server
enable
!
! Configure eth1. It has a different public address than the HTTP server:
interface eth1
ip limited local-proxy-arp
ip address 172.22.0.1/24
!
! Configure vlan1:
interface vlan1
ip address 172.22.200.5/24
!
! Tell the device to respond to ARPs for the HTTP server public address:
local-proxy-arp 172.22.0.3/32
```

Related commands [ip local-proxy-arp](#)
[local-proxy-arp](#)

local-proxy-arp

Overview Use this command to specify an IP subnet for use with limited local proxy ARP. When limited local proxy ARP is enabled with the command [ip limited-local-proxy-arp](#), the device will respond to ARP requests for addresses in that subnet.

Use the **no** variant of this command to stop specifying a subnet for use with limited local proxy ARP.

Syntax `local-proxy-arp [<ip-add/mask>]`
`no local-proxy-arp [<ip-add/mask>]`

Parameter	Description
<code><ip-add/mask></code>	The IP subnet to use with limited local proxy ARP, in dotted decimal format (A.B.C.D/M). To specify a single IP address, use a 32-bit mask.

Default No subnets are specified for use with limited local proxy ARP.

Mode Global Configuration

Example To specify limited local proxy ARP for the address 172.22.0.3, use the following commands:

```
awplus# configure terminal
awplus(config)# local-proxy-arp 172.22.0.3/32
```

This is part of a configuration snippet that shows how to use limited local proxy ARP with static NAT. See the command [ip limited-local-proxy-arp](#) for the whole example.

Related commands [ip limited-local-proxy-arp](#)

move rule (nat)

Overview Use this command to change the order of a NAT rule.

You can move an existing rule ID only to an ID that is not assigned to any rule, otherwise you will receive an error message.

Syntax `move rule <1-65535> to <1-65535>`

Parameter	Description
<code>move rule <1-65535></code>	Move the order of a given rule. The rule ID of the given rule must exist. Each rule has an ID which is either designated by the user or automatically generated when the rule is created. The rule ID is an integer from 1 to 65535.
<code>to <1-65535></code>	New rule ID to assign. The new rule ID must not be used by any existing rule.

Mode NAT Configuration

Examples To change the ID of a rule from 10 to 30, use the commands:

```
awplus# configure terminal
awplus(config)# nat
awplus(config-nat)# move rule 10 to 30
```

Validation commands `show nat rule`
`show running-config nat`

Related commands `rule (nat)`

nat

Overview Use this command to configure NAT.

Use the **no** variant of this command to remove all NAT configuration.

Syntax nat
no nat

Mode Global Configuration

Usage notes This command allows you to enter the NAT Configuration mode. The command prompt for this mode is **awplus(config-nat)#**.

In the NAT Configuration mode, you can:

- Enable NAT, see the [enable \(nat\)](#) command.
- Create NAT rules or change the order of NAT rules, see the [rule \(nat\)](#) command and the [move rule \(nat\)](#) command.

Examples To configure NAT, use the commands:

```
awplus# configure terminal
awplus(config)# nat
awplus(config-nat)#
```

To remove all NAT configuration, use the commands:

```
awplus# configure terminal
awplus(config)# no nat
```

Validation commands [show nat](#)

rule (nat)

Overview Use this command to create a NAT rule.

Use the **no** variant of this command to remove a specified rule or all rules.

Syntax

```
rule [<1-65535>] masq <application-name> from <source-entity>  
to <destination-entity> [with src <source-host-entity>]  
  
rule [<1-65535>] portfw <application-name> from <source-entity>  
[to <destination-entity>] with dst <destination-host-entity>  
[dport <1-65535>]  
  
rule [<1-65535>] netmap <application-name> from  
<source-subnet-entity> to <destination-subnet-entity> with  
{src|dst} <translated-subnet-entity>  
  
no rule {<1-65535>|all}
```

Parameter	Description
<1-65535>	Rule ID is an integer in the range 1 to 65535. If you do not designate a rule ID, a rule ID will be automatically generated and it will be greater than the current highest rule ID.
masq	The type of NAT rule. NAT with IP Masquerade is a case where all or a range of addresses are mapped to a single address with source port translation to identify the association. This single address masquerades as the public source address for the private addresses.
portfw	The type of NAT rule. Port forwarding allows remote hosts to connect to a specific host or service within a private LAN. This will forward IPv4 packets on to another device, for example, forward HTTP traffic to an internal web server.
netmap	The type of NAT rule. Use subnet-based NAT to translate the subnet portion of IP addresses while leaving the host portion unchanged.
<application-name>	In all NAT rules, the application name, either one of the predefined applications or an application defined by using the application command. You can use the tab key to auto-complete application names.

Parameter	Description
<code><source-entity></code>	<p>Source entity name. An entity represents a logical grouping of subnets, hosts or interfaces, created by the zone, network (Entity), or host (Entity) commands. You can use the tab key to auto-complete entity names.</p> <p>In a masq rule, the source entity defines the private side of the router. You assign private IP addresses (RFC 1918) to hosts on the private side of the router. When those hosts send traffic, the router translates the private addresses to one or more publicly valid addresses before routing the traffic. When the router receives traffic that is destined for those hosts, it translates the public addresses back to the appropriate private addresses.</p> <p>In a portfw rule, the source entity may be an entity outside your private network.</p>
<code><destination-entity></code>	<p>The destination entity name. The destination entity defines the pool of public-valid IP addresses. It can be a zone (created by the zone command), network (network (Entity) command) or host (host (Entity) command).</p>
<code><source-host-entity></code>	<p>In a masq rule, the specific source host address that the traffic will masquerade as. The source -host-entity must be a host with one IP address, created by using the host (Entity) command.</p>
<code><destination-host-entity></code>	<p>In a portfw rule, the target entity name of the specific destination host that the traffic will be port-forwarded to. The target entity must be a host with one IP address, created by using the host (Entity) command.</p>
<code>dport <1-65535></code>	<p>In a portfw rule, modify the destination port to the specified port. (Only for protocols that have ports.)</p>
<code><source-subnet-entity></code>	<p>The source entity that the netmap rule will apply to, for instance a network created by the network (Entity) command. When the with src parameter is used, this source-subnet-entity is translated to the <code><translated-subnet-entity></code> specified.</p>
<code><destination-subnet-entity></code>	<p>The destination entity that the netmap rule applies to, for instance a network created by the network (Entity) command. When the with dst parameter is used, this destination subnet is translated to the <code><translated-subnet-entity></code> specified.</p>

Parameter	Description
<code><translated-subnet-entity></code>	In a netmap rule: with src: Modify the source-subnet-entity to the specified translated-subnet-entity, for instance a network created by the network (Entity) command. Both network entities must contain one subnet with a matching subnet mask. with dst: Modify the destination-subnet-entity to the specified translated-subnet-entity, for instance a network created by the network (Entity) command. Both network entities must contain one subnet with a matching subnet mask.
<code>all</code>	Remove all rules.

Mode NAT Configuration

Usage notes You can change the rule order by using the [move rule \(nat\)](#) command.

Firewall is used in conjunction with NAT. Port forwarding (**portfw**) and masquerade (**masq**) rules do not implicitly permit packets. **Portfw** rules (actions) are applied before any other firewall and **masq** rules (actions) are applied after any other firewall rules. When firewall protection is enabled, all traffic is blocked by default. Use the [rule \(firewall\)](#) command to configure firewall rules which allow the same application, source and destination entities you configure for the NAT rules.

Netmap **dst** rules are applied to traffic before it reaches the firewall rules, and netmap **src** rules are applied after the firewall has permitted the traffic. Firewall rules must be written to permit the traffic after it has been translated by the netmap **dst** rules.

Entities should have valid interfaces on which inbound and outbound traffic can be properly translated. You can use the [ip subnet](#) command and the [ipv6 subnet](#) command to configure the interfaces.

Removing a NAT rule for an actively translated flow does not stop it translating immediately. This means subsequent packets in the flow continue to be translated.

The continued translation after the associated NAT rule is removed will only stop when:

- The [clear firewall connections](#) command is executed or the flow stops.
- One of the following actions occurs:
 - You can use the [clear firewall connections](#) command to manually stop translations immediately, when the associated rule has been deleted regardless whether the firewall feature is actually configured with NAT or not.
 - The NAT rule is cleared when the traffic flow ends naturally, for example, stopped from the source. If the flow is re-initiated from a host, it will not be translated by the firewall, as the rule is deleted after the first flow stopped.

Examples To perform network address translation and port forward application 'http' from entity 'public' to any with target destination dmz.servers.web_server, use the commands:

```
awplus# configure terminal
awplus(config)# nat
awplus(config-nat)# rule 10 portfw
http from public with dst dmz.servers.web_server
```

To perform network address translation and masquerade application 'http' from entity 'private' to 'public', use the commands:

```
awplus# configure terminal
awplus(config)# nat
awplus(config-nat)# rule 20 masq
http from private to public
```

To use subnet-based NAT to translate the source address of all traffic from 'private.lan' going to 'remote.lan' with the new subnet specified in 'private.global', use the commands:

```
awplus# configure terminal
awplus(config)# nat
awplus(config-nat)# rule 30 netmap all from private.lan to
remote.lan with src private.global
```

To remove NAT rule 10, use the command:

```
awplus(config-nat)# no rule 10
```

**Related
commands**

[application](#)
[clear firewall connections](#)
[host \(network\)](#)
[move rule \(nat\)](#)
[nat](#)
[network \(zone\)](#)
[show nat rule](#)
[show nat rule config-check](#)
[show running-config nat](#)
[zone](#)

**Command
changes** Version 5.4.7-0.1: **netmap** option added.

show nat

Overview Use this command to show the configuration state of NAT.

Syntax show nat

Mode Privileged Exec

Examples To show the configuration state of NAT, use the commands:

```
awplus# show nat
```

Output Figure 66-2: Example output from the **show nat** command

```
awplus#show nat
NAT is enabled
```

Related commands [enable \(nat\)](#)

show nat rule

Overview Use this command to show information about NAT rules.

Syntax show nat rule [*<1-65535>*]

Parameter	Description
<i><1-65535></i>	Rule ID

Mode Privileged Exec

Examples To show information about all NAT rules, use the command:

```
awplus# show nat rule
```

Output Figure 66-3: Example output from the **show nat rule** command

```
awplus#show nat rule

[* = Rule is not valid - see "show nat rule config-check"]
  ID      Action  App      From      To      With      Hits
-----
* 30     masq    any      private   public   -         0
  10     portfw  http     public    -        dmz.a.b   0
```

To show information about a specific NAT rule, use the command:

```
awplus# show nat rule 10
```

Output Figure 66-4: Example output from the **show nat rule** command

```
awplus#show nat rule 10

[* = Rule is not valid - see "show nat rule config-check"]
  ID      Action  App      From      To      With      Hits
-----
  10     portfw  http     public    -        dmz.a.b   0
```

Output Parameter	Description
*	Indicates the rule is not valid and cannot be hit, see the show nat rule config-check command.
App	Application name.
From	Source entity.

Output Parameter	Description
with	Target entity name.
To	Destination entity.
Hits	The number of times the NAT rule has been hit.

Related commands [rule \(nat\)](#)
[show nat rule config-check](#)

show nat rule config-check

Overview Use this command to check configuration validity of NAT rules.

An invalid rule will not be active and cannot be hit.

This command also shows the reasons why a rule is not valid.

Syntax `show nat rule config-check`

Mode Privileged Exec

Usage notes NAT rules are applied to applications and entities. A rule is not valid if either the application, source entity or destination entity the rule applies to is not configured properly.

To configure applications and entities, see Application and Entity Commands.

Examples To check configuration validity of NAT rules, use the command:

```
awplus# show nat rule config-check
```

Output Figure 66-5: Example output from the **show nat rule config-check** command if rule configuration errors are detected

```
awplus#show nat rule config-check
Rule 10:
  Application does not have a protocol configured
  "From" entity does not exist
  "To" entity has no subnet or host addresses
```

Output Figure 66-6: Example output from the **show nat rule config-check** command if all rules are valid

```
awplus#show nat rule config-check
All rules are valid
```

show running-config nat

Overview Use this command to show the configuration commands that have been used to configure NAT.

Syntax `show running-config nat`

Mode Privileged Exec

Examples To show the configuration commands that have been used to configure NAT, use the commands:

```
awplus# show running-config nat
```

Output Figure 66-7: Example output from the **show running-config nat** command

```
awplus#show running-config nat
nat
 rule 10 masq http from private to public
 rule 20 portfw http from public with dst dmz.servers.wb
 enable
!
```

Part 9: Advanced Network Protection

67

IPS Commands

Introduction

Overview This chapter provides an alphabetical reference of commands used to configure Intrusion Prevention System (IPS). For more information, see the [IPS Feature Overview and Configuration_Guide](#).

The table below lists the IPS commands and their applicable modes.

Figure 67-1: IPS Commands and Applicable Modes

Mode	Command
Privileged Exec	<code>show ips</code>
	<code>show ips categories</code>
	<code>show running-config ips</code>
Global Configuration	<code>ips</code>
IPS Mode	<code>alert-thresholding</code>
	<code>category action (IPS)</code>
	<code>protect (IPS)</code>

- Command List**
- [“alert-thresholding”](#) on page 3547
 - [“category action \(IPS\)”](#) on page 3548
 - [“ips”](#) on page 3549
 - [“protect \(IPS\)”](#) on page 3550
 - [“show ips”](#) on page 3551
 - [“show ips categories”](#) on page 3552
 - [“show running-config ips”](#) on page 3554

alert-thresholding

Overview Use this command to limit IPS to a maximum of 6 alerts per minute per destination IP address. This prevents IPS alerts from overwhelming the log files.

Use the **no** variant of this command to turn off the limit if you need to log every packet that matches an IPS rule (for example, for debugging purposes).

Syntax alert-thresholding
no alert-thresholding

Default Enabled

Mode IPS Configuration

Example To stop limiting the number of IPS alerts, so that the device logs every packet that matches an IPS rule, use the commands:

```
awplus# configure terminal
awplus(config)# ips
awplus(config-ips)# no alert-thresholding
```

To limit the number of IPS alerts again, use the commands:

```
awplus# configure terminal
awplus(config)# ips
awplus(config-ips)# alert-thresholding
```

Related commands show log
show ips

Command changes Version 5.5.0-2.1: command added

category action (IPS)

Overview Use this command to configure an action for a specified category.
Use the **no** variant of this command to set the default action of alert for a specified category.

Syntax `category <category-name> action {alert|deny|disable}`
`no category <category-name> action`

Parameter	Description
<code><category-name></code>	Category name. A category is a label that helps to classify the nature of traffic, for example, whether it is spammer, spot or spyware and so on. Once IPS protection is enabled, traffic will be categorized according to the available IPS categories. You can use the show ips categories command to view the categories and their actions.
<code>alert</code>	Generate a log message. This is the default action.
<code>deny</code>	Drop the matching packets. No error message is sent back to the source host.
<code>disable</code>	Ignore a specified category. Ignored categories will not be used to categorize traffic.

Default The default action is alert.

Mode IPS Mode

Examples To drop packet categorized as `checksum`, use the commands:

```
awplus# configure terminal
awplus(config)# ips
awplus(config-ips)# category checksum action deny
```

To set the default action for category `checksum`, use the commands:

```
awplus# configure terminal
awplus(config)# ips
awplus(config-ips)# no category checksum action
```

Validation Commands [show ips categories](#)
[show running-config ips](#)

ips

Overview Use this command to configure IPS.

Use the **no** variant of this command to remove all IPS configuration.

Syntax `ips`
`no ips`

Mode Global Configuration

Usage notes This command allows you to enter the IPS mode. The command prompt for this mode is **awplus(config-ips)#**.

In the IPS mode, you can:

- Enable or disable IPS protection, see the [protect \(IPS\)](#) command.
- Configure an action for specified categories, see the [category action \(IPS\)](#) command.

Examples To configure IPS, use the commands:

```
awplus# configure terminal
awplus(config)# ips
awplus(config-ips)#
```

To remove all IPS configuration, use the commands:

```
awplus# configure terminal
awplus(config)# no ips
```

protect (IPS)

Overview Use this command to enable IPS protection .
Use the **no** variant of this command to disable IPS protection.

Syntax protect
no protect

Usage notes Once IPS protection is enabled, traffic will be categorized according to the available IPS categories. See the [show ips categories](#) command for the list of available IPS categories.

Default IPS is disabled by default.

Mode IPS Mode

Examples To enable IPS protection, use the commands:

```
awplus# configure terminal
awplus(config)# ips
awplus(config-ips)# protect
```

To disable IPS protection, use the commands:

```
awplus# configure terminal
awplus(config)# ips
awplus(config-ips)# no protect
```

Validation Commands [show ips](#)
[show running-config ips](#)

show ips

Overview Use this command to show the IPS configuration state and event count for the Intrusion Prevention System (IPS).

Syntax `show ips`

Mode Privileged Exec

Examples To display information about IPS, use the command:

```
awplus# show ips
```

Output Figure 67-2: Example output from **show ips**

```
awplus#show ips
Status:           Enabled (Active)
Events:           4
Alert Thresholding: Enabled
```

Table 67-1: Parameters in the output from **show ips**

Parameter	Description
Alert Thresholding	Either Enabled or Disabled. When enabled, IPS produces a maximum of 6 alerts per minute per destination IP address. This prevents IPS alerts from overwhelming the log files. To enable or disable this, use the alert-thresholding command.

show ips categories

Overview Use this command to show the IPS categories and their actions.

Note that if the IPS database provider is configured, this commands shows only the provider's categories.

Syntax `show ips categories`

Mode Privileged Exec

Examples To show the IPS categories and their actions, use the command:

```
awplus# show ips categories
```

Output Figure 67-3: Example output of built-in categories from the **show ips categories** command

```
awplus#show ips categories
Category (* = invalid)      Action
-----
checksum                    alert
ftp-bounce                  alert
gre-decoder-events         alert
http-events                 alert
icmp-decoder-events        alert
ip-decoder-events          alert
ppp-decoder-events         alert
smtp-events                alert
stream-events              alert
udp-decoder-events         alert
```

Parameter	Description
checksum	Invalid checksums, e.g. IPv4, TCPv4, UDPv4, ICMPv4, TCPv6, UDPv6, ICMPv6.
ftp-bounce	GPL FTP PORT bounce attempt.
gre-decoder events	GRE anomalies, e.g. GRE packet too small, GRE wrong version, GRE v0 recursion control, GRE v0 flags, GRE v0 header too big, GRE v1 checksum present, GRE v1 routing present, GRE v1 strict source route, GRE v1 recursion control.
http-events	HTTP anomalies, e.g. HTTP unknown error, HTTP gzip decompression failed, HTTP request field missing colon, HTTP response field missing colon, HTTP invalid request chunk len, HTTP invalid response chunk len, HTTP status 100-Continue already seen, HTTP unable to match response to request, HTTP invalid server port in request.

Parameter	Description
icmp-decoder-events	ICMP anomalies, e.g. IPv6 with ICMPv4 header, ICMPv4 packet too small, ICMPv4 unknown type, ICMPv6 truncated packet, ICMPv6 unknown version.
ip-decoder-events	IPv4 & IPv6 anomalies, e.g. IPv4 packet too small, IPv4 header size too small, IPv4 wrong IP version, IPv6 packet too small, IPv6 duplicated Routing extension header, IPv6 duplicated Hop-By-Hop Options extension header, IPv6 DSTOPTS only padding, SLL packet too small, Ethernet packet too small, VLAN header too small, FRAG IPv4 Fragmentation overlap, FRAG IPv6 Packet size too large, IPv4-in-IPv6 invalid protocol, IPv6-in-IPv6 packet too short.
ppp-decoder-events	PPP anomalies, e.g. PPP packet too small, PPP IPv6 too small, PPP wrong type, PPPoE wrong code, PPPoE malformed tags.
smtp-events	SMTP anomalies, e.g. SMTP invalid reply, SMTP max reply line len exceeded, SMTP tls rejected, SMTP data command rejected.
stream-events	TCP anomalies, e.g. 3way handshake with ack in wrong dir, 3way handshake async wrong sequence, 3way handshake right seq wrong ack evasion, 4way handshake SYNACK with wrong ACK, STREAM CLOSEWAIT FIN out of window, STREAM ESTABLISHED SYNACK resend, STREAM FIN invalid ack, STREAM FIN1 ack with wrong seq, STREAM TIMEWAIT ACK with wrong seq, stream-events TCP packet too small, stream-events TCP duplicated option)
udp-decoder-events	UDP anomalies, e.g. UDP packet too small, UDP header length too small, UDP invalid header length

show running-config ips

Overview Use this command to show the configuration commands that have been used to configure IPS.

Syntax `show running-config ips`

Mode Privileged Exec

Examples To show the commands that have been used to configure IPS, use the command:

```
awplus# show running-config ips
```

Output Figure 67-4: Example output from the **show running-config ips** command

```
awplus#show running-config ips
ips
  protect
!
```

68

URL Filtering Commands

Introduction

Overview This chapter provides an alphabetical reference of commands used to configure URL filtering.

URL filtering blocks all HTTP and HTTPS access to a list of websites. You can specify a short list of websites (up to 1000 blacklist and 1000 whitelist rules) using custom blacklists to block URLs and custom whitelists to allow access to URLs.

For more information, see the [URL Filtering Feature Overview_and Configuration Guide](#).

The following table lists the URL filtering commands and their applicable modes.

Figure 68-1: URL filtering commands and applicable modes

Mode	Command
Privileged Exec	<code>show running-config url-filter</code>
	<code>show url-filter</code>
	<code>url-filter reload custom-lists</code>
Global Configuration	<code>url-filter</code>
URL Filter Configuration	<code>blacklist</code>
	<code>protect (url-filter)</code>
	<code>whitelist (url-filter)</code>

- Command List**
- `"blacklist"` on page 3557
 - `"log url-requests"` on page 3558
 - `"protect (url-filter)"` on page 3559
 - `"show running-config url-filter"` on page 3560
 - `"show url-filter"` on page 3561

- [“url-filter reload custom-lists”](#) on page 3562
- [“url-filter”](#) on page 3563
- [“whitelist \(url-filter\)”](#) on page 3564

blacklist

Overview Use this command to add a custom blacklist file to the URL filtering configuration. Use the **no** variant of this command to remove a blacklist from the URL filtering configuration.

Syntax `blacklist <location_of_blacklist_file>`
`no blacklist <location_of_blacklist_file>`

Parameter	Description
<code><location_of_blacklist_file></code>	Location of the blacklist file. The blacklist file can be located in flash or on a USB device.

Mode URL Filter Configuration

Usage notes You can use custom blacklists to specify URLs to be blocked.

For information about blacklist rule format, see the [URL Filtering Feature Overview and Configuration Guide](#).

You can use the [whitelist \(url-filter\)](#) command to add a whitelist that will override any corresponding blacklist entries.

Examples To add a blacklist that uses a custom file that is stored on a USB device, and then enable URL filtering, use the commands:

```
awplus# configure terminal
awplus(config)# url-filter
awplus(config-url-filter)# blacklist usb:/my_blacklist.txt
awplus(config-url-filter)# protect
```

To remove that blacklist file from the URL filtering configuration, use the commands:

```
awplus# configure terminal
awplus(config)# url-filter
awplus(config-url-filter)# no blacklist usb:/my_blacklist.txt
```

Related commands

- [protect \(url-filter\)](#)
- [show url-filter](#)
- [url-filter reload custom-lists](#)
- [whitelist \(url-filter\)](#)

log url-requests

Overview If URL Filtering is enabled, then by default, black list hits and issues with match criteria and list files are logged.

Use this command to enable logging of all HTTP and HTTPS URL requests (both permitted and denied) passing through the firewall.

Use the **no** variant of this command to disable extra logging of HTTP and HTTPS URL requests passing through the firewall.

Syntax `log url-requests`
`no log url-requests`

Default Disabled by default.

Mode URL Filter Configuration

Usage notes When enabled, additional log messages for HTTP and HTTPS URL requests passing through the firewall contain the:

- URL being accessed
- IP address of the user that requested the URL

Example To configure logging of all HTTP and HTTPS URL requests passing through the firewall (permitted as well as denied), use the following commands:

```
awplus# configure terminal
awplus(config)# url-filter
awplus(config-url-filter)# log url-requests
```

Related commands [url-filter](#)

Command changes Version 5.4.7-1.1: command added

protect (url-filter)

Overview Use this command to enable URL filter protection.
Use the **no** variant of this command to disable URL filter protection without losing the existing URL filter configuration.

Syntax protect
no protect

Default URL filter protection is disabled by default and all HTTP and HTTPS traffic is allowed.

Mode URL Filter Configuration

Examples To enable URL filter protection, use the commands:

```
awplus# configure terminal
awplus(config)# url-filter
awplus(config-url-filter)# protect
```

To disable URL filter protection, use the commands:

```
awplus# configure terminal
awplus(config)# url-filter
awplus(config-url-filter)# no protect
```

Related commands [show url-filter](#)

Command changes Version 5.4.7-1.1: HTTPS support added.

show running-config url-filter

Overview Use this command to show the running configuration information for URL filtering

Syntax `show running-config url-filter`

Mode Privileged Exec

Examples To show the running configuration of URL filtering, use the command:

```
awplus# show running-config url-filter
```

show url-filter

Overview Use this command to show information about the configuration state of URL filtering.

Syntax `show url-filter`

Mode Privileged Exec

Examples To show information about the configuration state of URL filtering, use the command:

```
awplus# show url-filter
```

Output Figure 68-2: Example output from **show url-filter**

```
awplus#show url-filter
Status:      Enabled (Active)
Events:      104
Custom blacklists  Entries
  blacklist-example.txt  365
Custom whitelists  Entries
  whitelist-example.txt  4
```

Command changes Version 5.4.7-0.1: Event count added to the command output.

url-filter reload custom-lists

Overview Use this command to reload all custom blacklists and whitelists after editing one or more of them.

Syntax `url-filter reload custom-lists`

Mode Privileged Exec

Examples To reload all custom blacklists and whitelists, use the following command:

```
awplus# url-filter reload custom-lists
```

Related commands [blacklist](#)
[whitelist \(url-filter\)](#)

url-filter

Overview Use this command to enter URL Filter Configuration mode and configure URL filtering functionality.

Use the **no** variant of this command to remove all URL filtering configuration.

Syntax `url-filter`
`no url-filter`

Mode Global Configuration

Usage notes This command allows you to enter the URL Filter Configuration mode and changes the command prompt to **awplus(config-url-filter)#**.

The URL Filter Configuration mode enables you to:

- Enable URL filtering protection; see the [protect \(url-filter\)](#) command.
- Configure custom blacklists; see the [blacklist](#) command.
- Configure custom whitelists; see the [whitelist \(url-filter\)](#) command.

Examples To enter the URL Filter Configuration mode, use the commands:

```
awplus# configure terminal
awplus(config)# url-filter
awplus(config-url-filter)#
```

To remove all URL filter configuration, use the commands:

```
awplus# configure terminal
awplus(config)# no url-filter
```

Related commands [blacklist](#)
[protect \(url-filter\)](#)
[show running-config](#)
[show url-filter](#)
[whitelist \(url-filter\)](#)

whitelist (url-filter)

Overview Use this command to add a custom whitelist file to the URL filtering configuration. Use the **no** variant of this command to remove a whitelist from the URL filter configuration.

Syntax `whitelist <url_of_whitelist_file>`
`no whitelist <location_of_whitelist_file>`

Parameter	Description
<code><location_of_whitelist_file></code>	Location of the whitelist file. The whitelist file can be located in flash or on a USB device.

Mode URL Filter Configuration

Usage notes Whitelist matching precedes blacklist matching. You can use custom whitelists to override any corresponding blacklist entries. An HTTP or HTTPS request that includes a URL that matches an entry in a whitelist will be permitted.

For information about whitelist rule format, see the [URL Filtering Feature Overview and Configuration Guide](#).

Examples To add a whitelist that uses a custom file that is stored on a USB device, and then enable URL filtering, use the commands:

```
awplus# configure terminal
awplus(config)# url-filter
awplus(config-url-filter)# whitelist usb:/my_whitelist.txt
awplus(config-url-filter)# protect
```

To remove that whitelist file from the URL filtering configuration, use the commands:

```
awplus# configure terminal
awplus(config)# url-filter
awplus(config-url-filter)# no whitelist usb:/my_whitelist.txt
```

Related commands [blacklist](#)
[protect \(url-filter\)](#)
[show url-filter](#)
[url-filter reload custom-lists](#)

Command changes Version 5.4.7-1.1: HTTPS support added.

69

Application Awareness Commands

Introduction

This chapter provides an alphabetical reference of commands used to configure application awareness, which uses Deep Packet Inspection (DPI). For more information about application awareness and a configuration example, see the [Application Awareness Feature Overview and Configuration_Guide](#).

- Command List**
- [“counters detailed”](#) on page 3566
 - [“dpi”](#) on page 3567
 - [“enable \(dpi\)”](#) on page 3568
 - [“hostname \(application\)”](#) on page 3570
 - [“provider \(dpi\)”](#) on page 3571
 - [“show dpi”](#) on page 3572
 - [“show dpi statistics”](#) on page 3573
 - [“show running-config dpi”](#) on page 3575
 - [“web-categorization”](#) on page 3576

counters detailed

Overview Use this command to enable the display of transmit and receive counters for each entity in DPI mode.

Once you have enabled detailed counters, you can use the command **show dpi statistics <entity-name>** to display statistics for different applications on individual entities (zones, networks or hosts). This is called DPI statistics per entity.

Use the **no** variant of this command to disable DPI statistics per entity.

Syntax counters detailed
no counters detailed

Default Disabled

Mode DPI Configuration

Usage notes These counters will require system resources and should only be configured when required. Use the **no** variant to turn them off when not required.

Example To configure DPI statistics per entity, use the commands:

```
awplus# configure terminal
awplus(config)# dpi
awplus(config-dpi)# provider built-in
awplus(config-dpi)# enable
awplus(config-dpi)# counters detailed
```

To disable DPI statistics per entity, use the commands:

```
awplus# configure terminal
awplus(config)# dpi
awplus(config-dpi)# no counters detailed
```

Related commands [show dpi statistics](#)

Command changes Version 5.4.9-1.1: command added

dpi

Overview Use this command to enter DPI Configuration mode to configure DPI for application awareness.

Use the **no** variant of this command to remove all DPI configuration.

Syntax dpi
no dpi

Mode Global Configuration

Usage notes In DPI Configuration mode, you can:

- Set the DPI provider, using the [provider \(dpi\)](#) command.
- Enable DPI, using the [enable \(dpi\)](#) command.

Examples To begin configuring DPI, use the commands:

```
awplus# configure terminal
awplus(config)# dpi
awplus(config-dpi)#
```

To remove all DPI configuration, use the commands:

```
awplus# configure terminal
awplus(config)# no dpi
```

Command changes Version 5.4.7-2.1: command added

enable (dpi)

Overview Use this command to enable DPI for application awareness.

Use the **no** variant of this command to disable DPI without losing existing DPI configuration.

Syntax enable
no enable

Default DPI is disabled by default.

Mode DPI Configuration

Usage notes Use the [provider \(dpi\)](#) command to configure the DPI provider before enabling DPI.

When DPI is enabled, it can classify network traffic and identify today's most common applications.

DPI itself does not control or apply rules to the traffic. You can use the application awareness provided by DPI for:

- Network visibility
- Application Control, using the [rule \(firewall\)](#) command to enforce security policy and apply rules to the DPI applications
- Traffic Control, using the traffic control rules
- Policy-based Routing (PBR), using the PBR rules.

You can use the [show dpi statistics](#) command to show statistics for the applications being inspected by DPI.

For more information about configuring and using DPI, see the [Application Awareness Feature_Overview and Configuration Guide](#) .

Examples To enable DPI to use the built-in library, use the commands:

```
awplus# configure terminal
awplus(config)# dpi
awplus(config-dpi)# provider built-in
awplus(config-dpi)# enable
```

To disable DPI, use the commands:

```
awplus# configure terminal
awplus(config)# dpi
awplus(config-dpi)# no enable
```

Related commands provider (dpi)
show dpi
show running-config dpi

Command changes Version 5.4.7-2.1: command added

hostname (application)

Overview Use this command to specify a hostname used by an application.

An application is a high-level definition of different types of applications being transported by network traffic. For example, social networking.

You associate a hostname or multiple hostnames with an application.

Use the **no** variant of this command to remove a hostname from an application.

Syntax `hostname <hostname>`
`no hostname`

Parameter	Description
<code><hostname></code>	The hostname expressed as a URI (Uniform Resource Identifier).

Default Not set.

Mode Application Configuration

Example To specify a hostname for the Stuff application, use the commands:

```
awplus# configure terminal
awplus(config)# application Stuff
awplus(config-application)# hostname stuff.co.nz
```

To specify an application for Youtube with multiple hostnames, use the commands:

```
awplus# configure terminal
awplus(config)# application Youtube
awplus(config-application)# hostname youtube.com
awplus(config-application)# hostnameyoutu.be
```

To remove a hostname from an application for Youtube, use the commands:

```
awplus# configure terminal
awplus(config)# application Youtube
awplus(config-application)# no hostname youtube.com
```

Related commands [application](#)

Command changes Version 5.5.2-0.1: command added

provider (dpi)

Overview Use this command to set the DPI provider for the library of applications used for DPI to the built-in library predefined in device's operating system. Application awareness uses DPI, if enabled, to identify applications by matching packets to a library of application signatures.

Syntax `provider built-in`

Default No provider is set by default.

Mode DPI Configuration

Usage notes You can use the [show application](#) command and the [show application detail](#) command to view all applications that the device recognizes. If DPI is enabled, the show commands can include the commands in the library specified with this provider command.

Note that custom applications override DPI applications, which override AlliedWare Plus predefined applications. For more information about applications, see the [application](#) command.

Note that you need to use this command before using the [enable \(dpi\)](#) command to enable DPI.

Examples To set the DPI provider to the built-in library of application signatures, use the commands:

```
awplus# configure terminal
awplus(config)# dpi
awplus(config-dpi)# provider built-in
awplus(config-dpi)# enable
```

Related commands

- [enable \(dpi\)](#)
- [show application detail](#)
- [show dpi](#)
- [show running-config dpi](#)

Command changes Version 5.4.7-2.1: command added

show dpi

Overview Use this command to show the DPI configuration state.

Syntax show dpi

Mode Privileged Exec

Examples To show information about the DPI configuration and provider's library, use the command:

```
awplus# show dpi
```

Output Figure 69-1: Example output from **show dpi** with DPI enabled and the provider set to **built-in**

```
awplus#show dpi
Status:      running
Provider:    built-in
```

Table 69-1: Parameters in the output from **show dpi**

Parameter	Description
Status	The status of DPI: <ul style="list-style-type: none">• running—DPI is running — DPI is enabled, and the provided library is available• disabled—DPI is disabled
Provider	The provider for the library of application signatures used to identify applications.

Related commands [enable \(dpi\)](#)
[provider \(dpi\)](#)

Command changes Version 5.4.7-2.1: command added

show dpi statistics

Overview Use this command to display statistics for each application being inspected by DPI. This command gives you counts of the total number of packets and bytes of the applications being inspected by DPI. You can use the [rule \(firewall\)](#) command, traffic control rules or PBR rules to apply rules to the DPI applications.

You can also use this command to display application DPI statistics for an individual entity (zone, network or host). Enable this with the [counters detailed](#) command.

Syntax `show dpi statistics [<entity-name>]`

Parameter	Description
<code><entity-name></code>	The name of an individual entity, for example the name of a zone, network or host.

Mode Privileged Exec

Examples To display the statistics for each application being inspected by DPI, use the command:

```
awplus# show dpi statistics
```

Output Figure 69-2: Example output from the **show dpi statistics** command on the console.

```
awplus#show dpi statistics
Application  Packets          Bytes
-----
http         30               2020
icmp        348              29232
telnet       45               2553
```

To show information about the DPI statistics for an individual entity, for example the entity "joeb", use the command:

```
awplus# show dpi statistics joeb
```

Figure 69-3: Examples output from **show dpi statistics**

```
awplus#show dpi statistics joeb
Statistics for entity: joeb
Application  TX Packets      RX Packets      TX Bytes      RX Bytes
-----
youtube     15413           16542           15412         45123645
google      15413            654            12205         451254
facebook    4115             8153            1100         123588
twitter     15413           4865            35459         24236
```

Table 69-2: Parameters in the output from **show dpi statistics**

Parameter	Description
Application	The application associated with the packet
TX Packets	Transmitted packets
RX Packets	Received packets
TX Bytes	Bytes transmitted
RX Bytes	Bytes received

Related commands [counters detailed](#)

Command changes Version 5.4.7-2.1: command added
Version 5.4.9-1.1: entity parameter added

show running-config dpi

Overview Use this command to show the configuration commands that have been used to configure DPI.

Syntax `show running-config dpi`

Mode Privileged Exec

Examples To show the configuration commands that have been used to configure DPI, use the command:

```
awplus# show running-config dpi
```

Output Figure 69-4: Example output from the **show running-config dpi** command

```
awplus#show running-config dpi
dpi
  provider built-in
  enable
!
```

Command changes Version 5.4.7-2.1: command added

web-categorization

Overview Use this command to configure DPI's web-categorization and optionally a provider. DPI's web-categorization classifies network traffic into provider defined categories (e.g. online auctions, social networking) and/or user defined custom categories.

Use Web-categorization to help protect users on the network based on the type of website they access.

Use the **no** variant of this command to disable web-categorization.

Syntax `web-categorization [digital-arts]`
`no web-categorization`

Parameter	Description
<code>digital-arts</code>	Use the Digital Arts provider and their database of categories.

Default Disabled.

Mode DPI Configuration

Usage notes Web-categorization requires a Web Control subscription license.

Example To enable DPI Web-categorization and set the provider to Digital Arts, use the commands:

```
awplus# configure terminal
awplus(config)# dpi
awplus(config-dpi)# web-categorization digital-arts
```

To enable DPI Web-categorization with no external provider, use the commands:

```
awplus# configure terminal
awplus(config)# dpi
awplus(config-dpi)# web-categorization
```

To disable DPI Web-categorization, use the commands:

```
awplus# configure terminal
awplus(config)# dpi
awplus(config-dpi)# no web-categorization
```

Related commands

- [enable \(dpi\)](#)
- [show dpi statistics](#)
- [show running-config dpi](#)
- [show dpi](#)

Command changes Version 5.5.2-0.1: command added

70

URL Offload Commands

Introduction

Overview This chapter provides an alphabetical reference of commands used to configure URL offload.

You can use these commands to bypass a VPN or proxy server for particular destinations, and then send this traffic direct to the Internet. Destinations to be bypassed (offloaded) are based on provided lists of endpoint URLs or IP addresses. You can both:

- manually configure particular endpoint URLs or IP entries that you want to offload, and
- configure a router to periodically fetch and filter URLs or IP entries from the Microsoft Office365 endpoint service.

The Microsoft Office endpoint service can then automatically update information about which URLs or IP addresses can be offloaded directly to the Internet. This speeds up access to Microsoft Office365 cloud services when your network architecture routes all traffic to a VPN or Proxy server by default.

For more information, see the [URL Offload Feature Overview and Configuration Guide](#).

- Command List**
- [“endpoint-source”](#) on page 3580
 - [“entry \(endpoint-manual\)”](#) on page 3582
 - [“exclude-entry \(endpoint-manual\)”](#) on page 3584
 - [“exclude-entry \(endpoint-office365\)”](#) on page 3586
 - [“filter-endpoint”](#) on page 3588
 - [“filter-endpoint include all”](#) on page 3591
 - [“filter-entry exclude”](#) on page 3593
 - [“filter-entry exclude type”](#) on page 3595
 - [“pac-file http-server port”](#) on page 3597

- [“pac-file proxy-address”](#) on page 3599
- [“pac-file template”](#) on page 3600
- [“parser-updates enable”](#) on page 3602
- [“parser-updates interval”](#) on page 3603
- [“service url-offload”](#) on page 3604
- [“show running-config url-offload”](#) on page 3605
- [“show url-offload endpoint-source”](#) on page 3606
- [“show url-offload endpoint-source manual entries”](#) on page 3607
- [“show url-offload endpoint-source office365 entries”](#) on page 3609
- [“show url-offload endpoint-source office365 raw-data”](#) on page 3612
- [“show url-offload pac-file”](#) on page 3615
- [“show url-offload pac-file template”](#) on page 3619
- [“update-interval \(endpoint-office365\)”](#) on page 3621
- [“url \(endpoint office365\)”](#) on page 3622
- [“url-offload”](#) on page 3623
- [“url-offload update-now”](#) on page 3624

endpoint-source

Overview Use this command to add a new URL offload endpoint source, or to enter the configuration mode for an existing endpoint source.

Use the **no** variant of this command to remove a URL offload endpoint source.

Syntax `endpoint-source <name> type {office365|manual}`
`no endpoint-source <name> type {office365|manual}`

Parameter	Description
<name>	This is the identifier name for the endpoint source. The identifier is unique to the source type. For example, it is possible to create two endpoints with the same name, as long as the type is different.
office365	Configure an endpoint source that uses the Microsoft office365 endpoint service.
manual	Configure an endpoint source that holds manually configured entries.

Default No endpoint source name identifier or type is set.

Mode URL Offload Configuration

Usage notes This command adds a new endpoint source for URL offload. The endpoint source types supported are 'office365' and 'manual'.

Use the 'office365' type to fetch endpoints from the Microsoft Office365 endpoints service.

Use the 'manual' type to manually specify include entries for use with URL offload (see the [entry \(endpoint-manual\)](#) command).

This command enters a new configuration mode. From here you can enter the configuration needed for a specific endpoint type. The mode is dependent on the type of endpoint source.

Example To configure an office365 endpoint source using the name identifier 'test', use the commands:

```
awplus# configure terminal
awplus(config)# url-offload
awplus(config-url-offload)# endpoint-source test type office365
awplus(config-endpoint-office365)#
```

To configure a manual endpoint source using the name identifier 'test', use the commands:

```
awplus# configure terminal
awplus(config)# url-offload
awplus(config-url-offload)# endpoint-source test type manual
awplus(config-endpoint-manual)#
```

**Related
commands**

[show running-config url-offload](#)
[show url-offload endpoint-source](#)
[show url-offload endpoint-source manual entries](#)
[show url-offload endpoint-source office365 entries](#)
[show url-offload endpoint-source office365 raw-data](#)

**Command
changes**

Version 5.5.0-0.1: command added

entry (endpoint-manual)

Overview Use this command to manually add endpoint entries to be included for URL offload. These entries are added to the '%%INCLUDE_CONDITION%%' section of the PAC file along with any other include entries from either manual or automatic sources.

Use the **no** variant of this command to remove the include entry from the endpoint entry list.

Syntax entry {ip|ipv6|url} <value>
no entry {ip|ipv6|url} <value>

Parameter	Description
ip	IPv4 prefix to include for URL offload
ipv6	IPv6 prefix to include for URL offload
url	URL to include for URL offload
<value>	IPv4 prefix, IPv6 prefix, or URL to include for URL offload

Default No addresses are included for URL offload

Mode URL Offload Endpoint Manual Configuration

Usage notes To show the entries that are included for URL offload in the PAC file, use the **show url-offload pack-file** command. You will see the entries listed in the '%%INCLUDE_CONDITION%%' section of the PAC file.

Examples To include the endpoint entry URL 'test.example.com' in the inclusion list for URL offload under manual endpoint source 'test', use the commands:

```
awplus# configure terminal
awplus(config)# url-offload
awplus(config-url-offload)# endpoint-source test type manual
awplus(config-endpoint-manual)# entry url test.example.com
```

To remove the endpoint entry URL 'test.example.com', from the inclusion list for URL offload under manual endpoint source 'test', use the commands:

```
awplus# configure terminal
awplus(config)# url-offload
awplus(config-url-offload)# endpoint-source test type manual
awplus(config-endpoint-manual)# entry url test.example.com
```

To add the endpoint entry IP address '192.168.1.0/24' to the inclusion list for URL offload under manual endpoint source 'test', use the commands:

```
awplus# configure terminal
awplus(config)# url-offload
awplus(config-url-offload)# endpoint-source test type manual
awplus(config-endpoint-manual)# entry ip 192.168.0.1/24
```

**Related
commands**

[exclude-entry \(endpoint-manual\)](#)
[show running-config url-offload](#)
[show url-offload endpoint-source manual entries](#)
[show url-offload pac-file](#)

**Command
changes**

Version 5.5.0-0.1: command added

exclude-entry (endpoint-manual)

Overview Use this command to exclude endpoint entries for URL offload. These entries are added to the '%%EXCLUDE_CONDITION%%' section of the PAC file to be processed before the include entries.

Use the **no** variant of this command to remove endpoint entries from the inclusion list for URL offload.

Syntax `exclude-entry {ip|ipv6|url} <value>`
`no exclude-entry {ip|ipv6|url} <value>`

Parameter	Description
ip	IPv4 prefix to exclude from URL offload
ipv6	IPv6 prefix to exclude from URL offload
url	URL to exclude from URL offload
<value>	IPv4 prefix, IPv6 prefix, or URL to exclude from URL offload

Default No entries are excluded

Mode URL Offload Endpoint Manual Configuration

Usage notes The primary use for this command is if you want to exclude a specific entry that is part of a larger wildcard or subnet entry.

Examples To explicitly exclude 'example.facebook.com' from URL offload under manual endpoint source 'test', use the commands:

```
awplus# configure terminal
awplus(config)# url-offload
awplus(config-url-offload)# endpoint-source test type manual
awplus(config-endpoint-manual)# exclude-entry url
example.facebook.com
```

To remove the exclude entry that prevents 'example.facebook.com' from bypassing the VPN or proxy via URL offload under manual endpoint source 'test', use the commands:

```
awplus# configure terminal
awplus(config)# url-offload
awplus(config-url-offload)# endpoint-source test type manual
awplus(config-endpoint-manual)# no exclude-entry url
example.facebook.com
```

To include all entries for subnet 192.168.1.0/24 for URL offload except 192.168.1.2 under manual endpoint source 'test', use the commands:

```
awplus# configure terminal
awplus(config)# url-offload
awplus(config-url-offload)# endpoint-source test type manual
awplus(config-endpoint-manual)# entry ip 192.168.1.0/24
awplus(config-endpoint-manual)# exclude-entry ip
192.168.1.2/32
```

**Related
commands**

[exclude-entry \(endpoint-office365\)](#)
[entry \(endpoint-manual\)](#)
[show url-offload endpoint-source manual entries](#)
[show url-offload pac-file](#)
[show running-config url-offload](#)

**Command
changes**

Version 5.5.0-0.1: command added

exclude-entry (endpoint-office365)

Overview Use this command to explicitly exclude particular endpoint entries for URL offload. These entries are added to the '%%EXCLUDE_CONDITION%%' section of the PAC file to be processed before the include entries.

Use the **no** variant of this command to remove endpoint entries from the inclusion list for URL offload.

Syntax `exclude-entry {ip|ipv6|url} <value>`
`no exclude-entry {ip|ipv6|url} <value>`

Parameter	Description
ip	IPv4 prefix to exclude from URL offload
ipv6	IPv6 prefix to exclude from URL offload
url	URL to exclude from URL offload
<value>	IPv4 prefix, IPv6 prefix, or URL to exclude from URL offload

Default No entries are excluded

Mode URL Offload Endpoint Office365 Configuration

Usage notes The primary use for this command is to exclude a specific endpoint entry from an endpoint that is included. This command is functionally equivalent to creating an exclude entry as part of a manual source, but is included in the office365 configuration mode to logically group related entries.

Examples To explicitly exclude 'example.facebook.com' from URL offload under office365 endpoint source 'test', use the commands:

```
awplus# configure terminal
awplus(config)# url-offload
awplus(config-url-offload)# endpoint-source test type office365
awplus(config-endpoint-office365)# exclude-entry url
example.facebook.com
```

To remove the exclude entry that prevents 'example.facebook.com' from bypassing the VPN or proxy via URL offload under office365 endpoint source 'test', use the commands:

```
awplus# configure terminal
awplus(config)# url-offload
awplus(config-url-offload)# endpoint-source test type office365
awplus(config-endpoint-office365)# no exclude-entry url
example.facebook.com
```

Related commands

- `exclude-entry (endpoint-manual)`
- `entry (endpoint-manual)`
- `filter-endpoint include all`
- `filter-entry exclude`
- `filter-entry exclude type`
- `show running-config url-offload`
- `show url-offload endpoint-source manual entries`
- `show url-offload endpoint-source office365 entries`
- `show url-offload pac-file`

Command changes

- Version 5.5.0-0.1: command added

filter-endpoint

Overview Use this command to filter the endpoints retrieved from the office365 endpoints service.

Use the **no** variant of this command to remove all filtering.

Syntax

```
filter-endpoint {include|exclude} key <key> boolean  
{true|false}  
filter-endpoint {include|exclude} key <key> string <value>  
filter-endpoint {include|exclude} key <key> integer <value>  
no filter-endpoint
```

Parameter	Description
include	Include endpoints that have this key-value pair.
exclude	Exclude endpoints that have this key-value pair.
key <key>	The name of the key to filter on. The key that you use must exactly match the key in the Microsoft Endpoint data.
boolean {true false}	Specify that the key value is a boolean, and whether it is true or false .
string <value>	Specify that the key value is a string, and what the string is (for example 'Optimize').
integer <value>	Specify that the key value is an integer, and what the integer is (for example 32).

Default No filter entries are included

Mode URL Offload Endpoint Office365 Configuration

Usage notes The endpoints entries retrieved via this service are grouped into endpoints for a particular service and categorized using various 'key-value' pairs. These values are used to filter which endpoints are included for URL offload.

An example of a single endpoint is shown in the output below. At the time of this example the 'worldwide' endpoints list contained 146 endpoints.

Figure 70-1: Example output from **show url-offload endpoint-source office365 entries**

```
{
  "id": 1,
  "serviceArea": "Exchange",
  "serviceAreaDisplayName": "Exchange Online",
  "urls": [
    "outlook.office.com",
    "outlook.office365.com"
  ],
  "ips": [
    "13.107.6.152/31",
    "13.107.18.10/31",
    ...
    "2603:1006::/40",
    "2603:1016::/40",
    "2603:1026::/40",
    ...
    "2a01:111:f400::/48"
  ],
  "tcpPorts": "80,443",
  "expressRoute": true,
  "category": "Optimize",
  "required": true
},
```

You can use include and exclude filters. Use include filters to include whole endpoints in the list (like the example above). Use exclude filters to remove whole endpoints from the list. Exclude filters override include filters.

In this feature, an office365 endpoint is a block like the one shown in the example above. An endpoint entry is a single URL or IP address. This command operates at the level of include or exclude whole endpoints.

Examples To include entries marked as required: true for endpoint source 'test', use the commands:

```
awplus# configure terminal
awplus(config)# url-offload
awplus(config-url-offload)# endpoint-source test type office365
awplus(config-endpoint-office365)# filter-endpoint include key
required boolean true
```

To include all entries except the entry with id: 32 for endpoint source 'test', use the commands:

```
awplus# configure terminal
awplus(config)# url-offload
awplus(config-url-offload)# endpoint-source test type office365
awplus(config-endpoint-office365)# filter-endpoint exclude key
id integer 32
```

To include entries marked as category: Optimize for endpoint source 'test', use the commands:

```
awplus# configure terminal
awplus(config)# url-offload
awplus(config-url-offload)# endpoint-source test type office365
awplus(config-endpoint-office365)# filter-endpoint include key
category string Optimize
```

**Related
commands**

[entry \(endpoint-manual\)](#)
[exclude-entry \(endpoint-manual\)](#)
[filter-endpoint include all](#)
[filter-entry exclude](#)
[filter-entry exclude type](#)
[show running-config url-offload](#)
[show url-offload endpoint-source](#)
[show url-offload endpoint-source manual entries](#)
[show url-offload endpoint-source office365 entries](#)
[show url-offload endpoint-source office365 raw-data](#)
[show url-offload pac-file](#)

**Command
changes**

Version 5.5.0-0.1: command added

filter-endpoint include all

Overview Use this command to include all endpoints from the office365 source. See the Usage notes below before using this command.

Use the **no** variant of this command to disable the inclusion of all endpoints from the office365 source.

Syntax `filter-endpoint include all`
`no filter-endpoint include all`

Default No endpoints are included

Mode URL Offload Endpoint Office365 Configuration

Usage notes Using this command without examining the result and explicitly excluding endpoint entries is not recommended. This is because this command includes URLs for a number of third-party services, for example, Facebook, Google and Dropbox.

Without this command or at least one other include filter, no endpoints will be included.

Example To use all endpoints in the office365 endpoint information for the endpoint source 'test', use the commands:

```
awplus# configure terminal
awplus(config)# url-offload
awplus(config-url-offload)# endpoint-source test type office365
awplus(config-endpoint-office365)# filter-endpoint include all
```

To disable including all endpoints in the office365 endpoint information for the endpoint source 'test', use the commands:

```
awplus# configure terminal
awplus(config)# url-offload
awplus(config-url-offload)# endpoint-source test type office365
awplus(config-endpoint-office365)# no filter-endpoint include all
```

Related commands [exclude-entry \(endpoint-office365\)](#)
[filter-endpoint](#)

[filter-entry exclude](#)

[filter-entry exclude type](#)

[show running-config url-offload](#)

[show url-offload endpoint-source](#)

[show url-offload endpoint-source office365 entries](#)

show url-offload endpoint-source office365 raw-data

show url-offload pac-file

Command changes Version 5.5.0-0.1: command added

filter-entry exclude

Overview Use this command to filter out specific endpoint entries from the list of entries included for URL offload for an office365 endpoint source. The entries are removed from the list of entries stored for the source.

Use the **no** variant of this command to remove an entry from the list.

Syntax `filter-entry exclude {ip|ipv6|url} <value>`
`no filter-entry exclude {ip|ipv6|url} <value>`

Parameter	Description
ip	Filter out entries with the given IPv4 prefix
ipv6	Filter out entries with the given IPv6 prefix
url	Filter out entries with the given URL
<value>	The IPv4 prefix, IPv6 prefix, or URL to exclude.

Default There is no default

Mode URL Offload Endpoint Office365 Configuration

Examples To filter out entries for 'www.example.com' from URL offload under office365 endpoint source 'test', use the commands:

```
awplus# configure terminal
awplus(config)# url-offload
awplus(config-url-offload)# endpoint-source test type office365
awplus(config-url-offload-office365)# filter-entry exclude url
www.example.com
```

To remove the filter entry 'www.example.com', use the commands:

```
awplus# configure terminal
awplus(config)# url-offload
awplus(config-url-offload)# endpoint-source test type office365
awplus(config-url-offload-office365)# no filter-entry exclude
url www.example.com
```

Related commands

- [entry \(endpoint-manual\)](#)
- [exclude-entry \(endpoint-office365\)](#)
- [filter-endpoint include all](#)
- [filter-entry exclude type](#)
- [show running-config url-offload](#)
- [show url-offload endpoint-source office365 entries](#)

show url-offload pac-file

Command changes Version 5.5.0-0.1: command added

filter-entry exclude type

Overview Use this command to explicitly exclude a particular endpoint entry type for URL offload. Entries of this type are removed from the entry list.

Use the **no** variant of this command to stop excluding entry types.

Syntax `filter-entry exclude type {url|ip|ipv6}`
`no filter-entry exclude type {url|ip|ipv6}`

Parameter	Description
url	Filter out URL entries
ip	Filter out IPv4 entries
ipv6	Filter out IPv6 entries

Default All types are included

Mode URL Offload Endpoint Office365 Configuration

Example To exclude IP entries from being stored and included in the PAC file for office365 endpoint source 'test', use the commands:

```
awplus# configure terminal
awplus(config)# url-offload
awplus(config-url-offload)# endpoint-source test type office365
awplus(config-url-offload-office365)# filter-entry exclude ip
```

To stop excluding IP entries from being stored and included in the PAC file for office365 endpoint source 'test', use the commands:

```
awplus# configure terminal
awplus(config)# url-offload
awplus(config-url-offload)# endpoint-source test type office365
awplus(config-url-offload-office365)# no filter-entry exclude ip
```

Related commands

- [entry \(endpoint-manual\)](#)
- [exclude-entry \(endpoint-office365\)](#)
- [filter-endpoint include all](#)
- [filter-entry exclude](#)
- [show running-config url-offload](#)
- [show url-offload endpoint-source office365 entries](#)
- [show url-offload pac-file](#)

Command changes Version 5.5.0-0.1: command added

pac-file http-server port

Overview Use this command to set the HTTP port to use for serving URL offload PAC files. Use the **no** variant of this command to disable serving URL offload PAC files.

Syntax `pac-file http-server port <port>`
`no pac-file http-server`

Parameter	Description
<port>	The port number you want to use to serve the PAC file, in the range 1 to 65535.

Default Disabled

Mode URL Offload Configuration

Usage notes Use this command to configure the router to serve Proxy Auto-Configuration (PAC) files that are generated by the URL offload feature. If configured, an HTTP service is provided on the configured port that serves a PAC file with the name extension 'wpad.dat'.

The port number may be the same as the main management HTTP web server, but if it is, requests may be redirected to the HTTPS secure port.

The main reason for choosing a non-default port number is to allow locking down access to the management HTTP server, to specific hosts without blocking the access that all clients need to download the PAC file.

NOTE: Attempting to assign a port that is bound to another service may cause your device to restart.

Examples To serve the PAC file on port 80, use the commands:

```
awplus# configure terminal
awplus(config)# url-offload
awplus(config-url-offload)# pac-file http-server port 80
```

To disable serving the PAC file on port 80, use the commands:

```
awplus# configure terminal
awplus(config)# url-offload
awplus(config-url-offload)# no pac-file http-server
```

Related commands [pac-file proxy-address](#)
[show running-config url-offload](#)
[show url-offload pac-file](#)
[show url-offload pac-file template](#)

Command changes Version 5.5.0-0.1: command added

pac-file proxy-address

Overview Use this command to configure a proxy address to use in the Proxy Auto-Configuration (PAC) file generated by URL offload.
Use the **no** variant of this command to remove the configured proxy address.

Syntax `pac-file proxy-address <address>`
`no pac-file proxy-address`

Parameter	Description
<code><address></code>	Proxy address to use in the generated PAC file. We recommend to use an IP address, but you can also use a host name or URL.

Default No proxy address is set

Mode URL Offload Configuration

Usage notes Use this command to configure the proxy address to use in the PAC file generated by URL offload. This address is a text string. If you use a non-default PAC file template, it replaces the placeholder '%%PROXY_ADDRESS%%' in the template.
The proxy address can be a host name, URL, or IP address with a port number.

Example To configure the proxy address 10.10.10.10 on port 8080, use the commands:

```
awplus# configure terminal
awplus(config)# url-offload
awplus(config-url-offload)# pac-file proxy-address
10.10.10.10:8080
```

To unset the proxy address 10.10.10.10 on port 8080, use the commands:

```
awplus# configure terminal
awplus(config)# url-offload
awplus(config-url-offload)# no pac-file proxy-address
```

Related commands [show running-config url-offload](#)
[show url-offload pac-file](#)
[show url-offload pac-file template](#)

Command changes Version 5.5.0-0.1: command added

pac-file template

Overview Use this command to configure a custom (instead of the default) template to use for URL offload.

Use the **no** variant of this command to revert back to the default template to use for URL offload.

Syntax `pac-file template {local|remote} <url>`
`no pac-file template`

Parameter	Description
local	Use a template file stored on the local file system of your device
remote	Use a template file fetched via HTTP
<url>	For the local option, URLs must start with 'flash','usb' or 'card'. The file must exist at one of these locations. For the remote option, a URL is used. No validation is performed on the URL, but the URL should point to a PAC file template with the required placeholders.

Default Default PAC file template

Mode URL Offload Configuration

Usage notes The template can be stored in the file system of your device, or fetched from a remote server using HTTP. Both of these options cause the URL offload feature to fetch the template when updating the PAC file. A cached version of the template is used if multiple updates occur within a 1 minute time period.

The template must include two placeholders '%%EXCLUDE_MATCHES%%' and '%%INCLUDE_MATCHES%%'. These are replaced by the relevant condition statements. The template may also include the '%%PROXY_ADDRESS%%' placeholder. If it does, this is replaced by the proxy address configured using the command **pac-file proxy-address** in URL Offload Configuration mode.

NOTE: *Exclude conditions should always be processed before include conditions.*

Using the command **show url-offload pac-file template** shows the contents of the template that is being used. Running this command before configuring a template shows the default template. The default template has an example of how to write a template.

Example To use the file 'pac_template.pac' in the device flash as the template, use the commands:

```
awplus# configure terminal
awplus(config)# url-offload
awplus(config-url-offload)# pac-file template local
flash:/pac_template.pac
```

To use the PAC file template 'remote_pac_template.pac' stored on a (reachable) HTTP server at 192.168.1.2, use the commands:

```
awplus# configure terminal
awplus(config)# url-offload
awplus(config-url-offload)# pac-file template remote
http://192.168.1.2/remote_pac_template.pac
```

To revert back to the default template, use the commands:

```
awplus# configure terminal
awplus(config)# url-offload
awplus(config-url-offload)# no pac-file template
```

**Related
commands**

[pac-file proxy-address](#)
[show running-config url-offload](#)
[show url-offload pac-file](#)
[show url-offload pac-file template](#)

**Command
changes**

Version 5.5.0-0.1: command added

parser-updates enable

Overview Use this command to enable automatic updates of the parsing functionality used by URL offload via the Allied Telesis Update Server.

Use the **no** variant of this command to disable automatic updates of the parsing functionality used by URL offload via the Allied Telesis Update Server.

Syntax `parser-updates enable`
`no parser-updates enable`

Default Disabled

Mode URL Offload Configuration

Example To enable the automatic updates, use the commands:

```
awplus# configure terminal
awplus(config)# url-offload
awplus(config-url-offload)# parser-updates enable
```

To disable the automatic updates, use the commands:

```
awplus# configure terminal
awplus(config)# url-offload
awplus(config-url-offload)# no parser-updates enable
```

Related commands [parser-updates interval](#)
[show running-config url-offload](#)

Command changes Version 5.5.0-0.1: command added

parser-updates interval

Overview Use this command to configure the parsing interval for periodic updates via the Allied Telesis update server.

Use the **no** variant of this command to set the interval back to the default (60 minutes).

Syntax `parser-updates interval {minutes <10-525600>|hours <1-8760>|days <1-365>|weeks <1-52>}`
`no parser-updates interval`

Parameter	Description
<code>minutes <10-525600></code>	Configure the interval in minutes, in the range 10 to 525600
<code>hours <1-8760></code>	Configure the interval in hours, in the range 1 to 8760
<code>days <1-365></code>	Configure the interval in days, in the range 1 to 365
<code>weeks <1-52></code>	Configure the interval in weeks, in the range 1 to 52

Default 60 minutes

Mode URL Offload Configuration

Examples To set the parser updates interval to 180 minutes, use the commands:

```
awplus# configure terminal
awplus(config)# url-offload
awplus(config-url-offload)# parser-updates interval minutes 180
```

To set the parser updates interval back to the default value (60 minutes), use the commands:

```
awplus# configure terminal
awplus(config)# url-offload
awplus(config-url-offload)# no parser-updates interval
```

Related commands [parser-updates enable](#)
[show running-config url-offload](#)

Command changes Version 5.5.0-0.1: command added

service url-offload

Overview Use this command to enable the URL offload service.

Use the **no** version of the command to disable the URL offload service if it is unused.

Syntax `service url-offload`
`no service url-offload`

Default Enabled

Mode Global Configuration

Usage notes Sometimes it may be desirable to disable unused services, in order to reduce memory use. This command lets you disable the URL offload service.

Example To disable the URL offload service, use the commands:

```
awplus# configure terminal
awplus(config)# no service url-offload
```

Command changes Version 5.5.0-0.1: command added

show running-config url-offload

Overview Use this command to show the current configuration for the URL offload feature.

Syntax `show running-config url-offload`

Mode Privileged Exec

Example To show the current URL offload configuration, use the command:

```
awplus# show running-config url-offload
```

Output Figure 70-2: Example output from **show running-config url-offload**

```
url-offload
endpoint-source test type office365
  url https://endpoints.office.com/endpoints/worldwide
  update-interval hours 1
  filter-endpoint include key category string Optimize
  filter-entry exclude type ip
pac-file proxy-address 10.10.10.10:8080
pac-file http-server port 80
pac-file template local flash:/wpad.template
!
```

Related commands

- [show url-offload endpoint-source manual entries](#)
- [show url-offload endpoint-source office365 entries](#)
- [show url-offload endpoint-source office365 raw-data](#)
- [show url-offload pac-file](#)

Command changes Version 5.5.0-0.1: command added

show url-offload endpoint-source

Overview Use this command to show information about configured URL offload endpoint sources.

Syntax `show url-offload endpoint-source`

Mode Privileged Exec

Usage notes For Office365 type sources, the name, URL, update interval and last update time are shown. For manual type sources, only the name is shown.

Example To show information about configured URL offload endpoint sources, use the commands:

```
awplus# show url-offload endpoint-source
```

Output Figure 70-3: Example output from **show url-offload endpoint-source**

```
awplus#show url-offload endpoint-source

Microsoft Office365 endpoint sources:

Name: test
URL: https://endpoints.office.com/endpoints/worldwide
Update interval: 1 hours
Update time: 2019-10-02T12:56:21Z

Manual endpoint sources:

Name: manual_test
```

Related commands [endpoint-source](#)
[update-interval \(endpoint-office365\)](#)
[url-offload](#)

Command changes Version 5.5.0-0.1: command added

show url-offload endpoint-source manual entries

Overview Use this command to show endpoint entries for a URL offload manual endpoint source. Manually configured entries attached to an endpoint source are displayed.

Syntax `show url-offload endpoint-source manual entries`
`show url-offload endpoint-source manual <name> entries`

Parameter	Description
<name>	The name of the manual endpoint source, for example 'test'.

Mode Privileged Exec

Usage notes Use the optional parameter to display a specific endpoint source by its <name>. If no parameter is used, then all endpoint entries for all manual endpoint sources are displayed.

Examples To show endpoint entries for manual endpoint source 'test', use the command:

```
awplus# show url-offload endpoint-source manual test entries
```

To show endpoint entries for all manual endpoint sources, use the command:

```
awplus# show url-offload endpoint-source manual entries
```

Output Figure 70-4: Example output from **show url-offload endpoint-source manual test entries**

```
awplus#show url-offload endpoint-source manual test entries
Name: test

Include Entries:
  Type: url
  Value: *.example.com

  Type: ip
  Value: 192.168.1.0/24

Exclude Entries:
  Type: url
  Value: test.example.com

  Type: ip
  Value: 192.168.1.1/32
```

Related commands [entry \(endpoint-manual\)](#)

Command changes Version 5.5.0-0.1: command added

show url-offload endpoint-source office365 entries

Overview Use this command to show endpoint entries for office365 endpoints.

Syntax `show url-offload endpoint-source office365 <name> entries [filtered|unusable]`
`show url-offload endpoint-source office365 entries [filtered|unusable]`

Parameter	Description
<name>	This is the name of an endpoint source, for example 'test'. If you do not use this parameter, then all endpoint sources are displayed.
filtered	Use this parameter to show entries that are included, or explicitly excluded, for this source.
unusable	Use this parameter to show URLs and IPs from the endpoint information that can not be used to create entries. For example, this is usually because there is a missing full stop after a wildcard.

Mode Privileged Exec

Usage notes Entries that are displayed using this command are parsed from the information fetched from the endpoint service. You can show all parsed entries, or only entries that are included or excluded using the **filtered** parameter.

Examples To show all the parsed endpoint entries for the endpoint source 'test', use the command:

```
awplus# show url-offload endpoint-source office365 test entries
```

To show endpoint entries specifically included or excluded for the endpoint source 'test', use the command:

```
awplus# show url-offload endpoint-source office365 test entries filtered
```

To show endpoint entries that can't be parsed for the endpoint source 'test', use the command:

```
awplus# show url-offload endpoint-source office365 test entries unusable
```

Output Figure 70-5: Example output from **show url-offload endpoint-source office365 test entries filtered**

```
awplus#show url-offload endpoint-source office365 test entries filtered
Endpoint source: test
Include entries:
Type  Value
-----
ip    13.107.6.152/31
ip    13.107.18.10/31
...
ip    150.171.40.0/22
ip    191.234.140.0/22
ip    204.79.197.215/32
ipv6  2603:1006::/40
...
ipv6  2a01:111:f402::/48
url   *.sharepoint.com
url   outlook.office.com
url   outlook.office365.com

Exclude entries:
Type  Value
-----
url   mobile.facebook.com
```

Figure 70-6: Example output from **show url-offload endpoint-source office365 test entries unusable**

```
awplus#show url-offload endpoint-source office365 test entries unusable
Endpoint source: test
Unusable entries
-----
*~files.sharepoint.com
*~myfiles.sharepoint.com
*broadcast.officeapps.live.com
*cdn.onenote.net
*excel.officeapps.live.com
*onenote.officeapps.live.com
*powerpoint.officeapps.live.com
*rtc.officeapps.live.com
*shared.officeapps.live.com
*view.officeapps.live.com
*visio.officeapps.live.com
*word-edit.officeapps.live.com
*word-view.officeapps.live.com
```

- Related commands**
- [exclude-entry \(endpoint-office365\)](#)
 - [filter-endpoint](#)
 - [filter-endpoint include all](#)
 - [filter-entry exclude](#)
 - [filter-entry exclude type](#)
 - [show url-offload endpoint-source office365 raw-data](#)

Command changes Version 5.5.0-0.1: command added

show url-offload endpoint-source office365 raw-data

Overview Use this command to show the raw JSON data fetched from the Microsoft Office365 endpoint service for diagnostic and configuration debug purposes.

Syntax `show url-offload endpoint-source office365 <name> raw-data`

Parameter	Description
<code><name></code>	This is the name of an endpoint source, for example 'test'. If you do not use this parameter, then all endpoint sources are displayed.

Mode Privileged Exec

Usage notes Use this command to work out what filtering you require. The output is quite long.

Example To show raw JSON data fetched from the office365 endpoint source 'test', use the command:

```
awplus# show url-offload endpoint-source office365 test  
raw-data
```

Output Figure 70-7: Example output from **show url-offload endpoint-source office365 raw-data**

```
awplus#show url-offload endpoint-source office365 test raw-data
[
  {
    "id": 1,
    "serviceArea": "Exchange",
    "serviceAreaDisplayName": "Exchange Online",
    "urls": [
      "outlook.office.com",
      "outlook.office365.com"
    ],
    "ips": [
      "13.107.6.152/31",
      "13.107.18.10/31",
      "13.107.128.0/22",
      "40.96.0.0/13",
      "40.104.0.0/15",
      "52.96.0.0/14",
      "131.253.33.215/32",
      "132.245.0.0/16",
      "191.234.140.0/22",
      "204.79.197.215/32",
      "2603:1006::/40",
      "2603:1016::/40",
      "2603:1026::/40",
      "2603:1026:200::/39",
      "2603:1026:400::/39",
      "2603:1026:620::/44",
      "2603:1026:800::/44",
      "2603:1036::/39",
      ...
    ],
    "tcpPorts": "80,443",
    "expressRoute": true,
    "category": "Optimize",
    "required": true
  },
  {
    "id": 2,
    ...
  },
  {
    "id": 146,
    "serviceArea": "Skype",
    "serviceAreaDisplayName": "Skype for Business Online and
Microsoft Teams",
    "urls": [
      "statics.teams.microsoft.com"
    ],
    "tcpPorts": "443",
    "expressRoute": false,
    "category": "Default",
    "required": true
  }
]
```

Related commands [filter-endpoint](#)
[filter-endpoint include all](#)
[filter-entry exclude](#)
[filter-entry exclude type](#)

Command changes Version 5.5.0-0.1: command added

show url-offload pac-file

Overview Use this command to show the contents of the Proxy Auto-Configuration (PAC) file generated by the URL offload feature.

Syntax `show url-offload pac-file`

Mode Privileged Exec

Example To show the contents of the PAC file generated by URL offload, use the command:

```
awplus# show url-offload pac-file
```

Output Figure 70-8: Example output from **show url-offload pac-file**

```
awplus#show url-offload pac-file
function UO_dnsResolve(host)
{
    return (typeof dnsResolveEx === "function" ? dnsResolveEx(host):
                                                    dnsResolve(host));
}

function UO_isInNet(host_ips, network, mask, full_addr)
{
    const addrList = host_ips.split(";");
    for(let i = 0; i < addrList.length; i++)
    {
        const match = (typeof isInNetEx === "function" ?
                        isInNetEx(addrList[i], full_addr):
                        isInNet(addrList[i], network, mask));

        if (match)
        {
            return true;
        }
    }
    return false;
}
```

```
function FindProxyForURLEx(url, host)
{
    var direct = "DIRECT";
    var proxyServer = "PROXY ";

    /* Host is on local network (no dots in name) */
    if (isPlainHostName (host))
    {
        return direct;
    }

    /* Exclude matches */
    if(shExpMatch (host, "exclude.example.com"))
    {
        return proxyServer;
    }

    /* Include matches */
    if(shExpMatch (host, "*.example.com")
        || shExpMatch (host, "*.sharepoint.com")
        || shExpMatch (host, "outlook.office.com")
        || shExpMatch (host, "outlook.office365.com")
        || (isResolvable(host) && (host_ips = UO_dnsResolve(host))
            && (UO_isInNet(host_ips, "13.107.6.152", "255.255.255.254",
"13.107.6.152/31")
                || UO_isInNet(host_ips, "13.107.18.10", "255.255.255.254",
"13.107.18.10/31")
                || UO_isInNet(host_ips, "13.107.64.0", "255.255.192.0",
"13.107.64.0/18")
                || UO_isInNet(host_ips, "13.107.128.0", "255.255.252.0",
"13.107.128.0/22")
                || UO_isInNet(host_ips, "13.107.136.0", "255.255.252.0",
"13.107.136.0/22")
                || UO_isInNet(host_ips, "23.103.160.0", "255.255.240.0",
"23.103.160.0/20")
                || UO_isInNet(host_ips, "40.96.0.0", "255.248.0.0", "40.96.0.0/13")
                || UO_isInNet(host_ips, "40.104.0.0", "255.254.0.0", "40.104.0.0/15")
                || UO_isInNet(host_ips, "40.108.128.0", "255.255.128.0",
"40.108.128.0/17")
                || UO_isInNet(host_ips, "52.96.0.0", "255.252.0.0", "52.96.0.0/14")
                || UO_isInNet(host_ips, "52.104.0.0", "255.252.0.0", "52.104.0.0/14")
                || UO_isInNet(host_ips, "52.112.0.0", "255.252.0.0", "52.112.0.0/14")
                || UO_isInNet(host_ips, "104.146.128.0", "255.255.128.0",
"104.146.128.0/17")
                || UO_isInNet(host_ips, "131.253.33.215", "255.255.255.255",
"131.253.33.215/32")
                || UO_isInNet(host_ips, "132.245.0.0", "255.255.0.0",
"132.245.0.0/16")
                || UO_isInNet(host_ips, "150.171.32.0", "255.255.252.0",
"150.171.32.0/22")
                || UO_isInNet(host_ips, "150.171.40.0", "255.255.252.0",
"150.171.40.0/22")
                || UO_isInNet(host_ips, "191.234.140.0", "255.255.252.0",
"191.234.140.0/22"))
            return direct;
        )
        return proxyServer;
    }
}
```

```
    || UO_isInNet(host_ips, "191.234.140.0", "255.255.252.0",  
"191.234.140.0/22")  
    || UO_isInNet(host_ips, "204.79.197.215", "255.255.255.255",  
"204.79.197.215/32")  
    || UO_isInNet(host_ips, "2603:1006::", "40", "2603:1006::/40")  
    || UO_isInNet(host_ips, "2603:1016::", "36", "2603:1016::/36")  
    || UO_isInNet(host_ips, "2603:1026::", "36", "2603:1026::/36")  
    || UO_isInNet(host_ips, "2603:1036::", "36", "2603:1036::/36")  
    || UO_isInNet(host_ips, "2603:1046::", "36", "2603:1046::/36")  
    || UO_isInNet(host_ips, "2603:1056::", "36", "2603:1056::/36")  
    || UO_isInNet(host_ips, "2603:1096::", "38", "2603:1096::/38")  
    || UO_isInNet(host_ips, "2603:1096:400::", "40",  
"2603:1096:400::/40")  
    || UO_isInNet(host_ips, "2603:1096:600::", "40",  
"2603:1096:600::/40")  
    || UO_isInNet(host_ips, "2603:1096:a00::", "39",  
"2603:1096:a00::/39")  
    || UO_isInNet(host_ips, "2603:1096:c00::", "40",  
"2603:1096:c00::/40")  
    || UO_isInNet(host_ips, "2603:10a6:200::", "40",  
"2603:10a6:200::/40")  
    || UO_isInNet(host_ips, "2603:10a6:400::", "40",  
"2603:10a6:400::/40")  
    || UO_isInNet(host_ips, "2603:10a6:600::", "40",  
"2603:10a6:600::/40")  
    || UO_isInNet(host_ips, "2603:10a6:800::", "40",  
"2603:10a6:800::/40")  
    || UO_isInNet(host_ips, "2603:10d6:200::", "40",  
"2603:10d6:200::/40")  
    || UO_isInNet(host_ips, "2620:1ec:4::152", "128",  
"2620:1ec:4::152/128")  
    || UO_isInNet(host_ips, "2620:1ec:4::153", "128",  
"2620:1ec:4::153/128")  
    || UO_isInNet(host_ips, "2620:1ec:c::10", "128",  
"2620:1ec:c::10/128")  
    || UO_isInNet(host_ips, "2620:1ec:c::11", "128",  
"2620:1ec:c::11/128")  
    || UO_isInNet(host_ips, "2620:1ec:d::10", "128",  
"2620:1ec:d::10/128")  
    || UO_isInNet(host_ips, "2620:1ec:d::11", "128",  
"2620:1ec:d::11/128")  
    || UO_isInNet(host_ips, "2620:1ec:8f0::", "46", "2620:1ec:8f0::/46")  
    || UO_isInNet(host_ips, "2620:1ec:8f8::", "46", "2620:1ec:8f8::/46")  
    || UO_isInNet(host_ips, "2620:1ec:900::", "46", "2620:1ec:900::/46")  
    || UO_isInNet(host_ips, "2620:1ec:908::", "46", "2620:1ec:908::/46")  
    || UO_isInNet(host_ips, "2620:1ec:a92::152", "128",  
"2620:1ec:a92::152/128")  
    || UO_isInNet(host_ips, "2620:1ec:a92::153", "128",  
"2620:1ec:a92::153/128")  
    || UO_isInNet(host_ips, "2a01:111:f400::", "48",  
"2a01:111:f400::/48")  
    || UO_isInNet(host_ips, "2a01:111:f402::", "48",  
"2a01:111:f402::/48"))))
```

```
{
    return direct;
}

return proxyServer;
}

function FindProxyForURL(url, host)
{
    return FindProxyForURLEx (url, host);
}
```

Related commands

- [entry \(endpoint-manual\)](#)
- [exclude-entry \(endpoint-manual\)](#)
- [exclude-entry \(endpoint-office365\)](#)
- [filter-entry exclude type](#)
- [pac-file proxy-address](#)
- [pac-file template](#)

Command changes Version 5.5.0-0.1: command added

show url-offload pac-file template

Overview Use this command to show the template that is currently used to generate the Proxy Auto-Configuration (PAC) file for the URL offload feature.

Syntax `show url-offload pac-file template`

Mode Privileged Exec

Usage notes The template must include two placeholders '%%EXCLUDE_MATCHES%%' and '%%INCLUDE_MATCHES%%'. These are replaced by the relevant condition statements. The template may also include the '%%PROXY_ADDRESS%%' placeholder. If it does, this is replaced by the proxy address configured using the command **pac-file proxy address** in URL Offload Configuration mode.

NOTE: *Exclude conditions should always be processed before include conditions.*

The default template can be shown, and then used as an example when writing a different template.

Example To display the default template that is currently in use, use the command:

```
awplus# show url-offload pac-file template
```

Output Figure 70-9: Example output from **show url-offload pac-file template**

```
awplus#show url-offload pac-file template

function FindProxyForURLEx(url, host)
{
    var direct = "DIRECT";
    var proxyServer = "PROXY %%PROXY_ADDRESS%%";

    /* Host is on local network (no dots in name) */
    if (isPlainHostName (host))
    {
        return direct;
    }

    /* Exclude matches */
    if (%%EXCLUDE_MATCHES%%)
    {
        return proxyServer;
    }

    /* Include matches */
    if (%%INCLUDE_MATCHES%%)
    {
        return direct;
    }

    return proxyServer;
}

function FindProxyForURL(url, host)
{
    return FindProxyForURLEx (url, host);
}
```

Related commands

- [pac-file proxy-address](#)
- [pac-file template](#)
- [show running-config url-offload](#)
- [show url-offload pac-file](#)

Command changes Version 5.5.0-0.1: command added

update-interval (endpoint-office365)

Overview Use this command to configure the update interval for URL offload office365 endpoints.

Use the **no** variant of this command to disable automatic updating for URL offload office365 endpoints. You can use the **url-offload update-now** command to update the endpoints if you want to.

Syntax `update-interval {days <1-30>|hours <1-720>|minutes <1-43200>}`
`no update-interval`

Parameter	Description
<code>days <1-30></code>	Specify the update interval in days, in the range 1 to 30
<code>hours <1-720></code>	Specify the update interval in hours, in the range 1 to 720
<code>minutes <1-43200></code>	Specify the update interval in minutes, in the range 1 to 43200

Default Disabled

Mode URL Offload Endpoint Office365 Configuration

Examples To update the endpoint source 'test' at hourly intervals, use the commands:

```
awplus# configure terminal
awplus(config)# url offload
awplus(config-url-offload)# endpoint-source test type office365
awplus(config-endpoint-office365)# update-interval hours 1
```

To disable automatic updates, use the commands:

```
awplus# configure terminal
awplus(config)# url offload
awplus(config-url-offload)# endpoint-source test type office365
awplus(config-endpoint-office365)# no update-interval
```

Related commands [show running-config url-offload](#)
[show url-offload endpoint-source](#)
[url-offload update-now](#)

Command changes Version 5.5.0-0.1: command added

url (endpoint office365)

Overview Use this command to set the URL to use as the source for the office365 endpoint service.

Use the **no** variant of this command to remove the configured URL as the source for the office365 endpoints service.

Syntax url <url>
no url

Parameter	Description
<url>	The URL address to use to fetch the JSON data from the office365 endpoints service.

Default No URL is configured

Mode URL Offload Endpoint Office365 Configuration

Examples To configure the URL so you can use the office365 endpoint service, use the commands:

```
awplus# configure terminal
awplus(config)# url-offload
awplus(config-url-offload)# endpoint-source test type office365
awplus(config-endpoint-office365)# url
https://endpoints.office.com/endpoints/worldwide
```

To remove the configured URL for the office365 endpoint service, use the commands:

```
awplus# configure terminal
awplus(config)# url-offload
awplus(config-url-offload)# endpoint-source test type office365
awplus(config-endpoint-office365)# no url
```

Related commands [show running-config url-offload](#)
[show url-offload endpoint-source](#)

Command changes Version 5.5.0-0.1: command added

url-offload

Overview Use this command to enter configuration mode for the URL offload feature.

Syntax url-offload

Mode Global Configuration

Usage notes URL offload allows you to divert particular URL traffic directly to the Internet, rather than sending it to a proxy server or VPN.

Example To enter configuration mode for the URL offload feature, use the commands:

```
awplus# configure terminal
awplus(config)# url-offload
awplus(config-url-offload)#
```

Related commands [show running-config url-offload](#)

Command changes Version 5.5.0-0.1: command added

url-offload update-now

Overview Use this command to trigger an immediate update of all URL offload endpoints. The latest endpoint data is fetched and the PAC file is regenerated.

Syntax `url-offload update-now`

Mode Privileged Exec

Example To trigger an immediate update of all URL offload endpoint data, use the command:

```
awplus# url-offload update-now
```

Related commands [show running-config url-offload](#)
[show url-offload pac-file](#)

Command changes Version 5.5.0-0.1: command added

Part 10: Virtual Private Networks (VPNs)

71

IPsec Commands

Introduction

Overview This chapter provides an alphabetical reference of commands used to configure Internet Protocol Security (IPsec) tunnel.

For introductory information about IPsec tunnel in AlliedWare Plus, including overview and configuration information, see the:

- [Internet Protocol Security \(IPsec\) Feature Overview and Configuration Guide](#)
- [GRE and Multipoint VPNs Feature Overview and Configuration Guide](#)

- Command List**
- [“clear isakmp sa”](#) on page 3628
 - [“crypto ipsec profile”](#) on page 3629
 - [“crypto isakmp key”](#) on page 3631
 - [“crypto isakmp peer”](#) on page 3634
 - [“crypto isakmp profile”](#) on page 3636
 - [“debug isakmp”](#) on page 3638
 - [“dpd-interval”](#) on page 3640
 - [“dpd-timeout”](#) on page 3641
 - [“interface tunnel \(IPsec\)”](#) on page 3642
 - [“lifetime \(IPsec Profile\)”](#) on page 3643
 - [“lifetime \(ISAKMP Profile\)”](#) on page 3644
 - [“no debug isakmp”](#) on page 3645
 - [“pfs”](#) on page 3646
 - [“rekey”](#) on page 3648
 - [“show debugging isakmp”](#) on page 3649
 - [“show interface tunnel \(IPsec\)”](#) on page 3650

- [“show ipsec counters”](#) on page 3652
- [“show ipsec peer”](#) on page 3653
- [“show ipsec policy”](#) on page 3654
- [“show ipsec profile”](#) on page 3655
- [“show ipsec sa”](#) on page 3657
- [“show isakmp counters”](#) on page 3658
- [“show isakmp key \(IPsec\)”](#) on page 3659
- [“show isakmp peer”](#) on page 3660
- [“show isakmp profile”](#) on page 3661
- [“show isakmp sa”](#) on page 3663
- [“show tunnel inline-processing counters”](#) on page 3664
- [“transform \(IPsec Profile\)”](#) on page 3666
- [“transform \(ISAKMP Profile\)”](#) on page 3667
- [“tunnel destination \(IPsec\)”](#) on page 3669
- [“tunnel inline-processing”](#) on page 3671
- [“tunnel local name \(IPsec\)”](#) on page 3672
- [“tunnel local selector”](#) on page 3673
- [“tunnel mode ipsec”](#) on page 3675
- [“tunnel oper-status-control”](#) on page 3676
- [“tunnel protection ipsec \(IPsec\)”](#) on page 3679
- [“tunnel remote name \(IPsec\)”](#) on page 3680
- [“tunnel remote selector”](#) on page 3681
- [“tunnel security-reprocessing”](#) on page 3683
- [“tunnel selector paired”](#) on page 3684
- [“tunnel source \(IPsec\)”](#) on page 3685
- [“undebg isakmp”](#) on page 3687
- [“version \(ISAKMP\)”](#) on page 3688

clear isakmp sa

Overview Use this command to delete Internet Security Association Key Management Protocol (ISAKMP) Security Associations (SAs). SAs specify the Security Parameter Index (SPI), protocols, algorithms and keys for protecting a single flow of traffic between two IPsec peers. For more information about SA, see the [Internet Protocol Security \(IPSec\) Feature Overview and Configuration Guide](#).

Syntax `clear [crypto] isakmp sa [peer <ipv4-addr>|<ipv6-addr>|<hostname>] [force]`

Parameter	Description
<ipv4-addr>	Destination IPv4 address. The IPv4 address uses the format A.B.C.D.
<ipv6-addr>	Destination IPv6 address. The IPv4 address uses the format X:X::X:X.
<hostname>	Destination host name.
force	Force to clear ISAKMP SAs without negotiating with the peer.

Mode Privileged Exec

Examples To delete the ISAKMP security associations at the peer for an IPv6 address, use the command:

```
awplus# clear isakmp sa peer 2001:0db8::1
```

To delete the ISAKMP security associations at the peer for an IPv4 address, use the command:

```
awplus# clear isakmp sa peer 192.168.2.1
```

To delete the ISAKMP security associations at the peer for a host name, use the command:

```
awplus# clear isakmp sa peer remote.example.com
```

Related commands [crypto isakmp key](#)
[show isakmp sa](#)

Command Changes Version 5.4.7-0.1: Parameter <hostname> added for DDNS feature.

crypto ipsec profile

Overview Use this command to configure a custom IPsec profile.

An IPsec profile comprises one or more transforms that can be configured by using the [transform \(IPsec Profile\)](#) command.

Use the **no** variant to delete a previously created profile.

Syntax `crypto ipsec profile <profile_name>`
`no crypto ipsec profile <profile_name>`

Parameter	Description
<code><profile_name></code>	Profile name. Profile names are case insensitive and can be up to 64 characters long composed of printable ASCII characters. Profile names can have only letters from a to z and A to Z, numbers from 0 to 9, - (dash), or _ (underscore).

Default The default IPsec profile with transforms in order of preference is listed in the following table. Which IPsec profile will actually be used depends on how the negotiation between the peers is carried out when establishing the connection. Note that you cannot delete or edit the default profile. Expiry time of 8 hours applies to the default IPsec profile.

Table 71-1: IPsec default profile

Attribute	Transform 1	Transform 2	Transform 3	Transform 4	Transform 5	Transform 6
Protocol	ESP	ESP	ESP	ESP	ESP	ESP
Encryption (all CBC)	AES256	AES256	AES128	AES128	3DES	3DES
Integrity (all HMAC)	SHA256	SHA1	SHA256	SHA1	SHA256	SHA1

Mode Global Configuration

Examples To configure a custom IPsec profile for establishing IPsec SAs with a remote peer, use the following commands:

```
awplus# configure terminal
awplus(config)# crypto ipsec profile my_profile
awplus(config-ipsec-profile)# transform 2 protocol esp
integrity sha1 encryption 3des
```

To delete a custom profile, use the following commands:

```
awplus# configure terminal
awplus(config)# no crypto ipsec profile my_profile
```

**Related
commands** lifetime (IPsec Profile)
 show ipsec profile
 transform (IPsec Profile)

crypto isakmp key

Overview Use this command to configure an ISAKMP authentication key. These keys can be of type Pre-shared Key (PSK) or Extensible Authentication Protocol (EAP). Keys are stored encrypted in the running-configuration.

You must configure this key whenever you specify authentication keys in an (Internet Key Exchange) IKE policy and at both peers.

This command specifies both the value of the key and also an identifier (the hostname, address or policy parameters). This identifier is used to decide which key to use for a particular ISAKMP message exchange.

See the Usage section below for more information, and see the following guides for examples:

- [Internet Protocol Security \(IPsec\) Feature Overview and Configuration Guide](#)
- [GRE and Multipoint VPNs Feature Overview and Configuration Guide](#)

Use the **no** variant to remove a key.

Syntax

```
crypto isakmp key [8] <key> hostname <hostname> [type {eap|psk}]
no crypto isakmp key [8] <key> hostname <hostname> [type {eap|psk}]

crypto isakmp key [8] <key> address {<ipv4-addr>|<ipv6-addr>} [type {eap|psk}]
no crypto isakmp key [8] <key> address {<ipv4-addr>|<ipv6-addr>} [type {eap|psk}]

crypto isakmp key [8] <key> policy <policy-name> [type {eap|psk}]
no crypto isakmp key [8] <key> policy <policy-name> [type {eap|psk}]
```

Parameter	Description
crypto	Security specific command.
isakmp	Internet Security Association Key Management Protocol provides a common framework for key management implementations.
key	Pre-shared key (PSK) or Extensible Authentication Protocol (EAP).
<key>	Specify the key. Use any combination of alphanumeric characters up to 128 bytes.
8	Specifies that an encrypted key follows.
<hostname>	A hostname (e.g. example.com).
<ipv4-addr>	IPv4 address. The IPv4 address uses the format A.B.C.D.
<ipv6-addr>	IPv6 address. The IPv6 address uses the format X:X::X:X.

Parameter	Description
<code><policy-name></code>	The local policy name. This is the name of the tunnel (e.g. tunnel2).
<code>type</code>	ISAKMP key type
<code>eap</code>	Extensible Authentication Protocol. This can be used with multipoint VPN when performing RADIUS authentication. See the GRE and Multipoint VPNs Feature Overview and Configuration Guide for more information.
<code>psk</code>	Pre-shared Key (default)

Default ISAKMP keys do not exist.

Mode Global Configuration

Usage notes Use this command to configure an authentication key for use with the ISAKMP protocol.

Before a tunnel can be protected by IPsec, each endpoint of the tunnel must verify that they are communicating with an authorized entity. ISAKMP uses authentication keys in the initial handshake between peers to ensure both endpoints are allowed to communicate.

This command specifies both the value of the key and also an identifier which is used to decide which key to use for a particular ISAKMP message exchange. Because the responding endpoint does not identify itself to the local device until after the key is used, it is important that the key identifier is part of the tunnel configuration on the initiating device.

The tunnel configuration parameter used to select which key to use when negotiating IPsec protection for that tunnel is in priority order:

- 1) **tunnel remote name**
- 2) **tunnel destination <ipv4-address>|<ipv6-address>** (if the remote name is not specified)
- 3) **tunnel local name**
- 4) **tunnel source <ipv4-address>|<ipv6-address>** (if the remote name is not specified)

For point-to-point tunnels, we recommend you configure local and remote names on the tunnels. Then use the remote name of the other device to identify the authentication keys on the local device.

For point-to-multipoint tunnels, it may be necessary to identify the authentication key by the local name of the tunnel, if the ISAKMP negotiation is to be initiated by that tunnel. This is because it is not possible to configure multiple remote names. However, it is possible to use the expected remote addresses or names of the remote initiating tunnels to identify keys. This is because the remote tunnel will identify itself when it initiates a connection.

Examples To configure a pre-shared authentication key of “friend”, using a hostname, use the commands below:

```
awplus# configure terminal
awplus(config)# crypto isakmp key friend hostname
mypeer@my.domain.com
```

To remove that pre-shared key, use the commands below:

```
awplus# configure terminal
awplus(config)# no crypto isakmp key friend hostname
mypeer@my.domain.com
```

To configure a pre-shared already-encrypted authentication key, using an IPv4 address, use the commands below:

```
awplus# configure terminal
awplus(config)# crypto isakmp key 8 Nhe6ioQmzbysQaJr6Du+cA==
address 192.168.1.2
```

To configure a pre-shared key, using the local policy “tunnel2”, use the commands:

```
awplus# configure terminal
awplus(config)# crypto isakmp key friend policy tunnel2
```

To remove that key, use the commands:

```
awplus# configure terminal
awplus(config)# no crypto isakmp key friend policy tunnel2
```

To configure an ISAKMP key using EAP, enter the commands:

```
awplus# configure terminal
awplus(config)# crypto isakmp key friend hostname example.com
type eap
```

Related commands

- [show isakmp key \(IPsec\)](#)
- [tunnel destination \(IPsec\)](#)
- [tunnel local name \(IPsec\)](#)
- [tunnel remote name \(IPsec\)](#)

Command changes

- Version 5.4.9-0.1: **type** parameter added
- Version 5.4.9-1.1: **policy** parameter added

crypto isakmp peer

Overview Use this command to configure a peer to use a specific ISAKMP profile.

Use the **no** variant to set the peer back to using the default profile.

Syntax

```
crypto isakmp peer address {<ipv4-addr>|<ipv6-addr>} profile <profile-name>
no crypto isakmp peer address {<ipv4-addr>|<ipv6-addr>} profile
crypto isakmp peer dynamic profile <profile-name>
no crypto isakmp peer dynamic profile
crypto isakmp peer hostname <hostname> profile <profile-name>
no crypto isakmp peer hostname <hostname> profile
crypto isakmp peer policy <policy-name> profile <profile-name>
no crypto isakmp peer policy <policy-name> profile
```

Parameter	Description
<ipv4-addr>	IPv4 address. The IPv4 address uses the format A.B.C.D.
<ipv6-addr>	IPv6 address. The IPv6 address uses the format X:X::X:X.
dynamic	Remote endpoint with a dynamic IP address.
<hostname>	Remote endpoint with a host name as the destination.
<policy-name>	The name of a local policy. This is the name of the tunnel (e.g. tunnel2).
<profile-name>	Profile name.

Default By default, all peers use the default profile.

Mode Global Configuration

Usage notes Use this command to configure a peer to use a specific ISAKMP profile.

When IPsec protection is applied to a tunnel, an ISAKMP profile is selected for use when IPsec parameters need to be negotiated. This profile is chosen when the tunnel first becomes active, and so must be selected based on local configuration only.

The tunnel configuration parameter used to select which ISAKMP profile to use when negotiating IPsec protection for that tunnel is in the following priority order:

- 1) **tunnel destination dynamic** (if a dynamic profile has been configured)
- 2) **tunnel endpoint dynamic** (if a dynamic profile has been configured)
- 3) **tunnel remote name**

- 4) **tunnel destination <ipv4-address>|<ipv6-address>** (if the remote name is not specified)
- 5) **tunnel endpoint <ipv4-address>**
- 6) **tunnel local name**
- 7) **tunnel source <ipv4-address>|<ipv6-address>** (if the remote name is not specified)
- 8) **tunnel destination <hostname>** (if the hostname is not specified)
- 9) **tunnel endpoint <hostname>** (if the hostname is not specified)

Examples To configure a profile for a peer, using a dynamic IP address, use the following commands:

```
awplus# configure terminal
awplus(config)# crypto isakmp peer dynamic profile peer_profile
```

To set the profile for the peer back to the default, use the following commands:

```
awplus# configure terminal
awplus(config)# no crypto isakmp peer dynamic profile
```

To configure a profile for a peer, using a local policy name of "tunnel2", use the commands:

```
awplus# configure terminal
awplus(config)# crypto isakmp peer policy tunnel2 profile
peer-profile
```

To set the profile for the peer back to the default, use the commands:

```
awplus# configure terminal
awplus(config)# no crypto isakmp peer policy tunnel2 profile
```

Related commands

- [show isakmp peer](#)
- [tunnel destination \(IPsec\)](#)
- [tunnel endpoint](#)
- [tunnel local name \(IPsec\)](#)
- [tunnel source \(IPsec\)](#)
- [tunnel remote name \(IPsec\)](#)

Command Changes

- Version 5.4.7-0.1: **hostname** parameter added.
- Version 5.4.9-1.1: **policy** parameter added.

crypto isakmp profile

Overview Use this command to configure a custom ISAKMP profile.

An ISAKMP profile comprises one or more transforms that can be configured by using the [transform \(ISAKMP Profile\)](#) command.

Use the **no** variant to delete a previously created profile.

Syntax `crypto isakmp profile <profile_name>`
`no crypto isakmp profile <profile_name>`

Parameter	Description
<code><profile_name></code>	Profile name. Profile names are case insensitive and can be up to 64 characters long composed of printable ASCII characters. Profile names can have only letters from a to z and A to Z, numbers from 0 to 9, - (dash), or _ (underscore).

Default Which ISAKMP profile transform will actually be used depends on how the negotiation between the peers is carried out when establishing the connection. For more information about default ISAKMP profiles, see the following table. Note that you cannot delete or edit the default profile. Expiry time of 24 hours applies to the default profile.

Table 71-2: ISAKMP default profile

Attribute	Encryption	Integrity	Group	Authentication
Transform 1	AES256	SHA256	14	Pre-shared
Transform 2	AES256	SHA256	16	Pre-shared
Transform 3	AES256	SHA1	14	Pre-shared
Transform 4	AES256	SHA1	16	Pre-shared
Transform 5	AES128	SHA256	14	Pre-shared
Transform 6	AES128	SHA256	16	Pre-shared
Transform 7	AES128	SHA1	14	Pre-shared
Transform 8	AES128	SHA1	16	Pre-shared
Transform 9	3DES	SHA256	14	Pre-shared
Transform 10	3DES	SHA256	16	Pre-shared
Transform 11	3DES	SHA1	14	Pre-shared
Transform 12	3DES	SHA1	16	Pre-shared

Mode Global Configuration

Examples To configure a custom ISAKMP profile for establishing ISAKMP SAs with a remote peer, use the following commands:

```
awplus# configure terminal
awplus(config)# crypto isakmp profile my_profile
awplus(config-isakmp-profile)# transform 2 integrity sha1
encryption 3des group 5
```

To delete a custom profile, use the following commands:

```
awplus# configure terminal
awplus(config)# no crypto isakmp profile my_profile
```

**Related
commands**

[dpd-interval](#)
[dpd-timeout](#)
[lifetime \(ISAKMP Profile\)](#)
[transform \(ISAKMP Profile\)](#)
[version \(ISAKMP\)](#)

**Validation
Commands**

[show isakmp profile](#)

debug isakmp

Overview Use this command to enable debugging ISAKMP.

To disable debugging ISAKMP, see [no debug isakmp](#) or [undebug isakmp](#).

Syntax debug [crypto] isakmp [info|trace|all]

Parameter	Description
debug	Debugging function.
crypto	Security specific command.
isakmp	Internet Security Association Key Management Protocol provides a common framework for key management implementations.
info	Informational debug messages such as protocol events.
trace	Verbose debug messages including protocol events and message traces.
all	All debug enabled.

Mode Privileged Exec

Examples Figure 71-1: Example output from the **debug isakmp** command on the console.

```
awplus#debug isakmp info
awplus#terminal monitor
% Warning: Console logging enabled
awplus#show ipsec peer
21:03:42 awplus IMISH[30349]: show ipsec peer

10.2.0.10
  IPSEC
    Selector: 0.0.0.0/0 0.0.0.0/0  tunnel1
    Profile: default
  ISAKMP
    LocalID: 10.1.0.10
    RemoteID: 10.2.0.10
awplus#ping 192.168.1.2

PING 192.168.1.2 (192.168.1.2) 56(84) bytes of data.
21:04:13 awplus iked: [DEBUG]: ike_pfkey.c:622:sadb_acquire_callback():
sadb_acquire_callback: seq=6 reqid=409
6 satype=96 sa_src=10.1.0.10[0] sa_dst=10.2.0.10[0] samode=229 selid=1
21:04:13 awplus iked: [DEBUG]: isakmp.c:918:isakmp_initiate(): new request (seq:6
spid:1 reqid:4096)
21:04:13 awplus iked: [DEBUG]: ikev2.c:758:ikev2_initiate(): creating new ike_sa
21:04:13 awplus iked: [DEBUG]: ike_sa.c:431:ikev2_allocate_sa():
ikev2_create_sa(nil), 10.1.0.10[500], 10.2.0
.10[500], 0x810b678)
21:04:13 awplus iked: [DEBUG]: ike_sa.c:434:ikev2_allocate_sa(): sa: 0x810d3a0
21:04:13 awplus iked: [DEBUG]: ikev2.c:800:ikev2_initiate(): child_sa: 0x810dd60
21:04:13 awplus iked: [DEBUG]: ikev2_child.c:139:ikev2_child_state_set(): child_sa
0x810dd60 state IDLING -> G
ETSPI
21:04:13 awplus iked: [DEBUG]: ike_pfkey.c:269:sadb_getspi(): sadb_getspi: seq=6,
satype=96
21:04:13 awplus iked: [DEBUG]: ike_pfkey.c:622:sadb_acquire_callback():
sadb_acquire_callback: seq=7 reqid=409
6 satype=96 sa_src=10.1.0.10[0] sa_dst=10.2.0.10[0] samode=229 selid=1
21:04:13 awplus iked: [DEBUG]: isakmp.c:918:isakmp_initiate(): new request (seq:7
spid:1 reqid:4096)
21:04:13 awplus iked: [DEBUG]: ikev2.c:800:ikev2_initiate(): child_sa: 0x810ec68
21:04:13 awplus iked: [DEBUG]: ikev2_child.c:139:ikev2_child_state_set(): child_sa
0x810ec68 state IDLING -> G
ETSPI

awplus#no debug isakmp
awplus#show debugging isakmp

ISAKMP Debugging status:
  ISAKMP Informational debugging is disabled
  ISAKMP Trace debugging is disabled
```

Related commands [no debug isakmp](#)
[undebug isakmp](#)

dpd-interval

Overview Use this command to specify the Dead Peer Detection (DPD) interval for an ISAKMP profile.

DPD is an IKE mechanism using a form of keep-alive to determine if a tunnel peer is still active.

The interval parameter specifies the amount of time the device waits for traffic from its peer before sending a DPD acknowledgment message.

Use the **no** variant to set the interval to its default (30 seconds).

Syntax `dpd-interval <10-86400>`
`no dpd-interval`

Parameter	Description
<code><10-86400></code>	Interval expressed in seconds.

Default If you do not specify an interval, the default interval of 30 seconds applies.

Mode ISAKMP Profile Configuration

Examples To specify a DPD interval, use the following commands:

```
awplus(config)# crypto isakmp profile my_profile  
awplus(config-isakmp-profile)# dpd-interval 20
```

To set the interval to its default, use the following commands:

```
awplus(config-isakmp-profile)# no dpd-interval
```

Related commands [crypto isakmp profile](#)

Validation Commands [show isakmp profile](#)

dpd-timeout

Overview Use this command to specify a Dead Peer Detection (DPD) timeout for IKEv1. DPD is an IKE mechanism using a form of keep-alive to determine if a tunnel peer is still active. DPD timeout defines the timeout interval after which all connections to a peer are deleted in case of inactivity. This only applies to IKEv1, in IKEv2 the default retransmission timeout applies as every exchange is used to detect dead peers. Use the **no** variant to set the timeout to its default (150 seconds).

Syntax `dpd-timeout <10-86400>`
`no dpd-timeout`

Parameter	Description
<code><10-86400></code>	Timeout in seconds.

Default If you do not specify a timeout, the default timeout of 150 seconds applies.

Mode ISAKMP Profile Configuration

Examples To specify a DPD timeout for IKEv1, use the following commands:

```
awplus(config)# crypto isakmp profile my_profile  
awplus(config-isakmp-profile)# dpd-timeout 200
```

To set the timeout to its default, use the following command:

```
awplus(config-isakmp-profile)# no dpd-timeout
```

Related commands [crypto isakmp profile](#)

Related commands [show isakmp profile](#)

interface tunnel (IPsec)

Overview Use this command to create a tunnel interface or to enter Interface mode to configure an existing tunnel. Tunnel interfaces are identified by an index identifier that is an integer in the range from 0 through 65535.

Use the **no** variant of this command to remove a previously created tunnel interface.

Syntax `interface tunnel<0-65535>`
`no interface tunnel<tunnel-index>`

Parameter	Description
<0-65535>	Specify a tunnel interface index identifier in the range from 0 to 65535.

Default Tunnel interfaces do not exist.

Mode Global Configuration

Usage notes After you have created the tunnel interface, use the **tunnel mode** command to enable the tunnel.

Note that you need to designate a tunnel mode, tunnel source address, tunnel destination address, IP address of tunnel interface and use [tunnel protection ipsec \(IPsec\)](#) command to encrypt and authenticate the packets travelling though the tunnel.

Examples To configure an IPsec tunnel interface with index 100, enter the commands below:

```
awplus# configure terminal
awplus(config)# interface tunnel100
awplus(config-if)# tunnel mode ipsec ipv4
```

To remove the IPsec tunnel interface tunnel100, enter the commands below:

```
awplus# configure terminal
awplus(config)# no interface tunnel100
```

Command changes Version 5.4.7-2.1: increased range for **tunnel** index identifier.

lifetime (IPsec Profile)

- Overview** Use this command to specify a lifetime for an IPsec SA.
- Lifetime measures how long the IPsec SA can be maintained before it expires. Lifetime prevents a connection from being used too long.
- Use the **no** variant to set the lifetime to default (28800 seconds).

Syntax `lifetime seconds <300-31449600>`
`no lifetime seconds`

Parameter	Description
<code><300-31449600></code>	Lifetime in seconds.

Default If you do not specify a lifetime, the default lifetime of 28800 seconds (8 hours) applies.

Mode IPsec Profile Configuration

Examples To specify a lifetime for an IPsec SA, use the following commands:

```
awplus(config)# crypto ipsec profile my_profile
awplus(config-ipsec-profile)# lifetime seconds 400
```

To set the lifetime to its default, use the following commands:

```
awplus(config)# crypto ipsec profile my_profile
awplus(config-ipsec-profile)# no lifetime seconds
```

Related commands [crypto ipsec profile](#)

lifetime (ISAKMP Profile)

Overview Use this command to specify a lifetime for an ISAKMP SA.
Lifetime measures how long the ISAKMP SA can be maintained before it expires. Lifetime prevents a connection from being used too long.
Use the **no** variant to set the lifetime to default (86400 seconds).

Syntax `lifetime <600-31449600>`
`no lifetime`

Parameter	Description
<code><600-31449600></code>	Lifetime in seconds.

Default If you do not specify a lifetime, the default lifetime of 86400 seconds (8 hours) applies.

Mode ISAKMP Profile Configuration

Examples To specify a lifetime for an ISAKMP SA, use the following commands:

```
awplus(config)# configure isakmp profile my_profile  
awplus(config-isakmp-profile)# lifetime 700
```

To set the lifetime to its default, use the following commands:

```
awplus(config-isakmp-profile)# no lifetime
```

Related commands [crypto isakmp profile](#)

no debug isakmp

Overview Use this command to disable debugging ISAKMP.
To enable debugging ISAKMP, see [debug isakmp](#).

Syntax no [crypto] isakmp [info|trace|all]

Parameter	Description
no	Disable debugging function.
crypto	Security specific.
isakmp	Internet Security Association Key Management Protocol provides a common framework for key management implementations.
info	Informational debug messages such as protocol events.
trace	Verbose debug messages including protocol events and message traces.
all	All debug enabled.

Mode Privileged Exec

Related commands [debug isakmp](#)
[undebug isakmp](#)

pfs

Overview Use this command to enable PFS and set a Diffie-Hellman group for PFS in an IPsec profile.

Use the **no** variant to disable PFS.

Syntax `pfs {2|5|14|15|16|18}`
`no pfs`

Parameter	Description
2	1024-bit MODP Group
5	1536-bit MODP Group
14	2048-bit MODP Group
15	3072-bit MODP Group
16	4096-bit MODP Group
18	8192-bit MODP Group

Default PFS is disabled.

Mode IPsec Profile Configuration

Usage notes Perfect Forward Secrecy (PFS) ensures generated keys, for example IPsec SA keys are not compromised if any other keys, for example, ISAKMP SA keys are compromised.

The specified PFS group must match the PFS group setting on the peer - especially when IKEv2 is used for ISAKMP SA negotiation. With IKEv2, if there is a PFS group mismatch an IPsec SA will be established and the tunnel will come up because PFS is not required for the initial child SA negotiation. However, when the IPsec SA rekeys it will fail due to the PFS group mismatch, and upon IPsec SA expiry the tunnel will no longer be able to carry traffic.

Examples To enable PFS and set a Diffie-Hellman group for PFS, use the following commands:

```
awplus(config)# crypto ipsec profile my_profile  
awplus(config-ipsec-profile)# pfs 15
```

To disable PFS, use the following command:

```
awplus(config-ipsec-profile)# no pfs
```

Related commands [crypto ipsec profile](#)

Validation show ipsec profile
Commands

rekey

Overview Use this command to set the rekey policy for an IPsec profile. This policy will be used to make a decision or whether the SA will rekey at its expiry.

The options are **always**, **never**, and **on-demand**. The **on-demand** option makes its decision based on whether the link has seen any traffic since the SA's last rekey.

Use the **no** variant of this command to set the rekey policy back to its default of **always**.

Syntax `rekey {always|never|on-demand}`
`no rekey`

Parameter	Description
always	Always rekey this SA (default)
never	Never rekey this SA
on-demand	Only rekey this SA if it has been used since the last rekey

Default By default, an IPsec SA will always rekey.

Mode IPsec Profile Configuration

Usage notes These options may be useful if you have a hub and spoke VPN topology and need to provision more than the maximum number of concurrent active VPNs supported by your device. **Never** and **on-demand** allow unused VPNs to be aged out, making more efficient use of the number of available VPNs.

Example To only rekey when traffic is detected over the interface, for the profile named 'myprofile', use the commands:

```
awplus# configure terminal
awplus(config)# crypto ipsec profile myprofile
awplus(config-ipsec-profile)# rekey on-demand
```

To reset the rekey policy back to its default, use the commands:

```
awplus# configure terminal
awplus(config)# crypto ipsec profile myprofile
awplus(config-ipsec-profile)# no rekey
```

Related commands [crypto ipsec profile](#)
[show ipsec profile](#)

Command changes Version 5.4.9-2.1: command added

show debugging isakmp

Overview Use this command to show if debugging ISAKMP is enabled.

Syntax show debugging [crypto] isakmp

Parameter	Description
debugging	Debugging information.
crypto	Security specific command.
isakmp	Internet Security Association Key Management Protocol provides a common framework for key management implementations.

Mode Privileged Exec

Examples To show if debugging ISAKMP is enabled, enter the command below:

```
awplus# show debugging isakmp
```

Output Figure 71-2: Example output from the **show debugging isakmp** command

```
awplus#show debugging isakmp
ISAKMP Debugging status:
  ISAKMP Informational debugging is enabled
  ISAKMP Trace debugging is disabled
```

show interface tunnel (IPsec)

Overview Use this command to display status information of tunnels.

The tunnel remains inactive if no valid tunnel source or tunnel destination is configured.

Syntax `show interface tunnel<tunnel-index>`

Parameter	Description
tunnel	Specify this parameter to display tunnel status information of a given tunnel identified by the <tunnel-index> parameter.
<tunnel-index>	Specify a tunnel index in the range from 0 through 65535.

Mode Privileged Exec

Examples To display status information for IPsec tunnel 'tunnel2', use the command:

```
awplus# show interface tunnel2
```

Output Figure 71-3: Example output from the **show interface tunnel** command

```
awplus#show interface tunnel2
Interface tunnel2
  Link is UP, administrative state is UP
  Hardware is Tunnel
  IPv4 address 192.168.1.2/30
  index 23 metric 1 mtu 1438
  <UP,RUNNING,MULTICAST>
  VRF Binding: Not bound
  SNMP link-status traps: Disabled
  Bandwidth 1g
  Tunnel source eth1 (200.1.45.1), destination 200.1.15.1
  Tunnel name local 200.1.45.1, remote 200.1.15.1
  Tunnel traffic selectors (ID, local, remote)
    1  0.0.0.0/0 0.0.0.0/0
  Tunnel protocol/transport ipsec ipv4, key disabled, sequencing disabled
  Checksumming of packets disabled, DF bit set, path MTU discovery disabled
  Tunnel protection via IPsec (profile "default")
  Tunnel inline-processing enabled
  Router Advertisement is disabled
  Router Advertisement default routes are accepted
  Router Advertisement prefix info is accepted
  input packets 0, bytes 0, dropped 0, multicast packets 0
  output packets 0, bytes 0, multicast packets 0, broadcast packets 0
  input average rate : 30 seconds 0 bps, 5 minutes 0 bps
  output average rate: 30 seconds 0 bps, 5 minutes 0 bps
  Time since last state change: 0 days 00:00:07
```

**Related
commands** [interface tunnel \(IPsec\)](#)

show ipsec counters

Overview Use this command to show IPsec counters.

Syntax show [crypto] ipsec counters

Parameter	Description
crypto	Security specific command.
ipsec	Internet Protocol Security defines the protection of IP packets using encryption and authentication.
counters	Show IPsec transformation statistic.

Mode Privileged Exec

Examples To show IPsec counters, enter the command below:

```
awplus# show ipsec counters
```

Output Figure 71-4: Example output from the **show ipsec counters** command

```
awplus#show ipsec counters
Name                               Value
-----
InError                             0
InBufferError                       0
InHdrError                           0
InNoStates                           0
InStateProtoError                   0
InStateModeError                    0
InStateSeqError                     0
InStateExpired                       0
InStateMismatch                      0
InStateInvalid                       0
InTmpMismatch                        0
InNoPols                             0
InPolBlock                           0
InPolError                           0
OutError                             0
OutBundleGenError                   0
OutBundleCheckError                 0
OutNoStates                           0
OutStateProtoError                   0
OutStateModeError                    0
OutStateSeqError                     0
OutStateExpired                       0
OutPolBlock                           0
OutPolDead                           0
OutPolError                           0
FwdHdrError                          0
```

show ipsec peer

Overview Use this command to show IPsec information on a per peer basis.

Syntax show [crypto] ipsec peer [<hostname>|<ipv4-addr>|<ipv6-addr>]

Parameter	Description
crypto	Security specific command.
peer	Remote endpoint.
<hostname>	Destination hostname.
<ipv4-addr>	Destination IPv4 address. The IPv4 address uses the format A.B.C.D.
<ipv6-addr>	Destination IPv6 address. The IPv6 address uses the format X:X::X:X.

Mode Privileged Exec

Examples To show IPsec information on a per peer basis, enter the command below:

```
awplus# show ipsec peer 172.16.0.1
```

Output Figure 71-5: Example output from the **show ipsec peer** command

```
awplus#show ipsec peer 172.16.0.1
172.16.0.2
IPsec
  Selectors (local:remote)
    Address: 0.0.0.0/0 : 0.0.0.0/0
    Protocol: any:any
    Port: any:any
    Mark: 1:1
  Profile: default
  SAs:
    SPI (In:Out): ca865389:c9c7e3d3
    Selectors: 192.168.1.0/24 : 192.168.2.0/24
    Proto: ESP
    Mode: tunnel
    Encryption: AES256
    Integrity: SHA256
    Expires: 28796s
ISAKMP
  LocalID: 172.16.0.1
  RemoteID: 172.16.0.2
  SAs:
    Cookies (Initiator:Responder) 03071749781e5992:93f8457816d3d40d
    Ver: 2 Lifetime: 84569s State: Established
    Authentication: PSK Group: 14
    Encryption: AES256 NATT: no
    Integrity: SHA256 DPD: yes
```

show ipsec policy

Overview Use this command to show IPsec policies.

Syntax `show [crypto] ipsec policy`

Parameter	Description
crypto	Security specific command.
ipsec	Internet Protocol Security defines the protection of IP packets using encryption and authentication.
policy	Policy.

Mode Privileged Exec

Examples To show IPsec policies, enter the command below:

```
awplus# show ipsec policy
```

Output Figure 71-6: Example output from the **show ipsec policy** command

```
awplus#show ipsec policy
Traffic Selector (addresses protocol ports interface)
  Profile          Peer
0.0.0.0/0 0.0.0.0/0  tunnel1
  default          10.2.0.10
```

show ipsec profile

Overview Use this command to show IPsec default and custom profiles.

An IPsec profile consists of a set of parameters that are used by IPsec when establishing IPsec SAs with a remote peer. AlliedWare Plus provides default ISAKMP and IPsec profiles that contain a priority ordered set of transforms that are considered secure by the security community.

Syntax `show [crypto] ipsec profile [<profile_name>]`

Parameter	Description
crypto	Security specific.
ipsec	Internet Protocol Security defines the protection of IP packets using encryption and authentication.
profile	An IPsec profile consists of a set of parameters that are used by IPsec SAs with a remote peer.
<profile_name>	Custom profile name.

Mode Privileged Exec

Examples To show all IPsec profiles, including the default profile, use the following command:

```
awplus# show ipsec profile
```

Output Figure 71-7: Example output from the **show ipsec profile** command

```
awplus#show ipsec profile
IPsec Profile: default
  Replay-window: 32
  Rekey: Always
  Expiry: 8h
  PFS group: disabled
  Transforms:
  Protocol Integrity Encryption
    1 ESP SHA256 AES256
    2 ESP SHA1 AES256
    3 ESP SHA256 AES128
    4 ESP SHA1 AES128
    5 ESP SHA256 3DES
    6 ESP SHA1 3DES

IPsec Profile: my_profile
  Replay-window: 32
  Rekey: On Demand
  Expiry: 8h
  PFS group: disabled
  Transforms:
  Protocol Integrity Encryption
    2 ESP SHA1 3DES
```

Examples To show IPsec profile “my_profile”, use the command:

```
awplus# show ipsec profile my_profile
```

Output Figure 71-8: Example output from the **show ipsec profile** command

```
awplus#show ipsec profile my_profile
IPsec Profile: my_profile
  Replay-window: 32
  Rekey: On Demand
  Expiry: 8h
  PFS group: disabled
  Transforms:
  Protocol Integrity Encryption
    2 ESP SHA1 3DES
```

Related commands [crypto ipsec profile](#)

show ipsec sa

Overview Use this command to view the settings used by current security associations. SAs specify the Security Parameter Index (SPI), protocols, algorithms and keys for protecting a single flow of traffic between two IPsec peers. For more information about SA, see the [Internet Protocol Security \(IPSec\) Feature Overview and Configuration Guide](#).

Syntax show [crypto] ipsec sa

Parameter	Description
crypto	Security specific command.
ipsec	Internet Protocol Security defines the protection of IP packets using encryption and authentication.
sa	Security Association.

Mode Privileged Exec

Examples To view the settings used by current security associations, enter the command below:

```
awplus# show ipsec sa
```

Output Figure 71-9: Example output from the **show ipsec sa** command

```
awplus#show ipsec sa
```

Peer	SPI (in:out) Encryption	Mode Integrity	Proto PFS	Expires
10.0.0.20	c2d8c150:7b24d3f5 AES256	tunnel SHA256	ESP -	28786s
10.0.0.22	c6c2ad0d:0d008e3d 3DES	tunnel SHA1	ESP -	3582s
10.0.0.25	cb36f9dd:cd87a834 AES128	tunnel SHA1	ESP 2	28778s

show isakmp counters

Overview Use this command to show ISAKMP counters.

Syntax show [crypto] isakmp counters

Parameter	Description
crypto	Security specific command.
isakmp	Internet Security Association Key Management Protocol provides a common framework for key management implementations.
counters	Show ISAKMP counters.

Mode Privileged Exec

Examples To show ISAKMP counters, enter the command below:

```
awplus# show isakmp counters
```

Output Figure 71-10: Example output from the **show isakmp counters** command

```
awplus#show isakmp counters
Name                               Value
-----
ikeInitRekey                        0
ikeRspRekey                         0
ikeChildSaRekey                    0
ikeInInvalid                       0
ikeInInvalidSpi                    0
ikeInInitReq                       0
ikeInInitRsp                       0
ikeOutInitReq                      0
ikeOutInitRsp                      0
ikeInAuthReq                       0
ikeInAuthRsp                       0
ikeOutAuthReq                      0
ikeOutAuthRsp                      0
ikeInCrChildReq                    0
ikeInCrChildRsp                    0
ikeOutCrChildReq                   0
ikeOutCrChildRsp                   0
ikeInInfoReq                       0
ikeInInfoRsp                       0
ikeOutInfoReq                      0
ikeOutInfoRsp                      0
```

show isakmp key (IPsec)

Overview Use this command to show ISAKMP authentication keys. These keys can be of type Pre-shared Key (PSK) or Extensible Authentication Protocol (EAP). Keys are stored encrypted in the running-configuration.

Syntax `show [crypto] isakmp key`

Parameter	Description
<code>crypto</code>	Security specific command.
<code>isakmp</code>	Internet Security Association Key Management Protocol provides a common framework for key management implementations.
<code>key</code>	Pre-shared key (PSK), or Extensible Authentication Protocol (EAP).

Mode Privileged Exec

Examples To show the ISAKMP keys, enter the command below:

```
awplus# show isakmp key
```

Output Figure 71-11: Example output from the **show isakmp key** command

```
awplus#show isakmp key
```

Hostname/IP address	PSK	EAP
10.1.1.1	mykeyone	mykeytwo
10.1.5.1	mykeyfive	-
10.1.7.1	-	mykeyseven

Related commands [crypto isakmp key](#)

show isakmp peer

Overview Use this command to show ISAKMP profile and key status for ISAKMP peers.

Syntax `show isakmp peer [<hostname>|<ipv4-addr>|<ipv6-addr>]`

Parameter	Description
<hostname>	Destination hostname.
<ipv4-addr>	Destination IPv4 address. The IPv4 address uses the format A.B.C.D.
<ipv6-addr>	Destination IPv6 address. The IPv6 address uses the format X:X::X:X.

Mode Privileged Exec

Examples To show ISAKMP profile and key status for ISAKMP peers, use the following command:

```
awplus# show isakmp peer
```

Output Figure 71-12: Example output from the **show isakmp peer** command

```
awplus#show isakmp peer
Peer                Profile (* incomplete)      Key
-----
10.1.1.1            default                    PSK, EAP
10.1.5.1            SECURE                     PSK
example.com         LEGACY                     EAP
```

Related commands [crypto isakmp peer](#)

Command changes Version 5.4.7-0.1: Parameter **hostname** added for DDNS feature.

show isakmp profile

Overview Use this command to show ISAKMP default and custom profiles.

Syntax show [crypto] isakmp profile [<profile_name>]

Parameter	Description
<profile_name>	Custom profile name.

Mode Privileged Exec

Examples To show ISAKMP profiles, including the default profile, use the command:

```
awplus# show isakmp profile
```

Output Figure 71-13: Example output from the **show isakmp profile** command

```
awplus#show isakmp profile
ISAKMP Profile: default
  Version:      IKEv2
  Authentication: PSK
  Expiry:      24h
  DPD Interval: 30s
  Transforms:
    Integrity  Encryption  DH Group
    1  SHA256   AES256    14
    2  SHA256   AES256    16
    3  SHA1     AES256    14
    4  SHA1     AES256    16
    5  SHA256   AES128    14
    6  SHA256   AES128    16
    7  SHA1     AES128    14
    8  SHA1     AES128    16
    9  SHA256   3DES     14
   10  SHA256   3DES     16
   11  SHA1     3DES     14
   12  SHA1     3DES     16

ISAKMP Profile: my_profile
  Version:      IKEv2
  Authentication: PSK
  Expiry:      24h
  DPD Interval: 30s
  Transforms:
    Integrity  Encryption  DH Group
    2  SHA1     3DES     5
```

Examples To show ISAKMP profile “my_profile”, use the command:

```
awplus# show isakmp profile my_profile
```

Output Figure 71-14: Example output from the **show isakmp profile** command

```
awplus#show isakmp profile my_profile
ISAKMP Profile: my_profile
Version:          IKEv2
Authentication:  PSK
Expiry:          24h
DPD Interval:    30s
Transforms:
  Integrity      Encryption    DH Group
  2              3DES         5
```

Related commands [crypto isakmp profile](#)

show isakmp sa

Overview Use this command to show current IKE security associations at a peer.

Syntax show [crypto] isakmp sa

Parameter	Description
crypto	Security specific command.
isakmp	Internet Security Association Key Management Protocol provides a common framework for key management implementations.
sa	Security Association.

Mode Privileged Exec

Examples To show current IKE security associations at a peer, enter the command below:

```
awplus# show isakmp sa
```

Output Figure 71-15: Example output from the **show isakmp sa** command

```
awplus#show isakmp sa
```

Peer	Cookies (initiator:responder) Encryption Integrity Group	Auth DPD	Ver NATT	Expires State
10.0.0.20	f93c2717a1ece407:972bc0c77344d7a4 AES256 SHA256 2	PSK yes	1 no	78340s Established
10.0.0.22	ccb7f90b54945375:2642525bd20f3428 3DES SHA1 2	PSK yes	1 no	3334s Established
10.0.0.25	bd0efef134c86656:d46d0b1b72b46444 AES128 SHA1 2	PSK yes	1 no	819s Established

show tunnel inline-processing counters

Overview Use this command to show the tunnel inline-processing counters.

Syntax show tunnel inline-processing counters

Mode Privileged Exec

Usage notes Global counters show packet counts (esp, frames, nsh, oam), packet decisions (decrypts, drops), and IPsec SAs tracked by tunnel inline (msg_...,sa_added, sa_deleted).

Per worker counters show the packet counts and decisions made by each worker and activity counters (fetch, sleep, wakeup,...).

Example To display tunnel inline-processing counters, use the command:

```
awplus# show tunnel inline-processing counters
```

Output Figure 71-16: Example output from **show tunnel inline-processing counters**

```
show tunnel inline-processing counters
Global Counters:
      decrypts                4913089
      drop                    0
      err_not_esp              0
      err_trans_auth           0
      err_trans_crypto         0
      esp                     4913089
      esp_error_internal       0
      esp_error_invalid_hmac   0
      esp_error_malformed     0
      esp_error_replay_fail    0
      esp_no_sa                0
      espinudp                 0
      frames                   7518246
      ignore                   2605157
      msg_del_sa               0
      msg_expired_sa           0
      msg_flush_sa             0
      msg_new_sa               0
      msg_unknown              0
      msg_updated_sa           0
      nsh                      7518246
      oam                      0
      sa_added                 2
      sa_deleted               0...
```

```
worker0: sleeping
      decrypts          1386914
      drop              0
      esp              1386914
      esp_error_internal 0
      esp_error_invalid_hmac 0
      esp_error_malformed 0
      esp_error_replay_fail 0
      esp_no_sa        0
      espinudp         0
      fetch00          617322
      fetch01          407403
      fetch02_03       155630
      fetch04_07       36150
      fetch08_15       11152
      fetch16_31       2457
      fetch32_63       2553
      fetch64_         2787
      frames           2669292
      ignore           1282378
      nsh              2669292
      oam              0
      return00         0
      return01         407403
      return02_03     155630
      return04_07     36150
      return08_15     11152
      return16_31     2457
      return32_63     2553
      return64_       2787
      sleep            617322
      sleep_cmd        617322
      sleep_user       0
      sleep_work       617322
      wakeup           617321
      wakeup_cmd       0
      wakeup_user      0
      wakeup_work      617321
```

Related commands [tunnel inline-processing](#)

Command changes Version 5.5.2-1.1: command added

transform (IPsec Profile)

Overview Use this command to create an IPsec profile transform, which specifies the encryption and authentication algorithms used to protect data.

Use the **no** variant to delete a previously created transform.

Syntax `transform <1-255> protocol esp integrity {sha1|sha256|sha512}
encryption {3des|aes128|aes192|aes256|null}`
`no transform <1-255>`

Parameter	Description
<1-255>	Transform priority (1 is the highest)
sha1	Secure Hash Standard with 160-bit digest size
sha256	Secure Hash Standard with 256-bit digest size
sha512	Secure Hash Standard with 512 bit digest size
3des	Triple DES symmetric key block cipher with a 168-bit key
aes128	Advanced Encryption Standard symmetric key block cipher with a 128-bit key
aes192	Advanced Encryption Standard symmetric key block cipher with a 192-bit key
aes256	Advanced Encryption Standard symmetric key block cipher with a 256-bit key
null	No encryption. This option is not intended for use in a live network. It should only be used for testing purposes.

Default By default, an IPsec profile has no transforms and so will not be active.

Mode IPsec Profile Configuration

Examples To configure an IPsec profile transform, use the following commands:

```
awplus(config)# crypto ipsec profile my_profile  
awplus(config-ipsec-profile)# transform 2 protocol esp  
integrity sha1 encryption 3des
```

To delete a created transform, use the following command:

```
awplus(config-ipsec-profile)# no transform 2
```

Related commands [crypto ipsec profile](#)

Validation Commands [show ipsec profile](#)

transform (ISAKMP Profile)

Overview Use this command to create an ISAKMP profile transform which specifies the encryption and authentication algorithms used to protect data in the tunnel.

Use the **no** variant to delete a previously created transform.

Syntax `transform <1-255> integrity {sha1|sha256|sha512} encryption {3des|aes128|aes192|aes256} group {2|5|14|15|16|18}`
`no transform <1-255>`

Parameter	Description
<1-255>	Transform priority (1 is the highest)
sha1	Secure Hash Standard with 160-bit digest size
sha256	Secure Hash Standard with 256-bit digest size
sha512	Secure Hash Standard with 512 bit digest size
3des	Triple DES symmetric key block cipher with a 168-bit key
aes128	Advanced Encryption Standard symmetric key block cipher with a 128-bit key
aes192	Advanced Encryption Standard symmetric key block cipher with a 192-bit key
aes256	Advanced Encryption Standard symmetric key block cipher with a 256-bit key
group	Diffie-Hellman group
2	1024-bit MODP Group
5	1536-bit MODP Group
14	2048-bit MODP Group
15	3072-bit MODP Group
16	4096-bit MODP Group
18	8192-bit MODP Group

Default By default, an ISASMP profile has no transforms and so will not be active.

Mode ISAKMP Profile Configuration

Examples To create an ISAKMP profile transform, use the following commands:

```
awplus(config)# crypto isakmp profile my_profile
awplus(config-isakmp-profile)# transform 2 integrity sha1
encryption 3des group 5
```

To delete a created transform, use the following command:

```
awplus(config-isakmp-profile)# no transform 2
```

**Related
commands** [crypto isakmp profile](#)

tunnel destination (IPsec)

Overview Use this command to specify a destination IPv4 or IPv6 address or destination network name for the remote end of the tunnel.

Use the **no** variant of this command to remove a configured tunnel destination address.

Syntax tunnel destination {<WORD>|<ipv4-address>|<ipv6-address>}
no tunnel destination {<WORD>|<ipv4-address>|<ipv6-address>}

Parameter	Description
<WORD>	Destination network name or "dynamic". The "dynamic" parameter allows you to specify a dynamic IP address for the remote endpoint. The dynamic IP address can be obtained, for example, via DHCP.
<ipv4-address>	Destination IPv4 address. The IPv4 address uses the format A.B.C.D.
<ipv6-address>	Destination IPv6 address. The IPv6 address uses the format X:X::X:X.

Mode Interface Configuration

Examples To configure a destination IPv4 address for IPsec tunnel45, use the commands:

```
awplus# configure terminal
awplus(config)# interface tunnel45
awplus(config-if)# tunnel mode ipsec ipv4
awplus(config-if)# tunnel destination 192.0.3.1
```

To configure a destination IPv6 address for IPsec tunnel45, use the commands:

```
awplus# configure terminal
awplus(config)# interface tunnel45
awplus(config-if)# tunnel mode ipsec ipv6
awplus(config-if)# tunnel destination 2001:0db8::
```

To configure a destination network name for IPsec tunnel45, use the commands:

```
awplus# configure terminal
awplus(config)# interface tunnel45
awplus(config-if)# tunnel mode ipsec ipv4
awplus(config-if)# tunnel destination www.example.com
```

To configure a dynamic IP address for the tunnel destination, use the commands:

```
awplus# configure terminal
awplus(config)# interface tunnel45
awplus(config-if)# tunnel mode ipsec ipv4
awplus(config-if)# tunnel destination dynamic
```

To remove the destination address of IPsec tunnel45, use the commands:

```
awplus# configure terminal
awplus(config)# interface tunnel45
awplus(config-if)# no tunnel destination 192.0.3.1
```

Related commands [tunnel source \(IPsec\)](#)

tunnel inline-processing

Overview Use this command to configure tunnel inline-processing for an IPsec encrypted tunnel.

Tunnel inline-processing is a faster alternative to tunnel security-reprocessing which is the alternative, less efficient option. With tunnel security-reprocessing configured, the DPI engine processes incoming VPN traffic twice (before and after decryption), in order to identify incoming application traffic transported via an encrypted VPN.

Tunnel inline-processing is useful because it means packets are decrypted before being analysed and processed via the DPI engine. This is especially important for VPN traffic, where you actually want to identify application traffic transported within the IPsec VPN, rather than the outer encrypted IPsec VPN headers.

Use the **no** variant of this command to disable tunnel inline-processing for an IPsec encrypted tunnel.

Syntax tunnel inline-processing
no tunnel inline-processing

Default Disabled

Mode Interface Configuration

Example To enable tunnel inline-processing, use the commands:

```
awplus# configure terminal
awplus(config)# interface tunnel0
awplus(config-if)# tunnel inline-processing
```

To disable tunnel inline-processing, use the commands:

```
awplus# configure terminal
awplus(config)# interface tunnel0
awplus(config-if)# no tunnel inline-processing
```

Related commands [show tunnel inline-processing counters](#)

Command changes Version 5.5.2-1.1: command added

tunnel local name (IPsec)

Overview Use this command to specify an IPsec tunnel hostname to send to the peer for authentication when you apply [tunnel protection ipsec \(IPsec\)](#) to encrypt the packets and configure an ISAKMP key.

Use the **no** variant of this command to remove a previously configured IPsec tunnel hostname.

Syntax tunnel local name *<local-name>*
no tunnel local name

Parameter	Description
<i><local-name></i>	Source tunnel hostname.

Default The default tunnel local name is the IP address of tunnel source.

Mode Interface Configuration

Examples To configure the tunnel local name office1 for tunnel6, use the commands below:

```
awplus# configure terminal
awplus(config)# interface tunnel6
awplus(config-if)# tunnel local name office1
```

To remove a configured tunnel local name for tunnel6, use the commands below:

```
awplus# configure terminal
awplus(config)# interface tunnel6
awplus(config-if)# no tunnel local name
```

Related commands [tunnel remote name \(IPsec\)](#)

tunnel local selector

Overview Use this command to specify a local subnet for a traffic selector pair.

Use the **no** variant of this command to unset the local subnet for the traffic selector pair so that it matches all sources, i.e. 0.0.0.0/0 or ::/0 for IPv4 and IPv6, respectively. When local and remote subnets for a traffic selector pair are both unset, the traffic selector pair is removed.

Syntax tunnel local selector [*<traffic-selector-ID>*]
{*<ipv4-subnet>*|*<ipv6-subnet>*}
no tunnel local selector [*<traffic-selector-ID>*]

Parameter	Description
<i><traffic-selector-ID></i>	Optional traffic selector ID from 1 through 65535. The default is 1.
<i><ipv4-subnet></i>	IPv4 subnet in the format A.B.C.D/M.
<i><ipv6-subnet></i>	IPv6 subnet in the format of X:X::X:X/M

Default When no traffic selector pairs are configured there is an implicit traffic selector pair, where the local and remote subnets are 0.0.0.0/0 or ::/0 depending on the tunnel IPsec mode.

Mode Interface configuration

Usage notes A traffic selector pair is an agreement between IKE peers to permit traffic through a tunnel if the traffic matches a specified pair of local and remote subnets. When the local selector is specified but the remote selector is not, the selector pair implicitly matches all destinations.

Examples To specify an IPv4 destination address as the traffic selector for the traffic to match for tunnel0, use the commands:

```
awplus# configure terminal
awplus(config)# interface tunnel0
awplus(config-if)# tunnel source eth1
awplus(config-if)# tunnel destination 10.0.0.2
awplus(config-if)# tunnel local name office
awplus(config-if)# tunnel mode ipsec ipv4
awplus(config-if)# tunnel local selector 192.168.1.0/24
awplus(config-if)# tunnel remote selector 192.168.2.0/24
```

To configure an additional source and destination traffic selector pair for the traffic to match for tunnel0, use the commands:

```
awplus(config-if)# tunnel local selector 5 192.168.1.0/24  
awplus(config-if)# tunnel remote selector 5 192.168.2.0/24
```

To specify an IPv6 source address as the traffic selector for the traffic to match for tunnel0, use the commands:

```
awplus# configure terminal  
awplus(config)# interface tunnel0  
awplus(config-if)# tunnel source eth1  
awplus(config-if)# tunnel destination 2001:db8:10::1  
awplus(config-if)# tunnel local name office  
awplus(config-if)# tunnel mode ipsec ipv6  
awplus(config-if)# tunnel local selector 2001:db8:1::/64  
awplus(config-if)# tunnel remote selector 2001:db8:2::/64
```

To configure an additional source and destination traffic selector pair for the traffic to match for tunnel0, use the commands:

```
awplus(config-if)# tunnel local selector 5 2001:db8:1::/64  
awplus(config-if)# tunnel remote selector 5 2001:db8:2::/64
```

To unset the destination traffic selector for the traffic selector pair with ID 1, for tunnel 6, use the commands:

```
awplus# configure terminal  
awplus(config)# interface tunnel6  
awplus(config-if)# no tunnel remote selector
```

or

```
awplus(config-if)# no tunnel remote selector 1
```

Related commands

- [tunnel remote selector](#)
- [tunnel selector paired](#)
- [show interface tunnel \(IPsec\)](#)

tunnel mode ipsec

Overview Use this command to configure the encapsulation tunneling mode to use.
Use the **no** variant of this command to remove an established tunnel.

Syntax tunnel mode ipsec {ipv4|ipv6}
no tunnel mode

Parameter	Description
ipsec ipv4	IPv4 IPsec tunnel
ipsec ipv6	IPv6 IPsec tunnel

Default Virtual tunnel interfaces have no mode set.

Mode Interface Configuration

Usage notes A tunnel will not become operational until it is configured with this command.

Examples To configure IPsec in IPv4 tunnel mode, use the commands:

```
awplus# configure terminal
awplus(config)# interface tunnel6
awplus(config-if)# tunnel mode ipsec ipv4
```

To remove the configured IPsec tunnel mode for tunnel6, use the commands:

```
awplus# configure terminal
awplus(config)# interface tunnel6
awplus(config-if)# no tunnel mode
```

tunnel oper-status-control

Overview Use this command to configure the control of operation status for point-to-point IPsec protected tunnels. This type of tunnel can be configured to use the presence or absence of an IPsec SA to determine if the interface should be considered 'UP' or 'DOWN'.

Use the **no** variant of this command to return a tunnel to the default configuration of not using the existence of an IPsec SA to set the oper-status of the tunnel.

Syntax tunnel oper-status-control {ipsec|none}
no tunnel oper-status-control

Parameter	Description
ipsec	Use the presence or absence of an IPsec SA, associated with an IPsec-protected tunnel to control the oper-status of the tunnel interface.
none	Always show the oper-status of the tunnel as 'Link is UP' and 'RUNNING'.

Default None.

Mode Interface Configuration

Usage notes By default, when a tunnel is fully configured and is administratively enabled, the tunnel always shows 'Link is UP' and the RUNNING flag is always set in the output of the **show interface** command. This is because tunnels are virtual interfaces that have no electrical state associated with them. However, this does not mean that the tunnel is capable of passing traffic.

In order to provide a kind of oper-status for point-to-point IPsec protected tunnels, the tunnel can be configured to use the presence or absence of an IPsec SA to determine if the interface should be considered 'UP' or 'DOWN', respectively. When configured in this way the device will always attempt to maintain an IPsec SA with the remote device, whereas normally one would only be established if there is traffic that needs to be passed. This is necessary, otherwise routes over the tunnel would not be considered active.

Example To use the presence of IPsec SA's to control the oper-status of interface 'tunnel1', use the commands:

```
awplus# configure terminal
awplus(config)# interface tunnel1
awplus(config-if)# tunnel oper-status-control ipsec
```

Output 1 Figure 71-17: Example output from **show interface tunnel1**

In this first example, there is an IPsec SA (i.e. IPsec has negotiated and is ready to send data) and so the link shows as 'UP'.

```
awplus#show interface tunnel1
Interface tunnel1
  Link is UP, administrative state is UP
  Hardware is Tunnel
  IPv4 address 10.1.1.1/24 point-to-point 10.1.1.255
  index 17 metric 1 mtu 1438
  UP, POINT-TO-POINT, RUNNING, MULTICAST
  SNMP link-status traps: Disabled
  Bandwidth 1g
  Tunnel source eth1 (172.16.1.1), destination 172.16.1.2
  Tunnel name local 172.16.1.1, remote 172.16.1.2
  Tunnel traffic selectors (ID, local, remote)
    1    0.0.0.0/0                0.0.0.0/0
  Tunnel protocol/transport ipsec ipv4, key disabled, sequencing disabled
  Checksumming of packets disabled, DF bit set, path MTU discovery disabled
  Tunnel protection via IPsec (profile "default")
  Router Advertisement is disabled
  Router Advertisement default routes are accepted
  Router Advertisement prefix info is accepted
    input packets 0, bytes 0, dropped 0, multicast packets
    output packets 0, bytes 0, multicast packets 0, broadcast packets 0
    input average rate : 30 seconds 0 bps, 5 minutes 0 bps
    output average rate: 30 seconds 0 bps, 5 minutes 0 bps
  Time since last state change: 0 days 00:00:49
...
```

Output 2 Figure 71-18: Example output from **show interface tunnel1**

In the second example there is no IPsec SA and so the link is 'DOWN'.

```
awplus#show interface tunnel1
Interface tunnel1
  Link is DOWN, administrative state is UP
  Hardware is Tunnel
  IPv4 address 10.1.1.1/24 point-to-point 10.1.1.255
  index 17 metric 1 mtu 1438
  UP, POINT-TO-POINT, MULTICAST
  SNMP link-status traps: Disabled
  Bandwidth 1g
  Tunnel source eth1 (172.16.1.1), destination 172.16.1.2
  Tunnel name local 172.16.1.1, remote 172.16.1.2
  Tunnel traffic selectors (ID, local, remote)
    1    0.0.0.0/0                0.0.0.0/0
  Tunnel protocol/transport ipsec ipv4, key disabled, sequencing disabled
  Checksumming of packets disabled, DF bit set, path MTU discovery disabled
  Tunnel protection via IPsec (profile "default")
  Router Advertisement is disabled
  Router Advertisement default routes are accepted
  Router Advertisement prefix info is accepted
    input packets 0, bytes 0, dropped 0, multicast packets
    output packets 0, bytes 0, multicast packets 0, broadcast packets 0
    input average rate : 30 seconds 0 bps, 5 minutes 0 bps
    output average rate: 30 seconds 0 bps, 5 minutes 0 bps
  Time since last state change: 0 days 00:00:49
...
```

Related commands [show interface](#)

Command changes Version 5.5.1-2.1: command added

tunnel protection ipsec (IPsec)

Overview Use this command to enable IPsec protection for packets encapsulated by this tunnel.

Use the **no** variant to disable IPsec protection.

Syntax tunnel protection ipsec [profile <profile_name>]
no tunnel protection ipsec

Default IPsec protection for packets encapsulated by tunnel is disabled. If no custom profile is specified, the default profile is used.

Parameter	Description
<profile_name>	Custom profile name. You can use the crypto ipsec profile command to create custom profiles.

Mode Interface Configuration

Usage notes IPsec mode tunnels (IPv4 and IPv6) require this command for them to work. GRE IPv6 and L2TPv3 IPv6 tunnel have IPsec protection as an option.

Examples To enable IPsec protection by using default profile, use the following commands:

```
awplus# configure terminal
awplus(config)# interface tunnel14
awplus(config-if)# tunnel protection ipsec
```

To enable IPsec protection by using a custom profile, use the following commands:

```
awplus(config)# interface tunnel14
awplus(config-if)# tunnel protection ipsec profile
my_profile
```

To disable IPsec protection for packets encapsulated by tunnel14, use the following commands:

```
awplus# configure terminal
awplus(config)# interface tunnel14
awplus(config-if)# no tunnel protection ipsec
```

Related commands [crypto ipsec profile](#)

tunnel remote name (IPsec)

Overview Use this command to specify a tunnel remote name to authenticate the tunnel's remote peer device when you apply [tunnel protection ipsec \(IPsec\)](#) to encrypt the packets and configure an ISAKMP key.

Use the **no** variant of this command to remove a previously configured tunnel remote name.

Syntax tunnel remote name *<remote-name>*
no tunnel local name

Parameter	Description
<i><remote-name></i>	Destination tunnel hostname

Default The default tunnel remote name is the IP address of tunnel destination.

Mode Interface Configuration

Examples To configure tunnel remote name office2 for tunnel6, use the commands below:

```
awplus# configure terminal
awplus(config)# interface tunnel6
awplus(config-if)# tunnel remote name office2
```

To remove a configured tunnel local name for tunnel6, use the commands below:

```
awplus# configure terminal
awplus(config)# interface tunnel6
awplus(config-if)# no tunnel remote name
```

Related commands [tunnel local name \(IPsec\)](#)

tunnel remote selector

Overview Use this command to specify a destination subnet for a traffic selector pair.

Use the **no** variant of this command to unset the remote subnet for a traffic selector pair so that it matches all destinations, i.e. 0.0.0.0/0 or ::/0 for IPv4 and IPv6, respectively. When local and remote subnets for a traffic selector pair are both unset, the traffic selector pair is removed.

Syntax tunnel remote selector [<traffic-selector-ID>]
{<IPv4-subnet>|<IPv6-subnet>}
no tunnel remote selector [<traffic-selector-ID>]

Parameter	Description
<traffic-selector-ID>	Traffic selector ID from 1 through 65535. If not specified the default value 1 is used.
<ipv4-subnet>	IPv4 subnet in the format A.B.C.D/M.
<ipv6-subnet>	IPv6 subnet in the format of X:X::X/M

Default When no traffic selector pairs are configured there is an implicit traffic selector pair, where the local and remote subnets are 0.0.0.0/0 or ::/0 depending on the tunnel IPsec mode.

Mode Interface configuration

Usage notes A traffic selector pair is an agreement between IKE peers to permit traffic through a tunnel if the traffic matches a specified pair of local and remote subnets. When the remote selector is specified but the local selector is not, the selector pair implicitly matches all sources.

Examples To specify an IPv4 destination address as the traffic selector for the traffic to match for tunnel0, use the commands:

```
awplus# configure terminal
awplus(config)# interface tunnel0
awplus(config-if)# tunnel source eth1
awplus(config-if)# tunnel destination 10.0.0.2
awplus(config-if)# tunnel local name office
awplus(config-if)# tunnel mode ipsec ipv4
awplus(config-if)# tunnel local selector 192.168.1.0/24
awplus(config-if)# tunnel remote selector 192.168.2.0/24
```

When no traffic selector ID is specified the default ID value is used. By specifying a traffic selector ID, additional selector pairs can be configured.

To configure an additional source and destination traffic selector pair for the traffic to match for tunnel0, use the commands:

```
awplus(config-if)# tunnel local selector 5 192.168.1.0/24  
awplus(config-if)# tunnel remote selector 5 192.168.2.0/24
```

To specify an IPv6 source address as the traffic selector for the traffic to match for tunnel0, use the commands:

```
awplus# configure terminal  
awplus(config)# interface tunnel0  
awplus(config-if)# tunnel source eth1  
awplus(config-if)# tunnel destination 2001:db8:10::1  
awplus(config-if)# tunnel local name office  
awplus(config-if)# tunnel mode ipsec ipv6  
awplus(config-if)# tunnel local selector 2001:db8:1::/64  
awplus(config-if)# tunnel remote selector 2001:db8:2::/64
```

To configure an additional source and destination traffic selector pair for the traffic to match for tunnel0, use the commands:

```
awplus(config-if)# tunnel local selector 5 2001:db8:1::/64  
awplus(config-if)# tunnel remote selector 5 2001:db8:2::/64
```

To unset the destination traffic selector for the traffic selector pair with ID 1, for tunnel6, use the commands:

```
awplus# configure terminal  
awplus(config)# interface tunnel6  
awplus(config-if)# no tunnel remote selector
```

or

```
awplus(config-if)# no tunnel remote selector 5
```

Related commands

- [tunnel local selector](#)
- [tunnel selector paired](#)
- [show interface tunnel \(IPsec\)](#)

tunnel security-reprocessing

Overview Use this command to enable stream security reprocessing on all tunnel interfaces.

Use the **no** variant of this command to disable security reprocessing on all tunnel interfaces.

Note that tunnel security reprocessing increases the load on your device and reduces throughput. This is because traffic is processed twice through the DPI engine. Therefore, it should only be enabled if your solution requires it.

Syntax tunnel security-reprocessing
no tunnel security-reprocessing

Default Security reprocessing is disabled by default.

Mode Global Configuration

Usage notes Use this command when you need to reinspect the traffic in a tunnel terminating on the device using stream UTM features after tunnel headers and encryption have been removed. For a configuration example using this command, see the [Internet Protocol Security \(IPsec\) Feature Overview and Configuration Guide](#).

Example To enable security reprocessing, use the commands:

```
awplus# configure terminal
awplus(config)# tunnel security-reprocessing
```

To disable security reprocessing, use the commands:

```
awplus# configure terminal
awplus(config)# no tunnel security-reprocessing
```

Related commands [show interface tunnel \(GRE\)](#)
[show interface tunnel \(IPsec\)](#)
[show interface tunnel \(L2TPv3\)](#)
[show interface tunnel \(OpenVPN\)](#)

Command changes Version 5.4.8-0.2: command added

tunnel selector paired

Overview Use this command when multiple selector pairs are configured. This command forces ISAKMP to use strict pairing and therefore create separate Phase 2 IPsec SAs between pairs of source and destination selectors, based on selector ID.

Use the **no** variant of this command to stop forcing strict selector ID pairing.

Syntax tunnel selector paired

Default Disabled

Mode Interface mode for a tunnel

Usage notes When this command is disabled, if you specify address selectors, the tunnel can permit any combination of matching sources and/or destinations. While this conforms to the RFC, it may not be the expected behavior and may cause the IPsec SA to either fail negotiation or fail to pass traffic correctly.

This command forces ISAKMP to create individual IPsec SAs for each pair of source and destination selectors that have the same selector ID. Only traffic that matches a selector pair is permitted to flow via the associated SA.

Example To create a tunnel between 172.16.1.0/24 and 172.16.2.0/24, and also between 172.16.1.0/24 and any other destination, use the following tunnel selector commands:

```
awplus# configure terminal
awplus(config)# interface tunnel0
awplus(config-if)# tunnel local selector 2 172.16.1.0/24
awplus(config-if)# tunnel remote selector 2 172.16.2.0/24
awplus(config-if)# tunnel local selector 3 172.16.1.0/24
awplus(config-if)# tunnel remote selector 3 0.0.0.0/0
awplus(config-if)# tunnel selector paired
```

Related commands [tunnel local selector](#)
[tunnel remote selector](#)
[show interface tunnel \(IPsec\)](#)

Command changes Version 5.4.8-1.1: command added

tunnel source (IPsec)

Overview Use this command to specify an IPv4 or IPv6 source address or interface name for packets being encapsulated in the IPsec tunnel. The source address should be an existing IPv4 address or IPv6 address or interface name configured for an interface.

Note that if the tunnel source interface has multiple IP addresses, for example, one primary and one or more secondary IP addresses, the lowest IP address on the interface is used for transporting the tunnel encapsulated traffic.

Use the **no** variant of this command to remove a tunnel source address for a tunnel interface.

Syntax tunnel source {<interface-name>|<ipv4-address>|<ipv6-address>}
no tunnel source
{<interface-name>|<ipv4-address>|<ipv6-address>}

Parameter	Description
<interface-name>	Interface name.
<ipv4-address>	The IPv4 address uses the format A.B.C.D.
<ipv6-address>	The IPv6 address uses the format X:X::X:X.

Mode Interface Configuration

Examples To configure a source IPv4 address for IPsec tunnel45, use the commands:

```
awplus# configure terminal
awplus(config)# interface tunnel45
awplus(config-if)# tunnel mode ipsec ipv4
awplus(config-if)# tunnel source 192.168.1.1
```

To configure a source IPv6 address for IPsec tunnel45, use the commands:

```
awplus# configure terminal
awplus(config)# interface tunnel45
awplus(config-if)# tunnel mode ipsec ipv6
awplus(config-if)# tunnel source 2001:db8::
```

To configure a source interface for IPsec tunnel45, use the commands:

```
awplus# configure terminal
awplus(config)# interface tunnel45
awplus(config-if)# tunnel mode ipsec ipv4
awplus(config-if)# tunnel source eth1
```

To remove the source address of IPsec tunnel45, use the commands:

```
awplus# configure terminal
awplus(config)# interface tunnel45
awplus(config-if)# no tunnel source 192.168.1.1
```

Related commands [tunnel destination \(IPsec\)](#)

undebg isakmp

Overview Use this command to disable debugging ISAKMP.
To enable debugging ISAKMP, see [debug isakmp](#).

Syntax undebg [crypto] isakmp [info|trace|all]

Parameter	Description
undebg	Disable debugging function.
crypto	Security specific command.
isakmp	Internet Security Association Key Management Protocol provides a common framework for key management implementations.
info	Informational debug messages such as protocol events.
trace	Verbose debug messages including protocol events and message traces.
all	All debug enabled.

Mode Privileged Exec

Related commands [debug isakmp](#)
[no debug isakmp](#)

version (ISAKMP)

Overview Use this command to set the ISAKMP protocol version.
Use the **no** variant to set the protocol version to default (IKEv2).

Syntax `version {1 mode {aggressive|main}|2}`
`no version`

Parameter	Description
1	IKEv1
main	IKEv1 Main mode. An IKE session begins with the initiator and recipient sending three two-way exchanges to define what encryption and authentication protocols are acceptable, how long keys should remain active, and whether perfect forward secrecy should be enforced. Main mode uses more packets for the process than Aggressive mode, but Main mode is considered more secure.
aggressive	IKEv1 Aggressive mode. The initiator and recipient accomplish the same objectives, but in only two exchanges.
2	IKEv2

Default If you do not specify the version, the default version is IKEv2

Mode IPsec ISAKMP Configuration

Examples To set the ISAKMP protocol version of profile "my_profile" to IKEv1 main mode, use the following commands:

```
awplus(config)# configure isakmp profile my_profile  
awplus(config-isakmp-profile)# version 1 mode main
```

To set the version to its default, use the following command:

```
awplus# no version
```

Related commands [crypto isakmp profile](#)

Validation Commands [show isakmp profile](#)

72

GRE Tunneling Commands

Introduction

Overview This chapter provides an alphabetical reference of commands used to configure IPv6 tunnels. For more information about IPv6 tunnels, see the [Generic Routing Encapsulation \(GRE\) Feature Overview and Configuration Guide](#).

- Command List**
- “[interface tunnel \(GRE\)](#)” on page 3690
 - “[local authentication](#)” on page 3691
 - “[remote authentication](#)” on page 3693
 - “[show interface tunnel \(GRE\)](#)” on page 3695
 - “[tunnel checksum](#)” on page 3696
 - “[tunnel dscp](#)” on page 3697
 - “[tunnel destination \(GRE\)](#)” on page 3698
 - “[tunnel endpoint](#)” on page 3700
 - “[tunnel local name \(GRE\)](#)” on page 3702
 - “[tunnel mode gre](#)” on page 3703
 - “[tunnel mode gre multipoint](#)” on page 3704
 - “[tunnel protection ipsec \(GRE\)](#)” on page 3705
 - “[tunnel remote name \(GRE\)](#)” on page 3706
 - “[tunnel security-reprocessing](#)” on page 3707
 - “[tunnel source \(GRE\)](#)” on page 3708
 - “[tunnel ttl](#)” on page 3710

interface tunnel (GRE)

Overview Use this command to create a tunnel interface or to enter Interface mode to configure an existing tunnel. Tunnel interfaces are identified by an index identifier that is an integer in the range from 0 through 65535.

Use the **no** variant of this command to remove a previously created tunnel interface.

Syntax `interface tunnel<0-65535>`
`no interface tunnel<tunnel-index>`

Parameter	Description
<code><0-65535></code>	Specify a tunnel interface index identifier in the range from 0 through 65535.

Default Tunnel interfaces do not exist.

Mode Global Configuration

Usage notes After you have created the tunnel interface, use the **tunnel mode** command to enable the tunnel.

Examples To configure a tunnel interface with index 30 and enable GRE, use the commands:

```
awplus# configure terminal
awplus(config)# interface tunnel30
awplus(config-if)# tunnel mode gre
```

To remove the GRE tunnel interface tunnel30, use the commands:

```
awplus# configure terminal
awplus(config)# no interface tunnel30
```

Command changes Version 5.4.7-2.1: increased range for **tunnel** index identifiers.

local authentication

Overview Use this command to specify the authentication method for the local device for a GRE Multipoint tunnel.

Use the **no** variant of this command to set the local authentication for an ISAKMP profile back to the default pre-shared.

Syntax `local authentication [pre-shared|eap-radius]`
`no local authentication`

Parameter	Description
pre-shared	Authenticate using pre-shared keys (default)
eap-radius	Authenticate using a radius server

Default Pre-shared

Mode ISAKMP Profile configuration

Usage notes This command allows you to choose between pre-shared, where a fixed key is known by both ends and eap-radius, where a key is stored on a radius server.

- Local authentication can be reset back to pre-shared (the default) for the device to authenticate using pre-shared keys.
- Local authentication can be set to eap-radius for the device to authenticate using a radius server.

Examples To configure local authentication for an ISAKMP profile, use the commands:

```
awplus# configure terminal
awplus(config)# configure isakmp profile my_profile
awplus(config-isakmp-profile)# local authentication eap-radius
```

To set the local authentication for an ISAKMP profile back to the default (pre-shared), use the commands:

```
awplus# configure terminal
awplus(config)# configure isakmp profile my_profile
awplus(config-isakmp-profile)# no local authentication
```

Related commands

- [remote authentication](#)
- [show interface tunnel \(GRE\)](#)
- [show isakmp profile](#)
- [tunnel endpoint](#)
- [tunnel mode gre multipoint](#)

Command changes Version 5.4.9-0.1: command added

remote authentication

Overview Use this command to specify the authentication method for the remote device for a GRE Multipoint tunnel.

Use the **no** variant of this command to set the remote authentication back to the default (pre-shared).

Syntax `remote authentication [pre-shared|eap-radius]`
`no remote authentication`

Parameter	Description
pre-shared	Authenticate using pre-shared keys (default)
eap-radius	Authenticate using a radius server

Default Pre-shared

Mode ISAKMP profile configuration

Usage notes This command allows you to choose between pre-shared, where a fixed key is known by both ends and eap-radius, where a key is stored on a radius server.

- Remote authentication can be reset back to pre-shared (the default) for the device to authenticate using pre-shared keys.
- Remote authentication can be set to eap-radius for the device to authenticate using a radius server.

Examples To configure remote authentication for an ISAKMP profile, use the following commands:

```
awplus# configure terminal
awplus(config)# configure isakmp profile my_profile
awplus(config-isakmp-profile)# remote authentication
eap-radius
```

To configure remote authentication for an ISAKMP profile back to the default (pre-shared), use the following commands:

```
awplus# configure terminal
awplus(config)# configure isakmp profile my_profile
awplus(config-isakmp-profile)# no remote authentication
```

Related commands [local authentication](#)

[show interface tunnel \(GRE\)](#)

[show isakmp profile](#)

[tunnel endpoint](#)

tunnel mode gre multipoint

Command changes Version 5.4.9-0.1: command added

show interface tunnel (GRE)

Overview Use this command to display status information of tunnels.

The tunnel remains inactive if no valid tunnel source or tunnel destination is configured.

Syntax `show interface tunnel<tunnel-index>`

Parameter	Description
tunnel	Specify this parameter to display tunnel status information of a given tunnel identified by the <0-65535> parameter.
<0-65535>	Specify a tunnel index in the range from 0 through 65535.

Mode Privileged Exec

Example To display status information for GRE tunnel tunnel20, use the command:

```
awplus# show interface tunnel20
```

Figure 72-1: Example output from the **show interface tunnel** command

```
awplus#show interface tunnel20
Interface tunnel20
  Link is UP, administrative state is UP
  Hardware is Tunnel
  IPv4 address 172.16.1.1/24 pointopoint 172.16.1.255
  index 4750 metric 1 mtu 1480
  arp ageing timeout 300
  <UP,POINTOPOINT,RUNNING,MULTICAST>
  SNMP link-status traps: Disabled
  Tunnel source 192.168.1.1, destination 192.168.2.1
  Tunnel local 192.168.1.1, remote 192.168.2.1
  Tunnel protocol/transport gre, key disabled, sequencing disabled
  Tunnel TTL inherit
  Checksumming of packets disabled, path MTU discovery disabled
    input packets 0, bytes 0, dropped 0, multicast packets 0
    output packets 0, bytes 0, multicast packets 0 broadcast
  packets 0
  Time since last state change: 0 days 00:05:25
```

tunnel checksum

Overview Use this command to enable GRE tunnel checksum insertion and checking. This results in the first two bytes after the protocol field in the IPv4 header containing the checksum. The tunnel checksum is used to detect packet corruption.

Use the **no** variant of this command to disable checksum insertion and checking.

Syntax tunnel checksum
no tunnel checksum

Default Checksum insertion and checking is disabled.

Mode Interface Configuration

Examples To enable checksum insertion and checking, use the commands:

```
awplus# configure terminal
awplus(config)# interface tunnel2
awplus(config-if)# tunnel mode gre
awplus(config-if)# tunnel checksum
```

To disable checksum insertion and checking, use the commands:

```
awplus# configure terminal
awplus(config)# interface tunnel2
awplus(config-if)# no tunnel checksum
```

tunnel dscp

Overview Use this command to configure the Differentiated Services Code Point (DSCP) value for the DSCP field in the packet header that encapsulates the tunneled packets.

Use the **no** variant of this command to reset the DSCP field to its default value.

Syntax tunnel dscp <0-63>
no tunnel dscp

Parameter	Description
<0-63>	Specify the DSCP value in the range from 0 through 63 for the DSCP field in the packet header that encapsulates the tunneled packets.

Default The IPv4 DSCP field value is inherited from the inner header to the outer header.

Mode Interface Configuration

Examples To configure the DSCP value to 10 for tunnel2, use the commands:

```
awplus# configure terminal
awplus(config)# interface tunnel2
awplus(config-if)# tunnel dscp 10
```

To remove a configured DSCP value for tunnel2, use the commands:

```
awplus# configure terminal
awplus(config)# interface tunnel2
awplus(config-if)# no tunnel dscp
```

Related commands [interface tunnel \(IPv6\)](#)
[interface tunnel \(GRE\)](#)

tunnel destination (GRE)

Overview Use this command to specify a tunnel destination for the remote end of the tunnel. Tunnel destination can be specified by using a destination network name or an IPv4 address.

Use the **no** variant of this command to remove a configured tunnel destination.

Syntax tunnel destination {<ipv4-addr>|<destination-network-name>}
no tunnel destination

Parameter	Description
<ipv4-addr>	Specify the tunnel destination IPv4 address in the dotted decimal format A.B.C.D. The endpoints of the tunnel must be configured by mirroring IP addresses, that is, the tunnel source on one endpoint must be specified as the tunnel destination on the other endpoint.
<destination-network-name>	Destination network name. If the destination network name cannot be resolved, then the GRE tunnel remains inactive.

Mode Interface Configuration

Examples To configure an IPv4 tunnel destination by using an IPv4 address, use the commands:

```
awplus# configure terminal
awplus(config)# interface tunnel40
awplus(config-if)# tunnel mode gre
awplus(config-if)# tunnel destination 2.2.2.2
```

To configure a GRE tunnel destination by using a destination network name, use the commands:

```
awplus# configure terminal
awplus(config)# interface tunnel40
awplus(config-if)# tunnel mode gre
awplus(config-if)# tunnel destination
corporate_lan.example.com
```

To remove a GRE tunnel destination, use the commands:

```
awplus# configure terminal
awplus(config)# interface tunnel40
awplus(config-if)# no tunnel destination
```

**Related
commands** interface tunnel (GRE)
tunnel mode gre
tunnel source (GRE)

tunnel endpoint

Overview Use this command to set an endpoint to a GRE Multipoint tunnel interface.
Use the **no** variant of this command to remove an existing configured endpoint.

Syntax tunnel endpoint {<ipv4-addr>|<network-name>|dynamic}
no tunnel endpoint {<ipv4-addr>|<network-name>|dynamic}

Parameter	Description
<ipv4-address>	Specify the tunnel endpoint IPv4 address in the dotted decimal format A.B.C.D.
<network-name>	Specify the endpoint network name.
dynamic	Dynamically learn tunnel endpoints.

Default Virtual tunnel interfaces have no endpoints set.

Mode Interface Configuration

Examples To configure an IPv4 tunnel endpoint for tunnel6, use the commands:

```
awplus# configure terminal
awplus(config)# interface tunnel6
awplus(config-if)# tunnel endpoint 192.168.100.1
```

To remove the IPv4 tunnel endpoint for tunnel6, use the commands:

```
awplus# configure terminal
awplus(config)# interface tunnel6
awplus(config-if)# no tunnel endpoint 192.168.100.1
```

To configure a tunnel endpoint network name "example_lan.com" for tunnel6, use the commands:

```
awplus# configure terminal
awplus(config)# interface tunnel6
awplus(config-if)# tunnel endpoint example_lan.com
```

To remove the tunnel endpoint network name "example_lan.com" for tunnel6, use the commands:

```
awplus# configure terminal
awplus(config)# interface tunnel6
awplus(config-if)# tunnel endpoint example_lan.com
```

To configure a dynamic tunnel endpoint for tunnel6, use the commands:

```
awplus# configure terminal
awplus(config)# interface tunnel6
awplus(config-if)# tunnel endpoint dynamic
```

To remove the dynamic tunnel endpoint for tunnel6, use the commands:

```
awplus# configure terminal
awplus(config)# interface tunnel6
awplus(config-if)# no tunnel endpoint dynamic
```

**Related
commands**

[local authentication](#)
[remote authentication](#)
[show interface tunnel \(GRE\)](#)
[tunnel mode gre multipoint](#)

**Command
changes**

Version 5.4.9-0.1: command added

tunnel local name (GRE)

Overview Use this command to specify an IPsec tunnel hostname to send to the peer for authentication when you apply [tunnel protection ipsec \(GRE\)](#) to encrypt the packets and configure an ISAKMP key.

Use the **no** variant of this command to remove a previously configured IPsec tunnel hostname.

Syntax tunnel local name *<local-name>*
no tunnel local name

Parameter	Description
<i><local-name></i>	Source tunnel hostname.

Default The default tunnel local name is the IP address of tunnel source.

Mode Interface Configuration

Examples To configure the tunnel local name office1 for tunnel6, use the commands below:

```
awplus# configure terminal
awplus(config)# interface tunnel6
awplus(config-if)# tunnel local name office1
```

To remove a configured tunnel local name for tunnel6, use the commands below:

```
awplus# configure terminal
awplus(config)# interface tunnel6
awplus(config-if)# no tunnel local name
```

Related commands [tunnel remote name \(GRE\)](#)

tunnel mode gre

Overview Use this command to configure the encapsulation tunneling mode to use. This command sets GRE IPv4 or IPv6 as the payload over IPv4 or IPv6 tunneling.

Use the **no** variant of this command to remove an established tunnel.

Syntax `tunnel mode gre [ipv6]`
`no tunnel mode`

Parameter	Description
<code>gre ipv6</code>	Specify GRE IPv4 or IPv6 as the payload over IPv6 tunneling. IPv6 is the delivery protocol.

Default Virtual tunnel interfaces have no mode set by default. If you specify a mode of **gre**, the delivery protocol is IPv4 unless you specify IPv6.

Mode Interface Configuration

Usage notes A tunnel will not become operational until it is configured with this command.

Examples To configure GRE as the encapsulation mode for tunnel2, use the commands:

```
awplus# configure terminal
awplus(config)# interface tunnel2
awplus(config-if)# tunnel mode gre
```

To remove a configured GRE tunnel mode for tunnel2, use the commands:

```
awplus# configure terminal
awplus(config)# interface tunnel2
awplus(config-if)# no tunnel mode
```

Related commands [interface tunnel \(GRE\)](#)

tunnel mode gre multipoint

Overview Use this command to set the tunnel mode to GRE Multipoint.
Use the **no** variant of this command to unconfigure this tunnel mode.

Syntax tunnel mode gre multipoint
no tunnel mode

Default Virtual tunnel interfaces have no mode set.

Mode Interface Configuration

Examples To configure gre multipoint tunnel mode for tunnel6, use the commands:

```
awplus# configure terminal
awplus(config)# interface tunnel6
awplus(config-if)# tunnel mode gre multipoint
```

To remove the configured gre multipoint tunnel mode for tunnel6, use the commands:

```
awplus# configure terminal
awplus(config)# interface tunnel6
awplus(config-if)# no tunnel mode
```

Related commands [aaa authentication isakmp](#)
[crypto isakmp key](#)
[local authentication](#)
[remote authentication](#)
[show interface tunnel \(GRE\)](#)
[tunnel endpoint](#)

Command changes Version 5.4.9-0.1: command added

tunnel protection ipsec (GRE)

Overview Use this command to optionally enable IPsec protection for packets encapsulated by this tunnel.

Use the **no** variant to disable IPsec protection.

Syntax `tunnel protection ipsec [profile <ipsec-profile>]`
`no tunnel protection ipsec`

Parameter	Description
<ipsec-profile>	The name of an optional custom IPsec profile (crypto ipsec profile command) to use to protect this tunnel.

Default IPsec protection for packets encapsulated by tunnel is disabled.

Mode Interface Configuration

Usage notes You also need to configure a pre-shared key in conjunction with this command. See the [crypto isakmp key](#) command for more information about configuring the pre-shared key.

Examples To enable IPsec protection for packets encapsulated by `tunnel14`, use the commands below:

```
awplus# configure terminal
awplus(config)# interface tunnel14
awplus(config-if)# tunnel protection ipsec
```

To disable IPsec protection for packets encapsulated by `tunnel14`, use the commands below:

```
awplus# configure terminal
awplus(config)# interface tunnel14
awplus(config-if)# no tunnel protection ipsec
```

Related commands [crypto ipsec profile](#)
[crypto isakmp key](#)
[show isakmp key \(IPsec\)](#)

tunnel remote name (GRE)

Overview Use this command to specify a tunnel remote name to authenticate the tunnel's remote peer device when you apply [tunnel protection ipsec \(GRE\)](#) to encrypt the packets and configure an ISAKMP key.

Use the **no** variant of this command to remove a previously configured tunnel remote name.

Syntax `tunnel remote name <remote-name>`
`no tunnel local name`

Parameter	Description
<code><remote-name></code>	Destination tunnel hostname

Default The default tunnel remote name is the IP address of tunnel destination.

Mode Interface Configuration

Examples To configure tunnel remote name `office2` for `tunnel6`, use the commands below:

```
awplus# configure terminal
awplus(config)# interface tunnel6
awplus(config-if)# tunnel remote name office2
```

To remove a configured tunnel local name for `tunnel6`, use the commands below:

```
awplus# configure terminal
awplus(config)# interface tunnel6
awplus(config-if)# no tunnel remote name
```

Related commands [tunnel local name \(GRE\)](#)

tunnel security-reprocessing

Overview Use this command to enable stream security reprocessing on all tunnel interfaces.

Use the **no** variant of this command to disable security reprocessing on all tunnel interfaces.

Note that tunnel security reprocessing increases the load on your device and reduces throughput. This is because traffic is processed twice through the DPI engine. Therefore, it should only be enabled if your solution requires it.

Syntax tunnel security-reprocessing
no tunnel security-reprocessing

Default Security reprocessing is disabled by default.

Mode Global Configuration

Usage notes Use this command when you need to reinspect the traffic in a tunnel terminating on the device using stream UTM features after tunnel headers and encryption have been removed. For a configuration example using this command, see the [Internet Protocol Security \(IPsec\) Feature Overview and Configuration Guide](#).

Example To enable security reprocessing, use the commands:

```
awplus# configure terminal  
awplus(config)# tunnel security-reprocessing
```

To disable security reprocessing, use the commands:

```
awplus# configure terminal  
awplus(config)# no tunnel security-reprocessing
```

Related commands [show interface tunnel \(GRE\)](#)
[show interface tunnel \(IPsec\)](#)
[show interface tunnel \(L2TPv3\)](#)
[show interface tunnel \(OpenVPN\)](#)

Command changes Version 5.4.8-0.2: command added

tunnel source (GRE)

Overview Use this command to specify a tunnel source for the tunnel interface. Tunnel source can be specified by using an interface name or an IPv4 address. The source address must be an existing IPv4 address configured for an interface.

Use the **no** variant of this command to remove a tunnel source for a tunnel interface.

Syntax tunnel source {<ipv4-addr>|<interface-name>}
no tunnel source

Parameter	Description
<ipv4-addr>	Specify the tunnel source IPv4 address for the GRE tunnel interface in the dotted decimal format A.B.C.D. The endpoints of the tunnel must be configured by mirroring IP addresses, that is, the tunnel source on one endpoint must be specified as the tunnel destination on the other endpoint.
<interface-name>	Available interface name. Any AlliedWare Plus interface type (eth, vlan, ppp, tunnel, lo, etc). Using interface name can minimize the number of user-configured IP addresses and allow the tunnel source IP address to be dynamically issued via, for example, DHCP.

Mode Interface Configuration

Examples To configure a GRE tunnel source IPv4 address, use the commands:

```
awplus# configure terminal
awplus# interface eth1
awplus(config-if)# ip address 1.1.1.1/24
awplus(config-if)# interface tunnel1
awplus(config-if)# tunnel mode gre
awplus(config-if)# tunnel source 1.1.1.1
```

To use an interface name as the tunnel source, use the commands:

```
awplus# configure terminal
awplus(config)# interface tunnel2
awplus(config-if)# tunnel mode gre
awplus(config-if)# tunnel source eth2
```

To remove a GRE tunnel source, use the commands:

```
awplus# configure terminal
awplus(config)# interface tunnel1
awplus(config-if)# no tunnel source
```

Related commands interface tunnel (GRE)
tunnel destination (GRE)
tunnel mode gre

tunnel ttl

Overview Use this command to configure the value to use for the Time to Live (TTL) field in the IPv4 header that encapsulates the tunneled IPv4 or IPv6 packets.

Use the **no** variant of this command to set the TTL value to its default.

Syntax tunnel ttl <1-255>
no tunnel ttl

Parameter	Description
<1-255>	TTL value from 1 through 255.

Default The default TTL value is inherited from the encapsulated packet.

Mode Interface Configuration

Example To set the TTL value of the packet to 255, use the commands:

```
awplus# configure terminal
awplus(config)# interface tunnel120
awplus(config-if)# tunnel ttl 255
```

To remove the configured TTL value of the packet, use the commands:

```
awplus# configure terminal
awplus(config)# interface tunnel120
awplus(config-if)# no tunnel ttl
```

Related commands [interface tunnel \(IPv6\)](#)
[interface tunnel \(GRE\)](#)

73

OpenVPN Commands

Introduction

This chapter provides an alphabetical reference of commands used to configure AlliedWare Plus OpenVPN.

For introductory information about AlliedWare Plus OpenVPN, including overview and configuration information, see the [OpenVPN Feature Overview and Configuration_Guide](#).

The table below lists the OpenVPN commands and their applicable modes.

Figure 73-1: OpenVPN commands and applicable modes

Mode	Command
Privileged Exec	<code>show openvpn connections</code>
	<code>show openvpn connections detail</code>
Interface Configuration	<code>tunnel mode openvpn tap</code>
	<code>tunnel mode openvpn tun</code>
	<code>tunnel openvpn port</code>
	<code>tunnel openvpn tagging</code>

- Command List**
- `"ip tcp adjust-mss"` on page 3713
 - `"ipv6 tcp adjust-mss"` on page 3715
 - `"show interface tunnel (OpenVPN)"` on page 3717
 - `"show openvpn connections"` on page 3718
 - `"show openvpn connections detail"` on page 3719
 - `"tunnel openvpn tls-version-min"` on page 3720
 - `"tunnel openvpn authentication"` on page 3721

- [“tunnel openvpn cipher”](#) on page 3722
- [“tunnel mode openvpn tap”](#) on page 3724
- [“tunnel mode openvpn tun”](#) on page 3725
- [“tunnel openvpn expiry-bytes”](#) on page 3726
- [“tunnel openvpn expiry-seconds”](#) on page 3727
- [“tunnel openvpn port”](#) on page 3728
- [“tunnel openvpn tagging”](#) on page 3729
- [“tunnel openvpn tls-crypt”](#) on page 3730
- [“tunnel security-reprocessing”](#) on page 3731

ip tcp adjust-mss

Overview Use this command to set the Maximum Segment Size (MSS) size for an interface, where MSS is the maximum TCP data packet size that the interface can transmit before fragmentation.

Use the **no** variant of this command to remove a previously specified MSS size for a PPP interface, and restore the default MSS size.

Syntax `ip tcp adjust-mss {<mss-size>|pmtu}`
`no ip tcp adjust-mss`

Parameter	Description
<code><mss-size></code>	<code><64-1460></code> Specifies the MSS size in bytes.
<code>pmtu</code>	Adjust TCP MSS automatically with respect to the MTU on the interface.

Default The default setting allows a TCP server or a TCP client to set the MSS value for itself.

Mode Interface Configuration

Usage notes When a host initiates a TCP session with a server it negotiates the IP segment size by using the MSS option field in the TCP packet. The value of the MSS option field is determined by the Maximum Transmission Unit (MTU) configuration on the host.

You can set a feasible MSS value on the following interfaces:

- PPP
- Ethernet
- Tunnel
- VLAN

Examples To configure an MSS size of 1452 bytes on PPP interface ppp0, use the commands:

```
awplus# configure terminal
awplus(config)# interface ppp0
awplus(config-if)# ip tcp adjust-mss 1452
```

To configure an MSS size of 1452 bytes on Ethernet interface eth1, use the commands:

```
awplus# configure terminal
awplus(config)# interface eth1
awplus(config-if)# ip tcp adjust-mss 1452
```

To configure an MSS size of 1452 bytes on interface tunnel2, use the commands:

```
awplus# configure terminal
awplus(config)# interface tunnel2
awplus(config-if)# ip tcp adjust-mss 1452
```

To restore the MSS size to the default size on PPP interface ppp0, use the commands:

```
awplus# configure terminal
awplus(config)# interface ppp0
awplus(config-if)# no ip tcp adjust-mss
```

**Related
commands**

[mtu \(PPP\)](#)
[show interface](#)
[show interface \(PPP\)](#)
[show interface tunnel \(GRE\)](#)

**Command
changes**

Version 5.4.8-2.1: interface tunnel example added

ipv6 tcp adjust-mss

Overview Use this command to set the IPv6 Maximum Segment Size (MSS) size for an interface, where MSS is the maximum TCP data packet size that the interface can transmit before fragmentation.

Use the **no** variant of this command to remove a previously specified MSS size for a PPP interface, and restore the default MSS size.

Syntax `ipv6 tcp adjust-mss {<mss-size>|pmtu}`
`no ipv6 tcp adjust-mss`

Parameter	Description
<code><mss-size></code>	<code><64-1460></code> Specifies the MSS size in bytes.
<code>pmtu</code>	Adjust TCP MSS automatically with respect to the MTU on the interface.

Default The default setting allows a TCP server or a TCP client to set the MSS value for itself.

Mode Interface Configuration

Usage notes When a host initiates a TCP session with a server it negotiates the IP segment size by using the MSS option field in the TCP packet. The value of the MSS option field is determined by the Maximum Transmission Unit (MTU) configuration on the host.

You can set a feasible MSS value on the following interfaces:

- PPP
- Ethernet
- Tunnel
- VLAN

Examples To configure an IPv6 MSS size of 1452 bytes on PPP interface ppp0, use the commands:

```
awplus# configure terminal
awplus(config)# interface ppp0
awplus(config-if)# ipv6 tcp adjust-mss 1452
```

To configure an IPv6 MSS size of 1452 bytes on Ethernet interface eth1, use the commands:

```
awplus# configure terminal
awplus(config)# interface eth1
awplus(config-if)# ipv6 tcp adjust-mss 1452
```

To adjust IPv6 TCP MSS automatically with respect to the MTU on interface tunnel2, use the commands:

```
awplus# configure terminal
awplus(config)# interface tunnel2
awplus(config-if)# ipv6 tcp adjust-mss pmtu
```

To restore the MSS size to the default size on PPP interface ppp0, use the commands:

```
awplus# configure terminal
awplus(config)# interface ppp0
awplus(config-if)# no ipv6 tcp adjust-mss
```

**Related
commands**

[mtu \(PPP\)](#)
[show interface](#)
[show interface \(PPP\)](#)
[show interface tunnel \(GRE\)](#)

**Command
changes**

Version 5.4.8-2.1: interface tunnel example added

show interface tunnel (OpenVPN)

Overview Use this command to display status information of a tunnel.
The tunnel remains inactive if no valid tunnel source or tunnel destination is configured.

Syntax `show interface tunnel<tunnel-index>`

Parameter	Description
<code><tunnel-index></code>	The tunnel index in the range from 0 to 65535.

Mode Privileged Exec

Examples To display brief status information for OpenVPN tunnel0, enter the command below:

```
awplus# show interface tunnel0
```

Output Figure 73-2: Example output from the **show interface tunnel** command

```
awplus#show interface tunnel0
Interface tunnel0
  Link is UP, administrative state is UP
  Hardware is Tunnel
  IPv4 address 10.8.1.2/24 broadcast 10.8.1.255
  IPv6 address fc00:5::2/64
  IPv6 address fe80::5054:98ff:fe43:428e/64
  index 22 metric 1 mtu 1405
  <UP,BROADCAST,RUNNING,MULTICAST>
  SNMP link-status traps: Disabled
  Bandwidth 1g
  Tunnel protocol/transport openvpn tap, listen port 1194
  cipher aes128, authentication sha1
  expiry-kbytes 0, expiry-seconds 3600
  tls-version-min 1.0
  Checksumming of packets disabled, DF bit set, path MTU discovery disabled
  Router Advertisement is disabled
  Router Advertisement default routes are accepted
  Router Advertisement prefix info is accepted
  input packets 0, bytes 0, dropped 0, multicast packets 0
  output packets 6, bytes 452, multicast packets 0, broadcast packets 0
  input average rate : 30 seconds 0 bps, 5 minutes 0 bps
  output average rate: 30 seconds 73 bps, 5 minutes 11 bps
  output peak rate 482 bps at 2021/03/08 01:29:01
  Time since last state change: 0 days 00:00:41
```

Command changes Version 5.5.0-2.1: command added to AR1050V

show openvpn connections

Overview Use this command to show information about connected OpenVPN users.

Syntax show openvpn connections

Mode Privileged Exec

Examples To show information about connected OpenVPN users, use the command:

```
awplus# show openvpn connections
```

Output Figure 73-3: Example output from the **show openvpn connections** command

```
awplus#show openvpn connections

Maximum connections: 100

Interface: tunnel0

Username      Real Address      Rx      Tx
              Bytes      Bytes      Connected Since
-----
foo           ::ffff:192.168.1.2  3553    3906    Wed Aug 13 01:09:07 2014
```

Related commands [show openvpn connections detail](#)

Command changes Version 5.5.0-2.1: command added to AR1050V

show openvpn connections detail

Overview Use this command to show detailed information about connected OpenVPN users.

Note that in the output, parameters (such as Route, Address, DNS Server) for a specific user may vary because the parameters depend on the configuration information of the RADIUS server associated with the user.

Syntax `show openvpn connections detail`

Mode Privileged Exec

Examples To show detailed information about connected OpenVPN users, use the command:

```
awplus# show openvpn connections detail
```

Output Figure 73-4: Example output from the **show openvpn connections detail** command

```
awplus#show openvpn connections detail

Interface: tunnel0
Username: user1
Route:      192.168.20.0 255.255.255.0 192.168.10.2
Address:    192.168.10.3 255.255.255.0
DNS Server: 192.168.10.253
DNS Server: 192.168.10.254
VID:       20
Username: user2
Route:      192.168.20.0 255.255.255.0 192.168.10.2
Address:    192.168.10.4 255.255.255.0
DNS Server: 192.168.10.253
DNS Server: 192.168.10.254
VID:       20
```

Related commands [show openvpn connections](#)

Command changes Version 5.5.0-2.1: command added to AR1050V

tunnel openvpn tls-version-min

Overview Use this command to set the minimum TLS (Transport Layer Security) version allowed for OpenVPN.

Use the **no** variant of this command to revert to the default TLS version (1.0).

Syntax tunnel openvpn tls-version-min {1.1|1.2|1.3}
no tunnel openvpn tls-version-min

Parameter	Description
tls-version-min	Enter the minimum TLS version: 1.1, 1.2, or 1.3. If the command is never entered, or the 'no' version is configured, then the default version 1.0 is used.

Default 1.0

Mode Interface Configuration

Example To set the minimum TLS version as 1.1 on Open VPN tunnel1, use the commands:

```
awplus# configure terminal
awplus(config)# interface tunnel1
awplus(config-if)# tunnel openvpn tls-version-min 1.1
```

Related commands [tunnel openvpn cipher](#)
[tunnel openvpn expiry-bytes](#)

Command changes Version 5.5.1-2.1: TLS version 1.3 added
Version 5.5.1-0.1: command added

tunnel openvpn authentication

Overview Use this command to configure the data channel authentication digest for an OpenVPN tunnel.

Use the **no** variant of this command to set the data channel authentication digest for an OpenVPN tunnel to its default value of SHA1.

Syntax tunnel openvpn authentication {sha1|sha256}
no tunnel openvpn authentication

Parameter	Description
sha1	Use Secure Hash Standard with 160-bit digest size as the data channel authentication digest.
sha256	Use Secure Hash Standard with 256-bit digest size as the data channel authentication digest.

Default SHA1

Mode Interface configuration

Usage notes You need to configure the client to use the same setting as the server. To do this, include one of the following lines in your client's OpenVPN configuration (.ovpn) file:

Setting	Line
SHA1	auth SHA1
SHA256	auth SHA256

Example To configure tunnel 5, which is an OpenVPN tunnel, to use SHA256 data channel authentication, use the commands:

```
awplus# configure terminal
awplus(config)# interface tunnel5
awplus(config-if)# tunnel openvpn authentication SHA256
```

Related commands [tunnel openvpn cipher](#)

Command changes Version 5.4.7-0.1: command added
Version 5.5.0-2.1: command added to AR1050V

tunnel openvpn cipher

Overview Use this command to configure the data channel encryption cipher for an OpenVPN tunnel.

Use the **no** variant of this command to set the data channel encryption cipher for an OpenVPN tunnel to its default value of AES-128.

Syntax tunnel openvpn cipher {aes128|aes256}
no tunnel openvpn cipher

Parameter	Description
aes128	Use Advanced Encryption Standard symmetric key block cipher with a 128-bit key as the data channel encryption cipher.
aes256	Use Advanced Encryption Standard symmetric key block cipher with a 256-bit key as the data channel encryption cipher.

Default AES-128

Mode Interface configuration

Usage notes You need to configure the client to use the same setting as the server. To do this, include one of the following lines in your client's OpenVPN configuration (.ovpn) file:

Setting	Line
AES-128	cipher AES-128-CBC
AES-256	cipher AES-256-CBC

For example, consider a client file tun.ovpn that has the following settings:

```
# tun.ovpn
client
auth-user-pass
cipher AES-128-CBC
dev tap
proto udp
remote 192.168.1.1
ca c:/users/support/cacert.pem
verb 7
```

To change the client to AES-256, replace the line "cipher AES-128-CBC" with "cipher AES-256-CBC".

Example To configure tunnel 5, which is an OpenVPN tunnel, to use AES-256 data channel encryption, use the commands:

```
awplus# configure terminal
awplus(config)# interface tunnel5
awplus(config-if)# tunnel openvpn cipher aes256
```

Related commands [tunnel openvpn authentication](#)

Command changes Version 5.4.7-0.1: command added
Version 5.5.0-2.1: command added to AR1050V

tunnel mode openvpn tap

Overview Use this command to set the tunnel mode to OpenVPN TAP for a tunnel interface.

Use the **no** variant of this command to remove the mode.

TAP is a virtual network device. TAP creates a Virtual Tunnel Interface (VTI) that carries layer 2 frames. You may want to use TAP in the following scenarios:

- You want to use bridges to transport Ethernet frames
- You want to transport any network protocol, such as IPv4, IPv6, IPX

Note that TAP will cause broadcast overhead on the VPN tunnel and add the overhead of Ethernet headers on all packets transported over the VPN tunnel.

Note that the distribution of client IP addresses through DHCP is only supported in TAP mode.

Syntax tunnel mode openvpn tap
no tunnel mode

Mode Interface Configuration

Examples To set tunnel5 to be an OpenVPN tunnel in TAP mode, use the commands:

```
awplus# configure terminal
awplus(config)# interface tunnel5
awplus(config-if)# tunnel mode openvpn tap
```

To remove the configured mode for tunnel5, use the commands:

```
awplus# configure terminal
awplus(config)# interface tunnel5
awplus(config-if)# no tunnel mode
```

Related commands [tunnel mode openvpn tun](#)

Command changes Version 5.5.0-2.1: command added to AR1050V

tunnel mode openvpn tun

Overview Use this command to set the tunnel mode to OpenVPN TUN for a tunnel interface.

Use the **no** variant of this command to remove the mode.

TUN is a virtual network device. TUN creates a Virtual Tunnel Interface (VTI) that carries layer 3 packets. You may want to use TUN in the following scenarios:

- You want to transport traffic that is destined for the VPN client
- You want to transport only layer 3 packets
- You want to support VPN on mobile devices

Note that TUN cannot be used in bridges and broadcast traffic is not transported in TUN mode.

Syntax tunnel mode openvpn tun
no tunnel mode

Mode Interface Configuration

Examples To set tunnel5 to be an OpenVPN tunnel in TUN mode, use the commands:

```
awplus# configure terminal
awplus(config)# interface tunnel5
awplus(config-if)# tunnel mode openvpn tun
```

To remove the configured mode for tunnel5, use the commands:

```
awplus# configure terminal
awplus(config)# interface tunnel5
awplus(config-if)# no tunnel mode
```

Related commands [tunnel mode openvpn tap](#)

Command changes Version 5.5.0-2.1: command added to AR1050V

tunnel openvpn expiry-bytes

Overview Use this command to change how the firewall decides when to renegotiate client keys. By default, client keys are renegotiated after an hour; you can use this command to base rekeying on data usage instead of time.

Use the **no** variant of this command to return to time-based rekeying instead.

Syntax tunnel openvpn expiry-bytes <0-4294967295>
no tunnel openvpn expiry-bytes

Parameter	Description
expiry-bytes <0-4294967295>	The number of bytes of traffic after which the firewall renegotiates client keys. A value of 0 bytes means that keys are not renegotiated after the VPN is formed. Otherwise, setting the expiry-bytes to a non-zero value will cause a rekey when the firewall has received that many bytes of traffic.

Default Not configured - the firewall renegotiates keys every hour instead.

Mode Interface mode for a tunnel

Example To configure tunnel2 to rekey after 1 GB of traffic, use the following commands:

```
awplus# configure terminal
awplus(config)# interface tunnel2
awplus(config-if)# tunnel openvpn expiry-bytes 1000000000
```

To return tunnel2 to the default of rekeying hourly, use the following commands:

```
awplus# configure terminal
awplus(config)# interface tunnel2
awplus(config-if)# no tunnel openvpn expiry-bytes
```

Related commands [tunnel openvpn expiry-seconds](#)

Command changes Version 5.4.7-0.1: command added
Version 5.5.0-2.1: command added to AR1050V

tunnel openvpn expiry-seconds

Overview Use this command to change when client keys are renegotiated. By default, client keys are renegotiated after an hour; you can use this command to turn off renegotiation or to change that time period.

Use the **no** variant of this command to return to the default of 1 hour.

Syntax tunnel openvpn expiry-seconds <0-4294967295>
no tunnel openvpn expiry-seconds

Parameter	Description
expiry-seconds <0-4294967295>	The length of time after which the firewall renegotiates client keys. A value of 0 seconds means that keys are not renegotiated after the VPN is formed. Otherwise, setting the expiry-seconds to a non-zero timer value will cause a rekey when that time is exceeded.

Default 3600 seconds (1 hour).

Mode Interface mode for a tunnel

Example To configure tunnel2 to rekey every 30 minutes, use the following commands:

```
awplus# configure terminal
awplus(config)# interface tunnel2
awplus(config-if)# tunnel openvpn expiry-seconds 1800
```

To return tunnel2 to the default of rekeying hourly, use the following commands:

```
awplus# configure terminal
awplus(config)# interface tunnel2
awplus(config-if)# no tunnel openvpn expiry-seconds
```

Related commands tunnel openvpn expiry-bytes

Command changes Version 5.4.7-0.1: command added
Version 5.5.0-2.1: command added to AR1050V

tunnel openvpn port

Overview Use this command to specify the UDP listening port that is used to receive OpenVPN tunnel connections.

Use the **no** variant to set the port number to its default value which is 1194.

Syntax tunnel openvpn port <1-65535>
no tunnel openvpn port

Parameter	Description
<1-65535>	Port number from 1 through 65535.

Default The default UDP port number is 1194.

Mode Interface Configuration

Usage notes If firewall protection is enabled, you need to create a firewall rule that allows the OpenVPN application traffic to traverse the firewall. OpenVPN is a pre-defined application with destination port number 1194. You can use the [show application detail](#) command to see the application details. If you specify a UDP number that is different to the default port number, you need to create an application with the same specified UDP port number for OpenVPN, and then create a firewall rule to allow the application to traverse the firewall. For more information about firewall rules, see the [rule \(firewall\)](#) command.

Examples To configure tunnel tunnel5 to receive incoming tunnel connections on UDP port 4567, use the commands:

```
awplus(config)# interface tunnel5  
awplus(config-if)# tunnel openvpn port 4567
```

To remove the specified UDP port for tunnel tunnel5 and set the UDP port to its default value, use the commands:

```
awplus# configure terminal  
awplus(config)# interface tunnel5  
awplus(config-if)# no tunnel openvpn port
```

Command changes Version 5.5.0-2.1: command added to AR1050V

tunnel openvpn tagging

Overview This command configures an OpenVPN tunnel to add an 802.1Q tag (a VLAN ID) to traffic received over the tunnel. VLAN ID (VID) is a VLAN identifier that is used to determine which VLAN the traffic belongs to. The VID is determined from information received from the RADIUS server during the authentication process. If no VID information is received from the RADIUS server, the value specified in this command is used.

Use the **no** variant of this command to remove the VID over the tunnel.

Note that you can add an 802.1Q tag in the TAP mode only.

Syntax tunnel openvpn tagging <1-4094>
no tunnel openvpn tagging

Parameter	Description
<1-4094>	VLAN ID from 1 through 4094

Mode Interface Configuration

Examples To add an 802.1Q tag of 1 to packets received over the tunnel named tunnel5, use the commands:

```
awplus# configure terminal
awplus(config)# interface tunnel5
awplus(config-if)# tunnel openvpn tagging 1
```

To remove the 802.1Q tag for the tunnel named tunnel5, use the commands:

```
awplus# configure terminal
awplus(config)# interface tunnel5
awplus(config-if)# no tunnel openvpn tagging
```

Command changes Version 5.5.0-2.1: command added to AR1050V

tunnel openvpn tls-crypt

Overview Use this command to enable TLS Crypt on OpenVPN. TLS Crypt uses a pre-shared key to secure the entire OpenVPN session from the first packet. It provides several potential benefits:

- It prevents detection of the OpenVPN connection start, which is helpful in some situations when the OpenVPN protocol signature is detected and blocked.
- It prevents TLS denial of service attacks. DoS attacks are possible with TLS-Auth, where the attacker can open thousands of TLS connections simultaneously but not provide a valid certificate, jamming the available ports. With TLS Crypt the server would reject the connection up front.
- Data is encrypted twice, once by TLS Crypt and once by the TLS session.

Use the **no** variant of this command to disable TLS Crypt.

Syntax `tunnel openvpn tls-crypt <key-filename>`
`no tunnel openvpn tls-crypt`

Parameter	Description
<code><key-filename></code>	The path to the key file that is shared with the clients. The filename starts with "flash:" (e.g. flash:/openvpn.key). All clients and the server must share the same key file. TLS Crypt will automatically create the configured key file if it doesn't exist.

Default Disabled

Mode Interface Configuration for a tunnel

Example To configure OpenVPN in TAP mode, and use the key file called 'openvpn.key' on tunnel2, use the commands:

```
awplus# configure terminal
awplus(config)# interface tunnel2
awplus(config-if)# tunnel openvpn tls-crypt flash:/openvpn.key
awplus(config-if)# tunnel mode openvpn tap
```

Related commands [tunnel mode openvpn tap](#)
[tunnel mode openvpn tun](#)

Command changes Version 5.5.2-0.1: command added

tunnel security-reprocessing

Overview Use this command to enable stream security reprocessing on all tunnel interfaces.

Use the **no** variant of this command to disable security reprocessing on all tunnel interfaces.

Note that tunnel security reprocessing increases the load on your device and reduces throughput. This is because traffic is processed twice through the DPI engine. Therefore, it should only be enabled if your solution requires it.

Syntax tunnel security-reprocessing
no tunnel security-reprocessing

Default Security reprocessing is disabled by default.

Mode Global Configuration

Usage notes Use this command when you need to reinspect the traffic in a tunnel terminating on the device using stream UTM features after tunnel headers and encryption have been removed. For a configuration example using this command, see the [Internet Protocol Security \(IPsec\) Feature Overview and Configuration Guide](#).

Example To enable security reprocessing, use the commands:

```
awplus# configure terminal
awplus(config)# tunnel security-reprocessing
```

To disable security reprocessing, use the commands:

```
awplus# configure terminal
awplus(config)# no tunnel security-reprocessing
```

Related commands [show interface tunnel \(GRE\)](#)
[show interface tunnel \(IPsec\)](#)
[show interface tunnel \(L2TPv3\)](#)
[show interface tunnel \(OpenVPN\)](#)

Command changes Version 5.4.8-0.2: command added

74

L2TPv2 PPP Commands

Introduction

This chapter provides an alphabetical reference of commands used to configure L2TPv2 tunnels.

For introductory information about tunneling of PPP over L2TPv2 in AlliedWare Plus, including overview and configuration information, see the [L2TPv2 Feature Overview and Configuration Guide](#)

- Command List**
- “[debug l2tp](#)” on page 3734
 - “[destination](#)” on page 3735
 - “[encapsulation ppp](#)” on page 3736
 - “[ip-version](#)” on page 3738
 - “[l2tp tunnel](#)” on page 3739
 - “[l2tp unmanaged port](#)” on page 3741
 - “[l2tp-profile](#)” on page 3742
 - “[local-subaddress](#)” on page 3743
 - “[protection ipsec](#)” on page 3744
 - “[protection local-name](#)” on page 3745
 - “[protection profile](#)” on page 3747
 - “[protection remote-name](#)” on page 3748
 - “[remote-subaddress](#)” on page 3750
 - “[shared-secret](#)” on page 3751
 - “[show debugging l2tp](#)” on page 3752
 - “[show l2tp session](#)” on page 3753
 - “[show l2tp tunnel](#)” on page 3755
 - “[show l2tp tunnel config-check](#)” on page 3759

- [“show running-config l2tp-profile”](#) on page 3761
- [“show running-config l2tp-tunnel”](#) on page 3762
- [“source”](#) on page 3763
- [“version”](#) on page 3764

debug l2tp

Overview Use this command to enable debugging of L2TPv2 tunnels.
Use the **no** variant of this command to disable debugging of L2TPv2 tunnels.

Syntax debug l2tp
no debug l2tp
undebug l2tp

Default Debugging of L2TPv2 tunnels is disabled by default.

Mode Privileged Exec

Example To enable debugging for L2TPv2 tunnels, use the commands:

```
awplus# debug l2tp
awplus# terminal monitor
% Warning: Console logging enabled
```

To disable debugging of L2TPv2 tunnels, use the command:

```
awplus# no debug l2tp
```

or the command:

```
awplus# undebug l2tp
```

Related commands [debug pppoe-ac](#)
[show debugging l2tp](#)

destination

Overview Use this command to set the destination of an L2TP tunnel.

Use the **no** variant of this command to remove the destination from the L2TP tunnel.

Syntax `destination [<ipv4-addr>|<ipv6-addr>|<domain-name>]`
`no destination`

Parameter	Description
<code><ipv4-addr></code>	The destination of the L2TP tunnel as an IPv4 address.
<code><ipv6-addr></code>	The destination of the L2TP tunnel as an IPv6 address.
<code><domain-name></code>	The destination of the L2TP tunnel as a fully-qualified domain name.

Default No destination is set by default.

Mode L2TP Tunnel Configuration

Example To set the destination IP address for tunnel1 to 10.1.1.1, use the commands:

```
awplus# configure terminal
awplus(config)# l2tp tunnel tunnel1
awplus(config-l2tp-tunnel)# destination 10.1.1.1
```

To remove the destination IP address from tunnel1, use the commands:

```
awplus# configure terminal
awplus(config)# l2tp tunnel tunnel1
awplus(config-l2tp-tunnel)# no destination
```

Related commands

- [encapsulation ppp](#)
- [ip-version](#)
- [l2tp tunnel](#)
- [show l2tp tunnel config-check](#)
- [show running-config l2tp-tunnel](#)
- [source](#)
- [version](#)

encapsulation ppp

Overview Use this command to enable PPP encapsulation and create one or more PPP interfaces over Ethernet, a cellular interface, or an L2TPv2 managed VPN.

Use the **no** variant of this command to disable PPP encapsulation and remove the specified PPP interface.

Syntax encapsulation ppp <index>
no encapsulation ppp <index>

Parameter	Description
<index>	The PPP interface index number in the range from 0 to 255.

Default No PPP encapsulation or interfaces are configured by default.

Mode Interface Configuration mode for an Ethernet interface (e.g. **interface eth1**), or an Ethernet sub-interface (e.g. **interface eth1.1**), or a cellular interface (e.g. **interface cellular0**).

L2TP Tunnel Configuration mode for an L2TP tunnel (e.g. **l2tp tunnel tunnel0**).

Examples To configure a PPP interface with index 0 for Ethernet interface eth1, use the commands:

```
awplus# configure terminal
awplus(config)# interface eth1
awplus(config-if)# encapsulation ppp 0
```

To shut down the ppp0 interface and remove it from Ethernet interface eth1, use the commands:

```
awplus# configure terminal
awplus(config)# interface ppp0
awplus(config-if)# shutdown
awplus(config-if)# interface eth1
awplus(config-if)# no encapsulation ppp 0
```

To set the L2TP tunnel tunnel1 to encapsulate the PPP interface with index 1, use the commands:

```
awplus# configure terminal
awplus(config)# l2tp tunnel tunnel1
awplus(config-l2tp-tunnel)# encapsulation ppp 1
```

To remove the PPP interface with index 1 from L2TP tunnel tunnel1, use the commands:

```
awplus# configure terminal
awplus(config)# l2tp tunnel tunnel1
awplus(config-l2tp-tunnel)# no encapsulation ppp 1
```

**Related
commands**

[l2tp tunnel](#)
[ppp service-name \(PPPoE\)](#)
[show interface \(PPP\)](#)

ip-version

Overview Use this command to set the IP version for the L2TP tunnel.
The IP version must be set to the same value at both ends of the tunnel.

Syntax `ip-version [4|6]`

Parameter	Description
4	IPv4
6	IPv6

Default The IP version is set to IPv4 by default.

Mode L2TP Tunnel Configuration

Example To set the IP version for tunnel1 to IPv6, use the commands:

```
awplus# configure terminal
awplus(config)# l2tp tunnel tunnel1
awplus(config-l2tp-tunnel)# ip-version 6
```

To set the IP version for tunnel1 to the default (IPv4), use the commands:

```
awplus# configure terminal
awplus(config)# l2tp tunnel tunnel1
awplus(config-l2tp-tunnel)# ip-version 4
```

Related commands

- [encapsulation ppp](#)
- [ip-version](#)
- [l2tp tunnel](#)
- [show running-config l2tp-tunnel](#)
- [show l2tp tunnel config-check](#)
- [source](#)
- [version](#)

l2tp tunnel

Overview Use this command to create a named L2TP tunnel, and to enter L2TP Tunnel Configuration mode to configure it.

Use the **no** variant of this command to remove the named tunnel and all of its configuration.

Syntax `l2tp tunnel <tunnel-name>`
`no l2tp tunnel <tunnel-name>`

Parameter	Description
<code><tunnel-name></code>	The name of the tunnel to create, change or delete.

Default No L2TP tunnel is configured by default.

Mode Global Configuration

Example To create and begin configuring a new L2TP tunnel named 'tunnel1', use the commands:

```
awplus# configure terminal
awplus(config)# l2tp tunnel tunnel1
awplus(config-l2tp-tunnel)#
```

To remove the tunnel 'tunnel1' and its configuration, use the commands:

```
awplus# configure terminal
awplus(config)# no l2tp tunnel tunnel1
```

Related commands

- [destination](#)
- [encapsulation ppp](#)
- [ip-version](#)
- [local-subaddress](#)
- [protection ipsec](#)
- [protection local-name](#)
- [protection profile](#)
- [protection remote-name](#)
- [remote-subaddress](#)
- [shared-secret](#)
- [show l2tp session](#)
- [show l2tp tunnel](#)

show l2tp tunnel config-check
show running-config l2tp-tunnel
source
version

l2tp unmanaged port

Overview Use this command to set the UDP port for an (IPv4 and IPv6) unmanaged L2TP tunnel (L2TPv3 Ethernet Pseudowires).

This command can only change the UDP port when there is no unmanaged L2TP tunnel (L2TPv3 Ethernet Pseudowires) configured.

Use the **no** variant of this command to reset the UDP port to the default (1701).

Syntax `l2tp unmanaged port [<1-65535>]`
`no l2tp unmanaged port`

Parameter	Description
<1-65535>	The number of the UDP port to use for an unmanaged L2TP tunnel (L2TPv3 Ethernet Pseudowires).

Default The UDP port is 1701 by default.

Mode Global Configuration

Usage notes The default UDP port for both unmanaged and managed L2TP tunnels is 1701. If both kinds of tunnel will be configured, the UDP port for the unmanaged tunnel must be changed to a different port by using the **l2tp unmanaged port** command.

Be aware of potential clashes with other UDP port users. Unless it is likely to be used for other purposes, we recommend configuring UDP port 1702 as a suitable alternative.

Example To set the UDP port for an L2TP unmanaged tunnel (L2TPv3 Ethernet Pseudowires) to 1702, use the following commands:

```
awplus# configure terminal
awplus(config)# l2tp unmanaged port 1702
```

Related commands [tunnel mode l2tp v3](#)
[show running-config](#)

l2tp-profile

Overview Use this command to create an L2TP profile and to enter the L2TP Profile Configuration mode.

Use the **no** variant of this command to remove the L2TP profile and all its configuration.

Syntax `l2tp-profile <name>`
`no l2tp-profile <name>`

Parameter	Description
<code><name></code>	The name of the L2TP profile being created or configured.

Default No L2TP profile is configured by default. This command is not configured by default.

Mode Global Configuration

Example To create a L2TP profile named "public", use the commands:

```
awplus# configure terminal
awplus(config)# l2tp-profile public
awplus(config-l2tp-profile)#
```

To remove all configuration of this L2TP profile, use the commands:

```
awplus# configure terminal
awplus(config)# no l2tp-profile public
```

Related commands

- [l2tp profile](#)
- [pppoe-ac](#)
- [shared-secret](#)
- [show running-config l2tp-profile](#)
- [version](#)

local-subaddress

Overview Use this command to set the local sub-address for L2TPv2 tunnel authentication. Use the **no** variant of this command to remove the configured local sub-address.

Syntax local-subaddress [*<sub-address>*]
no local-subaddress

Parameter	Description
<i><sub-address></i>	The local sub-address for the tunnel.

Default The local sub-address is not set by default; by default, the received L2TPv2 sub-address AVP will not be checked before establishing the tunnel.

Mode L2TP Tunnel Configuration

Usage notes If a local sub-address is set, this is checked against incoming the sub-address AVP as a requirement for tunnel establishment. The received sub-address AVP content must match the configured local sub-address.

Example To set the local-sub address of tunnel1 to 'office1', use the commands:

```
awplus# configure terminal
awplus(config)# l2tp tunnel tunnel1
awplus(config-l2tp-tunnel)# local-subaddress office1
```

To remove the local sub-address configuration from tunnel1, use the commands:

```
awplus# configure terminal
awplus(config)# l2tp tunnel tunnel1
awplus(config-l2tp-tunnel)# no local-subaddress
```

Related commands

- [l2tp tunnel](#)
- [remote-subaddress](#)
- [show l2tp tunnel config-check](#)
- [show running-config l2tp-tunnel](#)

protection ipsec

Overview Use this command to enable IPsec protection on the L2TP tunnel.
Use the **no** variant of this command to disable IPsec on the tunnel.

Syntax protection ipsec
no protection ipsec

Default IPsec protection is disabled by default.

Mode L2TP Tunnel Configuration

Example To protect tunnel1 with IPsec, use the commands:

```
awplus# configure terminal
awplus(config)# l2tp tunnel tunnel1
awplus(config-l2tp-tunnel)# protection ipsec
```

To disable IPsec protection for tunnel1, use the commands:

```
awplus# configure terminal
awplus(config)# l2tp tunnel tunnel1
awplus(config-l2tp-tunnel)# no protection ipsec
```

Related commands

- [l2tp tunnel](#)
- [protection ipsec](#)
- [protection local-name](#)
- [protection profile](#)
- [protection remote-name](#)
- [show l2tp tunnel config-check](#)
- [show running-config l2tp-tunnel](#)

protection local-name

Overview Use this command to set the IPsec local name for the L2TP tunnel. This is the local identifier for IKE.

Use the **no** variant of this command to reset the local name to the default—the source IP address of the L2TP tunnel.

Syntax protection local-name [<ipsec-local-name>]
no protection local-name

Parameter	Description
<ipsec-local-name>	The IPsec local name for the tunnel.

Default By default, the IPsec local name is set to the source IP address of the L2TP tunnel.

Mode L2TP Tunnel Configuration

Usage notes If no local name is configured with this command, the source IP address of the tunnel is used. If a local name is configured with this command, the **crypto isakmp key** command is required to configure a preshared authentication key using this local name as the hostname.

Example To set the IPsec local name for tunnel1 to office1 and set the key to 'friend', use the commands:

```
awplus# configure terminal
awplus(config)# l2tp tunnel tunnel1
awplus(config-l2tp-tunnel)# protection ipsec
awplus(config-l2tp-tunnel)# protection local-name office1
awplus(config)# crypto isakmp key friend hostname office1
```

To remove the IPsec local name for tunnel1, use the commands:

```
awplus# configure terminal
awplus(config)# l2tp tunnel tunnel1
awplus(config-l2tp-tunnel)# no protection local-name
```

Related commands

- [crypto isakmp key](#)
- [l2tp tunnel](#)
- [protection ipsec](#)
- [protection profile](#)
- [protection remote-name](#)
- [show l2tp tunnel config-check](#)

show running-config l2tp-tunnel

protection profile

Overview Use this command to set the IPsec profile to use for this L2TP tunnel.
Use the **no** variant of this command to set it back to the default IPsec profile: the profile named 'default'.

Syntax protection profile [*<profile-name>*]
no protection profile

Parameter	Description
<i><profile-name></i>	The name of the IPsec profile to use. This is the profile created by the crypto ipsec profile command.

Default The L2TP tunnel protection profile is set to the IPsec profile named 'default' by default.

Mode L2TP Tunnel Configuration

Example To set up tunnel1 with IPsec protection using IPsec profile 'profile1', use the commands:

```
awplus# configure terminal
awplus(config)# l2tp tunnel tunnel1
awplus(config-l2tp-tunnel)# protection ipsec
awplus(config-l2tp-tunnel)# protection profile profile1
```

To reset tunnel1 to use IPsec protection with IPsec profile 'default', use the commands:

```
awplus# configure terminal
awplus(config)# l2tp tunnel tunnel1
awplus(config-l2tp-tunnel)# no protection profile
```

Related commands

- [crypto ipsec profile](#)
- [l2tp tunnel](#)
- [protection ipsec](#)
- [protection local-name](#)
- [protection remote-name](#)
- [show l2tp tunnel config-check](#)
- [show running-config l2tp-tunnel](#)

protection remote-name

Overview Use this command to set the L2TP tunnel IPsec remote name. This is the remote identifier for IKE.

Use the **no** variant of this command to reset the remote name to the default—the destination IP address of the tunnel.

Syntax protection remote-name [*<ipsec-remote-name>*]
no protection remote-name

Parameter	Description
<i><ipsec-remote-name></i>	The IPsec remote name for the tunnel.

Default By default, the IPsec remote name is set to the destination IP address of the tunnel.

Mode L2TP Tunnel Configuration

Usage notes In order to set the IPsec remote name for the tunnel and add a corresponding ISAKMP key for the tunnel, set the IPsec remote name with this command (**protection remote-name**) and set the key for this by using the **crypto isakmp key** command with this remote name as the hostname.

Example To set the IPsec remote name for tunnel1 to 'office2' and set the key to 'friend', use the commands:

```
awplus# configure terminal
awplus(config)# l2tp tunnel tunnel1
awplus(config-l2tp-tunnel)# protection ipsec
awplus(config-l2tp-tunnel)# protection remote-name office2
awplus(config)# crypto isakmp key friend hostname office2
```

To reset the IPsec remote name for tunnel1 to default (destination IP address of the tunnel), use the commands:

```
awplus# configure terminal
awplus(config)# l2tp tunnel tunnel1
awplus(config-l2tp-tunnel)# no protection remote-name
```

Related commands

- [crypto isakmp key](#)
- [l2tp tunnel](#)
- [protection ipsec](#)
- [protection local-name](#)
- [protection profile](#)
- [show l2tp tunnel config-check](#)

`show running-config l2tp-tunnel`

remote-subaddress

Overview Use this command to set the remote sub-address for L2TPv2 tunnel authentication.

Use the **no** variant of this command to remove the sub-address from the tunnel configuration.

Syntax `remote-subaddress [<sub-address>]`
`no remote-subaddress`

Parameter	Description
<code><sub-address></code>	The remote sub-address for the tunnel.

Default The remote sub-address is not set by default; the outgoing L2TP sub-address AVP for the tunnel will not be populated.

Mode L2TP Tunnel Configuration

Usage notes If the L2TP peer is also an AR-Series firewall, the remote-subaddress must match the local sub-address configured at the other end of the tunnel.

If a remote sub-address is configured for the tunnel, this value is placed in the outgoing sub-address AVP. The other tunnel end point can check this value against its configured local sub-address for the tunnel before establishing the tunnel.

Example To set the remote sub-address of tunnel1 to 'office1', use the commands:

```
awplus# configure terminal
awplus(config)# l2tp tunnel tunnel1
awplus(config-l2tp-tunnel)# remote-subaddress office1
```

To remove the remote sub-address configuration from tunnel1, use the commands:

```
awplus# configure terminal
awplus(config)# l2tp tunnel tunnel1
awplus(config-l2tp-tunnel)# no remote-subaddress
```

Related commands

- [l2tp tunnel](#)
- [local-subaddress](#)
- [show l2tp tunnel config-check](#)
- [show running-config l2tp-tunnel](#)

shared-secret

Overview Use this command to set the secret password that is shared with L2TP tunnel peers. Use the **no** variant of this command to remove the shared secret.

Syntax `shared-secret <secret>`
`no shared-secret`

Parameter	Description
<code><secret></code>	The password shared with the tunnel peer.

Default No shared secret is configured by default.

Mode L2TP Profile Configuration and L2TP Tunnel Configuration

Example To set tunnel secret to "my_password" for tunnel profile "public", use the commands:

```
awplus# configure terminal
awplus(config)# l2tp-profile public
awplus(config-l2tp-profile)# shared-secret my_password
```

To set tunnel secret to "my_password" for tunnel "tunnelone", use the commands:

```
awplus# configure terminal
awplus(config)# l2tp tunnel tunnelone
awplus(config-l2tp-tunnel)# shared-secret my_password
```

To remove the tunnel secret for the tunnel profile, use the commands:

```
awplus# configure terminal
awplus(config)# l2tp-profile public
awplus(config-l2tp-profile)# no shared-secret
```

To remove the tunnel secret for the tunnel 'tunnelone', use the commands:

```
awplus# configure terminal
awplus(config)# l2tp tunnel tunnelone
awplus(config-l2tp-tunnel)# no shared-secret
```

Related commands

- [l2tp tunnel](#)
- [l2tp-profile](#)
- [show running-config l2tp-profile](#)
- [version](#)

show debugging l2tp

Overview Use this command to see what debugging is turned on for L2TP tunnels.

Syntax `show debugging l2tp`

Mode Privileged Exec

Example To display whether debugging of L2TP tunnels is on or off, use the command:

```
awplus# show debugging l2tp
```

Output Figure 74-1: Example output from **show debugging l2tp**

```
awplus#show debugging l2tp
L2TP Tunnel Debugging is on
```

Related commands [debug l2tp](#)

show l2tp session

Overview Use this command to display a summary or detailed list of information about L2TP sessions.

Syntax `show l2tp session [detail]`

Parameter	Description
detail	Displays more detailed information about L2TP sessions.

Mode Privileged Exec

Example To display summary information about all L2TPv2 sessions, use the command:

```
awplus# show l2tp session
```

Output Figure 74-2: Example output from **show l2tp session**

```
awplus#show l2tp session
L2TP Session Information
-----
Session ID:                59400
Tunnel ID:                 25351
State:                     RETRY
Type:                      LAIC
Created At:                May 31 20:03:04 2016
Interface Name:            ppp1
Remote Session ID:        61156
Establish Timeout:        120
```

Table 74-1: Parameters in the output from **show l2tp session**

Parameter	Description
Session ID	L2TP session ID.
Tunnel ID	The ID of the L2TP tunnel for this session.

Table 74-1: Parameters in the output from **show l2tp session** (cont.)

Parameter	Description
State	The current state of the L2TP session: <ul style="list-style-type: none"> idle—Idle wait-tunnel—Await tunnel wait-reply—Await reply wait-connect—Await connect wait-cs-answer—Await circuit switched answer established—Successful connection retry—Retrying connection
Type	The type of the L2TP session: <ul style="list-style-type: none"> LAIC—LAC incoming call LAOC—LAC outgoing call LNIC—LNS incoming call LNOC—LNS outgoing call UNSPEC—unspecified call type
Created At	The date and time when the session was created.
Interface Name	The name of the interface for this session.
Remote Session ID	The ID of the session on the peer.
Establish Timeout	The time (in seconds) that a session will wait for the peer to complete the session setup message exchange.

Related commands [l2tp tunnel](#)
[show l2tp tunnel](#)

show l2tp tunnel

Overview Use this command to display information about all the current L2TP tunnels.

Syntax `show l2tp tunnel [detail]`

Parameter	Description
detail	Display additional detailed information about the tunnels.

Mode Privileged Exec

Usage notes The output from this command depends on whether it won the tiebreaker and took the LAC role for the tunnel, or lost the tiebreaker and took the LNS role. In the latter case, a corresponding idle LAC tunnel is also displayed.

Example To display information about all L2TPv2 tunnels, use the command:

```
awplus# show l2tp tunnel
```

Output Figure 74-3: Example output from **show l2tp tunnel**

```
AWP-2#show l2tp tunnel

L2TP Tunnel Information
-----
Tunnel ID:                25351
Tunnel Name:              tunnell
Local IP Address:         10.1.1.2
Remote IP Address:       10.1.1.1
State:                   ESTABLISHED
Created At:              May 31 20:03:04 2016
Tunnel Mode:             LAC
Remote Tunnel ID:        43832
Remote Host Name:        AWP-1
Remote Vendor Name:      Allied Telesis International
Local UDP Port:          1701
Remote UDP Port:         1701
Hello Timeout:           60
Retry Timeout:           1
Idle Timeout:            0
Establish Timeout:       60
```

Figure 74-4: Example output from **show l2tp tunnel detail**

```
awplus#show l2tp tunnel detail

L2TP Tunnel Information details

Tunnel 25351, from 10.1.1.2 to 10.1.1.1:-
  state: ESTABLISHED
  created at: May 31 20:03:04 2016
  administrative name: 'tunnell1'
  created by admin: YES, tunnel mode: LAC, persist: YES
  peer tunnel id: 43832, host name: AWP-1
  UDP ports: local 1701, peer 1701
  authorization mode: CHALLENGE, hide AVPs: OFF
  digest type: md5
  tunnel secret: 'hello'
  session limit: 0, session count: 1
  tunnel profile: tunnel_profile_tunnell1, session profile:
    session_profile_tunnell1, peer profile: peer_profile_tunnell1
  hello timeout: 60, retry timeout: 1, idle timeout: 0
  establish timeout: 60
  persist pend timeout: 60
  rx window size: 10, tx window size: 10, max retries: 5
  use udp checksums: ON
  do pmtu discovery: OFF, mtu: 1460
  tos: inherit
  framing capability: SYNC ASYNC, bearer capability: DIGITAL
ANALOG
  use tiebreaker: ON
  tiebreaker: f6 5e 50 9c 02 99 45 83
  interoperability flags: 128
  trace flags: PROTOCOL FSM API AVP FUNC XPRT DATA PPP SYSTEM
Status:-
  peer vendor name: Allied Telesis International
  peer protocol version: 1.0, firmware 385
  peer framing capability: SYNC ASYNC
  peer bearer capability: DIGITAL ANALOG
  peer rx window size: 10
Transport status:-
  ns/nr: 8/9, peer 8/8
  cwnd: 9, ssthresh: 10, congpkt_acc: 0
Transport statistics:-
  out-of-sequence control/data discards: 0/0
  zlbs tx/txfail/rx: 6/0/5
  retransmits: 0, duplicate pkt discards: 0, data pkt discards:
    0
  hellos tx/txfail/rx: 1/0/5
  control rx packets: 14, rx bytes: 413
  control tx packets: 14, tx bytes: 542
  data rx packets: 4, rx bytes: 100, rx errors: 0
  data tx packets: 14, tx bytes: 512, tx errors: 0
memory usage: 2111 bytes
Events:-
  20:03:04 OPEN_REQ in state IDLE, new state WAITCTLREPLY
  20:03:04 SCCRP_ACCEPT in state WAITCTLREPLY, new state
ESTABLISHED
```

Table 75: Parameters in the output from **show l2tp tunnel** .

Parameter	Description
Tunnel ID	The L2TP tunnel ID, (assigned automatically by the device).
Tunnel Name	The name of the L2TP tunnel as specified by the l2tp tunnel command.
Local IP Address	The IPv4 or IPv6 address of the tunnel on this device. This is either specified by the configuration if the device is in LAC mode, or assigned automatically by the device if it is in LNS mode. This may be specified directly by the source command, or derived from the interface set by that command.
Remote IP Address	The IPv4 or IPv6 address of the device at the remote end of the tunnel. This may be specified directly by the destination command, or derived from a domain name set by that command.
State	The current state of the tunnel: <ul style="list-style-type: none"> idle—Idle wait-ctl-reply—Await control reply wait-ctl-conn—Await connect reply established—Successful connection closing—Closing connection retry—Tie breaker lost, retrying connection
Created at	The date and time when the tunnel was created.
Tunnel Mode	The tunnel mode: <ul style="list-style-type: none"> LAC—L2TP Access Concentrator—the initiating end of the tunnel LNS—L2TP Network Server—the other end of the tunnel, authenticates the user and starts the PPP negotiation.
Remote Tunnel ID	The tunnel ID on the L2TP peer.
Remote Host Name	The host name of the L2TP peer.
Remote Vendor Name	The name of the vendor for the L2TP peer device. E.g. Allied Telesis International.
Local UDP Port	By default the local UDP port used for both L2TPv2 managed tunnels and L2TPv3 unmanaged tunnels (Ethernet Pseudowires) is 1701. If both are configured, change the UDP port for the unmanaged tunnel (l2tp unmanaged port command).
Remote UDP Port	The UPD port used by the remote device for this L2TP tunnel.

Table 75: Parameters in the output from **show l2tp tunnel** . (cont.)

Parameter	Description
Hello Timeout	The period between sending L2TP Hello messages (in seconds).
Retry Timeout	The delay (in seconds) before sending the first retry of unacknowledged control frames.
Idle Timeout	The time (in seconds) that a tunnel will remain after its last session has been torn down.
Establish Timeout	The time (in seconds) that a tunnel will wait for the peer to complete the tunnel setup message exchange.

Related commands [l2tp tunnel](#)

show l2tp tunnel config-check

Overview Use this command to check the configuration of the specified L2TP tunnel or all L2TP tunnels for errors or missing required configuration.

Syntax `show l2tp tunnel [<tunnel-name>] config-check`

Parameter	Description
<code><tunnel-name></code>	The name of the L2TP tunnel to check. If not specified, all tunnels are checked.

Mode Privileged Exec

Usage notes Only tunnels that have a complete configuration may appear in the **show l2tp tunnel** commands. For details of the configuration in the system, use the **show running-config l2tp-tunnel** command.

Example To check for missing L2TP tunnel configuration for the tunnel 'tunnel1', use the command:

```
awplus# show l2tp tunnel config-check
```

Output Figure 74-5: Example output from **show l2tp tunnel config-check**

```
awplus#show l2tp tunnel config-check

L2TP Tunnel tunnel1:
  Complete Configuration

L2TP Tunnel tunnel2:
  Incomplete Configuration
  Missing tunnel name or tunnel name mismatch
  Required: PPP interface
  Required: destination
  Source IP address required when IPsec protection on
```

Table 74-1: Parameters in the output from **show l2tp tunnel config-check**

Parameter	Description
Complete configuration	The tunnel has a complete and valid configuration.
Incomplete configuration	<p>There is configuration still required or invalid for this tunnel, as specified.</p> <p>Examples of possible messages indicating missing or invalid configuration include:</p> <ul style="list-style-type: none">• Missing tunnel name or tunnel name mismatch• Required: PPP interface• Required: destination• Required: IP version• Destination IP address does not match the configured IP version• Source IP address does not match the configured IP version• Source IP address required when IPSec protection on

Related commands [show running-config l2tp-tunnel](#)

show running-config l2tp-profile

Overview Use this command to display the running configuration for L2Tp profiles.

Syntax `show running-config l2tp-profile`

Mode Privileged Exec

Example To display the running configuration of L2TP profiles, use the command:

```
awplus# show running-config l2tp-profile
```

Output Figure 74-6: Example output from **show running-config l2tp-profile**

```
awplus#show running-config l2tp-profile

l2tp-profile public
version 2
secret "my_password"
```

Related commands

- [l2tp-profile](#)
- [shared-secret](#)
- [version](#)

show running-config l2tp-tunnel

Overview Use this command to display the current details for L2TP tunnel configuration.

Syntax `show running-config l2tp-tunnel`

Mode Privileged Exec

Example To display the L2TP tunnel running configuration, use the command:

```
awplus# show running-config l2tp-tunnel
```

Output Figure 74-7: Example output from **show running-config l2tp-tunnel**

```
awplus#show running-config l2tp-tunnel
l2tp tunnel example
  version 2
  ip-version 4
  encapsulation ppp 0
  source 1.0.0.2
  destination 1.0.0.1
  local-subaddress TUNNEL2
  remote-subaddress TUNNEL1
!
```

Related commands

[destination](#)
[encapsulation ppp](#)
[ip-version](#)
[l2tp tunnel](#)
[local-subaddress](#)
[protection ipsec](#)
[protection local-name](#)
[protection profile](#)
[protection remote-name](#)
[remote-subaddress](#)
[shared-secret](#)
[show l2tp tunnel config-check](#)
[source](#)
[version](#)

source

Overview Use this command to set the source address or interface for an L2TP tunnel.

Use the **no** variant of this command to remove the source address or interface from an L2TP tunnel.

Syntax `source [<interface-name>|<ipv4-addr>|<ipv6-addr>`
`no source`

Parameter	Description
<code><interface-name></code>	The name of the interface to be used as the tunnel starting point.
<code><ipv4-addr></code>	The IPv4 address to be used as the tunnel starting point.
<code><ipv6-addr></code>	The IPv6 address to be used as the tunnel starting point.

Default If no source address or interface is configured, the source address used will be calculated based on the route to the tunnel destination.

Mode L2TP Tunnel Configuration

Example To configure IP address 10.1.1.2 as the source address for the tunnel named 'tunnel1', use the commands:

```
awplus# configure terminal
awplus(config)# l2tp tunnel tunnel1
awplus(config-l2tp-tunnel)# source 10.1.1.2
```

To remove the configured source address from 'tunnel1', so that it uses the default source, use the commands:

```
awplus# configure terminal
awplus(config)# l2tp tunnel tunnel1
awplus(config-l2tp-tunnel)# no source
```

Related commands [destination](#)
[l2tp tunnel](#)

[show l2tp tunnel](#)

version

Overview Use this command to specify the protocol version of a L2TP tunnel.

Syntax `version [<version>]`

Parameter	Description
<code><version></code>	The protocol version of the L2TP tunnel. Version 2 is supported.

Default The L2TP version is 2 by default.

Mode L2TP Profile Configuration and L2TP Tunnel Configuration

Example To use L2TPv2 for L2TP tunnel profile 'public', use the commands:

```
awplus# configure terminal
awplus(config)# l2tp-profile public
awplus(config-l2tp-profile)# version 2
```

To use L2TPv2 for L2TP tunnel 'tunnelone', use the commands:

```
awplus# configure terminal
awplus(config)# l2tp tunnel tunnelone
awplus(config-l2tp-tunnel)# version 2
```

Related commands

- [l2tp tunnel](#)
- [l2tp-profile](#)
- [shared-secret](#)
- [show running-config l2tp-profile](#)

75

L2TPv3 Ethernet Pseudowire Commands

Introduction

Overview This chapter provides an alphabetical reference of commands used to configure L2TPv3 Ethernet pseudowires.

For introductory information about L2TPv3 in AlliedWare Plus, including overview and configuration information, see the [L2TPv3 Ethernet Pseudowire Feature Overview and Configuration Guide](#).

- Command List**
- “[interface tunnel \(L2TPv3\)](#)” on page 3766
 - “[l2tp unmanaged port](#)” on page 3767
 - “[show interface tunnel \(L2TPv3\)](#)” on page 3768
 - “[tunnel destination \(L2TPv3\)](#)” on page 3769
 - “[tunnel df](#)” on page 3771
 - “[tunnel local id](#)” on page 3772
 - “[tunnel mode l2tp v3](#)” on page 3773
 - “[tunnel protection ipsec](#)” on page 3774
 - “[tunnel remote id](#)” on page 3775
 - “[tunnel security-reprocessing](#)” on page 3776
 - “[tunnel source \(L2TPv3\)](#)” on page 3777

interface tunnel (L2TPv3)

Overview Use this command to create a tunnel interface or to enter Interface mode to configure an existing tunnel. Tunnel interfaces are identified by an index identifier that is an integer in the range from 0 through 65535.

Use the **no** variant of this command to remove a previously created tunnel interface.

Syntax `interface tunnel<0-65535>`
`no interface tunnel<tunnel-index>`

Parameter	Description
<code><0-65535></code>	Specify a tunnel interface index identifier in the range from 0 through 65535.

Default Tunnel interfaces do not exist.

Mode Global Configuration

Usage notes After you have created the tunnel interface, use the **tunnel mode** command to enable the tunnel.

Examples To configure a tunnel interface with index 30 and enable L2TPv3 mode, use the commands:

```
awplus# configure terminal
awplus(config)# interface tunnel30
awplus(config-if)# tunnel mode l2tp v3
```

To remove the tunnel interface tunnel30, use the commands:

```
awplus# configure terminal
awplus(config)# no interface tunnel30
```

Related commands [show interface tunnel \(L2TPv3\)](#)
[tunnel mode l2tp v3](#)

Command changes Version 5.4.7-2.1: increased range for **tunnel** index identifiers.

l2tp unmanaged port

Overview Use this command to set the UDP port for an (IPv4 and IPv6) unmanaged L2TP tunnel (L2TPv3 Ethernet Pseudowires).

This command can only change the UDP port when there is no unmanaged L2TP tunnel (L2TPv3 Ethernet Pseudowires) configured.

Use the **no** variant of this command to reset the UDP port to the default (1701).

Syntax `l2tp unmanaged port [<1-65535>]`
`no l2tp unmanaged port`

Parameter	Description
<1-65535>	The number of the UDP port to use for an unmanaged L2TP tunnel (L2TPv3 Ethernet Pseudowires).

Default The UDP port is 1701 by default.

Mode Global Configuration

Usage notes The default UDP port for both unmanaged and managed L2TP tunnels is 1701. If both kinds of tunnel will be configured, the UDP port for the unmanaged tunnel must be changed to a different port by using the **l2tp unmanaged port** command.

Be aware of potential clashes with other UDP port users. Unless it is likely to be used for other purposes, we recommend configuring UDP port 1702 as a suitable alternative.

Example To set the UDP port for an L2TP unmanaged tunnel (L2TPv3 Ethernet Pseudowires) to 1702, use the following commands:

```
awplus# configure terminal
awplus(config)# l2tp unmanaged port 1702
```

Related commands [tunnel mode l2tp v3](#)
[show running-config](#)

show interface tunnel (L2TPv3)

Overview Use this command to display status information of a tunnel.

Syntax show interface tunnel<0-65535>

Parameter	Description
<0-65535>	Specify a tunnel index in the range from 0 through 65535.

Mode Privileged Exec

Examples To display status information for L2TPv3 tunnel tunnel20, use the command.

```
awplus#show interface tunnel20
```

Output Figure 75-1: Example output from **show tunnel interface** on the console.

```
awplus#show interface tunnel20
Interface tunnel20
  Link is UP, administrative state is UP
  Hardware is Tunnel
  IPv4 address 192.168.10.1/24 broadcast 192.168.10.255
  IPv6 address 2001:db8:10::1/64
  IPv6 address fe80::5054:d4ff:fe84:d1aa/64
  index 16795714 metric 1 mtu 1480
  arp ageing timeout 300
  <UP,BROADCAST,RUNNING,MULTICAST>
  SNMP link-status traps: Disabled
  Tunnel source 192.168.1.1, destination 192.168.1.2
  Tunnel name local 192.168.1.1, remote 192.168.1.2
  Tunnel ID local 66, remote 77
  Tunnel protocol/transport l2tp v3, key disabled, sequencing
  disabled
  Tunnel TTL inherit
  Checksumming of packets disabled, path MTU discovery disabled
  input packets 0, bytes 0, dropped 0, multicast packets 0
  output packets 5, bytes 366, multicast packets 0 broadcast
  packets 0
  Time since last state change: 0 days 00:00:24
```

Related commands [interface tunnel \(L2TPv3\)](#)

tunnel destination (L2TPv3)

Overview Use this command to specify a tunnel destination for the remote end of the tunnel. Tunnel destination can be specified by using a destination network name or an IPv4 address.

Use the **no** variant of this command to remove a configured tunnel destination.

Syntax tunnel destination {<ipv4-addr>|<destination-network-name>}
no tunnel destination

Parameter	Description
<ipv4-addr>	Specify the tunnel destination IPv4 address in the dotted decimal format A.B.C.D. The endpoints of the tunnel must be configured by mirroring IP addresses, that is, the tunnel source on one endpoint must be specified as the tunnel destination on the other endpoint.
<destination-network-name>	Destination network name. If the destination network name cannot be resolved, then the L2TPv3 tunnel remains inactive.

Mode Interface Configuration

Examples To configure an IPv4 tunnel destination by using an IPv4 address, use the commands:

```
awplus# configure terminal
awplus(config)# interface tunnel40
awplus(config-if)# tunnel mode l2tp v3
awplus(config-if)# tunnel destination 2.2.2.2
```

To configure an L2TPv3 tunnel destination by using a destination network name, use the commands:

```
awplus# configure terminal
awplus(config)# interface tunnel40
awplus(config-if)# tunnel mode l2tp v3
awplus(config-if)# tunnel destination
corporate_lan.example.com
```

To remove a tunnel destination, use the commands:

```
awplus# configure terminal
awplus(config)# interface tunnel40
awplus(config-if)# no tunnel destination
```

Related commands interface tunnel (L2TPv3)
tunnel mode l2tp v3
tunnel source (L2TPv3)

tunnel df

Overview Use this command to specify whether the DF (Don't Fragment) bit in the IP header should be set or not on outgoing packets from L2TPv3 tunnels.

Use the **no** variant of this command to return to the default setting.

Syntax tunnel df {set|clear}
no tunnel df

Parameter	Description
set	Set the DF bit in the outer header
clear	Clear the DF bit in the outer header

Default The DF bit is **set** on all outgoing packets.

Mode Interface Configuration

Usage notes This command gives you the opportunity to clear the DF bit allowing packets greater than the MTU to be fragmented and transmitted via the L2TPv3 Ethernet pseudo-wire. This may be necessary if an L2TPv3 tunnel is connected to a bridge and MTU-exceeded messages cannot be sent back to clients.

NOTE: *If fragmentation of larger packets occurs as a result of setting the tunnel Do Not Fragment bit to clear, this may slightly increase latency of the associated traffic flow traversing the VPN, due to the fragmentation and re-assembly that occurs.*

Example To specify the DF bit on the L2TPv3 tunnel (tunnel2), use the following commands:

```
awplus# configure terminal
awplus(config)# interface tunnel2
awplus(config-if)# tunnel mode l2tp v3
awplus(config-if)# tunnel df clear
```

To set the DF bit on the L2TPv3 tunnel (tunnel2) back to the default, use the following commands:

```
awplus# configure terminal
awplus(config)# interface tunnel2
awplus(config-if)# no tunnel df
```

Related commands [tunnel mode l2tp v3](#)

Command changes Version 5.4.9-1.1: command added

tunnel local id

Overview This command specifies a tunnel local identifier sent to the peer to match. Use the **no** variant of this command to remove the tunnel local ID.

Syntax tunnel local id <1-2147483647>
no tunnel local id

Parameter	Description
<1-2147483647>	Tunnel ID from 1 through 2147483647

Default No tunnel local ID is set.

Mode Interface Configuration

Usage notes The endpoints of the tunnel must be configured by mirroring tunnel IDs, that is, the tunnel local ID on one endpoint must be specified as the tunnel remote ID on the other endpoint.

The local session ID defaults to the tunnel local ID and the local session ID is not configurable. A session provides the data channel in L2TPv3. There is a single pseudowire per L2TP session.

Examples To specify a tunnel local ID, use the commands:

```
awplus#configure terminal
awplus(config)#interface tunnel20
awplus(config-if)#tunnel mode l2tp v3
awplus(config-if)#tunnel local id 22
```

To remove the tunnel local ID, use the commands:

```
awplus#configure terminal
awplus(config)#interface tunnel20
awplus(config-if)#no tunnel local id
```

Related commands [tunnel remote id](#)

Validation Commands [show interface tunnel \(L2TPv3\)](#)

tunnel mode l2tp v3

Overview Use this command to configure the encapsulation tunneling mode.
Use the **no** variant of this command to remove an established tunnel.

Syntax tunnel mode l2tp v3 [ipv6]
no tunnel mode

Parameter	Description
ipv6	Specify IPv6 as the delivery protocol.

Default Virtual tunnel interfaces have no mode set by default. If you specify a mode of **l2tp v3**, the delivery protocol is IPv4 unless you specify IPv6.

Mode Interface Configuration

Usage notes A tunnel will not become operational until it is configured with this command.

Examples To configure L2TPv3 as the encapsulation tunneling mode for tunnel20, use the commands:

```
awplus#configure terminal
awplus(config)#interface tunnel20
awplus(config-if)#tunnel mode l2tp v3
```

To remove the established tunnel20, use the commands:

```
awplus#configure terminal
awplus(config)#interface tunnel20
awplus(config-if)#no tunnel mode
```

Related commands [interface tunnel \(L2TPv3\)](#)
[show interface tunnel \(L2TPv3\)](#)
[tunnel df](#)

tunnel protection ipsec

Overview Use this command to optionally enable IPsec protection for packets encapsulated by this tunnel.

Use the **no** variant of this command to disable IPsec protection.

Syntax tunnel protection ipsec [profile <ipsec-profile>]
no tunnel protection ipsec

Parameter	Description
<ipsec-profile>	The name of an optional custom IPsec profile (crypto ipsec profile command) to use to protect this tunnel.

Default IPsec protection for packets encapsulated by tunnel is disabled.

Mode Interface Configuration

Usage notes You also need to configure a pre-shared key in conjunction with this command. See the [crypto isakmp key](#) command for more information about configuring the pre-shared key.

Examples To enable IPsec protection for packets encapsulated by tunnel114, use the commands:

```
awplus#configure terminal
awplus(config)#interface tunnel114
awplus(config-if)#tunnel protection ipsec
```

To disable IPsec protection for packets encapsulated by tunnel114, use the commands:

```
awplus#configure terminal
awplus(config)#interface tunnel114
awplus(config-if)#no tunnel protection ipsec
```

Related commands [crypto ipsec profile](#)
[crypto isakmp key](#)
[show isakmp key \(IPsec\)](#)

tunnel remote id

Overview This command specifies a tunnel remote identifier sent to the peer for match. Use the **no** variant of this command to remove the tunnel remote ID.

Syntax tunnel remote id <1-2147483647>
no tunnel remote id

Parameter	Description
<1-2147483647>	Tunnel ID from 1 through 2147483647

Default No tunnel remote ID is set.

Mode Interface Configuration

Usage notes The endpoints of the tunnel must be configured by mirroring tunnel IDs, that is, the tunnel remote ID on one endpoint must be specified as the tunnel local ID on the other endpoint.

The remote session ID defaults to the tunnel remote ID and the remote session ID is not configurable. A session provides the data channel in L2TPv3. There is a single pseudowire per L2TP session.

Examples To specify a tunnel remote ID, use the commands:

```
awplus#configure terminal
awplus(config)#interface tunnel20
awplus(config-if)#tunnel mode l2tp v3
awplus(config-if)#tunnel remote id 22
```

To remove the tunnel remote ID, use the commands:

```
awplus#configure terminal
awplus(config)#interface tunnel20
awplus(config-if)#no tunnel remote id
```

Related commands [tunnel local id](#)

Validation Commands [show interface tunnel \(L2TPv3\)](#)

tunnel security-reprocessing

Overview Use this command to enable stream security reprocessing on all tunnel interfaces.

Use the **no** variant of this command to disable security reprocessing on all tunnel interfaces.

Note that tunnel security reprocessing increases the load on your device and reduces throughput. This is because traffic is processed twice through the DPI engine. Therefore, it should only be enabled if your solution requires it.

Syntax tunnel security-reprocessing
no tunnel security-reprocessing

Default Security reprocessing is disabled by default.

Mode Global Configuration

Usage notes Use this command when you need to reinspect the traffic in a tunnel terminating on the device using stream UTM features after tunnel headers and encryption have been removed. For a configuration example using this command, see the [Internet Protocol Security \(IPsec\) Feature Overview and Configuration Guide](#).

Example To enable security reprocessing, use the commands:

```
awplus# configure terminal  
awplus(config)# tunnel security-reprocessing
```

To disable security reprocessing, use the commands:

```
awplus# configure terminal  
awplus(config)# no tunnel security-reprocessing
```

Related commands [show interface tunnel \(GRE\)](#)
[show interface tunnel \(IPsec\)](#)
[show interface tunnel \(L2TPv3\)](#)
[show interface tunnel \(OpenVPN\)](#)

Command changes Version 5.4.8-0.2: command added

tunnel source (L2TPv3)

Overview Use this command to specify a tunnel source for the tunnel interface. The tunnel source can be specified by using an interface name or an IPv4 address. The source address must be an existing IPv4 address configured for an interface.

Use the **no** variant of this command to remove a tunnel source for a tunnel interface.

Syntax tunnel source {<ipv4-addr>|<interface-name>}
no tunnel source

Parameter	Description
<ipv4-addr>	Specify the tunnel source IPv4 address for the tunnel interface in the dotted decimal format A.B.C.D. The endpoints of the tunnel must be configured by mirroring IP addresses, that is, the tunnel source on one endpoint must be specified as the tunnel destination on the other endpoint.
<interface-name>	Available interface name. Any AlliedWare Plus interface type (eth, vlan, ppp, tunnel, lo, etc). Using interface name can minimize the number of user-configured IP addresses and allow the tunnel source IP address to be dynamically issued via, for example, DHCP.

Mode Interface Configuration

Examples To configure an L2TPv3 tunnel source IPv4 address, use the commands:

```
awplus# configure terminal
awplus# interface eth1
awplus(config-if)# ip address 1.1.1.1/24
awplus(config-if)# interface tunnel1
awplus(config-if)# tunnel mode l2tp v3
awplus(config-if)# tunnel source 1.1.1.1
```

To use an interface name as the tunnel source, use the commands:

```
awplus# configure terminal
awplus(config)# interface tunnel2
awplus(config-if)# tunnel mode l2tp v3
awplus(config-if)# tunnel source eth2
```

To remove a tunnel source, use the commands:

```
awplus# configure terminal
awplus(config)# interface tunnel1
awplus(config-if)# no tunnel source
```

Related commands interface tunnel (L2TPv3)
tunnel destination (L2TPv3)
tunnel mode l2tp v3

76

Transitioning IPv4 to IPv6 Commands

Introduction

Overview This chapter provides an alphabetical reference of commands used to configure Light Weight 4 over 6 and MAP E.

Many ISPs have migrated from IPv4 to IPv6 networks. However, many customers are still using IPv4 facilities. IPv6 transition technologies, such as Light Weight 4 over 6 (LW4o6) and MAP-E, provide interoperability between IPv4 and IPv6 networks. This enables ISPs with IPv6 networks to provide Internet connectivity to customers with IPv4 facilities.

MAP-E provides a mechanism for mapping between an IPv4 prefix or IPv4 address or IPv4 shared address and an IPv6 address. It also uses the encapsulation mode described in RFC 2473 (IPv6 Tunneling) to transport IPv4 packets over an IPv6 network.

Dual-Stack Lite (DS-Lite) (RFC 6333) describes an architecture for transporting IPv4 packets over an IPv6 network. This chapter describes an extension to DS-Lite called **Lightweight 4over6**, which moves the Network Address and Port Translation (NAPT) function from the centralized DS-Lite tunnel concentrator to the tunnel client located in the Customer Premises Equipment (CPE).

This removes the requirement for a Carrier Grade NAT function in the tunnel concentrator and reduces the amount of centralized state that must be held to a per-subscriber level. In order to delegate the NAPT function and make IPv4 address sharing possible, port-restricted IPv4 addresses are allocated to the CPEs.

- Useful Terms**
- **Softwire:** A tunnel between two IPv6 end-points to carry IPv4 packets or two IPv4 end-points to carry IPV6 packets.
 - **B4:** Softwire at the customer end that encapsulates native packets and tunnels them to a softwire concentrator (AFTR) at the service provider.
 - **AFTR:** Softwire that decapsulates the packets received from a softwire B4 and sends them to their destination.

For more information, see the [Transitioning IPv4 to IPv6 Feature Overview and Configuration Guide](#).

- Command List**
- `br-address (software)` on page 3781
 - `mesh-mode` on page 3782
 - `method (software)` on page 3783
 - `rule (software)` on page 3784
 - `show running-config software-configuration` on page 3786
 - `show software-configuration` on page 3787
 - `software-configuration` on page 3789
 - `tunnel security-reprocessing` on page 3790
 - `tunnel destination (DS-Lite)` on page 3791
 - `tunnel mode ds-lite` on page 3792
 - `tunnel mode lw4o6` on page 3793
 - `tunnel mode map-e` on page 3794
 - `tunnel software` on page 3795
 - `upstream-interface` on page 3796

br-address (software)

Overview Use this command to specify the IPv6 address of the MAP-E Border Router. Note, before using this command you must configure the command **method (Software Configuration)** with the **static** parameter.

Use the **no** variant of this command to remove the MAP-E Border Router address configuration.

Syntax `br-address <ipv6-address>`
`no br-address`

Parameter	Description
<code><ipv6-address></code>	IPv6 address of MAP-E Border Router

Default Not set.

Mode SoftWire Configuration

Example To configure 'swconfig' to the software configuration MAP-E Border Router IPv6 address, use the following commands:

```
awplus# configure terminal
awplus(config)# software-configuration swconfig
awplus(config-software)# br-address 2001::1
```

To remove the MAP-E Border Router IPv6 address configuration for 'swconfig', use the following commands:

```
awplus# configure terminal
awplus(config)# software-configuration swconfig
awplus(config-software)# no br-address
```

Related commands [show software-configuration](#)

Command changes Version 5.4.9-0.1: command added

mesh-mode

Overview Use this command to enable mesh-mode. Mesh-mode enables softwire tunnels to work with devices that share the same IP address at the tunnel endpoint.

Use the **no** variant of this command to disable mesh-mode.

Syntax mesh-mode
no mesh-mode

Default No mesh-mode.

Mode SoftWire Configuration

Usage notes Softwire tunnels may require communication with endpoints sharing the same IP address. The CPU resource required to support this is significant, so this command enables this support.

Example To configure a softwire named 'demo' to communicate with endpoints that share the same IP address, use the following commands:

```
awplus# configure terminal
awplus(config)# softwire-configuration demo
awplus(config-softwire)# mesh-mode
```

Related commands show softwire-configuration
softwire-configuration

Command changes Version 5.4.9-0.1: command added

method (software)

Overview Use this command to specify the configuration method (or source) for a software configuration. The configuration method can be either static or DHCP.

Use the **no** variant of this command to remove a configured method.

Syntax `method {static|dhcp}`
`no method`

Parameter	Description
<code>static</code>	Software configuration is statically configured
<code>dhcp</code>	Software configuration is acquired through DHCP

Default Not set.

Mode SoftWire Configuration

Example To set the 'swconfig' software configuration method to **static**, use the commands:

```
awplus# configure terminal
awplus(config)# software-configuration swconfig
awplus(config-software)# method static
```

To set the 'swconfig' software configuration method to **DHCP**, use the commands:

```
awplus# configure terminal
awplus(config)# software-configuration swconfig
awplus(config-software)# method dhcp
```

To remove the software configuration method from 'swconfig', use the commands:

```
awplus# configure terminal
awplus(config)# software-configuration swconfig
awplus(config-software)# no method
```

Related commands [show software-configuration](#)
[rule \(software\)](#)

Command changes Version 5.4.9-0.1: command added

rule (software)

Overview Use this command to statically configure a MAP rule. Note, before using this command you must configure the command **method (Software Configuration)** with the **static** parameter.

You would normally obtain the values to use in this command from your ISP.

Use the **no** variant of this command to remove a MAP rule configuration.

Syntax

```
rule <0-65535> ipv4-prefix <ipv4-prefix> ipv6-prefix  
<ipv6-prefix> psid-length <0-15> psid <psid-value> [offset  
<0-16>] [forwarding]  
  
rule <0-65535> ipv4-prefix <ipv4-prefix> ipv6-prefix  
<ipv6-prefix> ea-length <0-48> [offset <0-16>] [forwarding]  
  
no rule <0-65535>
```

Parameter	Description
rule <0-65535>	Rule ID is an integer in the range <1-65535>
ipv4-prefix <ipv4-prefix>	IPv4 prefix (e.g. 192.0.2.0/24)
ipv6-prefix <ipv6-prefix>	IPv6 prefix (e.g. 2001:db8::/32)
ea-length <0-48>	Embedded address length is an integer in the range <0-48>.
psid-length <0-15>	Port Set ID (PSID) length is an integer in the range <0-15>, the default length is 0.
psid <psid-value>	Port Set ID (PSID) value is either decimal <0-65535> or hexadecimal with a leading 0x. Different PSID values guarantee non-overlapping port sets.
offset <0-16>	Port Set ID (PSID) offset is an integer in the range <0-16>.
forwarding	Indicates if this rule is a Forwarding Mapping Rule (FMR). Otherwise, this is only used as a Basic Mapping Rule (BMR)

Default Not set.

Mode SoftWire Configuration

Example To configure a MAP rule 1 and MAP rule 2 in Software Configuration 'swconfig', use the following commands:

```
awplus# configure terminal
awplus(config)# software-configuration swconfig
awplus(config-software)# rule 1 ipv4-prefix 192.0.2.0/24
ipv6-prefix 2001:db8:1::/48 ea-length 16 forwarding
awplus(config-software)# rule 2 ipv4-prefix 192.0.2.23/32
ipv6-prefix 2001:db8:1:1781::/64 psid-length 8 psid 129
```

These two example rules above produce the same resulting IPv4 address and PSID if the IPv6 subnet on the upstream interface is 2001:db8:1:1781::/64.

To the remove rule 1 in Software Configuration 'swconfig', use the following commands:

```
awplus# configure terminal
awplus(config)# software-configuration swconfig
awplus(config-software)# no rule 1
```

Related commands [method \(software\)](#)
[show software-configuration](#)

Command changes Version 5.4.9-0.1: command added

show running-config software-configuration

Overview Use this command to display the running configuration information for a software configuration.

Syntax `show running-config software-configuration`
`<software-config-name>`
`show running-config software-configuration`

Parameter	Description
<code><software-config-name></code>	The name assigned for the Software Configuration

Mode Privileged Exec

Example To show the running configuration for **all** software configuration, use the following command:

```
awplus# show running-config software-configuration
```

To show the running configuration for software configuration 'swconfig1', use the following command:

```
awplus# show running-config software-configuration swconfig1
```

Output Figure 76-1: Example output from **show running-config software-configuration**

```
awplus#show running-config software-configuration
software-configuration swconfig1
  method static
  map-version rfc
  br-address 2001:db8:1234:5678::1
  rule 10 ipv4-prefix 192.168.1.0/24 ipv6-prefix 2001:db8:1000::/48 ea-length 16 forwarding
  rule 20 ipv4-prefix 192.168.2.0/24 ipv6-prefix 2001:db8:2000::/48 ea-length 16 forwarding
  rule 30 ipv4-prefix 192.168.3.0/24 ipv6-prefix 2001:db8:3000::/48 ea-length 16 forwarding
!
software-configuration swconfig2
  method dhcp
  upstream-interface eth1
!
```

Related commands [software-configuration](#)

Command changes Version 5.4.9-0.1: command added

show software-configuration

Overview Use this command to show information about the configuration state of software configuration. You can show information for all software configurations or define a specific configuration for display.

Syntax `show software-configuration <software-config-name>`
`show software-configuration`

Parameter	Description
<code><software-config-name></code>	Name assigned to the Software Configuration

Mode Privileged Exec

Example To show information about the configuration state of **all** software configuration, use the command:

```
awplus# show software-configuration
```

To show information about the configuration state of software configuration 'swconfig1', use the command:

```
awplus# show software-configuration swconfig1
```

Output Figure 76-2: Example output for a Static MAP-E software configuration

```
awplus#show software-configuration swconfig1

Software Configuration: swconfig1

Configuration Source: static
Upstream Interface: eth1
MAP-E Version: rfc
No LW4o6 Configuration

Border Relay Device: 2001:db8::1
Rule 0
  IPv4-prefix: 192.0.2.0/24
  IPv6-prefix: 2001:db8::/32
  Embedded address length: 16
  Forwarding: enabled
  PSID offset: default
  PSID length: default
  PSID: default (0x0)
```

Figure 76-3: Example output for LW4o6 (config method DHCP)

```
awplus#show software-configuration

Software Configuration: lw4o6

Configuration Source: dhcp
Upstream Interface: eth1
MAP-E Version: rfc
lwAFTR Address: 2001:0db8:acc3:0055:0000:0000:0000:0001
lw4o6 Rule:
  IPv4-Address: 192.0.2.123
  IPv6-Prefix: 2001:0db8::/32
  PSID offset: 0
  PSID length: 9
  PSID: 346 (0x15a)

Border Relay Device: Not Set
```

Related commands

- [software-configuration](#)
- [method \(software\)](#)
- [br-address \(software\)](#)
- [upstream-interface](#)
- [rule \(software\)](#)

Command changes Version 5.4.9-0.1: command added

software-configuration

Overview Use this command to enter the Software Configuration mode. This mode allows you to configure software settings.

In computer networking, a software is a type of tunneling protocol that creates a virtual "wire" that transparently encapsulates another protocol. Softwares are used for various purposes, one of which is to carry IPv4 traffic over IPv6 and vice versa, in order to support IPv6 transition mechanisms.

Use the **no** variant of this command to remove a software configuration.

Syntax `software-configuration <software-config-name>`
`no software-configuration <software-config-name>`

Parameter	Description
<code><software-config-name></code>	The name assigned for this software configuration

Mode Global Configuration

Example To configure software settings for 'software1', use the following commands:

```
awplus# configure terminal
awplus(config)# software-configuration software1
awplus(config-software)#
```

To remove software 'software1', MAP Rules configuration, use the following commands:

```
awplus# configure terminal
awplus(config)# no software-configuration software1
```

Related commands [show software-configuration](#)

Command changes Version 5.4.9-0.1: command added

tunnel security-reprocessing

Overview Use this command to enable stream security reprocessing on all tunnel interfaces.

Use the **no** variant of this command to disable security reprocessing on all tunnel interfaces.

Note that tunnel security reprocessing increases the load on your device and reduces throughput. This is because traffic is processed twice through the DPI engine. Therefore, it should only be enabled if your solution requires it.

Syntax tunnel security-reprocessing
no tunnel security-reprocessing

Default Security reprocessing is disabled by default.

Mode Global Configuration

Usage notes Use this command when you need to reinspect the traffic in a tunnel terminating on the device using stream UTM features after tunnel headers and encryption have been removed. For a configuration example using this command, see the [Internet Protocol Security \(IPsec\) Feature Overview and Configuration Guide](#).

Example To enable security reprocessing, use the commands:

```
awplus# configure terminal
awplus(config)# tunnel security-reprocessing
```

To disable security reprocessing, use the commands:

```
awplus# configure terminal
awplus(config)# no tunnel security-reprocessing
```

Related commands [show interface tunnel \(GRE\)](#)
[show interface tunnel \(IPsec\)](#)
[show interface tunnel \(L2TPv3\)](#)
[show interface tunnel \(OpenVPN\)](#)

Command changes Version 5.4.8-0.2: command added

tunnel destination (DS-Lite)

Overview Use this command to specify the tunnel destination for a DS-Lite tunnel.
Use the **no** variant of this command to remove a configured tunnel destination.

Syntax tunnel destination dhcp interface <interface-name>
no tunnel destination

Parameter	Description
<interface-name>	The interface which receives the DHCP reply.

Mode Interface Configuration

Example To configure a DS-Lite tunnel destination, use the following commands:

```
awplus# configure terminal
awplus(config)# interface tunnel0
awplus(config-if)# tunnel mode ds-lite
awplus(config-if)# tunnel destination dhcp interface eth1
```

To remove the tunnel destination, use the following commands:

```
awplus# configure terminal
awplus(config)# interface tunnel0
awplus(config-if)# no tunnel mode destination
```

Related commands [tunnel mode ds-lite](#)

Command changes Version 5.4.9-0.1: command added

tunnel mode ds-lite

Overview Use this command to set the tunnel mode to DS-Lite for a tunnel interface.
Use the **no** variant of this command to remove the tunnel mode.

Syntax tunnel mode ds-lite
no tunnel mode

Default Not set.

Mode Interface Configuration

Example To configure the DS-Lite tunnel mode on interface 'tunnel0', use the following commands:

```
awplus# configure terminal
awplus(config)# interface tunnel0
awplus(config-if)# tunnel mode ds-lite
```

To remove the configured DS-Lite tunnel mode for 'tunnel0', use the following commands:

```
awplus# configure terminal
awplus(config)# interface tunnel0
awplus(config-if)# no tunnel mode
```

Related commands [tunnel mode \(IPv6\)](#)

Command changes Version 5.4.9-0.1: command added

tunnel mode lw4o6

Overview Use this command to set the tunnel mode to Light Weight 4over6 (lw4o6) for a tunnel interface.

Use the **no** variant of this command to remove an established lw4o6 tunnel.

Syntax tunnel mode lw4o6
no tunnel mode

Default Not set.

Mode Interface Configuration

Example To configure lw4o6 tunnel mode for tunnel6, use the following commands:

```
awplus# configure terminal
awplus(config)# interface tunnel6
awplus(config-if)# tunnel mode lw4o6
```

To removed the configured lw4o6 tunnel mode for tunnel6, use the following commands:

```
awplus# configure terminal
awplus(config)# interface tunnel6
awplus(config-if)# no tunnel mode
```

Related commands [tunnel mode \(IPv6\)](#)

Command changes Version 5.4.9-0.1: command added

tunnel mode map-e

Overview Use this command to set the tunnel mode to MAP-E for a tunnel interface.
Use the **no** variant of this command to remove the MAP-E mode from a tunnel interface.

Syntax tunnel mode map-e
no tunnel mode

Default Not set.

Mode User Exec and Privileged Exec

Example To configure the MAP-E tunnel mode on interface 'tunnel6', use the following commands:

```
awplus# configure terminal
awplus(config)# interface tunnel6
awplus(config-if)# tunnel mode map-e
```

To remove the configured MAP-E tunnel mode for 'tunnel6', use the following commands:

```
awplus# configure terminal
awplus(config)# interface tunnel6
awplus(config-if)# no tunnel mode
```

Related commands [show software-configuration](#)

Command changes Version 5.4.9-0.1: command added

tunnel software

Overview Use this command to configure the software configuration to use for a tunnel interface.

Note that **tunnel-mode map-e** or **tunnel mode lw4o6** must be configured in order for the command **tunnel software** to be valid.

Use the **no** variant of this command to remove a tunnel software configuration.

Syntax tunnel software <software-config-name>
no tunnel software

Parameter	Description
<software-config-name>	The software configuration used for a tunnel interface

Default Not set.

Mode Interface Configuration

Example To set the software configuration called 'swconfig' to an interface called 'tunnel6', use the following commands:

```
awplus# configure terminal  
awplus(config)# interface tunnel6  
awplus(config-if)# tunnel software swconfig
```

To remove the software configuration for interface 'tunnel6', use the following commands:

```
awplus# configure terminal  
awplus(config)# interface tunnel6  
awplus(config-if)# no tunnel software
```

Related commands tunnel mode map-e
tunnel mode lw4o6

Command changes Version 5.4.9-0.1: command added

upstream-interface

Overview Use this command to assign a software configuration to an upstream interface configured with a globally scoped IPv6 address.
Use the **no** variant of this command to remove a configured upstream interface.

Syntax `upstream-interface <interface-name>`
`no upstream-interface`

Parameter	Description
<code><interface-name></code>	Name of the interface connected to upstream (e.g. eth1, br1, vlan1)

Default Not set.

Mode SoftWire Configuration

Example To configure the software configuration ('swconfig') upstream-interface to eth1, use the following commands:

```
awplus# configure terminal
awplus(config)# software-configuration swconfig
awplus(config-software)# upstream-interface eth1
```

To remove the software configuration ('swconfig') upstream-interface configuration, use the following commands:

```
awplus# configure terminal
awplus(config)# software-configuration swconfig
awplus(config-software)# no upstream-interface
```

Related commands [show software-configuration](#)

Command changes Version 5.4.9-0.1: command added

77

IPv6 Tunneling Commands

Introduction

Overview This chapter provides an alphabetical reference of commands used to configure IPv6 Tunneling.

For more information, see the [IPv6 Tunneling Feature Overview and Configuration Guide](#).

- Command List**
- ["interface tunnel \(IPv6\)"](#) on page 3798
 - ["ip address \(IP Addressing and Protocol\)"](#) on page 3799
 - ["ip tcp adjust-mss"](#) on page 3801
 - ["ipv6 address"](#) on page 3803
 - ["ipv6 tcp adjust-mss"](#) on page 3805
 - ["mtu"](#) on page 3807
 - ["show interface tunnel \(IPv6\)"](#) on page 3809
 - ["tunnel destination \(IPv6\)"](#) on page 3810
 - ["tunnel dscp"](#) on page 3812
 - ["tunnel mode \(IPv6\)"](#) on page 3813
 - ["tunnel source \(IPv6\)"](#) on page 3814
 - ["tunnel ttl"](#) on page 3816

interface tunnel (IPv6)

Overview Use this command to create a tunnel interface or to enter Interface mode to configure an existing tunnel. Tunnel interfaces are identified by an index identifier that is an integer in the range from 0 through 65535.

Use the **no** variant of this command to remove a previously created tunnel interface.

Syntax `interface tunnel< tunnel-index >`
`no interface tunnel< tunnel-index >`

Parameter	Description
<code>< tunnel-index ></code>	Specify a tunnel interface index identifier in the range from 0 through 65535.

Default Tunnel interfaces do not exist.

Mode Global Configuration

Usage notes After you have created the tunnel interface, use the **tunnel mode** command to enable the tunnel.

Examples To configure a tunnel interface with index 30 and use IPv6 tunneling, use the commands:

```
awplus# configure terminal
awplus(config)# interface tunnel30
awplus(config-if)# tunnel mode ipv6
```

To remove the IPv6 tunnel interface tunnel30, use the commands:

```
awplus# configure terminal
awplus(config)# no interface tunnel30
```

Command changes Version 5.4.8-2.1: command added

ip address (IP Addressing and Protocol)

Overview This command sets a static IP address on an interface.

The **no** variant of this command removes the IP address from the interface.

You cannot remove the primary address when a secondary address is present.

Syntax `ip address <ip-addr/prefix-length> [secondary] [label <label>]`
`no ip address [<ip-addr/prefix-length>] [secondary]`

Parameter	Description
<ip-addr/prefix-length>	The IPv4 address and prefix length you are assigning to the interface.
secondary	Secondary IP address.
label	Adds a user-defined description of the secondary IP address.
<label>	A user-defined description of the secondary IP address. Valid characters are any printable character and spaces.

Mode Interface Configuration for a VLAN interface, an Eth interface, an 802.1Q sub-interface, a local loopback interface, a PPP interface, a bridge, or a tunnel.

Usage notes To set the primary IP address on the interface, specify only **ip address** <ip-addr/prefix-length>. This overwrites any configured primary IP address. To add additional IP addresses on this interface, use the **secondary** parameter. You must configure a primary address on the interface before configuring a secondary address.

NOTE: Use **show running-config interface**, instead of **show ip interface brief**, when you need to view a secondary address configured on an interface. **show ip interface brief** will only show the primary address, not a secondary address for an interface.

Examples To add the IP address 10.10.10.50/24 to the interface vlan2, use the following commands:

```
awplus# configure terminal
awplus(config)# interface vlan2
awplus(config-if)# ip address 10.10.10.50/24
```

To add the secondary IP address 10.10.11.50/24 to the same interface, use the following commands:

```
awplus# configure terminal
awplus(config)# interface vlan2
awplus(config-if)# ip address 10.10.11.50/24 secondary
```

To add the IP address 10.10.11.50/24 to the local loopback interface lo, use the following commands:

```
awplus# configure terminal
awplus(config)# interface lo
awplus(config-if)# ip address 10.10.11.50/24
```

To add the IP address 10.10.11.50/24 to the PPP interface ppp0, use the following commands:

```
awplus# configure terminal
awplus(config)# interface ppp0
awplus(config-if)# ip address 10.10.11.50/24
```

To add the IP address 10.10.11.50/24 to the tunnel tunnel0, use the following commands:

```
awplus# configure terminal
awplus(config)# interface tunnel0
awplus(config-if)# ip address 10.10.11.50/24
```

**Related
commands**

[interface \(to configure\)](#)
[show ip interface](#)
[show running-config interface](#)

ip tcp adjust-mss

Overview Use this command to set the Maximum Segment Size (MSS) size for an interface, where MSS is the maximum TCP data packet size that the interface can transmit before fragmentation.

Use the **no** variant of this command to remove a previously specified MSS size for a PPP interface, and restore the default MSS size.

Syntax `ip tcp adjust-mss {<mss-size>|pmtu}`
`no ip tcp adjust-mss`

Parameter	Description
<mss-size>	<64-1460> Specifies the MSS size in bytes.
pmtu	Adjust TCP MSS automatically with respect to the MTU on the interface.

Default The default setting allows a TCP server or a TCP client to set the MSS value for itself.

Mode Interface Configuration

Usage notes When a host initiates a TCP session with a server it negotiates the IP segment size by using the MSS option field in the TCP packet. The value of the MSS option field is determined by the Maximum Transmission Unit (MTU) configuration on the host.

You can set a feasible MSS value on the following interfaces:

- PPP
- Ethernet
- Tunnel
- VLAN

Examples To configure an MSS size of 1452 bytes on PPP interface ppp0, use the commands:

```
awplus# configure terminal
awplus(config)# interface ppp0
awplus(config-if)# ip tcp adjust-mss 1452
```

To configure an MSS size of 1452 bytes on Ethernet interface eth1, use the commands:

```
awplus# configure terminal
awplus(config)# interface eth1
awplus(config-if)# ip tcp adjust-mss 1452
```

To configure an MSS size of 1452 bytes on interface tunnel2, use the commands:

```
awplus# configure terminal
awplus(config)# interface tunnel2
awplus(config-if)# ip tcp adjust-mss 1452
```

To restore the MSS size to the default size on PPP interface ppp0, use the commands:

```
awplus# configure terminal
awplus(config)# interface ppp0
awplus(config-if)# no ip tcp adjust-mss
```

**Related
commands**

[mtu \(PPP\)](#)
[show interface](#)
[show interface \(PPP\)](#)
[show interface tunnel \(GRE\)](#)

**Command
changes**

Version 5.4.8-2.1: interface tunnel example added

ipv6 address

Overview Use this command to set the IPv6 address of an interface. The command also enables IPv6 on the interface, which creates an EUI-64 link-local address as well as enabling RA processing and SLAAC.

To stop the device from processing prefix information (routes and addresses from the received Router Advertisements) use the command **no ipv6 nd accept-ra-pinfo**.

To remove the EUI-64 link-local address, use the command **no ipv6 eui64-linklocal**.

Use the **no** variant of this command to remove the IPv6 address assigned and disable IPv6. Note that if no global addresses are left after removing the IPv6 address then IPv6 is disabled.

Syntax `ipv6 address <ipv6-addr/prefix-length>`
`no ipv6 address <ipv6-addr/prefix-length>`

Parameter	Description
<code><ipv6-addr/prefix-length></code>	Specifies the IPv6 address to be set. The IPv6 address uses the format X:X::X/Prefix-Length. The prefix-length is usually set between 0 and 64.

Mode Interface Configuration for a VLAN interface, an Eth interface, an 802.1Q sub-interface, a local loopback interface, a PPP interface, a bridge, or a tunnel.

Usage notes Note that the device keeps link-local addresses until you remove them with the **no** variant of the command that established them. See the [ipv6 enable](#) command for more information.

Also note that the device keeps the link-local address if the global address is removed using a command other than the command that was used to establish the link-local address. For example, if a link local address is established with the [ipv6 enable](#) command then it will not be removed using a **no ipv6 address** command.

Examples To assign the IPv6 address 2001:0db8::a2/64 to eth1, use the commands:

```
awplus# configure terminal
awplus(config)# interface eth1
awplus(config-if)# ipv6 address 2001:0db8::a2/64
```

To remove the IPv6 address 2001:0db8::a2/64 from eth1, use the commands:

```
awplus# configure terminal
awplus(config)# interface eth1
awplus(config-if)# no ipv6 address 2001:0db8::a2/64
```

To assign the IPv6 address to the PPP interface ppp0, use the commands:

```
awplus# configure terminal
awplus(config)# interface ppp0
awplus(config-if)# ipv6 address 2001:0db8::a2/64
```

To assign the IPv6 address to the tunnel tunnel0, use the commands:

```
awplus# configure terminal
awplus(config)# interface tunnel0
awplus(config-if)# ipv6 address 2001:0db8::a2/64
```

To remove the IPv6 address 2001:0db8::a2/64 from the PPP interface ppp0, use the commands:

```
awplus# configure terminal
awplus(config)# interface ppp0
awplus(config-if)# no ipv6 address 2001:0db8::a2/64
```

**Related
commands**

[ipv6 address autoconfig](#)

[ipv6 address dhcp](#)

[ipv6 dhcp server](#)

[ipv6 enable](#)

[ipv6 eui64-linklocal](#)

[show running-config](#)

[show ipv6 interface](#)

[show ipv6 route](#)

ipv6 tcp adjust-mss

Overview Use this command to set the IPv6 Maximum Segment Size (MSS) size for an interface, where MSS is the maximum TCP data packet size that the interface can transmit before fragmentation.

Use the **no** variant of this command to remove a previously specified MSS size for a PPP interface, and restore the default MSS size.

Syntax `ipv6 tcp adjust-mss {<mss-size>|pmtu}`
`no ipv6 tcp adjust-mss`

Parameter	Description
<code><mss-size></code>	<code><64-1460></code> Specifies the MSS size in bytes.
<code>pmtu</code>	Adjust TCP MSS automatically with respect to the MTU on the interface.

Default The default setting allows a TCP server or a TCP client to set the MSS value for itself.

Mode Interface Configuration

Usage notes When a host initiates a TCP session with a server it negotiates the IP segment size by using the MSS option field in the TCP packet. The value of the MSS option field is determined by the Maximum Transmission Unit (MTU) configuration on the host.

You can set a feasible MSS value on the following interfaces:

- PPP
- Ethernet
- Tunnel
- VLAN

Examples To configure an IPv6 MSS size of 1452 bytes on PPP interface ppp0, use the commands:

```
awplus# configure terminal
awplus(config)# interface ppp0
awplus(config-if)# ipv6 tcp adjust-mss 1452
```

To configure an IPv6 MSS size of 1452 bytes on Ethernet interface eth1, use the commands:

```
awplus# configure terminal
awplus(config)# interface eth1
awplus(config-if)# ipv6 tcp adjust-mss 1452
```

To adjust IPv6 TCP MSS automatically with respect to the MTU on interface tunnel2, use the commands:

```
awplus# configure terminal
awplus(config)# interface tunnel2
awplus(config-if)# ipv6 tcp adjust-mss pmtu
```

To restore the MSS size to the default size on PPP interface ppp0, use the commands:

```
awplus# configure terminal
awplus(config)# interface ppp0
awplus(config-if)# no ipv6 tcp adjust-mss
```

**Related
commands**

[mtu \(PPP\)](#)
[show interface](#)
[show interface \(PPP\)](#)
[show interface tunnel \(GRE\)](#)

**Command
changes**

Version 5.4.8-2.1: interface tunnel example added

mtu

Overview Use this command to set the Maximum Transmission Unit (MTU) size for interfaces, where MTU is the maximum packet size that interfaces can transmit. The MTU size setting is applied to both IPv4 and IPv6 packet transmission.

Use the **no** variant of this command to remove a previously specified Maximum Transmission Unit (MTU) size, and restore the default MTU size. For example, the VLAN interface default is 1500 bytes.

Syntax `mtu <68-1582>`
`no mtu`

Parameter	Description
<code><68-1582></code>	The Maximum Transmission size in bytes.

Default The default MTU size, for example 1500 bytes for VLAN interfaces.

Mode Interface Configuration

Usage notes If a device receives an IPv4 packet for Layer 3 switching to another interface with an MTU size smaller than the packet size, and if the packet has the **'don't fragment'** bit set, then the device will send an ICMP **'destination unreachable'** (3) packet type and a **'fragmentation needed and DF set'** (4) code back to the source. For IPv6 packets bigger than the MTU size of the transmitting interface, an ICMP **'packet too big'** (ICMP type 2 code 0) message is sent to the source.

You can set an MTU value on the following interfaces:

- PPP
- Ethernet
- Tunnel
- VLAN

Note that you cannot configure MTU on bridge interfaces. The MTU of the bridge interface is determined by the member interface of the bridge which has the lowest MTU. For example, if you attach eth1 with MTU 1200, ppp1 with MTU 1400, and vlan1 with MTU 1500 to a bridge interface, the MTU for that interface will be 1200.

Note that `show interface` output will only show MTU size for VLAN interfaces.

Examples To configure an MTU size of 1555 bytes on vlan2, use the commands:

```
awplus# configure terminal
awplus(config)# interface vlan2
awplus(config-if)# mtu 1555
```

To configure an MTU size of 1555 bytes for tunnel 'tunnel2', use the commands:

```
awplus# configure terminal
awplus(config)# interface tunnel2
awplus(config-if)# mtu 1555
```

To restore the MTU size to the default MTU size of 1500 bytes on vlan2, use the commands:

```
awplus# configure terminal
awplus(config)# interface vlan2
awplus(config-if)# no mtu
```

Related commands [show interface](#)

Command changes Version 5.4.7-1.1: Behavior change when MTU set to less than 1500 on FS980M and GS980M.

Version 5.5.1-0.1: Layer 3 jumbo frames supported on SBx908 GEN2 and x950.

Version 5.5.1-1.2: Layer 3 jumbo frames supported on x530 and GS980MX.

show interface tunnel (IPv6)

Overview Use this command to display status information of tunnels.

The tunnel remains inactive if no valid tunnel source or tunnel destination is configured.

Syntax `show interface tunnel<tunnel-index>`

Parameter	Description
tunnel	Specify this parameter to display tunnel status information of a given tunnel identified by the <0-255> parameter.
<0-255>	Specify a tunnel index in the range from 0 through 255.

Mode Privileged Exec

Example To display status information for IPv6 tunnel tunnel120, use the command:

```
awplus# show interface tunnel120
```

Figure 77-1: Example output from the **show interface tunnel** command

```
awplus#show interface tunnel120
Interface tunnel120
  Link is UP, administrative state is UP
  Hardware is Tunnel
  IPv4 address 192.168.10.1/24 pointopoint 192.168.10.255
  index 4751 metric 1 mtu 1480
  arp ageing timeout 300
  <UP,POINTOPOINT,RUNNING,MULTICAST>
  SNMP link-status traps: Disabled
  Tunnel source 2001:db8::1:1, destination 2001:db8::2:1
  Tunnel name local 2001:db8::1:1, remote 2001:db8::2:1
  Tunnel ID local (not set), remote (not set)
  Tunnel protocol/transport ipv6, key disabled, sequencing disabled
  Tunnel TTL 64
  Checksumming of packets disabled, path MTU discovery disabled
  input packets 0, bytes 0, dropped 0, multicast packets 0
  output packets 0, bytes 0, multicast packets 0 broadcast packets 0
  Time since last state change: 0 days 22:38:35
```

Command changes Version 5.4.8-2.1: command added

tunnel destination (IPv6)

Overview Use this command to specify a tunnel destination for the remote end of the tunnel. Tunnel destination can be specified by using a destination network name or an IPv6 address.

Use the **no** variant of this command to remove a configured tunnel destination.

Syntax tunnel destination {<ipv6-addr>|<destination-network-name>}
no tunnel destination

Parameter	Description
<ipv6-addr>	Specify the tunnel destination IPv6 address in the dotted decimal format x:x::x:x. The endpoints of the tunnel must be configured by mirroring IP addresses, that is, the tunnel source on one endpoint must be specified as the tunnel destination on the other endpoint.
<destination-network-name>	Destination network name. If the destination network name cannot be resolved, then the IPv6 tunnel remains inactive.

Mode Interface Configuration

Examples To configure an IPv6 tunnel destination by using an IPv6 address, use the commands:

```
awplus# configure terminal
awplus(config)# interface tunnel40
awplus(config-if)# tunnel mode ipv6
awplus(config-if)# tunnel destination 2001:db8::1:1
```

To configure an IPv6 tunnel destination by using a destination network name, use the commands:

```
awplus# configure terminal
awplus(config)# interface tunnel40
awplus(config-if)# tunnel mode ipv6
awplus(config-if)# tunnel destination
corporate_lan.example.com
```

To remove a IPv6 tunnel destination, use the commands:

```
awplus# configure terminal
awplus(config)# interface tunnel40
awplus(config-if)# no tunnel destination
```

Related commands [interface tunnel \(IPv6\)](#)

tunnel mode (IPv6)

tunnel source (IPv6)

Command changes Version 5.4.8-2.1: command added

tunnel dscp

Overview Use this command to configure the Differentiated Services Code Point (DSCP) value for the DSCP field in the packet header that encapsulates the tunneled packets.

Use the **no** variant of this command to reset the DSCP field to its default value.

Syntax tunnel dscp <0-63>
no tunnel dscp

Parameter	Description
<0-63>	Specify the DSCP value in the range from 0 through 63 for the DSCP field in the packet header that encapsulates the tunneled packets.

Default The IPv4 DSCP field value is inherited from the inner header to the outer header.

Mode Interface Configuration

Examples To configure the DSCP value to 10 for tunnel2, use the commands:

```
awplus# configure terminal
awplus(config)# interface tunnel2
awplus(config-if)# tunnel dscp 10
```

To remove a configured DSCP value for tunnel2, use the commands:

```
awplus# configure terminal
awplus(config)# interface tunnel2
awplus(config-if)# no tunnel dscp
```

Related commands [interface tunnel \(IPv6\)](#)
[interface tunnel \(GRE\)](#)

tunnel mode (IPv6)

Overview Use this command to configure the encapsulation tunneling mode to use. This command sets IPv6 tunneling.

Use the **no** variant of this command to remove an established tunnel.

Syntax `tunnel mode ipv6`
`no tunnel mode`

Default Virtual tunnel interfaces have no mode set by default.

Mode Interface Configuration

Usage notes A tunnel will not become operational until it is configured with this command.

Examples To configure IPv6 as the encapsulation mode for tunnel2, use the commands:

```
awplus# configure terminal
awplus(config)# interface tunnel2
awplus(config-if)# tunnel mode ipv6
```

To remove a configured IPv6 tunnel mode for tunnel2, use the commands:

```
awplus# configure terminal
awplus(config)# interface tunnel2
awplus(config-if)# no tunnel mode
```

Related commands [interface tunnel \(IPv6\)](#)

Command changes Version 5.4.8-2.1: command added

tunnel source (IPv6)

Overview Use this command to specify a tunnel source for the tunnel interface. Tunnel source can be specified by using an interface name or an IPv6 address. The source address must be an existing IPv6 address configured for an interface.

Use the **no** variant of this command to remove a tunnel source for a tunnel interface.

Syntax tunnel source {<ipv6-addr>|<interface-name>}
no tunnel source

Parameter	Description
<ipv6-addr>	Specify the tunnel source IPv6 address for the IPv6 tunnel interface in the dotted decimal format x::x:x. The endpoints of the tunnel must be configured by mirroring IP addresses, that is, the tunnel source on one endpoint must be specified as the tunnel destination on the other endpoint.
<interface-name>	Available interface name. Any AlliedWare Plus interface type (eth, vlan, ppp, tunnel, lo, etc). Using interface name can minimize the number of user-configured IP addresses and allow the tunnel source IP address to be dynamically issued via, for example, DHCP.

Mode Interface Configuration

Examples To configure an IPv6 tunnel source IPv6 address, use the commands:

```
awplus# configure terminal
awplus# interface eth1
awplus(config-if)# ip address 2001:db8::1:1/48
awplus(config-if)# interface tunnel1
awplus(config-if)# tunnel mode ipv6
awplus(config-if)# tunnel source 2001:db8::1:1
```

To use an interface name as the tunnel source, use the commands:

```
awplus# configure terminal
awplus(config)# interface tunnel2
awplus(config-if)# tunnel mode ipv6
awplus(config-if)# tunnel source eth1
```

To remove an IPv6 tunnel source, use the commands:

```
awplus# configure terminal
awplus(config)# interface tunnel1
awplus(config-if)# no tunnel source
```

Related commands interface tunnel (IPv6)
tunnel destination (IPv6)
tunnel mode (IPv6)

Command changes Version 5.4.8-2.1: command added

tunnel ttl

Overview Use this command to configure the value to use for the Time to Live (TTL) field in the IPv4 header that encapsulates the tunneled IPv4 or IPv6 packets.

Use the **no** variant of this command to set the TTL value to its default.

Syntax tunnel ttl <1-255>
no tunnel ttl

Parameter	Description
<1-255>	TTL value from 1 through 255.

Default The default TTL value is inherited from the encapsulated packet.

Mode Interface Configuration

Example To set the TTL value of the packet to 255, use the commands:

```
awplus# configure terminal
awplus(config)# interface tunnel120
awplus(config-if)# tunnel ttl 255
```

To remove the configured TTL value of the packet, use the commands:

```
awplus# configure terminal
awplus(config)# interface tunnel120
awplus(config-if)# no tunnel ttl
```

Related commands [interface tunnel \(IPv6\)](#)
[interface tunnel \(GRE\)](#)